

# KitchenAid® Installation Instructions

## Undercounter/Freestanding Compactor

### IMPORTANT

**Installer:** Leave Installation Instructions with the homeowner.

**Homeowner:** Keep Installation Instructions for future reference. Save Installation Instructions for local electrical inspector's use.

### Before you start...

Proper installation is your responsibility. Make sure you have everything necessary for correct installation. It is the personal responsibility and obligation of the customer to contact a qualified installer to assure that electrical installation meets national and local codes and ordinances.

Grounded electrical outlet is required. See Electrical requirements.

Check the location where your compactor will be installed. The cabinet opening should be square. You should be able to fully open the compactor drawer. Six inches (15.2cm) clearance is needed on the right side of compactor drawer to be able to remove compactor bag.

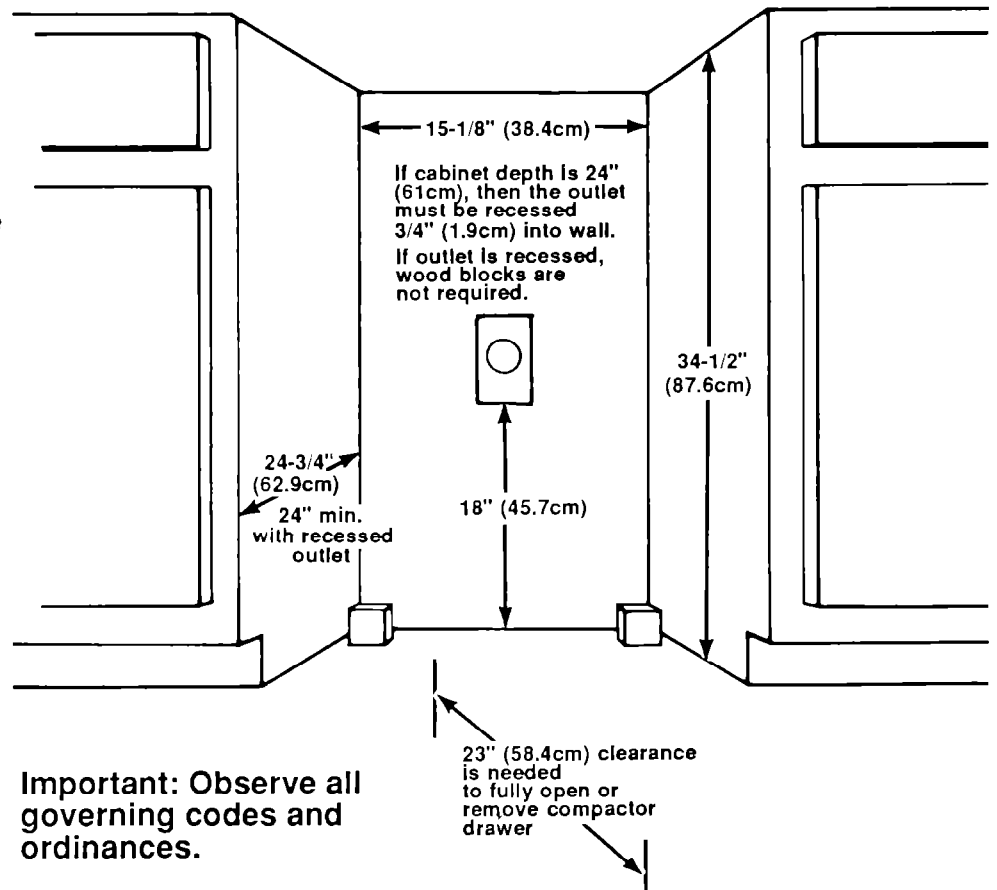

### ⚠ WARNING

#### Fire Hazard

Do not let any item fall or collect behind the compactor. To do so may result in a fire.

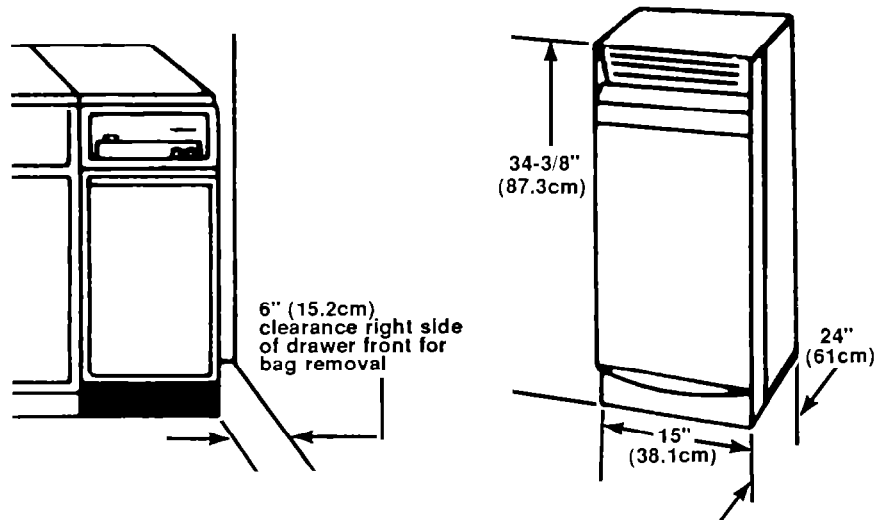

## Tools and materials needed for installation:

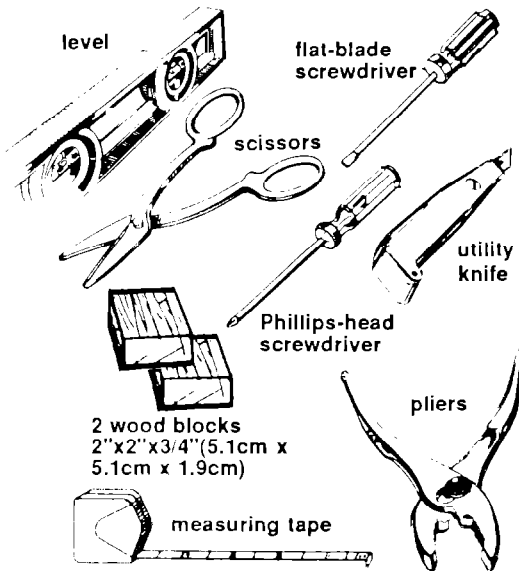

## Electrical requirements

### ⚠ WARNING

#### Electrical Shock Hazard

- Electrical ground is required on this appliance.

Improper connection of the equipment-grounding conductor line can result in electrical shock.

Check with a qualified electrician if you are in doubt as to whether the appliance is properly grounded. Do Not modify the plug on the power supply cord. If it will not fit the outlet, have a proper outlet installed by a qualified electrician.

- Do Not use an extension cord with this appliance. Such use may result in a fire, electrical shock or other personal injury.
- Do Not have a fuse in the neutral or grounding circuit. This could result in electrical shock.

A 230-volt, 50 Hz, AC only, 5 ampere fused electrical supply is required. Time-delay fuse or circuit breaker is recommended. It is recommended that a separate circuit serving only this appliance be provided.

## Recommended grounding method

Do Not, under any circumstances, remove the power supply cord grounding prong.

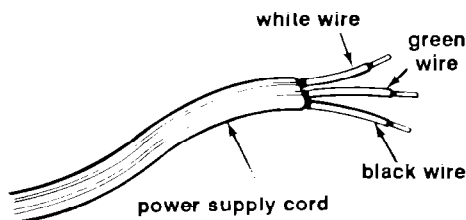

For your personal safety, this appliance must be grounded. This appliance is equipped with a power supply cord that ends with three wires. You must supply and install the proper plug. To minimize possibility of electrical shock, the cord must be plugged into a mating 3-prong, grounding-type wall receptacle, grounded in accordance with local codes and ordinances. If a mating wall receptacle is not available, it is the personal responsibility and obligation of the customer to have a properly grounded, 3-prong wall receptacle installed by a qualified electrician.

## Now start...

with compactor in room where it will be installed.

1. Remove compactor from shipping carton. Remove all shipping materials from compactor. Waxy residue from protective shipping materials can be removed using a mild household cleanser and water.

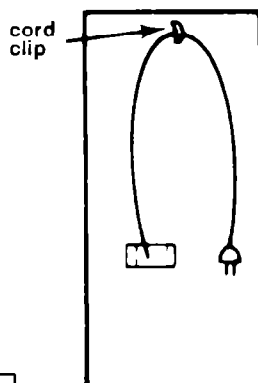

2. Check that power supply cord is attached to the cord clip on the rear of the compactor.

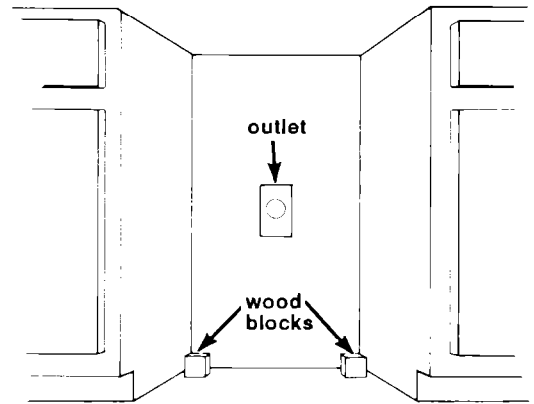

3. If needed, install the two wood blocks on the floor in the rear corners of the cabinet opening. The blocks are required to prevent the compactor from crushing or pinching the power supply cord when the compactor is placed in the cabinet opening.

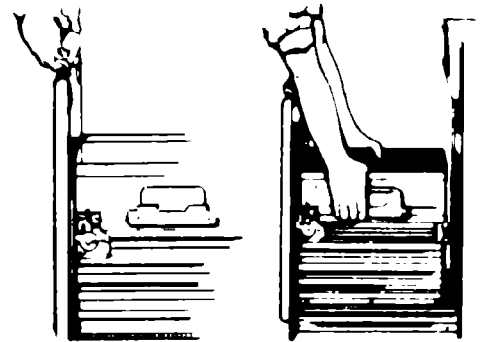

4. Open compactor drawer and remove any shipping materials or other items shipped in the drawer. Grasp handle and raise front of drawer until it clears drawer stops. Grasp sides of drawer and lift drawer out of compactor. Place the drawer on two of the corner posts from the carton.

### ⚠ CAUTION

#### Potential Product/Floor Damage

- Do Not grasp console to move compactor. To do so may damage the console area.
- Slide compactor onto cardboard or hardboard before moving.

Failure to do so may cause damage to floor covering.

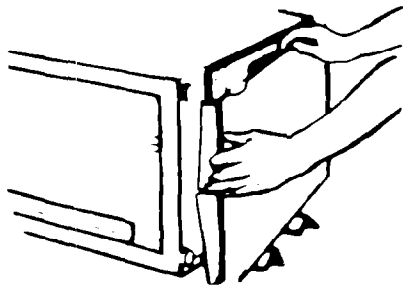

**5.** Place two corner posts on the floor to the side of the compactator. Grasp the sides of the compactator cabinet and put compactator on its side on top of the corner posts. Remove the shipping base.

**6.** Use pliers to lower leveling feet away from cabinet. Stand the compactator upright.

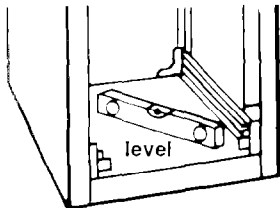

**7.** Place level inside on the floor of the cabinet. Check that the compactator is level from front to back and from side to side. Adjust the four leveling legs until the compactator is level.

**8.** If your compactator is a freestanding model, go to step 10. Remove the plastic plugs from the undercounter compactator top.

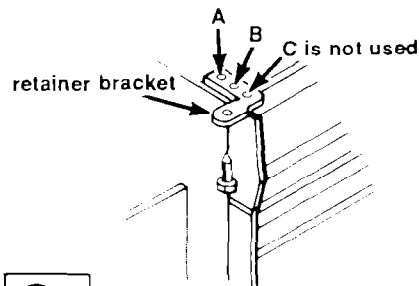

**9.** Determine if you want the compactator drawer front or the frame flush with the cabinet front. If the drawer front is to be flush with the cabinet front, attach the retainer brackets by placing the screw through "A". If the frame is to be flush with the cabinet front, place the screw through "B".

**10.** Plug power cord into electrical outlet. Move compactator cabinet into final position against the wood blocks.

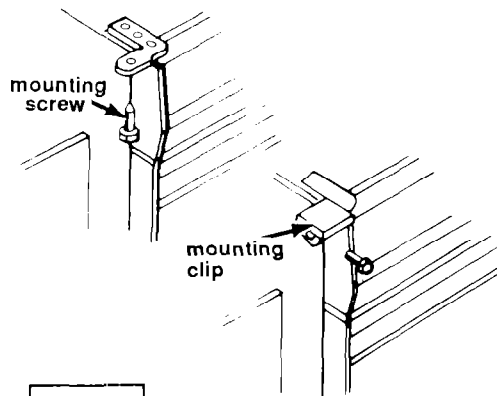

**11.** If your compactator is a freestanding model, go to step 12. Attach the undercounter compactator retainer brackets to the underside of the countertop. Check that compactator is still level. (See step 7)

If brackets cannot be attached to the underside of countertop, use mounting clips.

**12.** Grasp sides of drawer and place bottom of drawer into tracks. Lift at the handle so the front of drawer will go over drawer stops. Close drawer.

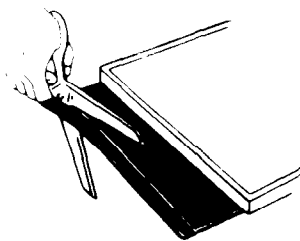

**13.** Open drawer and check if toe plate is rubbing against the floor. If the toe plate is rubbing, mark on each side of the toe plate where it will need to be cut. Place corner posts in front of compactator on the floor. Remove drawer as explained in step 4. Place the rear of the drawer on the corner posts so the drawer front faces up. Draw a line between the marks on each side of toe plate. Use scissors or utility knife to cut toe plate along line. Replace drawer as explained in step 12.

**14.** Read Operating Instructions to operate and care for your compactator efficiently. Keep all literature in a safe place for future reference. Keep extra key knob in a safe place.

## Changing color panel.

Your compactator has three reversible color panels which offer you a choice of six colors: Harvest Gold, Black, Almond, White, Platinum and Toast.

### ⚠ WARNING

**Personal Injury Hazard**  
Handle metal edges of panels carefully. Cut metal edges may cause personal injury or damage to other materials.

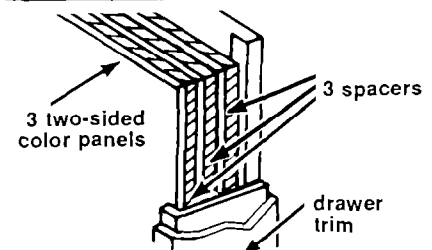

1. Remove drawer from compactator. See step 4 from Installation Instructions.
2. Remove the two screws that attach the handle to the drawer.
3. Remove the spacer panels and color panels. Be careful not to scratch color panels.
4. Select the color panel you wish to show and push that panel into the drawer trim.
5. Replace the spacer panels and other color panels.

### ⚠ WARNING

**Personal Injury Hazard**  
Replace handle before operating compactator. Failure to do so could result in personal injury.

6. Reattach the handle using the two screws removed in step 2 above.
7. Replace drawer as explained in step 12 of the Installation Instructions.

## Custom-made panels

A custom-made, 1/4"- thick(6cm) panel cut to the dimensions shown below, can be used in place of the color panels. Decorative materials such as wallpaper can also be applied to color panel.

1. Follow steps 1 through 3 from Changing color panel.
2. Slide decorative panel between trim pieces.
3. Reattach drawer handle.
4. Replace drawer into compactor cabinet.

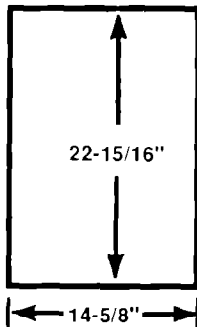

## If your compactor is not operating properly...

### Check the following before calling for service:

- Is the power supply cord securely plugged into the electrical outlet?
- Has a fuse blown or circuit breaker tripped?
- Is the drawer completely closed?
- Is the key knob turned completely to the "START" position before it is released?

## If trash is not compacted...

### Check the following:

- If the compactor stops during compaction, push drawer in while turning key knob to start. Rearrange trash load. Avoid putting rigid items at the front of drawer.
- Drawer must be at least one-third full to see compaction.
- Load only a few trash items; then use the compacting cycle. Use the compacting cycle frequently.
- Bottles do not always break. Whether bottles break depends on the trash load.

## If drawer will not open...

Check that compacting ram is all the way to the top. Push drawer in firmly. Turn key knob to "START" and release key knob. Open drawer and rearrange trash load. Start compactor again.