



USER'S GUIDE

Coil Electric Range

Table of Contents

Safety 1-3

Care & Cleaning 4-6

Self-Clean Oven
Cleaning Procedures

Maintenance 7-8

Oven Window
Oven Light

Troubleshooting 8-9

Surface Cooking 10-11

Controls
Coil Elements

Oven Cooking 11-18

Manual Clean Oven Control

Clock Baking
Timer Broiling

Manual Clean Oven Knob Control

Baking Broiling

Self-Clean Oven Control

Clock Delay Bake
Timer Keep Warm
Baking Broiling
Cook & Hold Oven Racks

Warranty & Service 19

Installer: Please leave this guide with this appliance.

Consumer: Please read and keep this guide for future reference. Keep sales receipt and/or canceled check as proof of purchase.

Model Number _____

Serial Number _____

Date of Purchase _____

If you have questions, call:

Customer Assistance
1-800-688-9900 USA
1-800-688-2002 Canada
1-800-688-2080 (U.S. TTY for
hearing or speech impaired)
(Mon.-Fri., 8 am-8 pm Eastern Time)

In our continuing effort to improve the quality and performance of our cooking products, it may be necessary to make changes to the appliance without revising this guide.

For service information, see page 19.

To ensure proper and safe operation: Appliance must be properly installed and grounded by a qualified technician.

Do not attempt to adjust, repair, service, or replace any part of your appliance unless it is specifically recommended in this guide. All other servicing should be referred to a qualified servicer.

Always disconnect power to appliance *before* servicing.

WARNING

- **ALL RANGES CAN TIP AND CAUSE INJURIES TO PERSONS**
- **INSTALL ANTI-TIP DEVICE PACKED WITH RANGE**
- **FOLLOW ALL INSTALLATION INSTRUCTIONS**



WARNING: To reduce risk of tipping of the appliance from abnormal usage or by excessive loading of the oven door, the appliance must be secured by a properly installed anti-tip device.

Important Safety Instructions

Warning and Important Safety Instructions appearing in this guide are not meant to cover all possible conditions and situations that may occur. Common sense, caution, and care must be exercised when installing, maintaining, or operating the appliance.

Always contact the manufacturer about problems or conditions you do not understand.

Recognize Safety Symbols, Words, Labels

WARNING

WARNING – Hazards or unsafe practices which **COULD** result in severe personal injury or death.

CAUTION

CAUTION – Hazards or unsafe practices which **COULD** result in minor personal injury.

Read and follow all instructions *before* using this appliance to prevent the potential risk of fire, electric shock, personal injury or damage to the appliance as a result of improper usage of the appliance. Use appliance only for its intended purpose as described in this guide.

To check if device is properly installed, look underneath range with a flashlight to make sure one of the rear leveling legs is properly engaged in the bracket slot. The anti-tip device secures the rear leveling leg to the floor when properly engaged. You should check this **anytime** the range has been moved.

To Prevent Fire or Smoke Damage

Be sure all packing materials are removed from the appliance *before* operating it.

Keep area around appliance clear and free from combustible materials. Flammable materials **should not** be stored in an oven.

Many plastics are vulnerable to heat. Keep plastics away from parts of the appliance that may become warm or hot.

To prevent grease fires, **do not** let cooking grease or other flammable materials accumulate in or near the appliance.

In Case of Fire

Use dry chemical or foam-type extinguisher or baking soda to smother fire or flame. **Never** use water on a grease fire.

1. Turn off appliance to avoid spreading the flame.
2. **NEVER** pick up or move a flaming pan.
3. Smother oven fire or flame by closing the oven door.

Child Safety

CAUTION

NEVER store items of interest to children in cabinets above an appliance. Children climbing on the appliance or on the appliance door to reach items could be seriously injured.

NEVER leave children alone or unsupervised near the appliance when it is in use or is still hot. Children **should never** be allowed to sit or stand on any part of the appliance as they could be injured or burned.

Children must be taught that the appliance and utensils in it can be hot. Let hot utensils cool in a safe place, out of reach of small children. Children should be taught that an appliance is not a toy. Children **should not** be allowed to play with controls or other parts of the appliance.

About Your Appliance

CAUTION

NEVER use an appliance as a step to reach cabinets above. Misuse of appliance door, such as stepping, leaning or sitting on the door, may result in possible tipping of the appliance, breakage of door, and serious injuries.

To prevent potential hazard to the user and damage to the appliance, **do not** use appliance as a space heater to heat or warm a room. Also, **do not** use the oven as a storage area for food or cooking utensils.

Do not obstruct the flow of air by blocking the oven vent.

DO NOT TOUCH HEATING ELEMENTS OR INTERIOR SURFACES OF OVEN. Heating elements may be hot even though they are dark in color. Interior surfaces of any oven become hot enough to cause burns. During and after use, **do not** touch, or let clothing or other flammable materials contact heating elements or interior surfaces of oven until they have had sufficient time to cool. Other surfaces of the appliance may become hot enough to cause burns – among these surfaces are: oven vent opening, surface near this opening, oven door and window of oven door.

Do not touch a hot oven light bulb with a damp cloth as the bulb could break. Should the bulb break, disconnect power to the appliance **before** removing bulb to avoid electrical shock.

NEVER use aluminum foil to cover an oven rack or oven bottom. Misuse could result in risk of electric shock, fire, or damage to the appliance. Use foil only as directed in this guide.

Cooking Safety

Never heat an unopened food container in the oven. Pressure build-up may cause container to burst resulting in serious personal injury or damage to the appliance.

Use dry, sturdy potholders. Damp potholders may cause burns from steam. Dish towels or other substitutes **should never** be used as potholders because they can trail across hot elements and ignite or get caught on appliance parts.

Wear proper apparel. Loose fitting or long hanging-sleeved apparel should not be worn while cooking. Clothing may ignite and cause burns if garment comes in contact with heating elements.

Always place oven racks in the desired positions while oven is cool. Slide oven rack out to add or remove food, using dry, sturdy potholders. Always avoid reaching into the oven to add or remove food. If a rack must be moved while hot, use a dry potholder. **Do not** let potholder contact hot element in oven.

Use racks only in the oven in which they were shipped/purchased.

Use care when opening the oven door. Let hot air or steam escape before removing or replacing food.

PREPARED FOOD WARNING: Follow food manufacturer's instructions. If a plastic frozen food container and/or its cover distorts, warps, or is otherwise damaged during cooking, immediately discard the food and its container. The food could be contaminated.

Do not allow aluminum foil or meat probe to contact heating element.

Always turn off all controls when cooking is completed.

Utensil Safety

Follow the manufacturer's directions when using oven cooking bags.

This appliance has been tested for safe performance using conventional cookware. **Do not** use any devices or accessories that are not specifically recommended in this guide. **Do not** use element covers, stove top grills or add-on oven convection systems. The use of devices or accessories that are not expressly recommended in this guide can create serious safety hazards, result in performance problems, and reduce the life of the components of the appliance.

If pan is smaller than element, a portion of the element will be exposed to direct contact and could ignite clothing or potholder.

Only certain types of glass, glass/ceramic, ceramic, earthenware, or other glazed utensils are suitable for cooktop or oven service without breaking due to the sudden change in temperature. Follow utensil manufacturer's instructions when using glass.

Turn pan handle toward center of cooktop, not out into the room or over another surface element. This reduces the risk of burns, ignition of flammable materials, or spillage if pan is accidentally bumped or reached by small children.

Be sure utensil is large enough to properly contain food and avoid boilovers. Pan size is particularly important in deep fat frying. Be sure pan will accommodate the volume of food that is to be added as well as the bubble action of fat.

Never let a pan boil dry as this could damage the utensil and the appliance.

Cooktop

NEVER leave surface units unattended, especially when using high heat. An unattended boilover could cause smoking and a greasy spillover can cause a fire.

This appliance is equipped with different sized surface elements. Select pans with flat bottoms large enough to cover element. Fitting pan size to element will improve cooking efficiency.

Coil Elements

To prevent damage to removable heating elements, **do not** immerse, soak or clean in a dishwasher or self-clean oven. A damaged element could short resulting in a fire or shock hazard.

Make sure drip bowls are in place as absence of these bowls during cooking could damage wiring.

Protective Liners: Do not use aluminum foil to line surface unit drip bowls or oven bottoms, except as suggested in the manual. Improper installation of these liners may result in a risk of electric shock or fire.

Deep Fat Fryers

Use extreme caution when moving the grease pan or disposing of hot grease. Allow grease to cool *before* attempting to move pan.

Ventilating Hoods

Clean range hood and filters frequently to prevent grease or other flammable materials from accumulating on hood or filter and to avoid grease fires.

When flaming foods under the hood, turn the fan on.

Cleaning Safety

Clean cooktop with caution. Turn off all controls and wait for appliance parts to cool *before* touching or cleaning. Clean with caution. Use care to avoid steam burns if a wet sponge or cloth is used to wipe spills on a hot surface. Some cleaners can produce noxious fumes if applied to a hot surface.

Clean only parts listed in this guide.

Self-Clean Oven (select models)

CAUTION

Before self-cleaning the oven, remove the oven racks, broiler pan, food and any other utensils. Wipe spillovers to prevent excessive smoke and flare-ups.

Do not clean door gasket. The door gasket is essential for a good seal. Care should be taken not to rub, damage, or move the gasket.

Do not use oven cleaners or oven liners of any kind in or around any part of the self-clean oven.

It is normal for the cooktop of the range to become hot during a self-clean cycle. Therefore, touching the cooktop during a clean cycle should be avoided.

Important Safety Notice and Warning

The California Safe Drinking Water and Toxic Enforcement Act of 1986 (Proposition 65) requires the Governor of California to publish a list of substances known to the State of California to cause cancer or reproductive harm, and requires businesses to warn customers of potential exposures to such substances.

Users of this appliance are hereby warned that when the oven is engaged in the self-clean cycle, there may be some low-level exposure to some of the listed substances, including carbon monoxide. Exposure to these substances can be minimized by properly venting the oven to the outdoors by opening the windows and/or door in the room where the appliance is located during the self-clean cycle.

IMPORTANT NOTICE REGARDING PET BIRDS: Never keep pet birds in the kitchen or in rooms where the fumes from the kitchen could reach. Birds have a very sensitive respiratory system. Fumes released during an oven self-cleaning cycle may be harmful or fatal to birds. Fumes released due to overheated cooking oil, fat, margarine and overheated non-stick cookware may be equally harmful.

Save These Instructions for Future Reference

Care & Cleaning

Self-Clean Oven (select models)

Important: For manual clean oven, see page 6.

⚠ CAUTION

- It is normal for parts of the range to become hot during a self-clean cycle.
- To prevent personal injury and damage to the oven door **do not** attempt to open door when “LOCK” is displayed.
- Avoid touching cooktop, door, window or oven vent area during a clean cycle.
- **Do not** use commercial oven cleaners on the oven finish or around any part of the oven. They will damage the finish or parts.

The self-clean cycle uses above-normal cooking temperatures to automatically clean the oven interior. **Do not** force the oven door or lock lever open. This may result in exposure to high temperatures and be a burn hazard.

The oven should be cleaned regularly by wiping up spillovers to prevent excessive smoke and flare-ups. **Do not** allow a heavy build-up of soil to accumulate in the oven.

During the cleaning process, the kitchen should be well ventilated to get rid of normal odors associated with cleaning.

Before Self-Cleaning

1. Turn off the oven light *before* cleaning. The light may burn out during the clean cycle.
2. Remove broiler pan, all pans, and oven racks from the oven. The oven racks will discolor and may not slide easily after a self-clean cycle if they are not removed.
3. Clean oven frame, door frame, area outside of gasket, and around the opening in the door gasket with a nonabrasive cleaner such as Bon Ami* or detergent and water. The self-cleaning process does not clean these areas. They should be cleaned to prevent soil from baking on during the clean cycle. (The gasket is the seal around the oven door and window).
4. To prevent damage, **do not** clean or rub the gasket around the oven door. The gasket is designed to seal in heat during the clean cycle.
5. Wipe up excess grease or spillovers from the oven bottom. This prevents excessive smoking, flare-ups or flaming during the clean cycle.

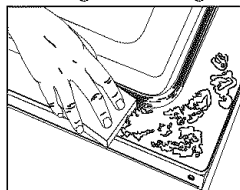

6. Wipe up sugary and acidic spillovers such as sweet potatoes, tomato, or milk-based sauces. Porcelain enamel is acid-resistant, not acid-proof. The porcelain finish may discolor if acidic spills are not wiped up before a self-clean cycle.

To set Self-Clean:

Important: Oven temperature must be below 400° F to program a clean cycle.

1. Close the oven door.
2. Move door lock lever *right* to the locked position.



3. Press the **CLEAN** pad.



- “CLEAN” flashes in the display.

If the door is not closed, beeps will sound and “DOOR” will display. If the door is not closed within 45 seconds, the self-cleaning operation will be canceled and the display will return to the time of day.

4. Press the ▲ or ▼ pad.

- “CL-M” (Medium Soil, 3 hours) is displayed.



5. Press the ▲ or ▼ pad to scroll through the self-cleaning settings.

“CL-H” (Heavy Soil, 4 hours)

“CL-M” (Medium Soil, 3 hours)

“CL-L” (Light Soil, 2 hours)

Choosing the soil level of the oven automatically programs the self-cleaning time.

6. After four seconds, the oven will start cleaning.

- The cleaning time will start counting down in the display.
- “LOCK” will appear in the display.
- “CLEAN” will appear in the display.

To Delay a Self-Clean Cycle:

1. Press the **DELAY** pad.



- “DELAY” flashes.
- 00:00 will appear in the display.



2. Press the ▲ or ▼ pad to set the amount of time you want to delay the cycle. Delay time can be set from ten minutes (00:10) to 11 hours, 59 minutes (11:59).

Cont.

* Brand names for cleaning products are registered trademarks of the respective manufacturers.

- Press the **CLEAN** pad.
 - “CLEAN” will flash.
- Press the ▲ or ▼ pad.
 - “CL-M” (Medium Soil, 3 hours) is displayed.

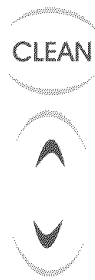

CL-H” (Heavy Soil, 4 hours)
 CL-M” (Medium soil, 3 hours)
 CL-L” (Light Soil, 2 hours)

Choosing the soil level of the oven automatically programs the self-cleaning time.

- After four seconds, CLEAN, DELAY and LOCK will appear in the display to show that the oven is set for a delayed clean operation. The delay time is displayed.



If the oven has already been set for a clean cycle and you wish to set a delay:

- Press the **DELAY** pad.
 - “DELAY” flashes.
 - 00:00 will appear in the display.
- Press the ▲ or ▼ pad to set the amount of time you want to delay the cycle.



After four seconds, CLEAN, DELAY and LOCK will appear in the display to show that the oven is set for a delayed clean operation. The delay time is displayed.

When the Self-Clean cycle starts:

- “DELAY” will turn off.
- The clean time will appear in the display.

To cancel the Self-Clean cycle:

Press the **CANCEL** pad.

- All words disappear from the display.
- All functions are canceled.
- The time of day appears in the display.



During the Self-Clean Cycle

When LOCK shows in the display, the door cannot be opened. To prevent damage to the door, **do not** force the door open when LOCK is displayed.

Smoke and Smells

You may see some smoke and smell an odor the first few times the oven is cleaned. This is normal and will lessen in time.

Smoke may also occur if the oven is heavily soiled or if a broiler pan was left in the oven.

Sounds

As the oven heats, you may hear sounds of metal parts expanding and contracting. This is normal and will not damage the oven.

After Self-Cleaning

About one hour after the end of the self-clean cycle, “LOCK” will turn off. The door can then be opened. The door can then be opened. Move door lock lever to the *left* to unlock.

Some soil may leave a light gray, powdery ash. Remove it with a damp cloth. If soil remains after wiping, that means the clean cycle was not long enough. The soil will be removed during the next clean cycle.

If oven racks were left in the oven and do not slide smoothly after a clean cycle, wipe racks and rack supports with a small amount of vegetable oil to make them easier to move.

Fine lines may appear in the porcelain because it went through heating and cooling. This is normal and will not affect performance.

A white discoloration may appear after cleaning if acidic or sugary foods were not wiped up before the self-clean cycle. This discoloration is normal and will not affect performance.

Notes:

- If the oven door is left open, “DOOR” will flash in the display and a signal will beep until the door is closed and the CLEAN pad is pressed again.
- The oven door will be damaged if the oven door is forced to open when “LOCK” is still displayed.

Cleaning Procedures

! CAUTION

- **Be sure appliance is off and all parts are cool before handling or cleaning. This is to avoid damage and possible burns.**
- To prevent staining or discoloration, clean appliance after each use.
- If a part is removed, be sure it is correctly replaced.

Backguard and Cooktop – Porcelain Enamel

Porcelain enamel is glass fused on metal and may crack or chip with misuse. It is acid-resistant, not acid-proof. All spillovers, especially acidic or sugary spillovers, should be wiped up immediately with a dry cloth.

- When cool, wash with soapy water, rinse and dry.
- **Never** wipe off a warm or hot surface with a damp cloth. This may cause cracking or chipping.
- **Never** use oven cleaners, abrasive or caustic cleaning agents on exterior finish of range.

Broiler Pan and Insert

Never cover insert with aluminum foil as this prevents the fat from draining to the pan below.

- Place soapy cloth over insert and pan; let soak to loosen soil.
- Wash in warm, soapy water. Use scouring pad to remove stubborn soil.
- Broiler pan and insert can be cleaned in dishwasher.

Clock and Control Pad Area

- To activate "Control Lock" for cleaning, see page 14.
- Wipe with a damp cloth and dry. **Do not** use abrasive cleaning agents as they may scratch the finish.
- Glass cleaners may be used if sprayed on a cloth first. **DO NOT spray directly on control pad and display area.**

Control Knobs

- Remove knobs in the OFF position by pulling forward.
- Wash, rinse and dry. **Do not** use abrasive cleaning agents as they may scratch the finish.
- Turn on each element to be sure the knobs have been correctly replaced.

Drip Bowls – Porcelain (select models)

Porcelain may discolor or craze if overheated. This is normal and will not affect cooking performance.

- When cool, wash after each use, rinse and dry to prevent staining or discoloration. May be washed in the dishwasher.
- To clean heavy soil, soak in hot sudsy water, then use a mild abrasive cleaner such as Soft Scrub* and a plastic scouring pad.
- For burned on soil, remove from range, place on newspapers and carefully spray with commercial oven cleaner. (**Do not** spray surrounding surfaces.) Place in plastic bag and allow to soak several hours. Wearing rubber gloves, remove from bag, wash, rinse and dry.

Drip Bowls – Chrome/Painted Enamel (select models)

- When cool, wash after each use, rinse and dry to prevent staining or discoloration.
- To clean heavy soil, soak in hot sudsy water, then use a mild abrasive cleaner such as Soft Scrub* and a plastic scouring pad. **Do not** use abrasive cleaning agents.

Oven Window and Door – Glass (select models)

- Avoid using excessive amounts of water which may seep under or behind glass, causing staining.
- Wash with soap and water. Rinse with clear water and dry. Glass cleaner can be used if sprayed on a cloth first.
- **Do not** use abrasive materials such as scouring pads, steel wool or powdered cleaners as they will scratch glass.

Oven Interior

Self-Clean:

- Follow instructions on page 4-5 to set a self-clean cycle.

* Brand names are registered trademarks of the respective manufacturers.

** To order call 1-877-232-6771 USA or 1-800-688-8408 Canada.

Manual Clean:

- Clean frequently using mild abrasive cleaners and a plastic pad.
- **Do not** use metallic scouring pads because they will scratch the surface.
- When using commercial oven cleaners follow the manufacturer's instructions.
- Wipe up acidic spills (tomato or milk based foods) as soon as possible with soap and water. If the spill is not wiped up, it may discolor the porcelain.

To make cleaning easier, remove the oven door, if desired. (See *Maintenance* section on page 7.)

Oven Racks

- Clean with soapy water.
- Remove stubborn soil with cleansing powder or soap-filled scouring pad. Rinse and dry.
- Racks will permanently discolor and may not slide smoothly if left in the oven during a self-clean operation. If this occurs, wipe the rack edge and rack support with a small amount of vegetable oil to restore ease of movement, then wipe off excess oil.

Stainless Steel (select models)

- **DO NOT USE ANY CLEANING PRODUCT CONTAINING CHLORINE BLEACH.**
- **DO NOT USE ABRASIVE OR ORANGE CLEANERS.**
- **ALWAYS WIPE WITH THE GRAIN WHEN CLEANING.**
- **Daily Cleaning/Light Soil** -- Wipe with one of the following - soapy water, white vinegar/water solution, Formula 409 Glass and Surface Cleaner* or a similar glass cleaner - using a sponge or soft cloth. Rinse and dry. To polish and help prevent fingerprints, follow with Stainless Steel Magic Spray (Part No. 20000008)**.
- **Moderate/Heavy Soil** -- Wipe with one of the following - Bon Ami, Smart Cleanser, or Soft Scrub* - using a damp sponge or soft cloth. Rinse and dry. Stubborn soils may be removed with a damp multi-purpose Scotch-Brite* pad; rub evenly with the grain. Rinse and dry. To restore luster and remove streaks, follow with Stainless Steel Magic Spray*.
- **Discoloration** -- Using a damp sponge or soft cloth, wipe with Cameo Stainless Steel Cleaner*. Rinse immediately and dry. To remove streaks and restore luster, follow with Stainless Steel Magic Spray*.

Oven Door (select models), Storage Drawer, Door Handle, Side Panels – Painted Enamel

- When cool, wash with warm soapy water, rinse and dry. **Never** wipe a warm or hot surface with a damp cloth as this may damage the surface and may cause a steam burn.
- For stubborn soil, use mildly abrasive cleaning agents such as baking soda paste or Bon Ami.* **Do not** use abrasive, caustic or harsh cleaning agents such as steel wool pads or oven cleaners. These products will scratch or permanently damage the surface.

Important: Use a dry towel or cloth to wipe up spills, especially acidic or sugary spills. Surface may discolor or dull if soil is not immediately removed. This is especially important for white surfaces.

Maintenance

Oven Door

! CAUTION

- **Do not** place excessive weight on or stand on an open oven door. This could cause the range to tip over, break the door, or injure the user.
- **Do not** attempt to open or close door or operate oven until door is properly replaced.
- **Never** place fingers between hinge and front oven frame. Hinge arms are spring mounted. If accidentally hit, the hinge will slam shut against oven frame and could injure your fingers.

To remove:

1. When cool, open the oven door to the first stop position (opened about four inches).
2. Grasp door at each side. **Do not** use the door handle to lift door.
3. Lift up evenly until door clears hinge arms.

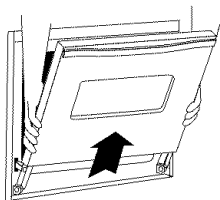

To replace:

1. Grasp door at each side.
2. Align slots in the door with the hinge arms on the range.
3. Slide the door down onto the hinge arms until the door is completely seated on the hinges. Push down on the top corners of the door to completely seat door on hinges. Door should not appear crooked.

Important: The oven door on a new range may feel “spongy” when it is closed. This is normal and will decrease with use.

Oven Window (select models)

To protect the oven door window:

1. **Do not** use abrasive cleaning agents such as steel wool scouring pads or powdered cleansers as they may scratch the glass.
2. **Do not** hit the glass with pots, pans, furniture, toys, or other objects.
3. **Do not** close the oven door until the oven racks are in place.

Scratching, hitting, jarring or stressing the glass may weaken its structure causing an increased risk of breakage at a later date.

Oven Light

! CAUTION

- Disconnect power to range *before* replacing light bulb.
- Use a dry potholder to prevent possible harm to hands when replacing bulb.
- Be sure bulb is cool *before* touching bulb.
- **Do not** touch hot bulb with a damp cloth as this may cause the bulb to break.

To Replace Oven Light Bulb:

1. When oven is cool, hold bulb cover in place, then slide wire retainer off cover.

Important: Bulb cover will fall if not held in place while removing wire retainer.

2. Remove bulb cover and light bulb.
3. Replace with a 40-watt appliance bulb.
4. Replace bulb cover and secure with wire retainer.
5. Reconnect power to range. Reset clock.

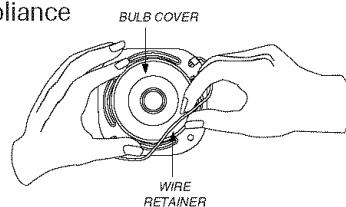

Leveling Legs

! CAUTION

Be sure the anti-tip bracket secures one of the rear leveling legs to the floor. This bracket prevents the range from accidentally tipping.

Be sure the range is leveled when installed. If the range is not level, turn the leveling legs, located at each corner of the range, until range is level.

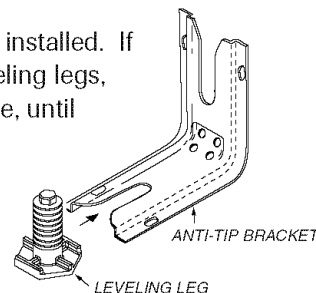

Storage Drawer

CAUTION

Do not store plastic, paper products, food or flammable materials in this drawer. The drawer may become too warm for these items when the oven is in use.

The storage drawer can be removed to allow you to clean under the range.

To remove:

1. Empty drawer and pull out to the first stop position.
2. Lift up the front of the drawer.
3. Pull out to the second stop position.
4. Grasp sides and lift drawer top up and out.

To replace:

1. Fit the ends of the drawer glides into the rails in the range.
2. Lift up the front of the drawer and gently push in to the first stop position.
3. Lift drawer up again and push until drawer is closed.

Convenience Outlet

(Canadian models only)

The convenience outlet is located on the lower left side of the backguard. Be sure appliance cords do not rest on or near the surface element. If the surface element is turned on, the cord and outlet will be damaged.

The convenience outlet circuit breaker may trip if the small appliance plugged into it exceeds 10 amps. To reset the circuit breaker, press the switch located on the lower edge of the backguard.

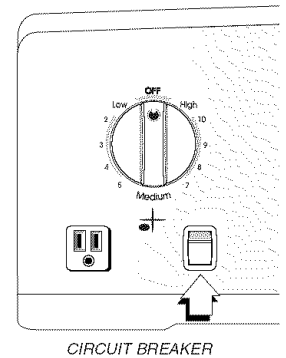

Troubleshooting

For most concerns, try these first.

- Check if oven controls have been properly set.
- Check to be sure plug is securely inserted into receptacle.
- Check or re-set circuit breaker. Check or replace fuse.
- Check power supply.

Part or all of appliance does not work.

- Check if surface and/or oven controls have been properly set. See pages 10-14.
- Check if oven door is unlocked after self-clean cycle. See page 5.
- Check if oven is set for a delayed cook or clean program. See pages 15 & 5.
- Check if Control Lock is activated. See page 14.
- Check if control is in Sabbath Mode. See page 17.

Clock, indicator words, and/or lights operate but oven does not heat.

- Oven may be set for a Cook & Hold or delay function.
- The Control Lock may have been set. See page 14.

Baking results are not as expected or differ from previous oven.

- Make sure the oven vent has not been blocked. See page 18 for location.
- Check to make sure range is level.

- Temperatures often vary between a new oven and an old one. As ovens age, the oven temperature often “drifts” and may become hotter or cooler. See page 17 for instructions on adjusting the oven temperature (select models).

Important: It is not recommended to adjust the temperature if only one or two recipes are in question.

Food is not broiling properly or smokes excessively.

- Check oven rack positions. Food may be too close to element.
- Broil element was not preheated.
- Aluminum foil was incorrectly used. Never line the broiler insert with foil.
- Oven door was closed during broiling. Leave the door open to the first stop position (about 4 inches).
- Trim excess fat from meat *before* broiling.
- A soiled broiler pan was used.
- Voltage in house may be low.

Oven will not self-clean (select models).

- Check to make sure the cycle is not set for a delayed start. See page 5.
- Check if door is closed.
- Check if control is in Sabbath Mode. See page 17.
- Oven may be over 400° F. Oven temperature must be below 400° F to program a clean cycle.

Oven did not clean properly (select models).

- Longer cleaning time may be needed.
- Excessive spillovers, especially sugary and/or acidic foods, were not removed prior to the self-clean cycle.

Oven door will not unlock after self-clean cycle (select models).

- Oven interior is still hot. Allow about one hour for the oven to cool after the completion of a self-clean cycle. The door can be opened when the LOCK is not displayed.
- The control and door may be locked. See page 14.

Moisture collects on oven window or steam comes from oven vent.

- This is normal when cooking foods high in moisture.
- Excessive moisture was used when cleaning the window.

There is a strong odor or light smoke when oven is turned on.

- This is normal for a new range and will disappear after a few uses. Initiating a clean cycle will “burn off” the odors more quickly.
- Turning on a ventilation fan will help remove the smoke and/or odor.
- Excessive food soils on the oven bottom. Use a self-clean cycle (select models).

Fault Codes (select models)

- BAKE or LOCK may flash rapidly in the display to alert you if there is an error or a problem. If BAKE or LOCK appear in the display, press **CANCEL** pad. If BAKE or LOCK continue to flash, disconnect power to the appliance. Wait a few minutes, and then reconnect power. If the flashing still continues, disconnect power to the appliance and call an authorized servicer.
- If the oven is heavily soiled, excessive flareups may result in a fault code during cleaning. Press the **CANCEL** pad and allow the oven to cool completely, wipe out excess soil, then reset the clean cycle. If the fault code reappears, contact an authorized servicer.

Noises may be heard.

- The oven makes several low level noises. You may hear the oven relays as they go on and off. This is normal.
- As the oven heats and cools, you may hear sounds of metal parts expanding and contracting. This is normal and will not damage your appliance.

There are no beeps and no display.

- Control may be in Sabbath Mode (select models). See page 17.

“SAb” flashing and then displayed continuously.

- Oven is in Sabbath Mode. To cancel, press and hold the **CLOCK** pad for five seconds.

Surface Cooking

Surface Controls

Use to turn on the surface elements. An infinite choice of heat settings is available from Low to High. The knobs can be set on or between any of the settings.

Setting the Controls

1. Place pan on surface element.
2. Push in and turn the knob in either direction to the desired heat setting.
 - The control panel is marked to identify which element the knob controls. For example, the graphic at right indicates left front element.
3. There is an element "ON" indicator light on the control panel. When any surface control knob is turned on, the light will turn on. The light will turn off when all the surface elements are turned off.
4. After cooking, turn knob to **OFF**. Remove pan.



Suggested Heat Settings

The size, type of cookware and cooking operation will affect the heat setting.

Low (2): Food maintains a temperature above 140° F without continuing to cook. Food is heated on a higher setting until it reaches this temperature.

Med. Low (3-4): Use to continue cooking covered foods or steam foods.

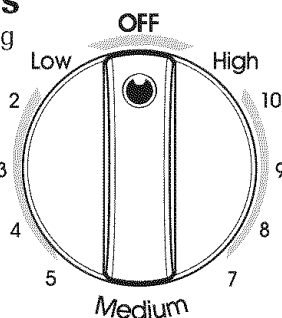

(Style varies by model)

Medium (5-7): Use to maintain slow boil for large amounts of liquids and for most frying operations.

Med. High (8-9): Use to brown meat, heat oil for deep fat frying or sauteing. Maintain fast boil for large amounts of liquids.

High (10): Use to bring liquid to a boil. Always reduce setting to a lower heat when liquids begin to boil or foods begin to cook.

Coil Element Surface

Notes:

- Clean cooktop after each use.
- Wipe acidic or sugary spills as soon as the cooktop has cooled as these spills may discolor or etch the porcelain.

To protect drip bowl finish:

- To lessen discoloration and crazing, avoid using high heat for long periods.
- **Do not** use oversized cookware. Pans **should not** extend more than 1-2 inches beyond the element.
- When home canning or cooking with big pots, use the Canning Element (Model CE1). Contact your dealer for details or call 1-877-232-6771 USA or 1-800-688-8408 Canada to order.
- Clean frequently. (See page 6.)

! CAUTION

BEFORE COOKING

- Always place a pan on the surface unit *before* you turn it on. To prevent damage to range, **never** operate surface unit without a pan in place.
- **NEVER** use the cooktop as a storage area for food or cookware.

DURING COOKING

- Be sure you know which knob controls which surface unit. Make sure you turned on the correct surface unit.
- Begin cooking on a higher heat setting then reduce to a lower setting to complete the operation. **Never** use a high heat setting for extended cooking.
- **NEVER** allow a pan to boil dry. This could damage the pan and the appliance.
- **NEVER** touch cooktop until it has cooled. Expect some parts of the cooktop, especially around the surface units, to become warm or hot during cooking. Use potholders to protect hands.

AFTER COOKING

- Make sure surface unit is turned off.
- Clean up messy spills as soon as possible.

OTHER TIPS

- If cabinet storage is provided directly above cooking surface, limit it to items that are infrequently used and can be safely stored in an area subjected to heat. Temperatures may be unsafe for items such as volatile liquids, cleaners or aerosol sprays.
- **NEVER** leave any items, especially plastic items, on the cooktop. The hot air from the vent may ignite flammable items, melt or soften plastics, or increase pressure in closed containers causing them to burst.
- **NEVER** allow aluminum foil, meat probes or any other metal object, other than a pan on a surface element, to contact heating elements.

Coil Elements

- When an element is on, it will cycle on and off to maintain the heat setting.
- Coil elements are self-cleaning. **Do not** immerse in water.

To remove: When cool, raise element. Carefully pull out and away from receptacle.

To replace: Insert element terminals into receptacle. Guide the element into place. Press down on the outer edge of element until it sits level on drip bowl.

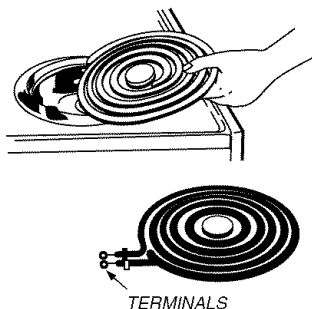

Drip Bowls

The drip bowls under each surface element catch boilovers and must always be used. Absence of drip bowls during cooking may damage wiring.

To prevent the risk of electric shock or fire, never line drip bowls with aluminum foil.

Drip bowls will discolor (blue/gold stains) or craze over time if overheated. This discoloration or crazing is permanent. This will not affect cooking performance.

Oven Cooking

Manual Clean Oven Control (select models)

BAKE	Use for baking and roasting.
BROIL	Use for broiling and top browning.
TIMER	Sets timer.
CLOCK	Use to set time-of-day clock.
CANCEL	Cancels all operations except timer and clock.
▲ or ▼	Enters or changes time, oven temperature. Sets HI or LO broil.

Using the Touchpads

- Press the desired pad.
- Press the ▲ or ▼ pad to enter time or temperature.
- A beep will sound each time a function pad is pressed. There is no beep for the ▲ or ▼ pad.
- A double beep will sound if a programming error occurs.

Important: Four seconds after pressing the ▲ or ▼ pad, the time or temperature will automatically be entered. If more than 30 seconds elapse between touching a function pad and the ▲ or ▼ pad, the function will be canceled and the display will return to the previous display.

Setting the Clock

1. Press the **CLOCK** pad.
 - The clock time cannot be set if the control is programmed for a bake, broil or timing operation.
2. Set the correct time of day using the ▲ or ▼ pads. If the ▲ or ▼ pad is not pressed within 30 seconds, the program will cancel. Press the Clock pad and begin again.

Setting the Timer

The timer can be set from one minute (:01) up to 99 hours and 59 minutes (99:59). Time will be displayed in minutes and not in seconds. **THE TIMER DOES NOT CONTROL THE OVEN.**

1. Press the **TIMER** pad.
 - 0:00 will light and the colon (:) will flash in the display.
2. Press the ▲ or ▼ pad until the desired time is displayed.
 - The timer will begin as soon as the time is set.
 - The flashing colon indicates that a timing operation is in progress. (The colon will not flash if the time of day or oven temperature is displayed.)
 - Two short beeps signal the end of the operation. "0:00" will appear in the display.
 - If desired, press the **CLOCK** pad and the time of day will briefly reappear in the display during a timing operation.
 - If desired, press the **BAKE** or **BROIL** pads and the current temperature setting will briefly reappear in the display during a timing operation.



To cancel the timer operation:

Press and hold the **TIMER** pad for several seconds.

Baking, Roasting and Broiling

Setting the Controls For Baking or Roasting:

1. Press **BAKE** pad.
 - 000 will light and the Bake indicator light will flash in the display.
 - If you press the **BAKE** pad and do not set an oven temperature within 30 seconds, the program will automatically cancel and the time of day will reappear in the display.
2. Press the ▲ or ▼ pad until the desired oven temperature is displayed.
 - The oven temperature can be set from 170° to 550° F.
 - 350° will appear in the display when either ▲ or ▼ pad is pressed once.
 - Press and tap the ▲ or ▼ pad to change the oven temperature by 5° increments or press and hold the ▲ or ▼ pad to change the oven temperature by 10° increments.
 - 100° or the actual oven temperature, whichever is higher, will appear in the display when the oven turns on.
 - The temperature in the display will increase in 5° increments until preset temperature is reached. A single beep will sound when the oven is preheated.
 - Allow 10 to 15 minutes for the oven to preheat.
 - To recall preset temperature during preheat, press the **BAKE** pad. The temperature will be displayed for three seconds.
 - *To change oven temperature during cooking*, press the **BAKE** pad, then press the ▲ or ▼ pad until the desired temperature is displayed.
 - *To change oven temperature during preheat*, press the **BAKE** pad *twice*, then press the ▲ or ▼ pad until the desired temperature is displayed.
3. Place food in the oven. Check food for doneness at the minimum cooking time.
4. At the end of cooking, press the **CANCEL** pad to turn the oven off and remove the food from the oven.
 - The oven features an automatic shut-off. If the oven is left on for 12 hours it will automatically turn off and 000 will appear in the display. Press the **CANCEL** pad and the time of day will reappear in the display.



Setting the Controls For Broiling:

For best results, use pan designed for broiling.

1. Place broiler pan on recommended rack position. (See chart on page 16.)
2. Press the **BROIL** pad.
 - "SEt" will light and the Broil indicator light will flash in the display.



3. Press the ▲ pad to select Hi (high) broil or the ▼ pad to set Lo (low) broil.
 - Select **Hi broil** for normal broiling.
 - Select **Lo broil** for low temperature broiling to avoid excessive browning of longer cooking foods like poultry.
 - If you do not select Hi or Lo Broil within 30 seconds, the program will automatically cancel and the time of day will reappear in the display.
4. Preheat broil element for three minutes. Broil with the oven door open to the first stop position (about 4 inches).
5. After broiling, press **CANCEL** to turn the oven off and remove the broiler pan from the oven. The current time of day will reappear in the display.



Oven Knob Control (select models)

Oven Temp Knob

The Oven Temp Knob is used to select and maintain the oven temperature. Always turn this knob just to the desired temperature. **Do not** turn to a higher temperature and then back.

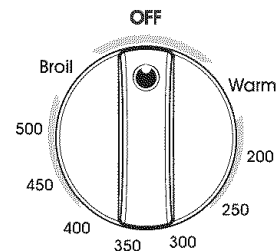

Setting the Control for Baking and Roasting:

1. Push in and turn **Oven Temp** knob to desired temperature. Allow 10-15 minutes for preheating.
2. Place food in the center of oven. Check food for doneness at minimum time in recipe. Cook longer if necessary.
3. Remove food from the oven and turn the Oven Temp knob to **OFF**.

Setting the Control for Broiling:

1. For best results, use a broiling pan. Place the broiler pan on recommended rack position (see chart on page 16).
2. Turn Oven Temp knob to **Broil** or, for lower temperature broiling, to 450° F.
 - Lower temperature broiling avoids excessive browning of longer cooking foods such as poultry.
3. Preheat broil element for *three* minutes. Broil with the oven door open to the first stop position (about 4 inches).
4. Check the doneness by cutting a slit in the meat near the center to check the color.
5. After broiling, turn the Oven Temp knob to **OFF**. Remove the broiler pan from the oven.

Self-Clean Oven Control

(select models)

BROIL	Use for broiling and top browning.
BAKE	Use for baking and roasting.
▲ or ▼ (More or Less)	Enters or changes time, oven temperature. Sets HI or LO broil.
TIMER	Sets timer.
COOK & HOLD	Bakes for a preset time, then holds food warm for 1 hour.
CLEAN	Use to set self-clean cycle.
DELAY	Programs the oven to start baking at a later time.
CLOCK	Use to set time-of-day clock.
KEEP WARM	Use to keep cooked food warm in oven.
CANCEL	Cancels all operations except timer and clock.

When electrical power is supplied or after a power interruption, the last clock time before power was interrupted will flash.

To recall the time of day when another time function is showing, press the **CLOCK** pad.

Clock time cannot be changed when the oven has been programmed for cook or clean Delay or Cook & Hold.

To cancel the Clock display:

If you do not want the time of day to display:

Press and hold the **CANCEL** and **CLOCK** pads for *three* seconds. The time of day will disappear from the display

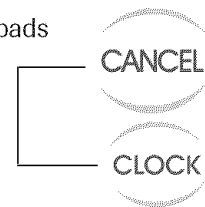

When the clock display is canceled, press the **CLOCK** pad to briefly display the time of day.

To restore the Clock display:

Press and hold the **CANCEL** and **CLOCK** pads for *three* seconds. The time of day will reappear in the display.

Using the Touchpads

- Press the desired pad.
- Press the ▲ or ▼ pad to enter time or temperature.
- A beep will sound when any pad is touched.
- A double beep will sound if a programming error occurs.

Important: Four seconds after pressing the ▲ or ▼ pad, the time or temperature will automatically be entered. If more than 30 seconds elapse between touching a function pad and the ▲ or ▼ pad, the function will be canceled and the display will return to the previous display.

Clock

The clock can be set to display time in a 12-hour or 24-hour format. The clock is set at the factory for the 12-hour format.

To change the clock to 24-hour format:

1. Press and hold the **CANCEL** and **DELAY** pads for three seconds.
2. Press the ▲ or ▼ pad to select 12 or 24 hour.
3. Set the time of day following the directions below.

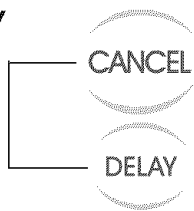

To set the Clock:

1. Press the **CLOCK** pad.
 - Time of day and the colon flash in the display.
2. Press the ▲ or ▼ pad to set the time of day.
 - Colon continues flashing.
3. Press the **CLOCK** pad again or wait four seconds.



Timer

The timer can be set from one minute (00:01) up to 99 hours and 59 minutes (99:59).

The timer can be used independently of any other oven activity. It can also be set while another oven function is operating.

The Timer does not control the oven. It only controls a beeper.

To set the Timer:

1. Press the **TIMER** pad.
 - 0:00 lights in the display.
 - The colon flashes in the display.
2. Press the ▲ or ▼ pad until the correct time appears in the display.
 - The colon will continue to flash.
3. Press **TIMER** pad again or wait four seconds.
 - The colon continues flashing and the time begins counting down.
 - The last minute of the timer countdown will be displayed as seconds.
4. At the end of the set time, one long beep will sound.



To cancel the Timer:

1. Press and hold the **TIMER** pad for *three* seconds.
OR
2. Press the **TIMER** pad and set the time to 00:00.

Locking the Controls

The touchpad controls can be locked for safety, cleaning, or to prevent unwanted use. They will not function when locked.

If the oven is currently in use, the controls cannot be locked.

The current time of day will remain in the display when the controls are locked.

To lock:

Press and hold the **CANCEL** and **COOK & HOLD** pads for *three* seconds.

- LOCK flashes in the display.

To unlock:

Press and hold the **CANCEL** and **COOK & HOLD** pads for *three* seconds.

- LOCK disappears from the display.

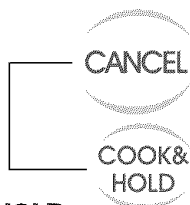

Fault Codes

BAKE or LOCK may flash rapidly in the display to alert you if there is an error or a problem. If BAKE or LOCK flash in the display, press **CANCEL** pad. If BAKE or LOCK continue to flash, disconnect power to the appliance. Wait a few minutes, and then reconnect power. If the flashing still continues, disconnect power to the appliance and call an authorized servicer.

Baking

To set Bake:

1. Press the **BAKE** pad.
 - “BAKE” will flash.
 - 000 will light in the display.
2. Select the oven temperature. The oven temperature can be set from 170° to 550°. Press or press and hold the ▲ or ▼ pads.
 - 350° will light when either pad is first pressed.
 - Press the ▲ pad to increase the temperature.
 - Press the ▼ pad to decrease the temperature.
3. Press **Bake** pad again or wait four seconds.
 - BAKE will stop flashing and light in the display.



- 100° or the actual oven temperature will display. The temperature will rise in 5° increments until the preset temperature is reached.
4. Allow the oven to preheat for 8-15 minutes.
 - When the set oven temperature is reached, one long beep will sound.
 - To recall the set temperature during preheat, press the **BAKE** pad.

5. Place food in center of oven, allowing a minimum of two inches between utensil and oven walls.
6. Check cooking progress. Cook longer if needed.
7. When cooking is finished, press **CANCEL**.
8. Remove food from the oven.



Baking Differences Between Your Old and New Oven

It is normal to notice some baking time differences between a new oven and an old one. See *Adjusting the Oven Temperature* on page 17.

Notes:

- To change oven temperature during cooking, press the **BAKE** pad, then press the ▲ or ▼ pad until the desired temperature is displayed.
- To change oven temperature during preheat, press the **BAKE** pad *twice*, then press the ▲ or ▼ pad until the desired temperature is displayed.
- If you forget to turn off the oven, it will automatically turn off at the end of 12 hours. If you wish to deactivate this feature, see page 17.

Cook & Hold

Cook & Hold allows you to bake for a preset amount of time, followed by a one-hour Keep Warm cycle.

To set Cook & Hold:

1. Press the **COOK & HOLD** pad.
 - “BAKE” and “HOLD” flash.
 - 000 lights in the display.
2. Select the oven temperature. The oven temperature can be set from 170° to 550°. Press or press and hold the ▲ or ▼ pad.
 - Press the ▲ pad to increase the temperature.
 - Press the ▼ pad to decrease the temperature.
3. Press **COOK & HOLD** again OR wait four seconds.
 - “HOLD” flashes.
 - 00:00 flashes in the display.
4. Enter the amount of time you want to bake by pressing the ▲ or ▼ pad. Bake time can be set from ten minutes (00:10) to 11 hours, 59 minutes (11:59).
 - “BAKE” and “HOLD” light in the display.
 - The baking time will light in the display.
 - The baking time will start counting down.



When the cooking time has elapsed:

- Four beeps will sound.
- “BAKE” will turn off.
- “HOLD” and “WARM” will light.
- 170° will display.



After one hour in HOLD WARM:

- “End” will display.
- The time of day reappears in the display.

To cancel Cook & Hold at any time:

Press the **CANCEL** pad. Remove food from oven.



Delay Bake



Do not use delayed baking for highly perishable foods such as dairy products, pork, poultry, or seafood.

When using Delay, the oven begins to cook later in the day. Set the amount of time that you want to delay before the oven turns on and how long you want to cook. The oven begins to heat at the selected time and cooks for the specified length of time, then keeps food warm for up to one hour.

Delay time can be set from 10 minutes (00:10) to 11 hours, 59 minutes (11:59).

To set a Delayed Baking cycle:

1. Press the **DELAY** pad.
 - “DELAY” flashes.
 - 00:00 flashes in the display.
2. Press the ▲ or ▼ pad to set the delay time.



While “DELAY” is still flashing:

3. Press the **COOK & HOLD** pad.
 - 000 lights in the display.
 - “BAKE” and “HOLD” flash.
4. Press ▲ pad to set the baking temperature.
 - 00:00 and “HOLD” flash.
 - “BAKE” stays lit.
5. Press ▲ pad to set the baking time.
 - The Delay time, “DELAY”, “BAKE” and “HOLD” light in the display.



When the Delay time has expired:

- “DELAY” will turn off.
- Baking time is displayed.
- “BAKE” and “HOLD” are displayed.

To set a Delay when Cook & Hold has already been programmed:

1. Press the **DELAY** pad.
 - “DELAY” flashes.
 - 00:00 appears in the display.
2. Press the ▲ or ▼ pad to set the delay time.
 - After four seconds, “DELAY” will stay lit to remind you that a delayed cooking cycle has been set.



When the Delay time has expired and the oven starts:

- The baking time will be displayed.
- “DELAY” will turn off.
- “BAKE” and “HOLD” will remain lit.

To cancel:

Press the **CANCEL** pad.



- All timed and untimed cooking functions will be canceled.
- The time of day will reappear in the display.

Important:

- **Do not** use delayed baking for items that require a preheated oven, such as cakes, cookies, and breads.
- **Do not** use delayed baking if oven is already hot.

Keep Warm

For safely keeping foods warm or for warming breads and plates.

To set Keep Warm:

1. Press the **KEEP WARM** pad.
 - “WARM” flashes.
 - 000 appears in the display.
 2. Select the Keep Warm temperature. The Keep Warm temperature can be set from 145° to 190°. Press or press and hold the ▲ or ▼ pad.
 - 170° will light when either pad is first pressed.
 - Press the ▲ pad to increase the temperature.
 - Press the ▼ pad to decrease the temperature.
- “WARM” and the temperature will be displayed while Keep Warm is active.



To cancel Keep Warm:

1. Press the **CANCEL** pad.
2. Remove food from the oven.



Notes:

- For optimal food quality, oven cooked foods should be kept warm for no longer than 1 to 2 hours.
- To keep foods from drying, cover loosely with foil or a lid.
- **To warm dinner rolls:**
 - cover rolls loosely with foil and place in oven.
 - press **KEEP WARM** and ▲ pads to set 170° F.
 - warm for 12-15 minutes.
- **To warm plates:**
 - place 2 stacks of up to four plates each in the oven.
 - press **KEEP WARM** and ▲ pads to set 170° F.
 - warm for five minutes, turn off the oven and leave plates in the oven for 15 minutes more.
 - use only oven-safe plates, check with the manufacturer.
 - **do not** set warm dishes on a cold surface as rapid temperature changes could cause crazing or breakage.

- Select **HI broil** (550° F) for normal broiling. Select **LO broil** (450° F) for low-temperature broiling of longer cooking foods such as poultry.

3. After four seconds, the oven will start.

- “BROIL” will remain lit.

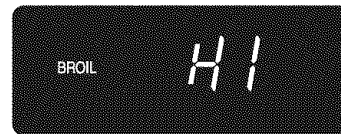

4. For optimum browning, preheat broil element for 3-4 minutes *before* adding food.
5. Place food in the oven. Leave oven door open about four inches (the first stop).
6. Turn meat once about halfway through cooking.
7. When food is cooked, press the **CANCEL** pad. Remove food and broiler pan from the oven.
 - The time of day will reappear in the display.



Broiling

To set Broil:

1. Press the **BROIL** pad.
 - “BROIL” flashes.
 - SET is displayed.
2. Press the ▲ pad to set HI broil or press the ▼ pad to set LO broil.
 - HI or LO will be displayed.



Notes:

- For best results when broiling, use a pan designed for broiling.
- Expect broil times to increase and browning to be slightly lighter if appliance is installed on a 208-volt circuit.
- HI is used for most broiling. Use LO broil when broiling longer cooking foods. The lower temperature allows food to cook to the well done stage without excessive browning.
- Broil times may be longer when the lower broiling temperature is selected.

Broiling Chart

FOODS	RACK POSITION*	DONENESS	TOTAL COOK TIME
Beef			
Steak, 1” thick	4	Medium	15 - 18 minutes
	4	Well Done	19 - 23 minutes
Hamburgers, 3/4” thick	4	Well Done	15 - 18 minutes
Pork			
Bacon	4	Well Done	6 - 10 minutes
Chops, 1”	4	Well Done	22 - 26 minutes
Ham - precooked slice, 1/2” thick	4	Warm	8 - 12 minutes
Poultry			
Chicken Pieces	3 or 4	Well Done	LO Broil 28 - 38 minutes
Seafood			
Fish Steaks, buttered, 1” thick	4	Flaky	10 - 15 minutes
Filletts	4	Flaky	8 - 12 minutes

* The top rack position is #5.

Important: This chart is a suggested guide. The times may vary with the food being cooked.

Automatic Shut-Off/Sabbath Mode

The oven will automatically turn off after 12 hours if you accidentally leave it on. This safety feature can be turned off.

To cancel the 12-hour shut-off and run the oven continuously for 72 hours:

1. Set the oven to bake (see page 14).
2. Press and hold the **CLOCK** pad for *five* seconds. 
 - SAb will be displayed and flash for five seconds.
 - SAb will then be displayed continuously until turned off or until the 72-hour time limit is reached.
 - “BAKE” will also be displayed if a bake cycle is in use while the oven is in Sabbath Mode.

All other functions EXCEPT BAKE (Timer, Keep Warm, Clean, etc.) are locked out during the Sabbath Mode.

To cancel Bake when in Sabbath Mode:

Press **CANCEL**.

- “BAKE” will turn off in the display.
- No beeps will sound.



To cancel the Sabbath Mode:

1. Press the **CLOCK** pad for *five* seconds.
OR
2. After 72 hours, the Sabbath Mode will end.
 - SAb will flash for five seconds.
 - The time of day will return to the display.

Adjusting the Oven Temperature

Oven temperatures are carefully tested for accuracy at the factory. It is normal to notice some baking or browning differences between a new oven and an old one. As ranges get older, the oven temperature can shift.

You may adjust the oven temperature if you think the oven is not baking or browning correctly. To decide how much to change the temperature, set the temperature 25° higher or lower than your recipe recommends, then bake. The results of the “test” should give you an idea of how much to adjust the temperature.

To adjust the oven temperature:

1. Press **BAKE**.
2. Enter 550° by pressing the ▲ pad.
3. Press and hold the **BAKE** pad for several seconds or until 0° appears in the display.



If the oven temperature was previously adjusted, the change will be displayed. For example, if the oven temperature was reduced by 15° the display will show “-15”.

4. Press the ▲ or ▼ pad to adjust the temperature.
Each time a pad is pressed, the temperature changes by 5°. The oven temperature can be increased or decreased by 5° to 35°.
5. The time of day will automatically reappear in the display.

You do not need to readjust the oven temperature if there is a power failure or interruption. Broiling and cleaning temperatures cannot be adjusted.

Notes:

- Sabbath Mode can be turned on at any time with or without the oven on.
- Sabbath Mode cannot be turned on if the touchpads are locked out or when the door is locked.
- If the oven is baking when Sabbath Mode is set, “BAKE” will go out at the end of the baking cycle. There will be no audible beeps.
- When the Sabbath Mode is started, no preheat beep will sound.
- All prompts, messages and beeps are deactivated when Sabbath Mode is active.
- Pressing CANCEL will cancel a Bake cycle, however the control will stay in the Sabbath Mode.
- If power fails, the oven will power up in Sabbath Mode with 72 hours remaining and no cycle active.

Oven Vent

When the oven is in use, the area near the vent may become hot enough to cause burns. Never block the vent opening.

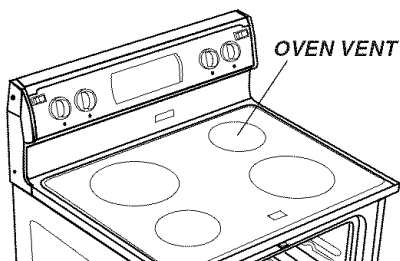

- Be sure the drip bowl in the vent location has a hole in the center. **Do not** cover the drip bowl with aluminum foil.

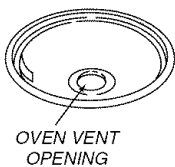

OVEN VENT
OPENING

Oven Light

Press the **oven light** switch on the control panel to turn the oven light on and off.

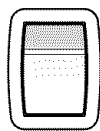

oven light

Oven Bottom

Protect oven bottom against spillovers, especially acidic or sugary spills, as they may discolor the porcelain enamel. Use the correct pan size to avoid spillovers and boilovers. **Do not place utensils or aluminum foil directly on the oven bottom.**

Oven Racks

⚠ CAUTION

- **Do not** attempt to change the rack position when the oven is hot.
- **Do not** use the oven for storing food or cookware.

The oven has two racks. All racks are designed with a lock-stop edge.

To remove:

1. Pull rack straight out until it stops at the lock-stop position.
2. Lift up on the front of the rack and pull out.

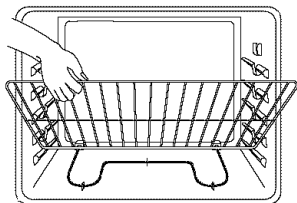

To replace:

1. Place rack on the rack support in the oven
2. Tilt the front end up slightly. Slide rack back until it clears the lock-stop position.
3. Lower front and slide back into the oven.

Do not cover an entire rack with aluminum foil or place foil on the oven bottom. Baking results will be affected and damage may occur to the oven bottom.

Rack Positions

RACK 5 (highest position): Used for toasting bread or broiling thin, non-fatty foods.

RACK 4: Used for most broiling.

RACK 3: Used for most baked goods on a cookie sheet or jelly roll pan, layer cakes, fruit pies, or frozen convenience foods.

RACK 2: Used for roasting small cuts of meat, casseroles, baking loaves of bread, bundt cakes or custard pies.

RACK 1: Used for roasting large cuts of meat and poultry, frozen pies, dessert souffles or angel food cake.

MULTIPLE RACK COOKING:

Use rack positions 2 and 4, or 1 and 4.

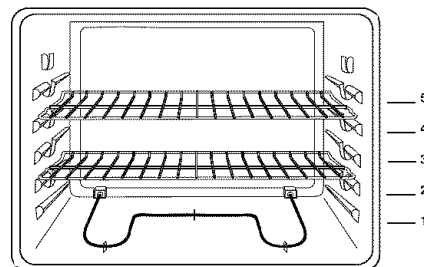

Half Rack Accessory

A half rack, to increase oven capacity, is available as an accessory. It fits in the left, upper portion of the oven and provides space for a vegetable dish when a large roaster is on the lower rack. Contact your dealer for the "HALFRACK" Accessory Kit or call 1-877-232-6771 USA or 1-800-688-8408 Canada.

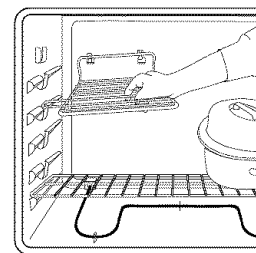

Warranty & Service

Warranty

Limited One Year Warranty - Parts and Labor

For **one (1) year** from the original retail purchase date, any part which fails in normal home use will be repaired or replaced free of charge.

Canadian Residents

The above warranties only cover an appliance installed in Canada that has been certified or listed by appropriate test agencies for compliance to a National Standard of Canada unless the appliance was brought into Canada due to transfer of residence from the United States to Canada.

*The specific warranties expressed above are the **ONLY** warranties provided by the manufacturer. These warranties give you specific legal rights, and you may also have other rights which vary from state to state.*

CUSTOMER'S SOLE AND EXCLUSIVE REMEDY UNDER THIS LIMITED WARRANTY SHALL BE PRODUCT REPAIR AS PROVIDED HEREIN. IMPLIED WARRANTIES, INCLUDING WARRANTIES OF MERCHANTABILITY OR FITNESS FOR A PARTICULAR PURPOSE, ARE LIMITED TO ONE YEAR OR THE SHORTEST PERIOD ALLOWED BY LAW. MAYTAG CORPORATION SHALL NOT BE LIABLE FOR INCIDENTAL OR CONSEQUENTIAL DAMAGES. SOME STATES AND PROVINCES DO NOT ALLOW THE EXCLUSION OR LIMITATION OF INCIDENTAL OR CONSEQUENTIAL DAMAGES, OR LIMITATIONS ON THE DURATION OF IMPLIED WARRANTIES OF MERCHANTABILITY OR FITNESS, SO THESE EXCLUSIONS OR LIMITATIONS MAY NOT APPLY TO YOU. THIS WARRANTY GIVES YOU SPECIFIC LEGAL RIGHTS AND YOU MAY ALSO HAVE OTHER RIGHTS, WHICH VARY STATE TO STATE OR PROVINCE TO PROVINCE.

What is Not Covered By These Warranties

1. Conditions and damages resulting from any of the following:
 - a. Improper installation, delivery, or maintenance.
 - b. Any repair, modification, alteration, or adjustment not authorized by the manufacturer or an authorized servicer.
 - c. Misuse, abuse, accidents, or unreasonable use, or acts of God.
 - d. Incorrect electric current, voltage, electrical and/ or gas supply.
 - e. Improper setting of any control.
2. Warranties are void if the original serial numbers have been removed, altered, or cannot be readily determined.
3. Light bulbs, water filters and air filters.
4. Products purchased for commercial or industrial use.
5. The cost of service or service call to:
 - a. Correct installation errors. For products requiring ventilation, rigid metal ducting must be used.
 - b. Instruct the user on the proper use of the product.
 - c. Transport the appliance to and from the servicer.
6. Any food loss due to refrigerator or freezer product failures.
7. Expenses for travel and transportation for product service in remote locations.
8. Outside of the United States and Canada this warranty does not apply. Contact your dealer to determine if another warranty applies.
9. Consequential or incidental damages sustained by any person as a result of any breach of these warranties. Some states do not allow the exclusion or limitation of consequential or incidental damages, so the above exclusion may not apply.

If You Need Service

First see the Troubleshooting section in your Use and Care Guide or call the dealer from whom your appliance was purchased or call Maytag Services, LLC, Customer Assistance at 1-800-688-9900 USA and 1-800-688-2002 Canada to locate an authorized servicer.

- Be sure to retain proof of purchase to verify warranty status. Refer to WARRANTY for further information on owner's responsibilities for warranty service.
- If the dealer or service company cannot resolve the problem, write to Maytag Services, LLC, Attn: CAIR® Center, P.O. Box 2370, Cleveland, TN 37320-2370, or call **1-800-688-9900 USA and 1-800-688-2002 Canada**. U.S. customers using TTY for deaf, hearing impaired or speech impaired, call 1-800-688-2080.
- User's guides, service manuals and parts information are available from Maytag Services, LLC, Customer Assistance.

Notes: When writing or calling about a service problem, please include:

- a. Your name, address and telephone number;
- b. Model number and serial number;
- c. Name and address of your dealer or servicer;
- d. A clear description of the problem you are having;
- e. Proof of purchase (sales receipt).