

Use & Care Manual

Dual Fuel Range

Slide-in Models

Welcome 2



Important Safety Instructions .. 3-5



Features at a Glance 6



Before Setting
Surface Controls 7



Setting Surface Controls 8



Before Setting
Oven Controls 9-10



Setting Warm & Serve Drawer Controls
(Some models) 10-11

Setting Oven Controls 11



Cooking Informations 12-13



Care & Cleaning 14-19



Adjusting Your
Oven Temperature 19

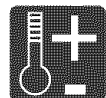

Before You Call
Solutions to
Common Problems 20-21



Warranty 22



Visit the Frigidaire Web Site at:
<http://www.frigidaire.com>



Welcome & Congratulations

Questions?

1-800-944-9044

(United States)

1-866-294-9911

(Canada)

Please attach sales receipt here for future reference.

Congratulations on your purchase of a new appliance! At **Electrolux Home Products**, we are very proud of our product and are completely committed to providing you with the best service possible. Your satisfaction is our number one priority.

We know you'll enjoy your new appliance and **Thank You** for choosing our product. We hope you consider us for future purchases.

PLEASE CAREFULLY READ AND SAVE THESE INSTRUCTIONS

This Use & Care Manual contains general operating instructions for your appliance and feature information for several models. Your product **may not** have all the described features. The graphics shown are representative. The graphics on your appliance may not look exactly like those shown. These instructions are not meant to cover every possible condition and situation that may occur. Common sense and caution must be practiced when installing, operating and maintaining any appliance.

Please record your model and serial numbers below for future reference.

Model Number: _____

Serial Number: _____

Purchase Date: _____

Product Registration

Register Your Product

The **PRODUCT REGISTRATION CARD** should be filled in completely, signed and returned to Electrolux Home Products.

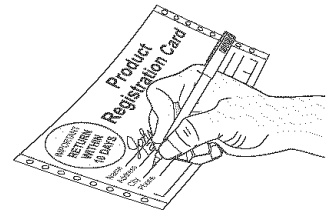

Serial Plate Location

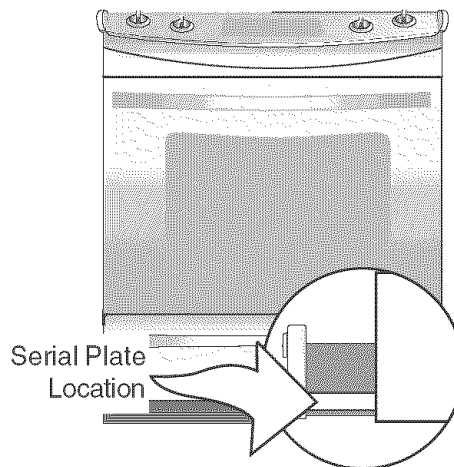

Versión en español

Si desea obtener una copia en español de este Manual del Usuario, sírvase escribir a la dirección que se incluye a continuación. Solicite la P/N 318203875E.

Spanish Use & Care Manual
Electrolux Home Products
P. O. Box 212378
Augusta, GA 30917

Important Safety Instructions



Read all instructions before using this appliance.

Save these instructions for future reference.

This manual contains important safety symbols and instructions. Please pay attention to these symbols and follow all instructions given.

⚠ WARNING This symbol will help alert you to situations that may cause serious bodily harm, death or property damage.

⚠ CAUTION This symbol will help alert you to situations that may cause bodily injury or property damage.

⚠ WARNING If the information in this manual is not followed exactly, a fire or explosion may result causing property damage, personal injury or death.

FOR YOUR SAFETY:

- Do not store or use gasoline or other flammable vapors and liquids in the vicinity of this or any other appliance.
- **WHAT TO DO IF YOU SMELL GAS:**
 - Do not try to light any appliance.
 - Do not touch any electrical switch; do not use any phone in your building.
 - Immediately call your gas supplier from a neighbor's phone. Follow the gas supplier's instructions.
 - If you cannot reach your gas supplier, call the fire department.
- Installation and service must be performed by a qualified installer, servicer or the gas supplier.

⚠ WARNING

- All ranges can tip.
- Injury to persons could result.
- Install anti-tip device packed with range.
- See Installation Instructions.



⚠ WARNING To reduce the risk of tipping, the range must be secured by properly installed anti-tip bracket(s) provided with the range. To check if the bracket(s) is installed properly, remove the lower panel or storage drawer and verify that the anti-tip bracket(s) is engaged. Refer to the Installation Instructions for proper anti-tip bracket(s) installation.

- **Remove all tape and packaging before using the range.** Destroy the carton and plastic bags after unpacking the range. Never allow children to play with packaging material.
- **Proper Installation—Be sure your appliance is properly installed and grounded by a qualified technician in accordance with Canadian Standards CAN/CGA B149.1, and CAN/CGA B149.2 and Canadian Electrical Code, part 1, and local requirements.** Install only per installation instructions provided in the literature package for this appliance.

Ask your dealer to recommend a qualified technician and an authorized repair service. Know how to disconnect the electrical power to the appliance at the circuit breaker or fuse box in case of an emergency.

- **User servicing—Do not repair or replace any part of the appliance unless specifically recommended in the manuals.** All other servicing should be done only by a qualified technician. This may reduce the risk of personal injury and damage to the range.
- **Never modify or alter the construction of a range by removing leveling legs, panels, wire covers, anti-tip brackets/screws, or any other part of the product.**

⚠ WARNING Stepping, leaning or sitting on the door or drawer of this range can result in serious injuries and also cause damage to the range. Do not allow children to climb or play around the range. The weight of a child on an open door may cause the range to tip, resulting in serious burns or other injury.

⚠ WARNING Do not use the oven or warmer drawer (if equipped) for storage.

⚠ CAUTION Do not store items of interest to children in the cabinets above a range. Children climbing on the range to reach items could be seriously injured.

⚠ WARNING NEVER use this appliance as a space heater to heat or warm the room. Doing so may result in carbon monoxide poisoning and overheating of the oven.

- **Storage in or on Appliance—Flammable materials should not be stored in an oven, near surface burners or in the drawer (if equipped).** This includes paper, plastic and cloth items, such as cookbooks, plasticware and towels, as well as flammable liquids. Do not store explosives, such as aerosol cans, on or near the appliance. Flammable materials may explode and result in fire or property damage.



Important Safety Instructions

- **Do not leave children alone**—Children should not be left alone or unattended in the area where appliance is in use. They should never be allowed to sit or stand on any part of the appliance.
- **DO NOT TOUCH SURFACE BURNERS, AREAS NEAR THESE BURNERS, OVEN BURNERS OR INTERIOR SURFACES OF THE OVEN OR WARMER DRAWER (if equipped).** Both surface burners and oven burners may be hot even though flames are not visible. Areas near surface burners may become hot enough to cause burns. During and after use, do not touch, or let clothing or other flammable materials touch these areas until they have had sufficient time to cool. Among these areas are the cooktop, surfaces facing the cooktop, the oven vent openings and surfaces near these openings, oven door and window.
- **Wear proper apparel**—Loose-fitting or hanging garments should never be worn while using the appliance. Do not let clothing or other flammable materials contact hot surfaces.
- **Do not use water or flour on grease fires**—Smother the fire with a pan lid, or use baking soda, a dry chemical or foam-type extinguisher.
- **When heating fat or grease, watch it closely.** Fat or grease may catch fire if allowed to become too hot.

⚠ WARNING In case of fire or gas leak, be sure to turn off the main gas shutoff valve.

- **Use only dry potholders**—Moist or damp potholders on hot surfaces may result in burns from steam. Do not let potholders touch hot heating burners. Do not use a towel or other bulky cloth instead of a potholder.
- **Do not heat unopened food containers**—Buildup of pressure may cause container to burst and result in injury.
- **Remove the oven door from any unused range if it is to be stored or discarded.**

IMPORTANT—Do not attempt to operate the oven during a power failure. If the power fails, always turn off the oven. If the oven is not turned off and the power resumes, the oven may begin to operate again. Once the power resumes, reset the clock and oven function.

⚠ CAUTION Electronic controllers can be damaged by cold temperatures. When you use your appliance for the first time, or if it has not been used for a long period of time, make sure that it has been exposed to a temperature above 0°C/32°F for at least 3 hours before connecting it to the power supply.

IMPORTANT INSTRUCTIONS FOR USING YOUR COOKTOP

⚠ WARNING Use proper flame size—Adjust flame size so it does not extend beyond the edge of the utensil. The use of undersized utensils will expose a portion of the burner flame to direct contact and may result in ignition of clothing. Proper relationship of utensil to flame will also improve efficiency.

⚠ WARNING Do not use stove top grills on the burner grates of sealed gas burners. If you use a stove top grill on a sealed gas burner, it will cause incomplete combustion and can result in exposure to carbon monoxide levels above allowable current standards. This can be hazardous to your health.

- **Know which knob controls each surface burner.** Place a pan of food on the burner before turning it on, and turn the burner off before removing the pan.
- **Always turn the knob to the full LITE position when igniting top burners.** Visually check that burner has lit. Then adjust the flame so it does not extend beyond the edge of the utensil.
- **Use proper pan size.** This appliance is equipped with one or more surface burners of different sizes. Select utensils having flat bottoms large enough to cover the surface burner. The use of undersized utensils will expose a portion of the surface burner to direct contact and may result in ignition of clothing. Proper relationship of utensil to the surface burner will also improve efficiency.
- **Utensil handles should be turned inward and not extend over adjacent surface burners.** To reduce the risk of burns, ignition of flammable materials, and spillage due to unintentional contact with the utensil, the handle of the utensil should be positioned so that it is turned inward, and does not extend to adjacent surface burners.
- **Never leave surface burners unattended at high heat settings**—Boilovers cause smoking and greasy spillovers that may ignite, or a pan that has boiled dry may melt.
- **Protective liners**—Do not use aluminum foil to line surface burner pans, or oven bottom, except as suggested in this manual. Improper installation of these liners may result in risk of electric shock, or fire.
- **Glazed cooking utensils**—Only certain types of glass, glass/ceramic, ceramic, earthenware, or other glazed utensils are suitable for range top service without breaking due to the sudden change in temperature. Check the manufacturer's recommendations for cooktop use.
- **Do not use Searing Grill on the cooktop.** The searing grill is not designed for use on the cooktop. Doing so may result in a fire.

Important Safety Instructions



- **Do not use decorative surface burner covers.** If a burner is accidentally turned on, the decorative cover will become hot and possibly melt. Burns will occur if the hot covers are touched. Damage may also be done to the cooktop or burners because the covers may cause overheating. Air will be blocked from the burner and cause combustion problems.

FOR GLASS COOKTOPS ONLY

- **Do not clean or operate a broken cooktop**—If cooktop should break, cleaning solutions and spillovers may penetrate the broken cooktop and create a risk of electric shock. Contact a qualified technician immediately.
- **Clean cooktop glass with caution**—If a wet sponge or cloth is used to wipe spills on a hot cooking area, be careful to avoid a steam burn. Some cleaners can produce harmful fumes if applied to a hot surface.
- **Avoid scratching the cooktop glass with sharp objects.**

IMPORTANT INSTRUCTIONS FOR USING YOUR OVEN

- **Use care when opening oven door or warmer drawer (if equipped)**—Stand to the side of the range when opening the door of a hot oven. Let hot air or steam escape before you remove or replace food in the oven/ warmer drawer.
- **Keep oven vent ducts unobstructed.** The oven vent is located at the center rear of the cooktop. Touching the surfaces in this area when the oven is operating may cause severe burns. Also, do not place plastic or heat-sensitive items on or near the oven vent. These items could melt or ignite.
- **Placement of oven/warmer drawer (if equipped) racks.** Always place oven racks in desired location while oven/warmer drawer (if equipped) is cool. If rack must be moved while oven is hot use extreme caution. Use potholders and grasp the rack with both hands to reposition. Do not let potholders contact the hot heating elements in the oven/warmer drawer (if equipped). Remove all utensils from the rack before moving.

- **Do not use a broiler pan without its insert.** The broiler pan and its insert allow dripping fat to drain and be kept away from the high heat of the broiler.
- **Do not cover the broiler insert with aluminum foil.** Exposed fat and grease could ignite.
- **Do not touch a hot light bulb with a damp cloth.** Doing so could cause the bulb to break. Disconnect the appliance or turn off the power to the appliance before removing and replacing light bulb.

IMPORTANT INSTRUCTIONS FOR CLEANING YOUR RANGE

- **Clean the range regularly to keep all parts free of grease that could catch fire.** Exhaust fan ventilation hoods and grease filters should be kept clean. Do not allow grease to accumulate on hood or filter. Greasy deposits in the fan could catch fire. When you are flaming food under the hood, turn the fan on. Refer to the hood manufacturer's instructions for cleaning.

SELF-CLEANING OVENS

- **In the self-Cleaning cycle only clean the parts listed in this Use and Care Guide.** Before self-cleaning the oven, remove all utensils or foods from the oven.
- **Do not use oven cleaners**—No commercial oven cleaner or oven liner protective coating of any kind should be used in or around any part of the oven.
- **Do not clean door gasket**—The door gasket is essential for a good seal. Care should be taken not to rub, damage or move the gasket.
- **Remove oven racks.** Oven racks color will change if left in the oven during a self-cleaning cycle.

⚠ CAUTION The health of some birds is extremely sensitive to the fumes given off during the self-cleaning cycle of the range. Move the birds to another well ventilated room.

SAVE THESE INSTRUCTIONS

Conversion to Liquefied Petroleum Gas (or L.P. Gas)

This natural gas range is designed to allow for conversion to Liquefied Petroleum (L.P.) Gas.

If L.P. conversion is needed, contact the service center for assistance. The L.P. Conversion Kit is provided with this range and is located on the right panel (right side) of the range. Before installing the kit be sure to follow the L.P. Installation Instructions carefully.

⚠ WARNING Personal injury or death from electrical shock may occur if the range is not installed by a qualified installer or electrician.

⚠ CAUTION Any additions, changes or conversions required in order for this appliance to satisfactorily meet the application needs must be made by an authorized Service Center.



Features At A Glance

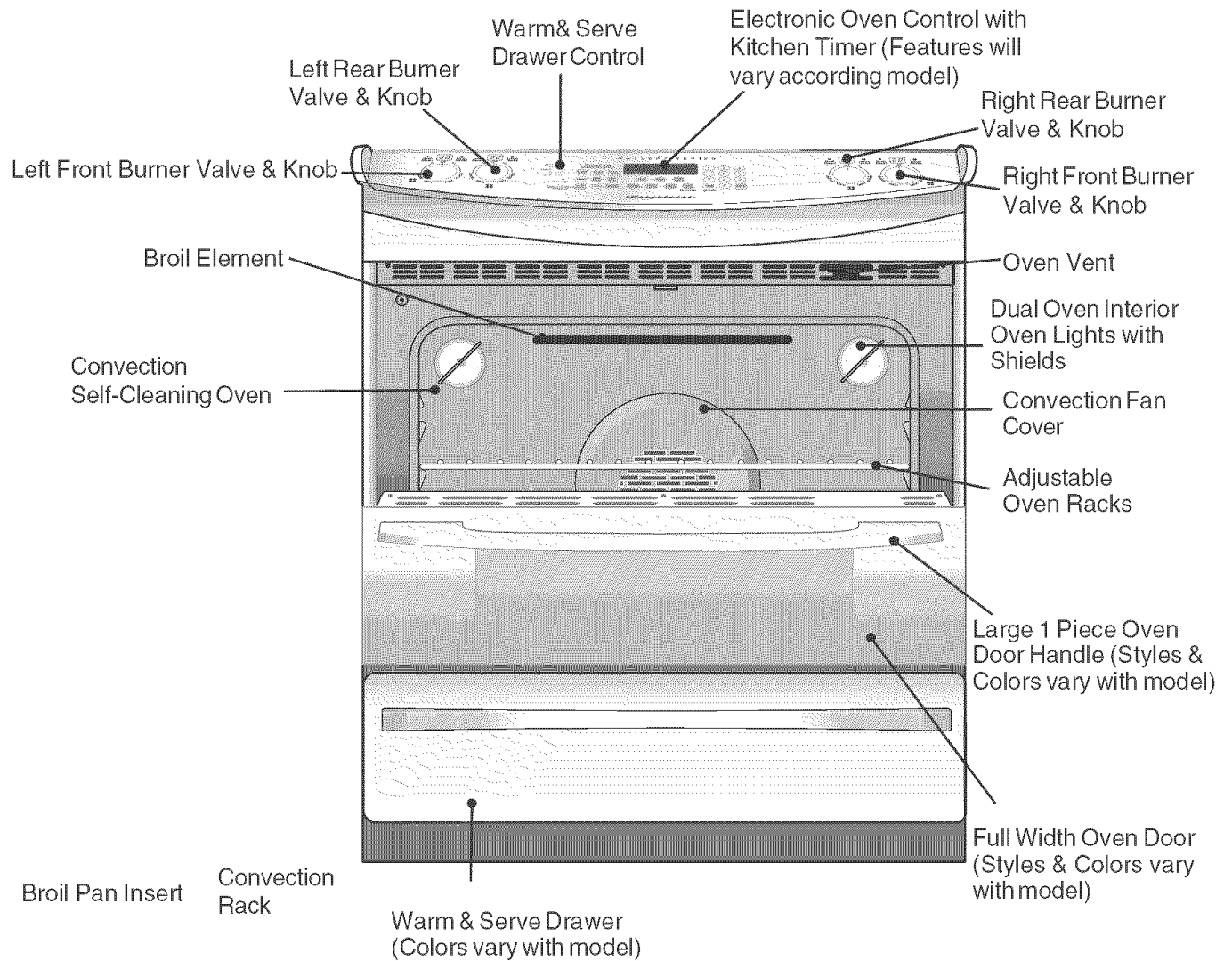

Broil Pan

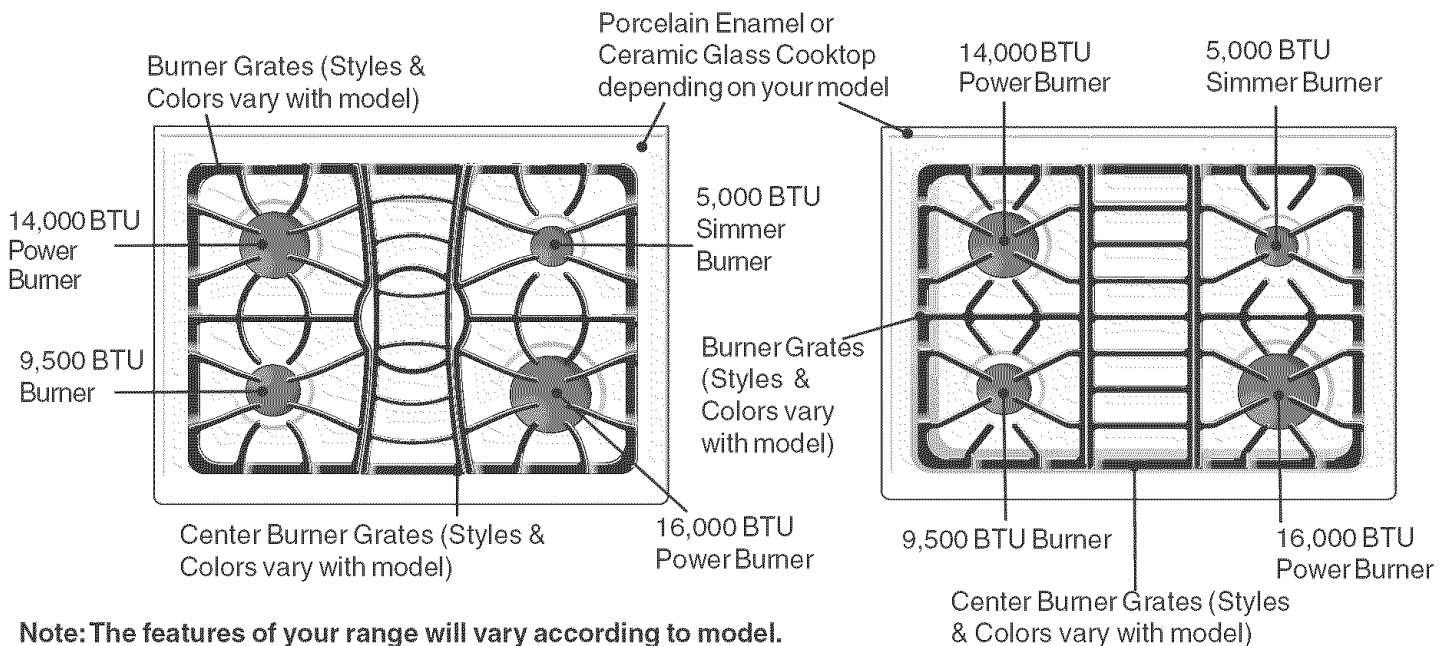

Note: The features of your range will vary according to model.

Before Setting Surface Controls



Assembly of the Surface Burner Heads, Burner Caps and Burner Grates

It is very important to make sure that all of the Surface Burner Heads, Surface Burner Caps and Surface Burner Grates are installed correctly and at the correct locations.

1. Remove all packing tape from cooktop area. Remove all Burner Caps and Burner Heads.
2. Discard all packing material located under Burner Heads (if applicable).
3. To replace the Burner Heads & Caps, match the letters located under center of Burner Caps with the letters located inside Burner Heads (Figure 1).
4. Match Burner Skirts with Burner Heads and Burner Caps (see Figure 1). Replace the Burner Heads and Caps on cooktop (see Figure 2). Carefully align the Electrodes into slot or hole of each Burner Head (Figure 3). Note: The Burner Heads should sit flat on Cooktop Burner Skirts.
5. Unpack Burner Grates and position on the cooktop.

REMEMBER — DO NOT ALLOW SPILLS, FOOD, CLEANING AGENTS OR ANY OTHER MATERIAL TO ENTER THE GAS ORIFICE HOLDER OPENING. Always keep the Burner Caps and Burner Heads in place whenever the surface burners are in use.

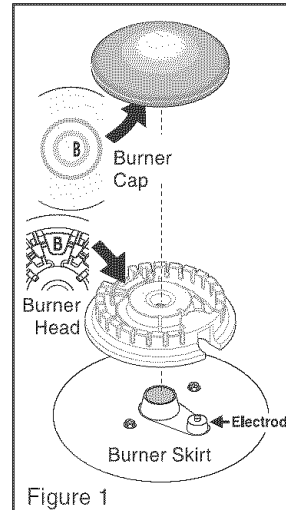

Figure 1

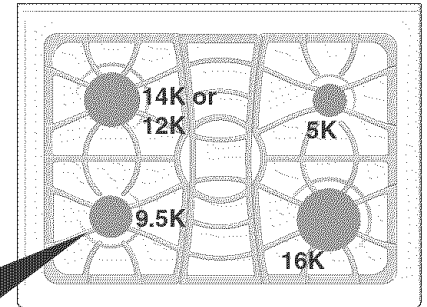

Figure 2

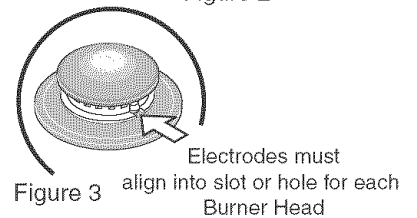

Figure 3

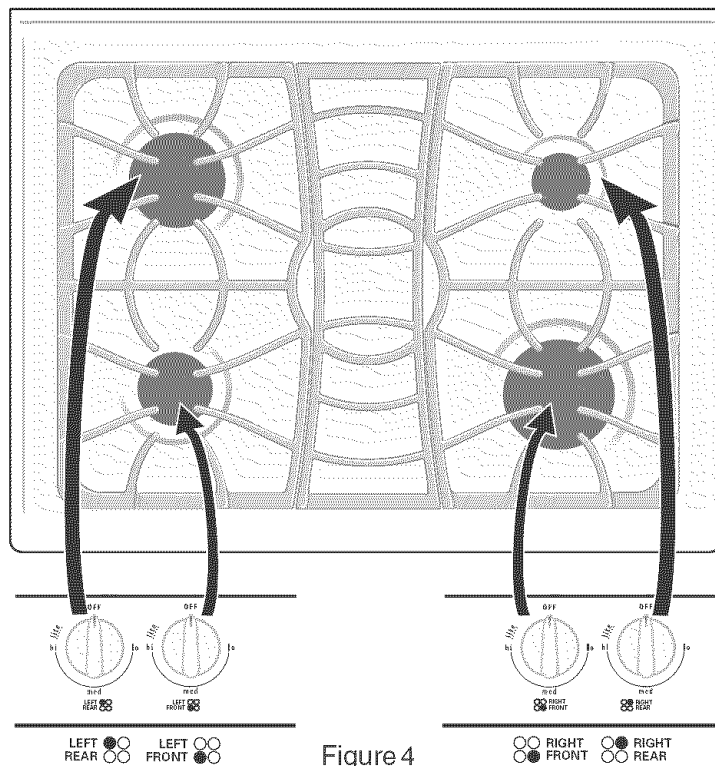

Figure 4

Control Locations of the Gas Surface Burners

Your range is equipped with gas surface burners with different BTU ratings. The ability to heat food quicker and in larger volumes increases as the burner size increases.

The small **SIMMER** burner is best used for simmering delicate sauces, etc. This burner is located at the right rear burner position on the cooktop (see Figure 4).

The **STANDARD** burner can be used for most surface cooking needs. The 2 burners are located at the left front position on the cooktop (see Figure 4).

The **POWER** burners are best used for bringing large quantities of liquid rapidly up to temperature or when preparing larger quantities of food. The 2 **POWER** burners are located at the right front and left rear burner positions on the cooktop (see Figure 4).

Regardless of size, always select cookware that is suitable for the amount and type of food being prepared. Select a burner and flame size appropriate to the pan. Never allow flames to extend beyond the outer edge of the pan.



Setting Surface Controls

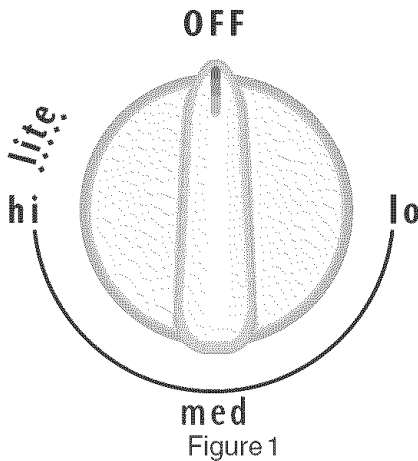

Operating the Gas Surface Controls:

1. Place cooking utensil on surface burner.
2. Push the surface control knob down and turn **counterclockwise** out of the OFF position.
3. Release the knob and rotate to the LITE position (see figure 1). Note: All four electronic surface ignitors will spark at the same time. However, only the burner you are turning on will ignite.
4. Visually check that the burner has a flame.
5. Turn the control knob **counterclockwise** to the desired flame size. The control knobs do not have to be set at a particular setting. Use the knob indicator settings to adjust the flame as needed. **DO NOT** cook with the surface control knob in the LITE position. (The electronic ignitor will continue to spark if the knob is left in the LITE position.)

CAUTION Do not place plastic items such as salt and pepper shakers, spoon holders or plastic wrappings on top of the range when it is in use. These items could melt or ignite. Potholders, towels or wood spoons could catch fire if placed too close to a flame.

In the event of an electrical power outage, the surface burners can be lit manually. To light a surface burner, hold a lit match to the burner head, then slowly turn the surface control knob to **LITE**. After burner lights turn the knob to desired setting. Use caution when lighting surface burners manually.

Setting Proper Surface Burner Flame Size

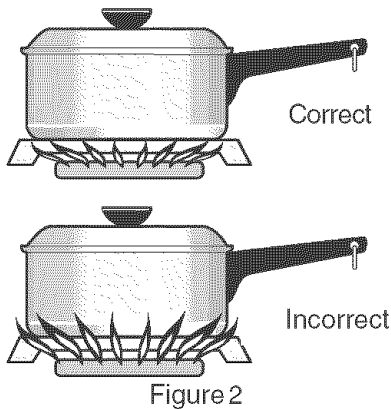

For most cooking - start on the highest control setting and then turn to a lower one to complete the process. Use the recommendations below as a guide for determining proper flame size for various types of cooking. The size and type of utensil used and the amount of food being cooked will influence the setting needed.

***Flame Size**
 High Flame
 Medium Flame
 Low Flame

Type of Cooking
 Start most foods; bring water to a boil; pan broiling.
 Maintain a slow boil; thicken sauces, gravies; steaming.
 Keep foods cooking; poach; stewing.

For deep fat frying - use a thermometer and adjust the surface control knob accordingly. If the fat is too cool, the food will absorb the fat and be greasy. If the fat is too hot, the food will brown so quickly that the center will be undercooked. Do not attempt to deep fat fry too much food at once as the food will neither brown nor cook properly.

Never extend the flame beyond the outer edge of the utensil. A higher flame simply wastes heat and energy, and increases the risk of being burned by the gas flame.

***Note: Settings are based on using medium-weight metal or aluminum pans. Settings may vary when using other types of pans.** The color of the flame is the key to proper burner adjustment. A good flame is clear, blue and hardly visible in a well-lighted room. Each cone of flame should be steady and sharp. Adjust or clean burner if flame is yellow-orange.

Before Setting Oven Controls



CAUTION This range has a fan that will turn “ON” and “OFF” by itself to keep the electronics cool. It may continue to run after the range has been turned “OFF” but may also stop immediately to turn “ON” after a while.

Arranging Oven Racks

ALWAYS ARRANGE OVEN RACKS WHEN THE OVEN IS COOL (PRIOR TO OPERATING THE OVEN). Always use oven mitts when the oven is hot.

Oven Vent Location

The oven vent is located in the center rear on the cooktop. When the oven is on, warm air passes through the vent. This venting is necessary for proper air circulation in the oven and good baking results. **DO NOT BLOCK OVEN VENT.** Never close off the openings with aluminum foil or any other material.

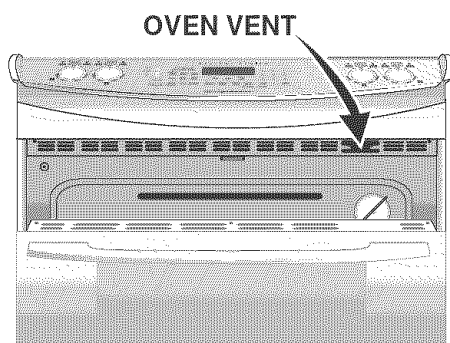

Removing and Replacing Oven Racks

To remove, pull the rack forward until it stops. Lift up front of rack and slide out. **To replace**, fit the rack onto the guides on the oven walls. Tilt the front of the rack upward and slide the rack back into place.

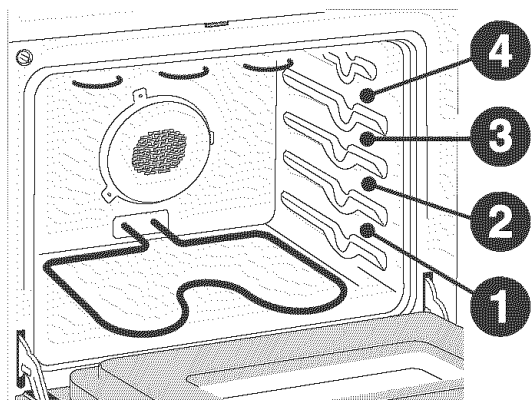
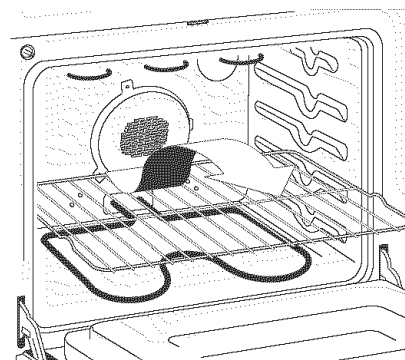

RECOMMENDED RACK POSITIONS FOR BROILING, BAKING & ROASTING

Food	Rack position
Broiling meats, chicken or fish	3 or 4
Cookies, cakes, pies, biscuits & muffins	2 or 3
Frozen pies, angel food cake, yeast, bread, casseroles, small cuts of meat or poultry	1 or 2
Turkey, roast or ham	1

Note: Always use caution when removing food.



Before Setting Oven Controls

Air Circulation in the Oven

For best air circulation and baking results allow 2-4" (5-10 cm) around the cookware for proper air circulation and be sure pans and cookware do not touch each other, the oven door, sides or back of the oven cavity. The hot air must circulate around the pans and cookware in the oven for even heat to reach around the food.

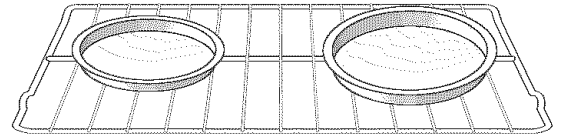

1 Oven Rack

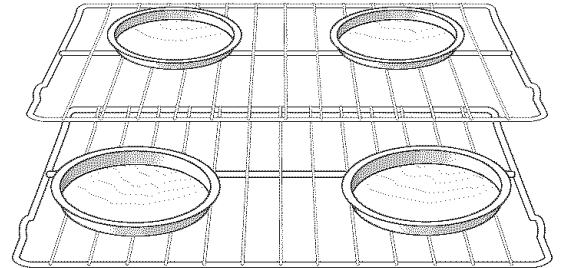

Multiple Oven Racks



Setting Warm & Serve Drawer Controls (some models)

Arranging Warm & Serve Drawer Rack Positions

The rack can be used in 2 ways:

- In the **upward position** (Figure 1) to allow low profile food items to be placed both under and on top of the rack (for example, rolls or biscuits on top of the rack and a casserole dish underneath).
- In the **downward position** (Figure 2) to allow you to place light weight food items and empty dishware (for example, rolls or pastries and dinner plates) on the rack.

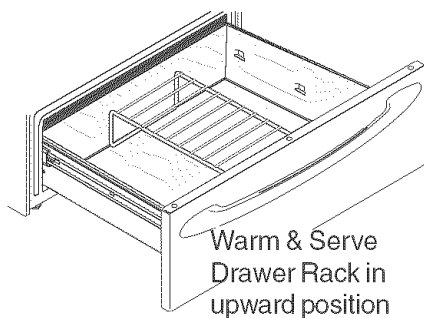

Figure 1

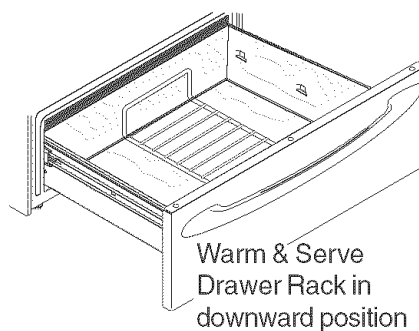

Figure 2

CAUTION Always use potholders or oven mitts when removing food from the Warmer Drawer as cookware and plates will be hot and you can be burned.

Using the Warm & Serve Drawer

The purpose of the Warm & Serve Drawer is to keep hot cooked foods at serving temperature. Always start with hot food. It is not recommended to heat cold food in the Warm & Serve Drawer. All food placed in the Warm & Serve Drawer should be covered with a lid or aluminum foil to maintain quality.

Do not use plastic wrap to cover food. Plastic may melt onto the drawer and be very difficult to clean. Use only utensils and cookware recommended for oven use in the Warm & Serve Drawer.

Note: The Warm & Serve Drawer will not operate during the self-Clean cycle.

Setting Warm & Serve Drawer Controls (some models)

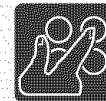







Warm & Serve Drawer Temperature Selection

Recommended Warm & Serve Drawer settings table is shown aside. If a particular food is not listed, start with the **MED** setting. If more crispness is desired, remove the lid or aluminum foil from the food. Most foods can be kept at serving temperatures on the **MED** setting. When a combination of foods are to be kept warm (for instance, meat with 2 vegetables and rolls), use the **HI** setting. To avoid heat loss, do not open the Warmer Drawer while in use.

To Set the Warm & Serve Drawer Controls:

The control and indicator lights for the Warm & Serve Drawer features are located on the control panel. The temperatures are approximate, and are designated by **HI** (high), **MED** (medium) and **LO** (low).

1. Touch the  pad at the Warm & Serve Drawer control position (see Figure 4). The Warm & Serve Drawer indicator light will flash. Note: If no further pads are touched within 25 seconds the request to power the Warm & Serve Drawer ON will clear.
2. Set the desired power level. Touch  once to turn ON the power level for HI (see Figure 1) or  to turn ON the power level for LO (see Figure 3). The Warm & Serve Drawer indicator light located beside the  pad will turn ON steady.

3. Each touch of the  or  pads will decrease or increase through 6 power levels from **HI** (see Figure 1) to **MED** (see Figure 2) to **LO** (see Figure 3). Note: For best results, preheat the Warm & Serve Drawer before adding the food. An empty drawer will preheat in approximately 15 minutes.
4. When the food is ready for removal, touch the  pad once to turn the Warm & Serve Drawer OFF. The Warm & Serve Drawer indicator light will turn OFF.

Note: The Warm & Serve drawer is equipped with a catch which may require extra force when opening and closing the drawer.

Warm & Serve Drawer recommended Food Settings Table	
Food Item	Setting
Bacon	HI
Hamburger Patties	HI
Poultry	HI
Pork Chops	HI
Fried Foods	HI
Pizza	HI
Gravies	MED
Casseroles	MED
Eggs	MED
Roasts (Beef, Pork, Lamb)	MED
Vegetables	MED
Biscuits	MED
Rolls, hard	MED
Pastries	MED
Rolls (soft)	LO
Empty Dinner Plates	LO

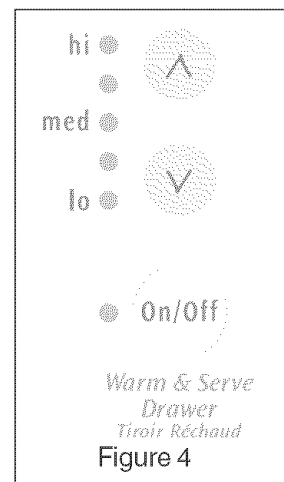
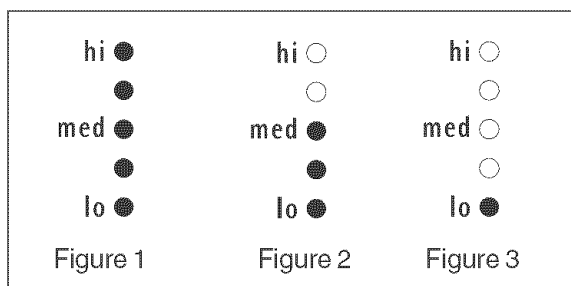

Setting Oven Controls



Refer to the Electronic Oven Control Guide for oven settings.





Cooking Informations

Oven Baking

For best cooking results, heat the oven before baking cookies, breads, cakes, pies or pastries, etc... There is no need to preheat the oven for roasting meat or baking casseroles.

The cooking times and temperatures needed to bake a product may vary slightly from your previously owned appliance.

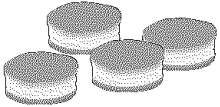
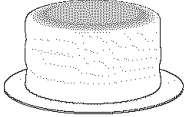
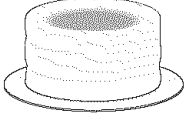
Baking Problems and Solutions Chart

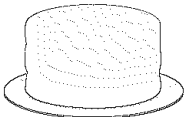
Baking Problems	Causes	Corrections
Cookies and biscuits burn on the bottom. 	<ul style="list-style-type: none"> • Cookies and biscuits put into the oven before the preheating time is completed. • Oven rack overcrowded. • Dark pan absorbs heat too fast. 	<ul style="list-style-type: none"> • Allow oven to preheat to the selected temperature before placing food in oven. • Choose pan sizes that will permit 5.1 cm to 10.2 cm (2" to 4") of air space on all sides when placed in the oven. • Use a medium-weight aluminum baking sheet.
Cakes too dark on top or bottom. 	<ul style="list-style-type: none"> • Cakes put into the oven before preheating time is completed. • Rack position too high or low. • Oven too hot. 	<ul style="list-style-type: none"> • Allow oven to preheat to the selected temperature before placing food in the oven. • Use proper rack position for baking needs. • Set oven temperature 25°F/12°C lower than recommended.
Cakes not done in the center. 	<ul style="list-style-type: none"> • Oven too hot. • Incorrect pan size. • Pan not centered in oven. 	<ul style="list-style-type: none"> • Set oven temperature 25°F/12°C lower than recommended. • Use pan size suggested in recipe. • Use proper rack position and place pan so there is 5.1 cm to 10.2 cm (2" to 4") of space on all sides of pan.
Cakes not level. 	<ul style="list-style-type: none"> • Range not level. • Pan too close to oven wall or rack overcrowded. • Pan warped. 	<ul style="list-style-type: none"> • Place a marked glass measuring cup filled with water on the center of the oven rack. If the water level is uneven, refer to the installation instructions for leveling the range. • Be sure to allow 5.1 cm to 10.2 cm (2" to 4") of clearance on all sides of each pan in the oven. • Do not use pans that are dented or warped.
Foods not done when cooking time is up. 	<ul style="list-style-type: none"> • Oven too cool. • Oven overcrowded. • Oven door opened too frequently. 	<ul style="list-style-type: none"> • Set oven temperature 25°F/12°C higher than suggested and bake for the recommended time. • Be sure to remove all pans from the oven except the ones to be used for baking. • Open oven door only after shortest recommended baking time.

Cooking Informations



Broiling

Broiling is a method of cooking tender cuts of meat by direct heat under the broil element of the oven.

Preheating

Preheating is suggested when searing rare steaks. (Remove your broiler pan before preheating. Foods will stick if placed on hot metal.) To preheat, set the control(s) to BROIL as instructed in the Owner's Guide. Wait for the element to become red-hot, usually about 2 minutes. Preheating is not necessary when broiling meats well-done.

To Broil

Broil on side until the food is browned; turn and cook on the second side. Season and serve. Always pull rack out to the "stop" position before turning or removing food.

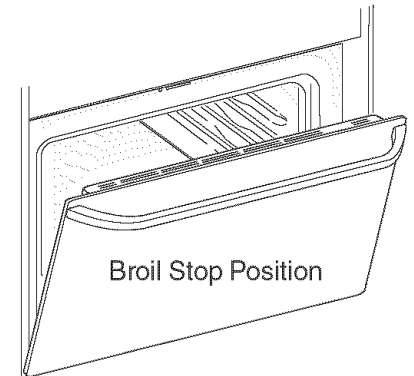

Determine Broiling Times

Broiling times vary, so watch the food closely. Time not only depends on the distance from element, but on the thickness and aging of meat, fat content and doneness preferred. The first side usually requires a few minutes longer than second. Frozen meats also require additional time.

Broiling Tips (some models)

The broiler pan and its grid allow dripping grease to drain and be kept away from the high heat of the broiler.

DO NOT use a pan without its grid. DO NOT cover the grid with foil. The exposed grease could ignite.

CAUTION Should an oven fire occur, close the oven door and turn off the oven. If the fire continues, throw baking soda on the fire or use fire extinguisher. DO NOT put water or flour on the fire. Flour may be explosive.

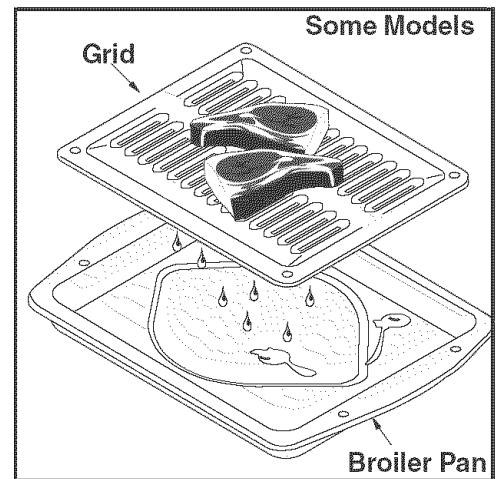

Broiler Clean-Up Tips (some models):

To make cleaning easier, line the bottom of the broiler pan with aluminum foil. DO NOT cover the broiler grid with foil. To prevent grease from baking on, remove the broiler pan from the oven as soon as cooking is completed. Use hot pads because the broiler pan is extremely hot. Pour off grease. Soak the pan in HOT, soapy water. Clean the broiler pan as soon as possible after each use. If necessary, use soap-filled steel wool pads. Heavy scouring may scratch the grid.



Care & Cleaning

Self-Cleaning

CAUTION During the Self-Cleaning cycle, the outside of the range can become very hot to the touch. **DO NOT** leave small children unattended near the appliance.

CAUTION The health of some birds is extremely sensitive to the fumes given off during the Self-Cleaning cycle of any range. Move birds to another well-ventilated room.

CAUTION **DO NOT** line the oven walls, racks, bottom or any other part of the range with **aluminum foil**. Doing so will destroy heat distribution, produce poor baking results and cause permanent damage to the oven interior (aluminum foil will melt to the interior surface of the oven).

CAUTION **DO NOT** force the oven door open. This can damage the automatic door locking system. Use caution when opening the door after the Self-Cleaning cycle is completed. The oven may still be **VERY HOT**.

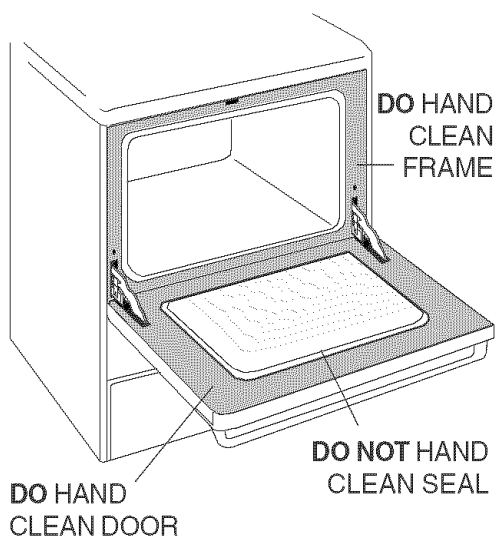

Note: See additional cleaning information for the oven door in the **General Care & Cleaning** section.

To Set the Self-Clean Cycle

Refer to the Oven Control Guide for Self-Clean Cycle settings.

Self-Cleaning Oven

A Self-Cleaning oven cleans itself with high temperatures (well above cooking temperatures) which eliminate soils completely or reduces them to a fine powdered ash you can wipe away with a damp cloth.

Adhere to the following cleaning precautions:

- **DO NOT** use oven cleaners or oven protective coatings in or around any part of the Self-Cleaning oven.
- **DO NOT** clean the oven door gasket. The woven material of the oven door gasket is essential for a good seal. Care should be taken not to rub, damage or remove the gasket.
- **DO NOT** use any cleaning materials on the oven door gasket. Doing so could cause damage.
- **Remove all utensils and any aluminum foil. These items cannot withstand high cleaning temperatures.**
- Oven racks do not have to be removed. If they are not removed during the Self-Clean cycle their color will turn slightly blue and the finish will be dull. After the cycle is complete and the oven has cooled, rub the sides of the oven racks with wax paper or a cloth containing a small amount of salad oil (this will make the racks glide easier into the rack position).
- **Remove any excessive spillovers** in the oven cavity **before** starting the Self-Cleaning cycle. To clean, use hot, soapy water and a cloth. Large spillovers can cause heavy smoke or fire when subjected to high temperatures. **DO NOT** allow food spills with a high sugar or acid content (such as milk, tomatoes, sauerkraut, fruit juices or pie filling) to remain on the surface as they may leave a dull spot even after cleaning.
- Clean any soil from the oven frame, the door liner outside the oven door gasket and the small area at the front center of the oven bottom. These areas heat sufficiently to burn soil on. Clean with soap and water.

NOTE: Prior to setting the Self-Clean cycle, any spills remaining on the oven bottom should be removed.

What to Expect during Cleaning:

While the oven is in operation, the oven heats to temperatures much higher than those used in normal cooking. Sounds of metal expansion and contraction are normal. Odor is also normal as the food soil is being removed. Smoke may appear through the oven vent.

If heavy spillovers are not wiped up before cleaning, they may flame and cause more smoke and odor than usual. This is normal and safe and should not cause alarm. If available, use an exhaust fan during the self-cleaning cycle.

NOTE: A smoke eliminator in the oven vent converts most of the soil into a colorless vapor.

Care & Cleaning

(Cleaning Chart)



Surfaces	How to Clean
Aluminum (trim pieces) & Vinyl	Use hot, soapy water and a cloth. Dry with a clean cloth.
Glass, Painted and Plastic Body Parts, Control Knobs & Decorative Trim Pieces	Using a soft cloth, clean with mild dish detergent and water or a 50/50 solution of vinegar and water. Follow by rinsing the area with clean water; dry and polish with a soft cloth. Glass cleaners may be used if sprayed on a soft cloth first. DO NOT spray liquids directly on the control pad and display area. Do not use large amounts of water on the control panel - excess water on the control area may cause damage to the appliance. Do not use other liquid cleaners, abrasive cleaners, scouring pads, or paper towels - they will damage the finish. To remove control knobs, turn to the OFF position; grasp firmly and pull straight off the shaft. To replace knobs after cleaning, line up the flat sides of both the knob and the shaft; then push the knob into place.
Control Panels	<i>Before cleaning the control panel</i> , turn all controls to OFF and remove the control knobs. To remove, pull each knob straight off the shaft. Clean as instructed above. Squeeze excess water from the cloth before wiping the panel; especially when wiping around the controls. Excess water in or around the controls may cause damage to the appliance. To replace knobs after cleaning, line up the flat sides of both the knob and the shaft; then push the knob into place.
Porcelain Enamel Burner Grates, Cooktop Surface, Below Cooktop, Broiler Pan & Insert (some models), Door Liner, Oven Bottom & Burner Drip Pans	Clean burner grates, broiler pan and insert (some models) in the dishwasher and dry upon removal. If soils are not removed, follow the cooktop cleaning instructions below. Gentle scouring with a soapy scouring pad will remove most spots. Rinse with a 1:1 solution of clear water and ammonia. <i>If necessary</i> , cover difficult spots with an ammonia-soaked paper towel for 30 to 40 minutes. Rinse with clean water and a damp cloth, then scrub with a soap-filled scouring pad. Rinse and wipe dry with a clean cloth. Remove all cleaners or the porcelain may become damaged during future heating. DO NOT use spray oven cleaners on the cooktop.
Easy Care™ Stainless Steel (some models) Oven Door & Drawer Front Panel and Decorative Trim	Your range finish is may be made with Easy Care™ Stainless Steel (some models). Clean the stainless with warm soapy water using a clean sponge or cloth. Rinse with clean water and dry with a soft clean cloth. DO NOT use ANY store bought cleaners like Stainless Steel cleaners or any other types of cleaners containing any abrasive, chlorides, chlorines or ammonia. It is recommended to use mild dish soap and water or a 50/50 solution of water and vinegar.
Oven Racks	Remove racks. See "To remove and to replace an oven rack" under Oven vent(s) and racks . Use a mild, abrasive cleaner, following manufacturer's instructions. Rinse with clean water and dry. After cleaning the racks, rub the sides of the racks with wax paper or a cloth containing a small amount of baby oil or salad oil (this will make the racks glide easier into the rack positions).
Oven Door	Use soap & water to thoroughly clean the top, sides and front of the oven door. Rinse well. You may use a glass cleaner on the outside glass of the oven door. DO NOT immerse the door in water. DO NOT spray or allow water or the glass cleaner to enter the door vents . DO NOT use oven cleaners, cleaning powders or any harsh abrasive cleaning materials on the outside of the oven door. DO NOT clean the oven door gasket. The oven door gasket is made of a woven material, on Self-Cleaning models, which is essential for a good seal. Care should be taken not to rub, damage or remove this gasket.

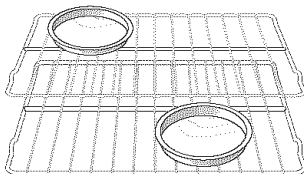



Care & Cleaning

Cleaning the Cooktop, Burner Heads, Caps & Grates

The cooktop is designed to make cleaning easier. Because the gas Burners are sealed, cleanups are easy when spillovers are cleaned up immediately.

The cooktop, Burner Heads and Caps should be routinely cleaned. Keeping the Burner Head Ports clean will prevent improper ignition and an uneven flame. Refer to the following instructions:

THE COOKTOP IS NOT REMOVABLE. Do not attempt to remove or lift the cooktop.

CAUTION Use caution when replacing the Burner Caps so the Electrodes are not damaged. This may cause a delayed ignition or prevent the burner from igniting.

CAUTION Any additions, changes or conversions required in order for this appliance to perform satisfactorily must be made by authorized servicer.

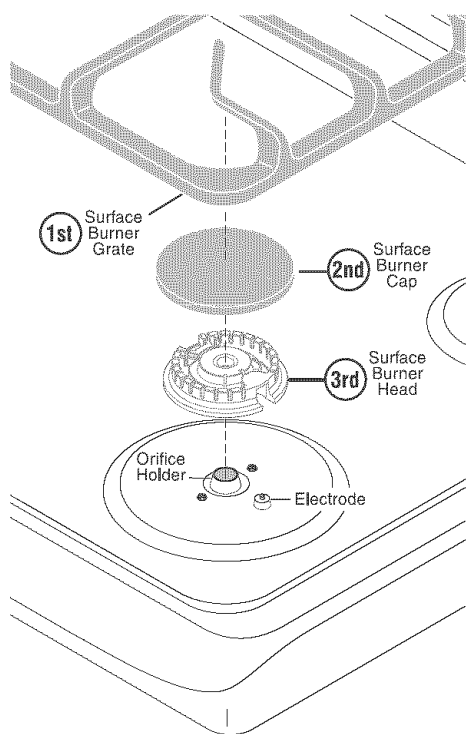

To Remove and Replace the Surface Burner Caps and Burner Heads- Remove in the following order: (1st) surface Burner Grates, (2nd) Burner Caps and (3rd) Burner Heads. Reverse the procedure above to replace the surface Burner Caps, Burner Heads and Burner Grates.

Do not remove any parts from the cooktop until they have completely cooled and are safe to handle. Do not operate the surface Burners without the Burner Caps and Burner Heads properly in place.

To Clean the surface Burner Caps and Burner Heads- Use a soap-filled scouring pad or a mild abrasive cleanser to clean the surface Burner Caps and Burner Heads. The ports (or slots) around the Burner Heads must be routinely cleaned. If residue still remains in these ports, use a small-gauge wire or needle to clean the slots or holes. For proper flow of gas and ignition of the burner—**DO NOT ALLOW SPILLS, FOOD, CLEANING AGENTS OR ANY OTHER MATERIAL TO ENTER THE GAS ORIFICE HOLDER OPENING. ALWAYS** keep the surface Burner Caps and Burner Heads in place whenever the gas Burners are in use.

To Clean the Burner Grates- The Burner Grates are dishwasher safe and may be cleaned in the dishwasher. Remove any excessive soils before placing in the dishwasher.

To Clean the Cooktop and contoured areas of the Cooktop- If a spill occurs on or in the recessed or contoured areas, blot up spill with an absorbent cloth. Rinse with a clean, damp cloth and wipe dry. Do not use harsh abrasive cleaners on the cooktop. They can scratch the porcelain. Completely rinse any mild cleaners used from the surface or the porcelain cooktop may become damaged during future heating. **DO NOT** use spray oven cleaners on the cooktop.



Care and Cleaning of Stainless Steel (Stainless Steel models only)

Some models are equipped with stainless steel exterior parts. Special care and cleaning are **required** for maintaining the appearance of stainless parts. Please refer to the table provided at the beginning of the **General Care & Cleaning** section in this Use & Care Guide.

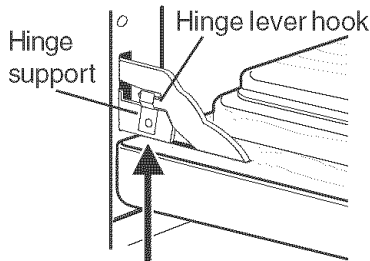

Lock engaged for door removal
Figure 1

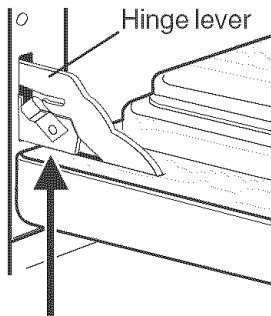
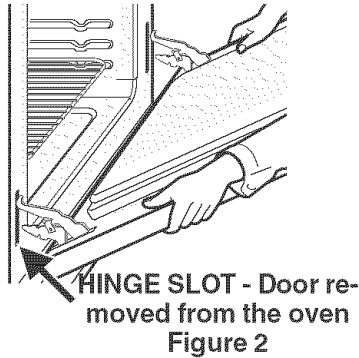

Lock in normal position
Figure 3

Removing and Replacing the Oven Door

CAUTION The door is heavy. For safe, temporary storage, lay the door flat with the inside of the door facing down.

To Remove Oven Door:

1. Open the door to the fully opened position.
2. Pull up the lock located on both hinge supports and engage it in the hinge lever hooks (Figure 1). You may have to apply a little downward pressure on the door to pull the locks fully over the hinge lever hooks.
3. Grab the door by the sides and pull the bottom of the door up and toward you to disengage the hinge supports. Keep pulling the bottom of the door toward you while rotating the top of the door toward the range to completely disengage the hinge levers (Figure 2).
4. To clean oven door, follow the instructions provided in the **General Care & Cleaning** table.

To Replace Oven Door:

1. Grab the door by the sides; place the hinge supports in the hinge slots. Open the door to the fully opened position.
2. Disengage the lock from the hinge lever hooks on both sides (Figure 3).
Note: Make sure the hinge supports are fully engaged before unlocking the hinge levers.
3. Close the oven door.

Special Door Care Instructions - Most oven doors contain glass that can break.

Read the following recommendations:

1. Do not close the oven door until all the oven racks are fully in place.
2. Do not hit the glass with pots, pans, or any other object.
3. Scratching, hitting, jarring or stressing the glass may weaken its structure causing an increased risk of breakage at a later time.



Care & Cleaning

Removing and Replacing Warm & Serve Drawer

To Remove Warm & Serve Drawer:

1. **CAUTION** Turn power off before removing the warm & Serve drawer.
2. Open the drawer to the fully opened position.
3. Locate glide lever on each side of drawer, pull up on the left glide lever and push down on the right glide lever (See Figure 1).
4. Pull the drawer away from the range.

To Replace Warm & Serve Drawer:

1. **Pull the bearing glides to the front** of the chassis glide (See Figure 2).
2. Align the glide on each side of the drawer with the glide slots on the range.
3. Push the drawer into the range until levers “click” (approximately 2”). Pull the drawer open again to seat bearing glides into position. **If you do not hear the levers “click” or the bearing glides do not feel seated remove the drawer and repeat steps 1 thru 3.** This will minimize possible damage to the bearing glides.

NOTE: The Warm & Serve Drawer will **NOT** operate while in the “Self-Clean” and “Oven Lockout” modes

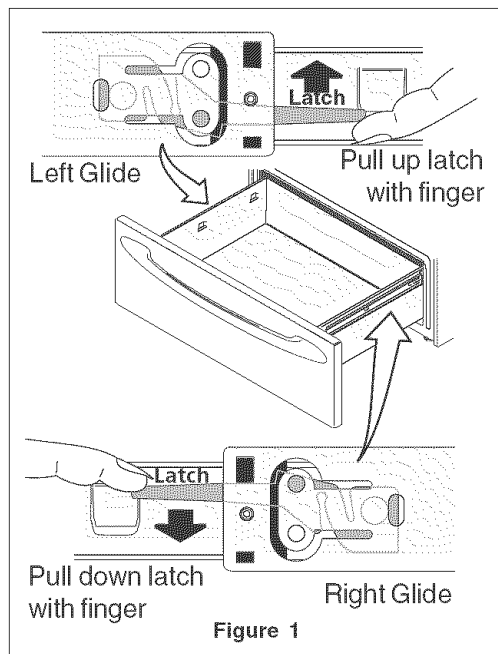

WARNING Electrical Shock Hazard can occur and result in serious injury or death. Disconnect appliance from electric power before cleaning and servicing the warm & Serve drawer.

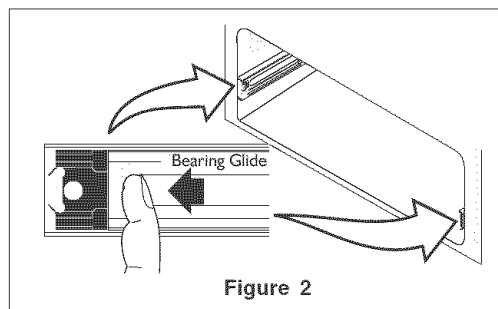

Care & Cleaning

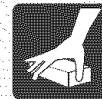

Changing Oven Light

CAUTION Be sure the oven is unplugged and all parts are COOL before replacing the oven light bulb. Do not turn the oven light on during a self-cleaning cycle. High temperature will reduce lamp life.

An interior oven light will turn on automatically when the oven is opened. The oven light may also be turned on and off when the door is closed by using the oven light switch located on the control panel or on the electronic oven control.

The oven light bulb is covered with a glass shield held in place by a wire holder. **THIS GLASS SHIELD MUST ALWAYS BE IN PLACE WHEN THE OVEN IS IN USE.**

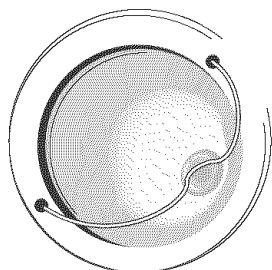

To Replace the Light Bulb:

CAUTION BE SURE OVEN IS COOL

1. Turn the power off at the main source.
2. Wear a leather-faced glove for protection against possible broken glass.
3. Replace bulb with a 40 Watt appliance bulb only.
4. For self-cleaning oven, press wire holder to one side to release glass shield, change bulb and be sure to replace glass shield.

To Remove the “Hidden Bake” Cover (some models)

1. In order to remove the “hidden bake” cover, pull the back edge with one hand about 1/2" inch and lift up the “hidden bake” cover with both hands. (See picture)
2. When re-installing the “hidden bake” cover, be sure to put it all the way to the back of the oven and lay it down on the 2 shoulder screws. Then push the front edge of the cover in its place below the front bracket.

To have easier access to the "hidden bake" cover, you can remove the oven door by following the instructions on previous page.

IMPORTANT: Always replace the “hidden bake” cover before the next use.

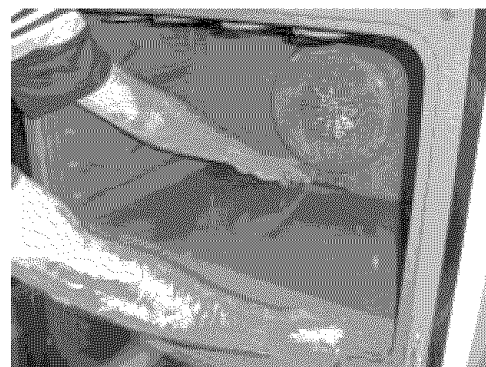

Adjusting Your Oven Temperature

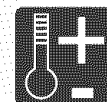

For instructions on how to adjust the oven temperature refer to the electronic oven control guide.



Before you call *Solutions to Common Problems*

OCCURRENCE

POSSIBLE CAUSE/SOLUTION

Range is not level.

Poor installation. Place oven rack in center of oven. Place a level on the oven rack. Adjust leveling legs at base of range until the rack is level. When range is level, cooktop may appear out of alignment if countertop is not level.

Weak, unstable floor. Be sure floor is level and can adequately support range. If floor is sagging or sloping, contact a carpenter to correct the situation.

Kitchen cabinet misalignment may make range appear to be unlevel. Be sure cabinets are square and have sufficient room for range clearance.

Cannot move appliance easily.
Appliance must be accessible for service.

Cabinets not square or are built in too tight. Contact a cabinet maker to correct the problem.

Contact builder or installer to make appliance accessible.

Carpet interferes with range. Provide sufficient space so range can be lifted over carpet.

Gas line is hard-plumbed. Have a flexible C.S.A international approved metal appliance connector installed.

Entire range or oven does not operate.

Make sure cord/plug is plugged tightly into outlet.

Service wiring is not complete. Call an authorized servicer.

Electrical power outage. Check house lights to be sure. Call your local electric company for service. Surface burners can be lit manually.

*Oven control beeps and displays any F code error (for example F11)

Electronic control has detected a fault condition. Press **STOP/CLEAR** to clear the display and stop beeping. Reprogram oven. If fault recurs, record fault number. Press **STOP/CLEAR** and call an authorized servicer for assistance.

Oven light does not work.

Replace or tighten bulb. See **Changing Oven Light** section in this Use & Care Guide.

Surface burners do not light.

Surface control knob has not been completely turned to LITE. Push in and turn the surface control knob to LITE until burner ignites and then turn the surface control knob to the desired flame size.

Burner ports are clogged. Clean burners. See "Cleaning the Burner Grates, Burner Caps and Burner Heads" under General Cleaning.

Range power is disconnected from outlet. Be sure cord is securely plugged into the outlet.

Electrical power outage.

Be sure the gas supply to the range is turned "ON".

Surface burner flame burns half way around.

Burner ports or slots are clogged. With the burner off, use a small-gauge wire or needle to clean ports or slots.

Moisture is present after cleaning. Lightly fan the flame and allow the burner to operate until flame is full. Dry the burners thoroughly following instructions under General Cleaning.

Before you call *Solutions to Common Problems*



Surface burner flame is orange.

Dust particles in main line. Allow the burner to operate a few minutes until flame turns blue.

Salt air in coastal areas. A slightly orange flame is unavoidable.

Poor baking results.

Many factors affect baking results. Make sure the proper rack position is used. Center food in the oven and space pans to allow air to circulate. Allow the oven to preheat to the set temperature before placing food in the oven. Try adjusting the recipes' recommended temperature or baking time. If you feel the oven is too hot or cool, see "**Adjusting the Oven Temperature**" section in the Electronic Oven Control Guide.

Fan noise during cooking operation.

A cooling fan may automatically turn on and off to cool internal parts. It is normal, and the fan may continue to run even after oven is turned off.

Flames inside oven or smoking from vent.

Excessive spillovers in oven. Set self-clean cycle for a longer cleaning time.

Excessive spillovers in oven. This is normal, especially for pie spillovers or large amounts of grease on the oven bottom. Wipe up excessive spillovers before starting the self-clean cycle. If flames or excessive smoke are present, stop the self-clean cycle and follow the steps under "**Stopping or Interrupting the Self-Cleaning Cycle**" in the Electronic Oven Control Guide.

Oven smokes excessively during broiling.

Meat is too close to the element. Reposition the rack to provide proper clearance between the meat and the oven boil element.

Meat is not properly prepared. Remove excess fat from meat. Remove remaining fatty edges to prevent the meat from curling, but do not cut into the lean of the meat.

Broiler pan used without the Broiler Pan Insert or insert is covered with foil. DO NOT use a Broiler Pan without the Broiler Pan Insert or cover the insert with foil.

Broiler Pan or Broiler Pan Insert needs to be cleaned. Excessive smoking is caused by buildup of grease or food spatters. Clean your Broiler Pan and Insert on a regular basis.

Oven door is closed. Oven door should be open at the broil stop position when broiling.

Self-cleaning cycle does not work.

Control(s) not set properly. Follow instructions under "**Oven Cleaning**" in the Electronic Oven Control Guide.

Self-cleaning cycle was interrupted. Stop time must be 2 to 4 hours past the start time. Follow steps under "**Stopping or Interrupting the Self-Cleaning Cycle**" in the Electronic Oven Control Guide.

Soil not completely removed after self-cleaning cycle.

Set Self-Clean cycle for a longer cleaning time.

Failure to clean bottom front, top of oven or door areas outside oven seal. These areas are not in the Self-Cleaning area, but get hot enough to burn on food residue. Clean these areas before starting the Self-Clean cycle. Burned-on residue may be cleaned with a stiff nylon brush and water or nylon scrubber. Be careful not to damage the oven gasket.

Excessive smoking from oven vent.

Excessive spillovers in oven, especially for pie spillovers or large amounts of grease on the oven bottom. Wipe up excessive spillovers before starting the Self-Clean cycle. If flames or excessive smoke are present, stop the Self-Clean cycle and follow the steps under "**Stopping or Interrupting the Self-Cleaning Cycle**" in the Electronic Oven Control Guide.



Major Appliance Warranty Information

Your appliance is covered by a one year limited warranty. For one year from your original date of purchase, Electrolux will pay all costs for repairing or replacing any parts of this appliance that prove to be defective in materials or workmanship when such appliance is installed, used and maintained in accordance with the provided instructions.

Exclusions **This warranty does not cover the following:**

1. Products with original serial numbers that have been removed, altered or cannot be readily determined.
2. Product that has been transferred from its original owner to another party or removed outside the USA or Canada.
3. Rust on the interior or exterior of the unit.
4. Products purchased "as-is" are not covered by this warranty.
5. Food loss due to any refrigerator or freezer failures.
6. Products used in a commercial setting.
7. Service calls which do not involve malfunction or defects in materials or workmanship, or for appliances not in ordinary household use or used other than in accordance with the provided instructions.
8. Service calls to correct the installation of your appliance or to instruct you how to use your appliance.
9. Expenses for making the appliance accessible for servicing, such as removal of trim, cupboards, shelves, etc., which are not a part of the appliance when it is shipped from the factory.
10. Service calls to repair or replace appliance light bulbs, air filters, water filters, other consumables, or knobs, handles, or other cosmetic parts.
11. Surcharges including, but not limited to, any after hour, weekend, or holiday service calls, tolls, ferry trip charges, or mileage expense for service calls to remote areas, including the state of Alaska.
12. Damages to the finish of appliance or home incurred during installation, including but not limited to floors, cabinets, walls, etc.
13. Damages caused by: services performed by unauthorized service companies; use of parts other than genuine Electrolux parts or parts obtained from persons other than authorized service companies; or external causes such as abuse, misuse, inadequate power supply, accidents, fires, or acts of God.

DISCLAIMER OF IMPLIED WARRANTIES; LIMITATION OF REMEDIES

CUSTOMER'S SOLE AND EXCLUSIVE REMEDY UNDER THIS LIMITED WARRANTY SHALL BE PRODUCT REPAIR OR REPLACEMENT AS PROVIDED HEREIN. CLAIMS BASED ON IMPLIED WARRANTIES, INCLUDING WARRANTIES OF MERCHANTABILITY OR FITNESS FOR A PARTICULAR PURPOSE, ARE LIMITED TO ONE YEAR OR THE SHORTEST PERIOD ALLOWED BY LAW, BUT NOT LESS THAN ONE YEAR. ELECTROLUX SHALL NOT BE LIABLE FOR CONSEQUENTIAL OR INCIDENTAL DAMAGES SUCH AS PROPERTY DAMAGE AND INCIDENTAL EXPENSES RESULTING FROM ANY BREACH OF THIS WRITTEN LIMITED WARRANTY OR ANY IMPLIED WARRANTY. SOME STATES AND PROVINCES DO NOT ALLOW THE EXCLUSION OR LIMITATION OF INCIDENTAL OR CONSEQUENTIAL DAMAGES, OR LIMITATIONS ON THE DURATION OF IMPLIED WARRANTIES, SO THESE LIMITATIONS OR EXCLUSIONS MAY NOT APPLY TO YOU. THIS WRITTEN WARRANTY GIVES YOU SPECIFIC LEGAL RIGHTS. YOU MAY ALSO HAVE OTHER RIGHTS THAT VARY FROM STATE TO STATE.

If You Need Service

Keep your receipt, delivery slip, or some other appropriate payment record to establish the warranty period should service be required. If service is performed, it is in your best interest to obtain and keep all receipts. Service under this warranty must be obtained by contacting Electrolux at the addresses or phone numbers below.

This warranty only applies in the USA and Canada. In the USA, your appliance is warranted by Electrolux Major Appliances North America, a division of Electrolux Home Products, Inc. In Canada, your appliance is warranted by Electrolux Canada Corp. Electrolux authorizes no person to change or add to any obligations under this warranty. Obligations for service and parts under this warranty must be performed by Electrolux or an authorized service company. Product features or specifications as described or illustrated are subject to change without notice.

USA

1.800.944.9044

Electrolux Major Appliances
North America
P.O. Box 212378
Augusta, GA 30907



Canada

1.800.668.4606

Electrolux Canada Corp.
5855 Terry Fox Way
Mississauga, Ontario, Canada
L5V 3E4