

FREE STANDING, SELF CLEANING

GAS RANGE USE AND CARE MANUAL

**Copy Your Model and Serial Numbers
IN THE BOX BELOW**

Model and Serial Numbers can be found on a tag, behind the storage drawer, on the range front frame. If you call for service, or with a question, have this information ready.

Keep this book, your installation guide, your warranty and the sales slip together.

Model No.: _____

Serial No.: _____

Purchase Date: _____

PART NO. 338979 (4348360)

SAFETY RULES	2-4
BURNER IGNITION	5
HOW TO USE YOUR RANGE	6-10
• Using Cooktop Burners	6
• Energy Saving Tips	6
• Clock and Oven Controls	7, 8
• Oven Light and Panel Light	9
• Oven Vent	9
• New Oven Odor	9
• Moisture	9
• Adjusting Oven Temperature	9
• Rack and Pan Arrangement	10
• Preheating	10
COOKING HINTS	11-14
• Using Foil	11
• Roasting Tips	11
• Using a Meat Thermometer	12
• Positioning Broiler Pan	12
• Broiling Tips	13
• Common Baking Problems and Causes	13
• Choosing Cookware Chart	14
CLEANING AND CARE	15-22
• Oven Cleaning	15-17
• Cleaning Instructions	17
• Replacing Panel Light	18
• Lift Up/Off Cooktop	18
• Removable Cooktop Burners	19
• Removable Oven Door	20
• Removable Oven Bottom	20
• Replacing Oven Light	21
• Removable Oven Racks	21
• Removable Storage Drawer	22
PREVENTING SERVICE CALLS	22, 23

Warranties Are Based On Time, Not Usage.

You should try each feature and control on your new range soon after installation.

FOR YOUR SAFETY

If you smell gas:

1. Open windows
2. Don't touch electrical switches.
3. Extinguish any open flame.
4. Call your gas supplier immediately.

FOR YOUR SAFETY

Do not store or use gasoline or other flammable vapors and liquids in the vicinity of this or any other appliance.

L.P. and Burner Adjustments

The adjustments in your Installation Guide must be made before you try to use your range.

If you are using Liquified Petroleum Gas (bottled gas) all L.P. adjustments in your installation guide must be made before use.

If your range is not properly adjusted, flames may be too high, or the range may use too much fuel, release toxic fumes or cook poorly.

IMPORTANT INSTRUCTIONS

ONLY YOU CAN PREVENT ACCIDENTS! Read the Safety Rules below and all operating instructions before using this appliance.

GENERAL

Keep this book for later use.

Be sure your range is put in and grounded by a skilled technician.

Never try to fix or replace any part of the range unless this book tells you to. All other work should be done by a skilled technician.

Never block free air flow thru the oven vent (see page 9) or to the cooktop burners.

Only some kinds of glass and ceramic pans can be used for cooktop cooking. Be sure that the pan you use will not break when heated on the cooktop burner. See page 14 for tips on cookware.

CHILD SAFETY

Teach your children not to play with range knobs or any other part of the range.

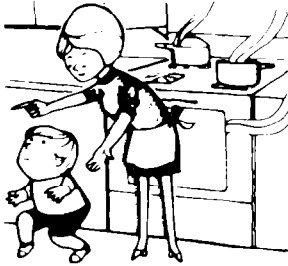

Never leave children alone or unwatched where a range is in use.

Never let children sit or stand on the cooktop or open oven door. The child's weight may make the range tip over.

Never leave the oven door open when you are not watching the range.

Caution — Do not store things children might want above a range. Never let children climb on any part of the range.



NO!

SAFETY

Never use your range to heat a room. Doing so can be dangerous and hurt range parts.

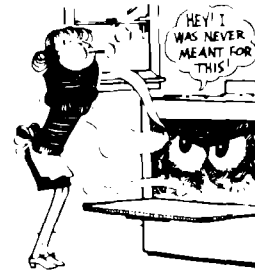

NO!

Never wear loose or hanging clothes while using your range. Such clothes could catch fire.

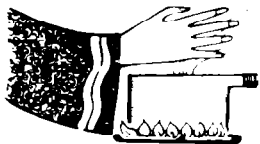

NO!

Never heat unopened food containers. Pressure build-up may make container burst and cause injury.

Never let pot handles stick out over the front of the range. Turn handles in, over the cooktop, so that they cannot be bumped into. Be sure not to turn handles over another burner. They may get hot and burn you.

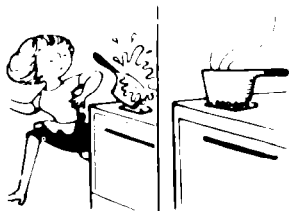

NO!

Always use care when opening the oven door. Let hot air or steam out before moving food.

Always move oven racks while oven is cool.

Always use dry potholders when removing pans from the oven or cooktop. Moist or damp potholders can cause steam burns. Do not use a towel or other bulky cloth.



NO!

GREASE FIRES

Never leave cooktop burners unwatched at high heat settings. Boilovers cause smoking and greasy spillovers may catch fire.



NO!

Always keep the range area clear and free from things that could catch fire, gasoline and other flammable vapors and liquids. Never store things in an oven or near cooktop burners. These things may catch fire and plastic items may melt and burn.

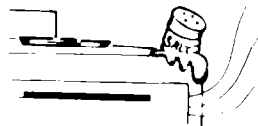

NO!

Never use aluminum foil to line drip bowls (under burner grate) or oven bottoms. Only use foil as shown on page 11 of this book. Improper use of foil can start a fire or keep all the gas from burning.

Never leave jars or cans of fat or drippings on or near the range. Never let grease build up on your range. You can keep grease fire from starting if you clean up grease and spillovers after each range use.

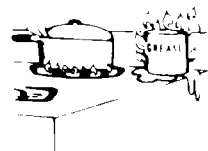

NO!

PUTTING OUT A GREASE FIRE

A dry chemical, foam or Halon type fire extinguisher should be near the range where you can easily reach it in case of a cooking fire. A Halon extinguisher will not spoil the food and makes no mess.

Never use water on a grease fire — it will only spread the flames. Never pick up a flaming pan. Instead,

1. Turn off the burner.
2. Smother the fire with a tightly fitting pan lid, baking soda or an extinguisher.

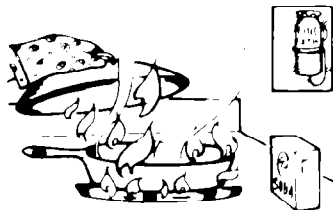

How to put out a liquid grease fire with a fire extinguisher:

1. Stand back 5 or 6 feet.
2. Open the extinguisher.
3. Starting at the flames closest to you, move the extinguisher side to side and work back until all flames are out.

CAUTION: If you bring the extinguisher too close you may blow burning grease all over the cooking area.

SELF-CLEANING OVEN

Always take the oven racks, the broiler pan and other pots and pans out of the oven before a self clean cycle. Do not try to clean cookware, removable parts of the range or any other utensils in the oven during a self clean cycle. Clean only range parts listed in this book. See pages 15-21.

Never use any kind of oven cleaner or oven liner coating on any part of your range. Do not use any spray cans near your range. The gas used to make these cans spray can cause rusting of metal parts in areas of high heat.



NO!

The door gasket is needed for a good seal. Do not rub the gasket. Clean only with hydrogen peroxide. See page 15.

SPARK COOKTOP IGNITION

When you turn the control knob to LITE, the igniter makes an electric spark (ticking sound) which lights the burner.

TO MANUALLY LIGHT COOKTOP BURNERS WITH SPARK IGNITION

CAUTION

Lighting gas burners with a match is dangerous. The flames can burn you or a buildup of gas can explode. You should match light the cooktop burners only in an emergency.

During a power failure the burners will not light automatically. In an emergency, a cooktop burner may be lit with a match by following the steps below.

1. Be sure there is no pan on the burner you are lighting.
2. Light a match and hold the match flame near the burner you want to light. Wooden matches work the best.

3. Push in and turn the control knob slowly. Be sure you are turning the correct knob for the burner you are lighting.

Note: If the burner does not light within five seconds, turn the knob off and wait one minute before trying again.

GLOW BAR OVEN/BROILER IGNITION

When you turn the Oven Control knob on, the glow bar igniter begins to heat. When the igniter is hot enough, in about one minute, the gas flows into the burner and is ignited.

The igniter glows bright orange when hot. It goes on and off with the thermostat and will glow whenever the burner is on.

CAUTION

During a power failure the oven burner and broiler cannot be lit and you should not try to do so.

USING COOKTOP BURNERS

A sign near each cooktop control knob shows which burner is turned on by that knob. For example, When you turn the knob nearest to  , the right front burner will light.

Some models have a cone-shaped cooktop burner, with a circular opening through the center of the burner, at the right front or both front cooktop positions. These "All-Purpose Burners" can provide one third again as much heat as the other burners. Use the "All-Purpose Burners" for cooking large amounts of food in a big pan, canning, etc. See additional information on page 19.

CAUTION

Set controls so flame heats pan bottom only and does not lick pan sides. Flames licking pan sides are unsafe and waste gas.

When you turn a control knob to LITE, the burner is lit by a series of electric sparks (ticking sound) from the igniter.

To light a burner:

1. Be sure there is no pan on the burner you are lighting.
2. Push the control knob in and turn it left to light.

3. When the burner lights, turn the knob to set the flame size.

IMPORTANT: Do not leave the control knob on LITE after the burner is lit, or the life of the spark igniter may be shortened.

IF A BURNER DOES NOT LIGHT

If a burner fails to light within five seconds, turn the knob to OFF and wait one minute before trying again.

If the burner still will not light, check Preventing Service Calls on pages 22 and 23.

ENERGY SAVING TIPS

- Be sure the burners (and pilots, if applicable) are properly adjusted when your range is installed. Adjustment information is in your Installation Guide.
- Clean all burners often (see pages 17 and 19). Dirty burners reduce efficiency.
- When possible, thaw frozen foods before cooking, cook with the minimum amount of water and use a pan with a tightly fitting lid.
- Adjust the flame to fit the size of the pan.
- Be sure to watch foods when heating them quickly on HI. As soon as the food reaches the cooking temperature, turn down the heat to the lowest setting that will keep it cooking.

CLOCK AND OVEN CONTROLS

The oven of your new range is entirely controlled by the Electronic Range Control. Follow instructions below.



TO SET THE CLOCK

1. Push CLOCK button.
2. Turn SET knob to correct time of day. Clock is now set.

Note: To display the time of day during timed baking, push the CLOCK button. This will show the time but will not cancel any oven operation.

TO SET THE TIMER:

1. Push TIMER button.
2. Turn SET knob to desired amount of time. The Timer will immediately begin to count down.
3. When time is up, the end of cycle tone will sound.
4. To cancel the Timer, push and hold TIMER button for three seconds. This will clear the TIMER function. If the "Timer time" was being displayed, the display will go to the time of day. If the "Timer time" was not being displayed, the display will not change.

Note: The Timer is a reminder only and will not operate the oven. You can use the Timer whether or not the oven is being used. The Timer does not interfere with oven operations.

TO BAKE:

1. Push BAKE button.

2. Turn SET knob until desired temperature is displayed. The oven begins to heat within two seconds, and the display will show the temperature as it rises (in 5F° steps).
3. The Notification Tone will sound when the oven has stabilized at the selected temperature. The display will show this temperature before the tone.
4. When finished baking, push the OVEN CANCEL button.

Note: To recall what temperature you have selected while the rising temperature is being shown, push and hold the BAKE button. The selected temperature will be shown while you hold the BAKE button and will return to actual oven temperature when you release the BAKE button. You can change the selected temperature at any time by pushing the BAKE button and turning the SET knob.

TO BROIL:

1. Push BROIL button.
2. Turn SET knob until HI or LO Broil is visible in the display (see page 12).
3. When finished broiling, push the OVEN CANCEL button.

TO USE TIMED OVEN/DELAY START

Put the food in the oven and program your Electronic Range Control to turn the oven on and off. Follow instructions below and on next page.

CAUTION

Never let food sit for more than 4 hours before cooking starts, when you set your oven for a delay start. Room temperature is ideal for the growth of harmful bacteria. Be sure oven light is off because heat from the bulb will speed bacteria growth.

Note: To cancel any timed oven operation, push the OVEN CANCEL button.

OVEN LIGHT AND PANEL LIGHT (Some Models)

To turn the oven light on and off, push the Oven Light switch on the control panel. See page 21 for additional information.

Some models have a fluorescent panel light. Turn this light on and off with the panel light switch on the backguard. See page 18 for more information.

OVEN VENT

When the oven is on, heated air moves through a vent in or below the backguard. On the cooktop, this hot air may make pot handles hot or melt plastic things left too near the vent.

The vent is needed for proper air flow in the oven and good baking results. **Do not block this vent. Doing so may cause cooking failure, fire or damage to the range.**

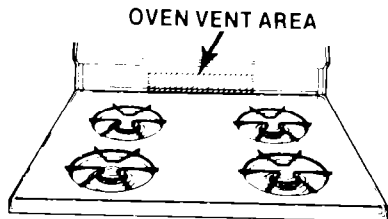

FOLDING OVEN RACK (Some Models)

Some models have one folding oven rack. This enables you to easily store away one of the racks. It is recommended that you use the folding rack in the lower position when using both racks.

NEW OVEN ODOR

During the first baking and broiling cycles in your oven, there may be some odor. This is normal and is caused by the heating of new parts and insulation. The odor will go away within a short time. A vent fan or other ventilation will help to clear the air.

MOISTURE

As your oven heats up, the heat mixing with the cooler air in the oven may cause water droplets on the door or door glass. To prevent this, open the oven door for the first minute of oven heat up to let the moist air out.

ADJUSTING OVEN TEMPERATURE

The temperature in your new oven has been set correctly at the factory, so be sure to follow the recipe temperatures and times the first few times you bake in your new oven.

If you think the oven should be hotter or cooler, you can adjust the temperature yourself. To decide how much to change the temperature, set the temperature 25F° higher or lower than the temperature in your recipe, then bake. The result of this "test" should give you an idea of how much the temperature should be changed.

TO ADJUST THE TEMPERATURE:

1. Push the BAKE button
2. Select a temperature between 500°F and 550°F with the SET knob.
3. Quickly (within two seconds, before the BAKE function energizes) push and hold the BAKE button. The display will change to the amount of degrees difference between the original factory temperature setting and the current temperature setting. If the oven temperature has never been adjusted, the display will read 00.
4. Turn the SET knob to adjust oven temperature. The temperature can be adjusted up to 35F° hotter or 35F° cooler, in 5F° steps. A minus sign(—) before the number means that the oven will be cooler by displayed amount of degrees.
5. When you have made the desired adjustment, push any button to go back to the time of day display or use your oven as you would normally.

Note: The self clean cycle temperature will not be changed by the adjustments described above.

OVEN LIGHT AND PANEL LIGHT (Some Models)

To turn the oven light on and off, push the Oven Light switch on the control panel. See page 21 for additional information.

Some models have a fluorescent panel light. Turn this light on and off with the panel light switch on the backguard. See page 18 for more information.

OVEN VENT

When the oven is on, heated air moves through a vent in or below the backguard. On the cooktop, this hot air may make pot handles hot or melt plastic things left too near the vent.

The vent is needed for proper air flow in the oven and good baking results. **Do not block this vent. Doing so may cause cooking failure, fire or damage to the range.**

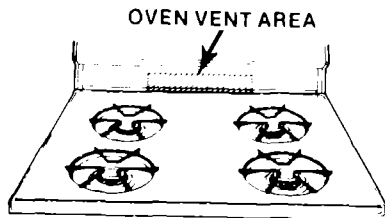

FOLDING OVEN RACK (Some Models)

Some models have one folding oven rack. This enables you to easily store away one of the racks. It is recommended that you use the folding rack in the lower position when using both racks.

NEW OVEN ODOR

During the first baking and broiling cycles in your oven, there may be some odor. This is normal and is caused by the heating of new parts and insulation. The odor will go away within a short time. A vent fan or other ventilation will help to clear the air.

MOISTURE

As your oven heats up, the heat mixing with the cooler air in the oven may cause water droplets on the door or door glass. To prevent this, open the oven door for the first minute of oven heat up to let the moist air out.

ADJUSTING OVEN TEMPERATURE

The temperature in your new oven has been set correctly at the factory, so be sure to follow the recipe temperatures and times the first few times you bake in your new oven.

If you think the oven should be hotter or cooler, you can adjust the temperature yourself. To decide how much to change the temperature, set the temperature 25F° higher or lower than the temperature in your recipe, then bake. The result of this "test" should give you an idea of how much the temperature should be changed.

TO ADJUST THE TEMPERATURE:

1. Push the BAKE button
2. Select a temperature between 500°F and 550°F with the SET knob.
3. Quickly (within two seconds, before the BAKE function energizes) push and hold the BAKE button. The display will change to the amount of degrees difference between the original factory temperature setting and the current temperature setting. If the oven temperature has never been adjusted, the display will read 00.
4. Turn the SET knob to adjust oven temperature. The temperature can be adjusted up to 35F° hotter or 35F° cooler, in 5F° steps. A minus sign(—) before the number means that the oven will be cooler by displayed amount of degrees.
5. When you have made the desired adjustment, push any button to go back to the time of day display or use your oven as you would normally.

Note: The self clean cycle temperature will not be changed by the adjustments described above.

RACK AND PAN ARRANGEMENT

Put oven rack(s) in place before turning on the oven. Rack positions are numbered 1 to 4, starting at the bottom with number 1. In general, when using only one rack, position No. 2 should be used. When using two racks, positions No. 2 and 4 work best.

When using cookie sheets, place them with the long side toward the front of the oven and centered on the rack. When using two cookie sheets at the same time

use rack positions No. 2 and 4. The cookies on the lower rack may be done 1 - 2 minutes before the ones on the higher rack. You may want to switch rack positions when baking is half way finished.

Pans too close to each other, to oven walls or to the oven bottom block the free movement of air. Improper air movement causes uneven browning and cooking.

There should be 1½ to 2 inches of air space on all sides of each pan in the oven. See tips on this page.

When using a large flat pan that covers most of the rack, center on one rack.

When baking a sponge or angel food cake, center on one rack in the lowest position.

The pan or pans using the least amount of rack area should be placed on lowest of the two racks.

When using two racks and several pans, stagger them so no pan is directly above another.

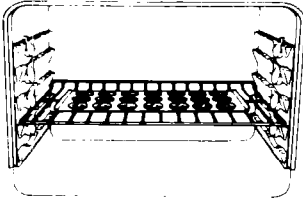

Sheet Cake, Cookies,
Biscuits

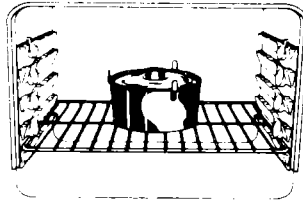

Angel Food or
Sponge Cake

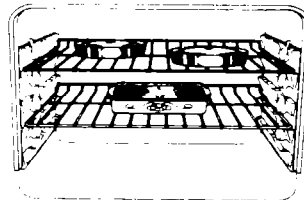

Cake Layers, Pies,
Casseroles, 3 Pans

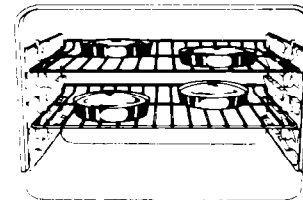

Cake Layers, Pies,
4 Pans (staggered)

PREHEATING

Preheating lets the oven heat evenly before the food is put in. Allow about 10 minutes at temperatures less than 350° F and about 15 minutes at 350° F or more.

With recipes that call for an oven preheated to a certain temperature, it is very important that you follow those instructions. It is not likely that you will get good baking results every time without preheating to the needed temperature, unless the recipe says to start in a cold oven.

After the oven is preheated and you are ready to put the food in, try to have every thing handy so that you will not

have to leave the oven door open for an extended period of time.

Opening the door often to check the food during baking makes it impossible for the oven to stay at the temperature you have selected. Try to time your baking and check only when close to being finished.

Note: When using cookware made of oven proof glass or pottery, Teflon coated cookware and dull or darkened pans in the oven, be sure to reduce recipe temperature by 25° F (see choosing Cookware Chart, page 14).

USING FOIL

For Baking

To catch spillovers, cut a piece of foil slightly larger than the pan and turn up the edges. Use two oven racks and put the foil on the lower oven rack below the pan. Do not use aluminum foil directly under a pan on the same oven rack. The foil will reflect heat away from the pan.

CAUTION

Do not cover the oven bottom or an entire oven rack with foil. The foil can block normal heat flow, cause cooking failures and damage the oven interior.

For Roasting

For slow browning, place a foil "tent" loosely over the meat. This is especially good on a large turkey. Do not seal the foil. Sealing the foil will tend to steam the meat.

To reduce spattering, lightly crush foil and put it in the bottom of the pan under the food.

For Broiling

CAUTION

Do not cover the broiler grid with foil. Hot fat on the foil may cause a broiler fire. If a fire starts, close the oven door and turn controls off. If fire does not go out, throw baking soda on fire. Do not put water on the fire.

ROASTING TIPS

- Roasting time will depend on the oven temperature, meat temperature, size, shape and type of the meat, the proportion of bone and fat, and the degree of doneness (internal temperature) you desire.
- Add extra time (15 to 20 minutes per pound) when roasting frozen meats.
- For even cooking, all poultry must be completely thawed before roasting.
- For self-basting, put meat in pan with the fat side up.
- Use a roasting pan that fits the size of the roast. Too small a pan will let melted fat drip over the edge and too large a pan will cause spattering.
- Reduce spattering by putting lightly crushed foil in the pan under the food.
- To best measure doneness, always use a meat thermometer.
- For easier carving, let the roast stand 10 to 20 minutes after removing it from the oven. Always carve across the grain of the meat.

MEAT	OVEN TEMP	INTERNAL TEMP
Beef, Lamb rare medium well	325° F	140° F 160° F 170° F
Veal, Fresh Pork	325° F	170° F
Chicken	375° F	190° F
Turkey	325° F	185° F

USING A MEAT THERMOMETER

Stick the thermometer into the center of the largest muscle of meat, or in the inner thigh or breast of poultry. For an accurate reading, the tip of the thermometer should not touch bone or gristle or rest in a pocket of fat.

As the meat cooks, the thermometer may slip from its position. If the reading on the thermometer seems unusually high for the length of time the meat has cooked, check the thermometer and reposition it if necessary.

If you let a roast stand 10 to 20 minutes after you remove it from the oven, it will be easier to carve and the internal temperature will raise as it stands. Remove the roast from the oven when the thermometer reads 5° F to 10° F less than the internal temperature you desire. If you do not plan to let the roast stand, leave the meat in the oven until the full temperature is reached.

POSITIONING BROILER PAN

Broiling is cooking by direct heat from the upper oven burner. Tender cuts of meat or marinated meat should be selected for broiling. For best results, steaks and chops should be at least $\frac{3}{4}$ " thick.

After placing food on the broiler pan, put the pan on an oven rack in the proper rack position. See the chart at right for recommended rack position and cooking time.

Most foods can be broiled on the HI Broil setting. Select the LO Broil setting to avoid excessive browning of foods that should be cooked to the well done stage (such as pork chops or poultry).

The closer the food is to the broiler burner the faster the meat browns on the outside, yet stays red to pink in the center. Moving the meat farther away from the burner lets the meat cook to the center while browning outside.

Food	Rack Position 4 = Highest 1 = Lowest	Total Time (Minutes)
Steak - 1" Thick		
Rare	4	10-12
Medium	3	14-16
Well Done	3	20-22
Ground Beef Patties		
Medium	3	11-13
Well Done	3	13-15
Lamb Chops - 1" Thick	3	16-20
Pork Chops - 1" Thick	3	20-25
Pork Shoulder Steaks	3	15-20
Ham Slice - 1" Thick	3	14-16
Fish (Fillets)	3	10-15
Chicken (Halves)	1	40-60
Frankfurters	3	10-15
Bacon	3	5-7
Open-face Sandwiches	2	6-10

This chart is a general guide. The size, weight, thickness and starting temperature of the food, as well as your own personal preference, will effect the desired cooking.

BROILING TIPS

- Your oven door should be completely closed while broiling.
- Use only the broiler pan and grid that came with your range for broiling. They are made for proper drainage of fat and liquids and help prevent spatter, smoke or fire.
- Do not preheat when broiling. For even broiling on both sides, start the food on a cold pan. Allow slightly more than half the cooking time for the first side then turn the food using tongs. If you pierce the meat with a fork, the juices will escape.
- When broiling frozen meat, use one rack position lower than shown in the chart and up to 1½ times the broiling time.
- Trim the outer layer of fat from steaks and chops. Slit the fatty edges to keep the meat from curling.
- Always put the food being broiled on the proper rack (see chart at right). Food placed too close to the broiler may spatter, smoke or catch fire.
- For maximum juiciness, salt the first side just before turning the meat. Salt the second side just before serving.
- Brush chicken and fish with butter several times as they broil. When broiling fish, grease the grid to prevent sticking.
- Never leave a soiled broiler pan in the range. Grease in the pan may smoke or burn the next time the oven is used. See page 13 for tips on cleaning the broiler pan and grid.
- Be sure you know how to put out a grease fire. See page 4.

COMMON BAKING PROBLEMS & CAUSES

CAKE RISES UNEVENLY

- Range or oven rack not level
- Pan warped
- Batter spread unevenly in pan
- Pans too close to oven wall or rack too crowded

CAKE HIGH IN MIDDLE

- Too much flour
- Oven temperature too high

CAKE NOT DONE IN CENTER

- Wrong pan size
- Oven too hot
- Pan not centered on oven

CAKE FALLS

- Too much shortening, liquid or sugar
- Temperature too low
- Pan too small
- Oven door opened too often
- Too much leavening or stale leavening
- Overmixing after adding flour

BOTTOM PIE CRUST SOGGY

- Filling too juicy
- Filling allowed to stand in pie shell before baking
- Used shiny pans
- Temperature too low at start of baking
- Crust and/or filling not allowed to cool before filling crust

BURNING AROUND EDGES OF PIE CRUST

- Oven temperature too high
- Edges of crust too thin or too high
- Oven too full or pans too close together

COOKIES AND BISCUITS BURN ON THE BOTTOM

- Oven preheat time too short
- Pan too deep or too large
- Used dark pans
- Used wrong rack position

FOOD NOT DONE AT END OF COOKING TIME

- Oven temperature set too low
- Oven too crowded
- Oven door opened too often
- Aluminum foil blocking air movement

CHOOSING COOKWARE

COOKTOP COOKWARE	COOKING NOTES
Aluminum	Spreads heat quickly and evenly. Best for frying, braising and pot roasts.
Cast iron	Slow to change temperature and holds heat. Good for browning, frying and stewing.
Copper, Tin-lined	Quick to change temperature. Great for gourmet cooking, wine sauces and egg cookery. Tinning will wear thin with use and must be retinned to avoid a poisonous reaction between the copper, the heat and the food.
Glass Ceramic	Slow to change temperature. Best for long, low heat cooking with a liquid.
Porcelain Enamel	Porcelain enamel over steel is long lasting, stain and scratch resistant. How well it heats depends upon the type of steel used. Best for cooking soups and other liquids.
Stainless Steel	Usually combined with other metals such as aluminum, copper or carbon steel. These other metals make the cookware heat more quickly while the stainless steel makes it strong and long lasting. Best for frying, sauces, soups, vegetables and egg cooking.
OVEN COOKWARE	
Aluminum	Absorbs heat faster than glass or steel and conducts heat well. Gives delicate browning, tender crusts, and reduces spattering of roasts. Best for cakes, muffins, quick breads, cookies and roasting.
Ovenproof Glass/ Pottery	Because this cookware absorbs and holds heat well, you should lower your oven temperature 25° F. Gives food a deep, crusty brown top. Best for casseroles.
Teflon, Dull or Darkened Cookware	Absorbs heat quicker than shiny cookware. Lower your oven temperature 25° F (except for pastry). Good for pies and other foods baked in pastry shells.

Q. Can I use special cookware, like an oriental wok, on my cooktop burners?

A. Some oriental woks have support rings that block the

free air flow that is needed for proper operation of the burner. Also, the trapping of high heat around the burner may damage the cooktop. You should not use utensils which go below the top of the cooktop burner grate.

OVEN CLEANING

1. Take out the broiler pan and grid, oven racks, all utensils and any foil that may be in the oven. If oven racks are left in the range during a clean cycle, they will darken, lose their shine and become hard to slide. If you wish to leave the racks in the oven during the self-clean cycle you can make them slide easier afterwards if you put a little vegetable oil on the edges of the rack.
2. Soil on the oven front, the door liner, outside the door seal and the front edge of the oven cavity (about 1" into the oven) will not be cleaned during a clean cycle (see illustration at right). Clean these areas by hand before starting a clean cycle.

Use detergent and hot water with a soap-filled steel wool pad, then rinse well with a vinegar and water mixture. This will help prevent a brown film from forming when the oven is heated.

3. Wipe up heavy spillovers on the oven bottom. Too much soil may cause smoking during the clean cycle.
4. Clean the door seal by using a clean sponge to soak the soiled area with hydrogen peroxide. Repeated soaking may be needed depending on the amount of soil. Cleaning often will prevent soil build up. Do not rub the door seal. The fiberglass material of the seal has a very low resistance to abrasion (rubbing). Any cotton material especially (including cottonballs), can easily rub a hole into the seal. Do not use any cotton materials to clean the seal. An intact and well fitting oven door seal is needed for energy efficient oven operation and good baking results. If you notice the seal becoming worn, frayed or damaged in any way or if it has become displaced on the door you should replace the seal.

DO NOT use oven cleaners or oven protectors in or near the oven. These products plus the high temperature of the clean cycle may damage the porcelain finish.

DO NOT clean glass ceramic cookware or any other cookware in the oven during a self-clean cycle.

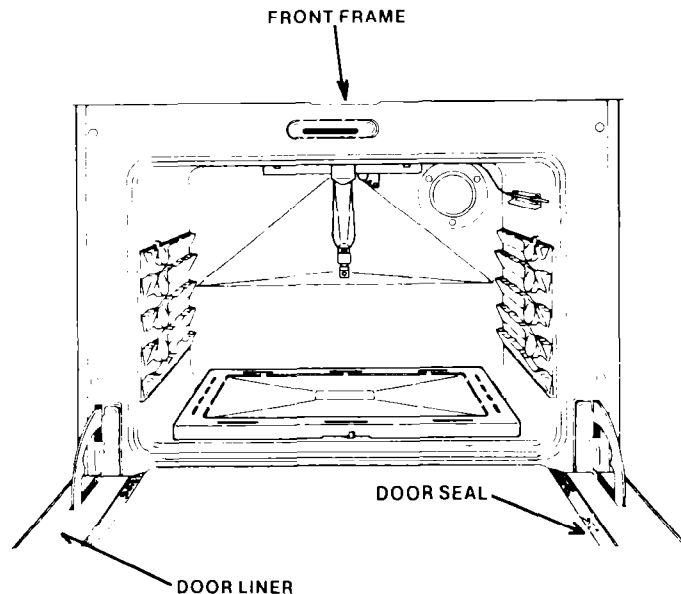

After a cleaning cycle, the oven door cannot be unlocked until the temperature has had time to drop to a safe level and the word LOCK is off in the display (20 - 30 minutes).

IMPORTANT INFORMATION

To help you understand how the clean cycle works, the stages of the cycle are noted below. See the next page for step by step instructions on setting a clean cycle.

1. The door lock/unlock handle is moved right into the lock position and the controls are set.
2. The oven begins to heat.
3. For your safety, when the locking temperature is reached, the oven door cannot be opened (the word LOCK will be on in the display).
4. When the 3½ hour clean cycle is over, the oven begins to cool.
5. When the temperature has fallen below locking temperature, about 20 - 30 minutes after the oven goes off at the end of the clean cycle, the door can be opened (the word LOCK will be off in the display).

TO SET A CLEAN CYCLE

The self-clean cycle is preprogrammed for 3½ hours. You can also set the electronic range control for a delayed start of the clean cycle.



To self-clean:

1. Slide the door lock handle to the right. You may need to press the door slightly to get it to lock properly. Never try to force the door lock handle. Forcing the handle may damage the door locking mechanism.

2. Push CLEAN button. The oven immediately begins to heat.

Note: You can find out when the clean cycle will be finished by pushing the STOP TIME button.

To use delayed self-clean:

1. Push STOP TIME button.
2. Turn SET knob to time of day when you wish cleaning to be completed (must be more than 3½ hours later than current time of day).
3. Slide the door lock handle to the right. You may need to press the door slightly to get it to lock properly. Never try to force the door lock handle. Forcing the handle may damage the door locking mechanism.
4. Push CLEAN button.

Note: During a delayed self-clean cycle, you can find out when oven will turn on by pushing and holding the CLEAN button.

WHEN CLEAN CYCLE IS FINISHED

1. Wait until the oven has cooled below locking temperature and the word LOCK is off in the display (20-30 minutes).
2. Slide the door lock handle left to unlock the door. You will not be able to unlock the oven unless the oven temperature is at a safe level. Never force the door lock handle.

Note: If the door does not unlock because the temperature has not had time to drop to a safe level when you first try to open the door, be sure to slide the handle back all the way to the right.

Note: To stop a clean cycle at any time, press the OVEN/CANCEL button and follow instructions from WHEN CLEAN CYCLE IS FINISHED.

AFTER A CLEAN CYCLE

After a clean cycle, you may notice some white ash in the oven. Just wipe it up with a damp cloth.

If white spots still remain, remove them with a soap-filled steel wool pad. Be sure to rinse thoroughly with a vinegar and water mixture. These deposits are usually a salt residue that cannot be removed by the clean cycle.

If the oven is not clean after one clean cycle, the cycle may be repeated.

CLEANING INSTRUCTIONS

BACKGUARD, CONTROL PANEL AND KNOBS:

Pull knobs off and wash in sink with **soap and water**. Wash backguard and control panel with soap and water, rinse with **vinegar and water** and dry with a paper towel.

COOKTOP BURNERS:

Wash with **soap and water** and a **non-metal scouring pad**. To clean stubborn soil, remove burners (see instructions on page 19). Fill a non-aluminum pan with water to cover the burner head. Boil water, then slowly add 2 tbsp. of dry **Dip-It granules** (available at most supermarkets) per quart. Add burner with head down and boil 20 minutes. Remove burner and rinse. Wipe any remaining soil off with a cloth or soft brush. Drain out water and heat burners in a warm oven (200° F.) for about ½ hour to dry completely. After cleaning or a spillover, light the burners and make sure no ports are clogged (see page 19). **Do not use all-purpose cleaners, ammonia, powder cleansers or oven cleaners. They can scratch or discolor aluminum.**

BURNER BOX (Under Cooktop):

Raise or remove cooktop as shown on page 18. Wash with **soap and water**, then dry.

CHROME (some cooktops, parts of backguard, drip bowls, trim):

Wash with **soap and water**. For heavy soil, cover with a damp cloth and let soak for 30 minutes. A **chrome cleaner** may be used. To remove fingerprints on brushed chrome, apply a little baby oil with a cloth or paper towel. Rub in the same direction as the brush marks on the chrome.

GLASS (oven door):

Wash with a **soapy cloth**, well wrung out. Remove stubborn soil with a **paste of baking soda and water** or **ammonia and water**. **Do not use abrasive materials. Before using an all-purpose cleaner, check the label to be sure it is recommended for glass—some will permanently damage glass.** To help prevent a brown film from forming on the oven window the next time the oven is heated, rinse the inside of the window with **vinegar and water**, then dry.

PAINT (range sides, lower panel):

Wash with **soap and water** then rinse with **vinegar and water** and dry with a paper towel. **Avoid cleaning powders and abrasives which may scratch the surface.**

PORCELAIN (some cooktops, burner grates):

Porcelain enamel can crack or chip with misuse. It can stain if acid spillovers are not cleaned up quickly. Wash with **soap and water**. For heavy soil, cover with a damp cloth and let soak for 30 minutes or use a **plastic or nylon scouring pad**. Rinse with **vinegar and water** and dry with a paper towel. **If you are not sure if a surface is paint or porcelain, follow the instructions in the paint section above.**

VINYL (some oven handles):

Wash with **soap and water** then dry. **Do not use abrasive or caustic cleaners.**

OVEN FINISH—SELF-CLEANING:

Use **soap, water and a scouring pad** for touch up cleaning between self-cleaning cycles. To keep a brown film from forming when the oven is heated rinse very well with **vinegar and water**. **Avoid any contact with the oven door seal. Never use any oven cleaners.**

OVEN DOOR SEAL:

See instructions on page 15.

OVEN RACKS:

Remove from oven (see instructions on page 21) and wash with **soap and water and a scouring pad**.

BROILER PAN AND GRID:

Do not leave in range to cool. If you clean right away, the soil will steam loose while you are eating. Remove pan from broiler and remove fat drippings. Sprinkle pan with **detergent** then cover with a wet cloth or paper towel and let soak. Later wash in **soap and water** using a **scouring pad** as necessary. Both pan and grid are dishwasher safe.

REPLACING PANEL LIGHT

Do not touch the bulb when it is hot or with wet hands. Never wipe light area with a wet cloth. Interrupt electrical supply before removing.

To Replace Bulb:

1. Remove canopy by pulling it up and off the backguard.
2. Remove bulb. Replace the bulb with one of the same length and wattage.
3. Replace canopy.

To Replace Starter:

1. Remove canopy and bulb as explained above.
2. Grasp starter, turn it counterclockwise, about one quarter turn and lift out. Replace with one of the same wattage.
3. Reposition bulb and canopy.

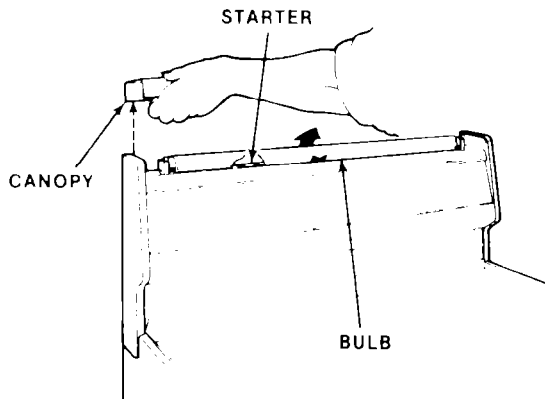

LIFT UP/OFF COOKTOP

The cooktop can be raised or removed so the area under it can be cleaned.

To Raise Cooktop:

1. Remove the burner grates.
2. Raise the front of the cooktop unit until the support rods snap into position to hold cooktop.
3. When finished, carefully lower cooktop into place while pushing in on the front of the support rods.

To Remove Cooktop:

1. Remove the burner grates.
2. Grasp the cooktop and lift the front a little.
3. Grasping the cooktop at the sides, hold it nearly flat while you lift it up and off the back hinges. Unhook the bottoms of the support rods from the range.

See the cleaning instructions on page 17. When finished cleaning, carefully lower cooktop into place, pushing in on the front of the support rods.

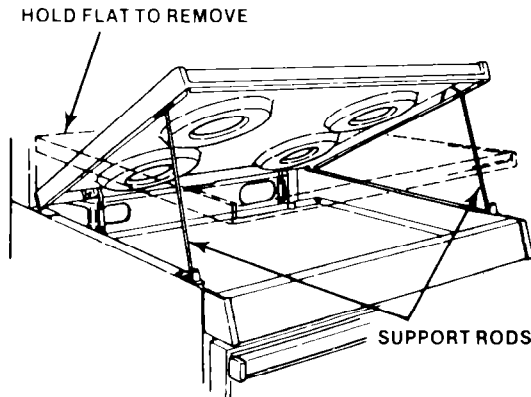

REMOVABLE COOKTOP BURNERS

The cooktop burners on your range may be removed for cleaning. **Be sure all cooktop knobs are turned to off and burners are cool**, then remove or raise the cooktop.

Your range has two types of burners. One type of burner has a solid top and is used at the two rear cooktop positions and at the left front cooktop position of some models.

The second type of burner is cone-shaped and has a circular opening through the center of the burner head. This All-Purpose burner is used at the right front cooktop position or at both front cooktop positions of some models.

Do not try to use the burners in any other position. Damage to your range may result if the smaller burners are used in the All-Purpose burner positions.

If shipping screws were not removed from the burner when the range was installed, do so now (see your Installation Guide for instructions). These screws may be discarded.

To Remove Burners:

1. Grasp the burner head and tilt it to the right to release the two tabs from the burner support (A in Fig. A).

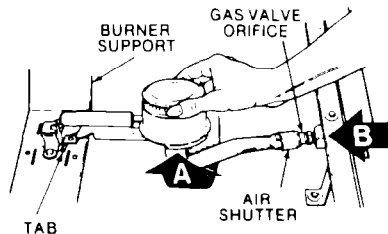

Fig. A

2. Lift the end of the burner assembly, then pull away from the front of the range to free the air shutter from the gas valve orifice (B in Fig. A).

Check lighter and burner ports (Fig. B). If they are clogged, use a wire or needle to clear them.

See the Cleaning instructions on page 17. **Be careful not to disturb the air shutter setting while cleaning.** If you need to readjust the air shutter, see your Installation Guide.

To Replace Burners:

1. Slip the air shutter over the gas valve orifice (Fig. A).
2. Lower the burner assembly and hook the tab in the slots in the burner support (Fig. A).
3. Be sure both tabs are in their slots, that the burner sits level and straight and that the flash tube forms a straight line from the igniter to the burner (Fig. B).

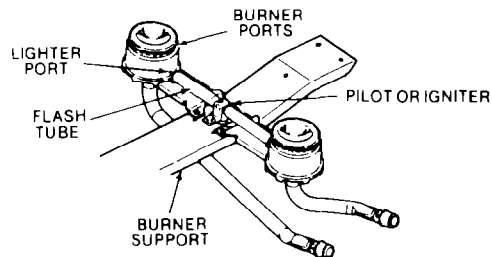

Fig. B

REMOVABLE OVEN DOOR

The oven door may be removed for easier cleaning.

To Remove:

1. Open the door to the stop position (see illustration).
2. Grasp the door at each side and lift up and off the hinges.

See Cleaning Instructions on page 17.

Note: When the door is removed and hinge arms are at stop position, do not bump or try to move the hinge arms. The hinge arms could snap back causing an injury to the hands or damage to the porcelain on the front of the range. You may wish to cover the hinges with towelings or empty towel rolls while working in the oven area.

To Replace:

1. Hold the door over the hinges with the slots at the bottom edge of the door lined up with the hinges. The hinge arm must still be in the stop position.
2. Slide the door down onto the hinges as far as it will go and close the door.

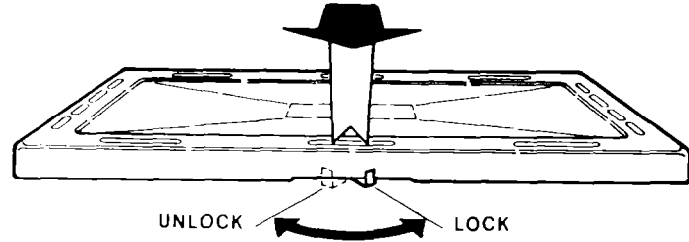
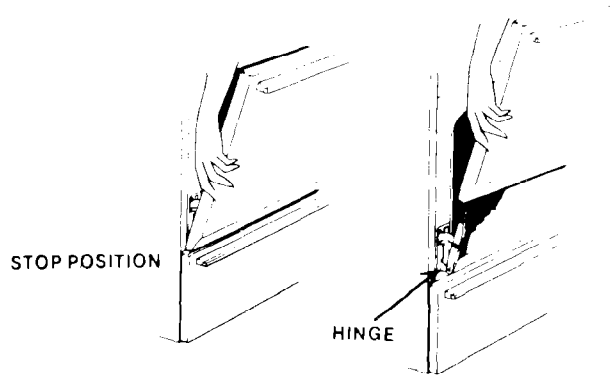

REMOVABLE OVEN BOTTOM

The oven bottom may be removed for cleaning heavy spillovers or to reach the oven burner.

Be careful not to scratch the oven finish when removing or replacing the oven bottom.

To Remove:

1. Slide the tab at the center front of the oven bottom to the left.
2. Lift the oven bottom up and out.

See Cleaning Instructions on page 17.

To Replace:

1. Slip the oven bottom into the oven so the tabs in the rear of the oven bottom fits into the slots in the oven back.
2. Lower the front of the oven bottom into place and slide the tab at the front right to lock the oven bottom into place.

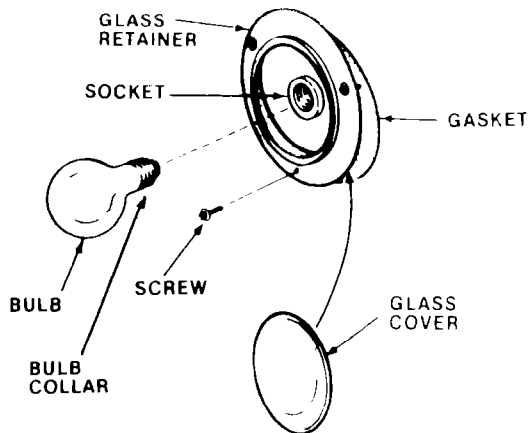

REPLACING THE OVEN LIGHT

Do not touch oven bulb when hot, with wet hands, or wipe oven light area with wet cloth. Unplug or disconnect the electrical supply to range before removing.

Never touch the electrically live collar on the bulb when replacing it.

Electrical power must be shut off if you have to replace a broken bulb.

1. Remove the three screws and lift off the glass retainer, glass cover and gasket.
2. Replace the bulb with a 40 watt appliance bulb. An appliance bulb is smaller than a standard 40 watt household bulb and is made to withstand high oven temperatures and have a much longer bulb life.
3. Replace the gasket, glass cover and glass retainer. Tighten screws securely.

REMOVABLE OVEN RACKS

To Install:

1. Set the raised back edge of the rack between a pair of guides
2. Push the rack in until you reach the bump in the rack guide, then lift the front of the rack up a bit and push the rack all the way in

See the cleaning instructions on page 17.

To Remove:

1. Pull the oven rack out, then up.

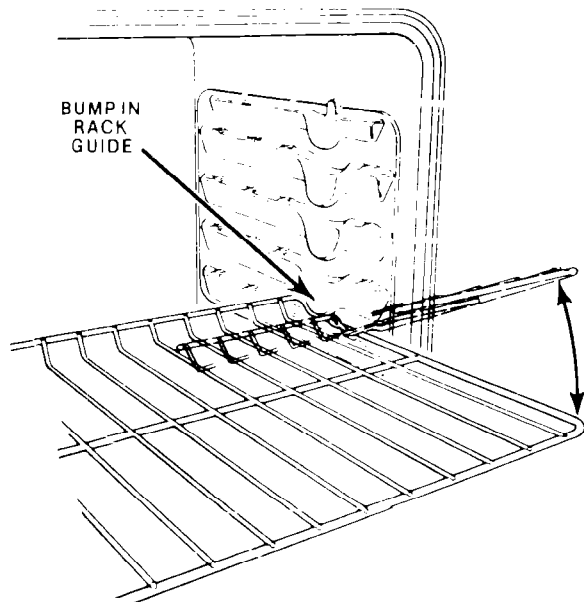

REMOVABLE STORAGE DRAWER

This drawer provides space for keeping cookware and bakeware. Plastics and flammable material should not be kept in this drawer.

Do not overload the storage drawer. If the contents of the drawer are too heavy, the drawer may slip off the track when opened. To open the drawer, grasp the center of the handle and pull straight out.

To remove: pull drawer straight out and lift over the guide stops. See the cleaning chart on page 17.

To replace: lift over the guide stops and slide drawer into place.

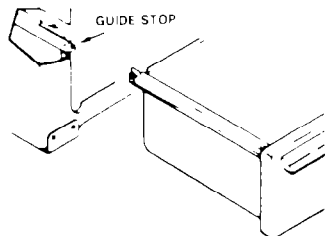

IF YOU HAVE A PROBLEM

Problems are often caused by little things that you can fix yourself without any tools. Make sure you are following the instructions in this book and read the list of common problems and solutions on this and the next page.

If you have a problem you cannot fix yourself, call your Roper dealer or authorized service agent for help.

ELECTRONIC RANGE CONTROL DOES NOT WORK

- Check to make sure range cord is plugged into outlet completely. Check for blown fuse or tripped circuit breaker.
- Check step by step operating instructions on pages 7 and 8.

RANGE IS BEEPING

- See the section on tones on page 8.

OVEN LIGHT OR PANEL LIGHT (Some Models) WILL NOT WORK

- Check to make sure range cord is plugged into outlet completely. Check for blown fuse or tripped circuit breaker.
- Check for loose or burned out bulb. See page 18 and 21 for replacement instructions.
- Panel light starter may have to be replaced. See page 18.

COOKTOP BURNER DOES NOT LIGHT

- Check to make sure range cord is plugged into outlet completely. Check for blown fuse or tripped circuit breaker.
- Range not properly grounded or polarized. This can affect ignition on spark ignition models. See your Installation Guide.
- Gas supply not connected or not turned on.
- A pan is sitting on your burner grate. This may partially block the free air flow needed for combustion. Remove the pan and try again.
- Burners not adjusted properly. See your Installation Guide for adjustment information.
- Food clogging burner or burner assembly misaligned. See page 19 on removing burner assemblies and also the cleaning instructions on page 17.

Continued on next page.

Continued from page 22

COOKTOP KNOBS WILL NOT TURN

- To turn from OFF position, push the knob in and then turn.

OVEN/BROILER BURNER DOES NOT WORK

- Check to be sure the range cord is plugged into the household outlet completely. Check for blown fuse or tripped circuit breaker.
- Range not properly grounded or polarized. This can affect ignition on spark ignition models. See your Installation Guide.
- Check for power outage.
- Is the electronic range control set correctly? See pages 7 and 8.
- Burners not adjusted properly. See your Installation Guide for adjustment information.

OVEN TEMPERATURE SEEMS INACCURATE

- Is proper air flow blocked by aluminum foil? See page 11 for tips on correct use of foil.
- Is oven vent blocked? See page 9.
- Check the section on baking problems and causes on page 13, and the tips on page 16.

- The oven thermostat on your new range may be more accurate than the one on your old range. See page 9 for information on adjusting the oven temperature.

BROILING PROBLEMS

- Electronic range control not set to BROIL. See page 7.
- Using wrong rack position. See chart on page 12.
- Aluminum foil not used properly and grease can't drain correctly. See page 11.

OVEN WILL NOT UNLOCK AFTER CLEANING

- The door will not unlock until the oven has cooled to a safe temperature. See page 16 for instructions on unlocking the door.

OVEN WILL NOT SELF-CLEAN

- Oven controls not set properly. Review step by step instructions on page 16.
- Heavy spillovers were not wiped up before starting clean cycle. See page 15.
- Oven too dirty — should be cleaned more often.