

90±1

86±1

66±1

70±1

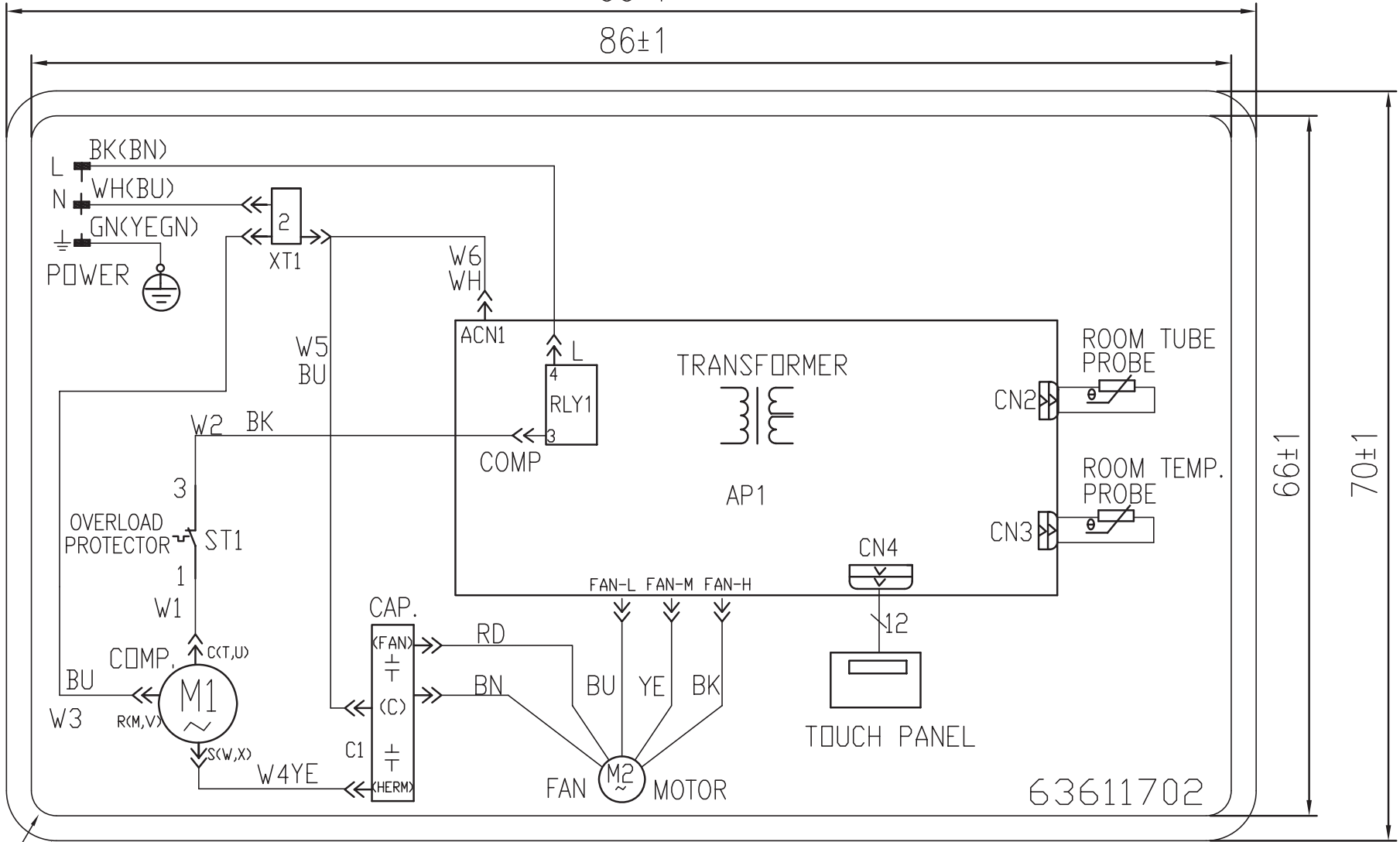

63611702

4-R2

4-R4