

Whirlpool 30-INCH FREE-STANDING EYE-LEVEL
MICROWAVE RANGE
 Models RM973PXL;
 RM975PXL

use & care guide

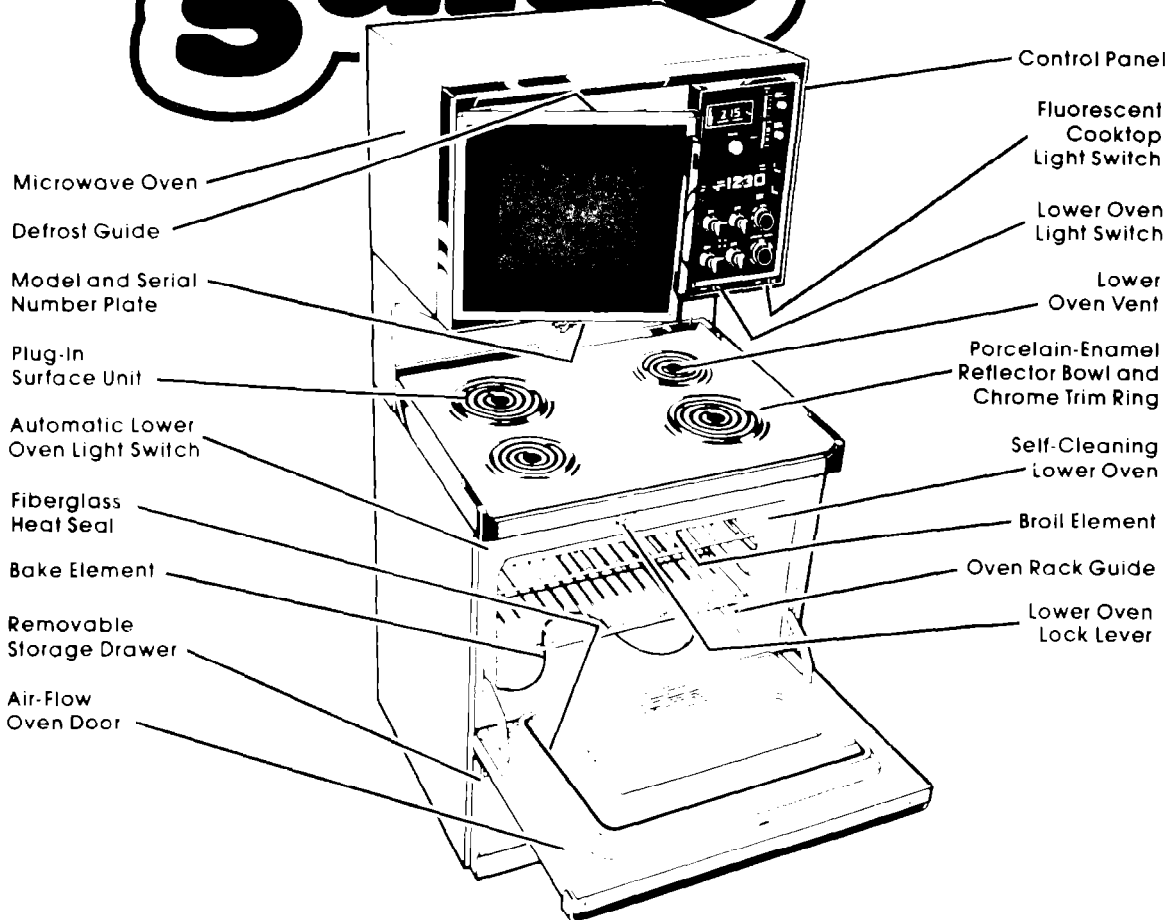

Copy Your Model and Serial Numbers Here

If you need service, or call with a question, have this information ready

1. **Complete** Model and Serial Numbers (from the plate just behind the microwave oven door on the oven frame)
2. Purchase date from sales slip

Copy this information in these spaces. Keep this book, your warranty and sales slip together in a handy place

_____ Model Number

_____ Serial Number

_____ Purchase Date

_____ Service Company and Phone Number

See the "Cooking Guide" for important safety information.

Your responsibilities...

Proper installation and safe use of your microwave range are your personal responsibilities. Read this "Use and Care Guide" and the "Cooking Guide" carefully for important use and safety information.

Installation

You must be sure your range is...

- installed and leveled on a floor that will hold the weight;
- installed in a well-ventilated area protected from the weather;
- properly connected to the correct electric supply and grounding. (See "Installation Instructions.")

Proper use

You must be sure your range is...

- used only for jobs expected of home ranges;
- used only by people who can operate it properly;
- properly maintained.

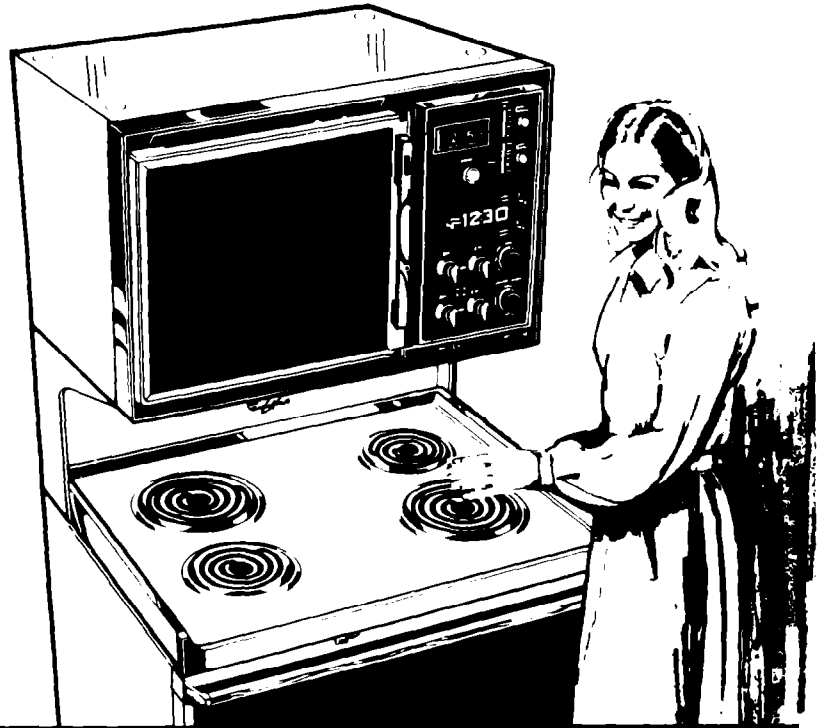

Contents

	Page		Page
Responsibilities	2	The Oven Temperature Control	12
Installation	2	Baking or Roasting	13
Proper Use	2	Adjusting the Oven Temperature Control	13
Safety	3	Using the Automatic MEALTIMER® Clock	14
Precautions to Avoid Possible Exposure to Excessive Microwave Energy	4	Broiling	15
Using Your Microwave Upper Oven	4	Broiling Chart	15
Setting the Controls	5	The Cooktop Light	16
Cook Power Chart	5	The Lower Oven Light	17
Defrosting	5	The Oven Vent	17
Keep Warm	5	Optional Accessories	17
The Meal Sensor® Temperature Probe	6	Rotisserie	17
Meal Sensor® Temperature Probe Guide	7	Canning Kit	17
Cleaning the Probe	7	Cleaning and Caring for Your Range	18
Bi-Level Cooking Rack	7	Control Panel and Knobs	18
Cleaning the Microwave Oven	8	Surface Units and Reflector Bowls	18
Important Information	8	Lift-Up Cooktop	19
How Microwave Ovens Work	10	Storage Drawer	20
The Microwave Oven Light	10	The Lower Oven Self-Cleaning Cycle	21
Using Your Cooktop and Lower Oven	11	Cleaning Chart	24
Surface Unit Controls	11	If You Need Service or Assistance	25
Setting the Clock	12	1. Before Calling for Assistance	25
Using the Minute Timer	12	2. If You Need Assistance	26
The Lower Oven Controls	12	3. If You Need Service	26
The Oven Selector	12	4. If You Have a Problem	26

*Tmk

Safety



DO NOT allow children to use or play with the range.

DO NOT store things children might want above the range.

DO NOT leave children unattended near the range.

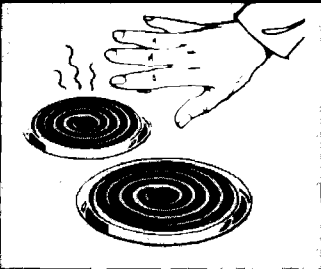

Red surface units are very hot, but dark surface units can still be hot enough to burn severely.

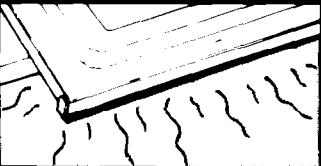

The oven frame, walls, racks and parts of the door can get hot enough to cause burns.

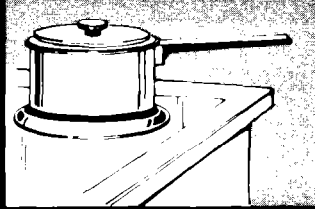

Keep pan handles turned in, but not over another surface unit.

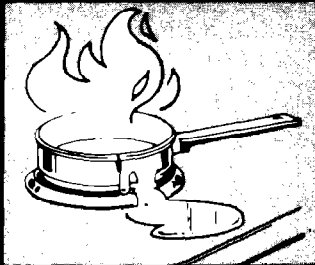

Make sure surface units are off when you are finished, and when you aren't watching.

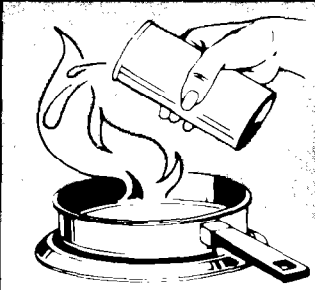

DO NOT use water on grease fires.



DO NOT line reflector bowls with foil. Shock or fire hazard can result.



DO NOT use wet pot holders. They can cause steam burns.

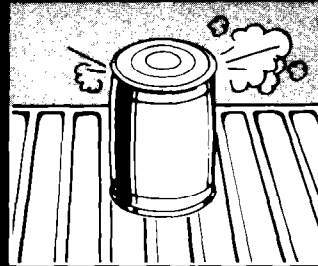

DO NOT heat unopened containers. They can explode.

DO NOT operate the microwave upper oven until you have read and understand ALL the information on safe use. Serious damage to the oven or injury to the user can result from not following directions.

DO NOT cook eggs in the shell in the microwave oven. Steam build-up in the egg will cause it to burst. Damage to the oven or injury to the user may result. Slice hard-boiled eggs before reheating to avoid steam build-up and possible bursting.

Remove the Consumer Buy Guide label before using your range.

PRECAUTIONS TO AVOID POSSIBLE EXPOSURE TO EXCESSIVE MICROWAVE ENERGY...

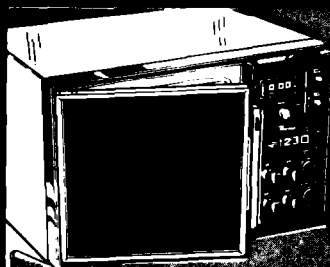

DO NOT attempt to operate this oven with the door open since open-door operation can result in harmful exposure to microwave energy. It is important not to defeat or tamper with the safety interlocks.

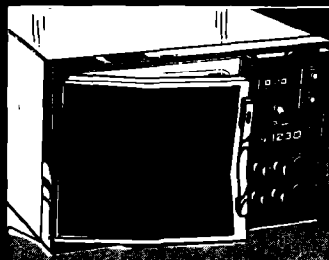

DO NOT operate the oven if it is damaged. It is particularly important that the oven door close properly and that there is no damage to the

- (1) Door (bent),
- (2) Hinges and latches (broken or loosened),
- (3) Door seals and sealing surfaces.

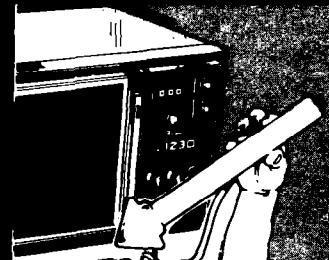

The microwave oven should be checked for microwave leakage by qualified service personnel after a repair is made.



DO NOT place any object between the oven front face and the door or allow soil or cleaner residue to accumulate on sealing surfaces.

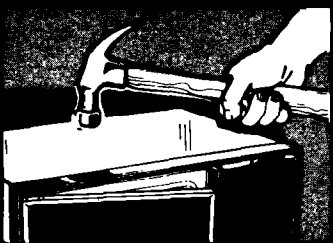

The oven should not be adjusted or repaired by anyone except properly qualified service personnel.

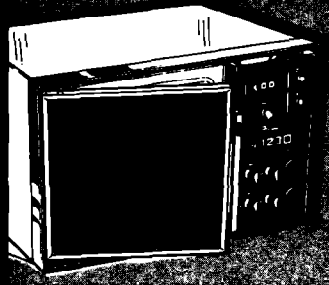

DO NOT operate the microwave oven if the door glass is broken.

DO NOT operate the microwave oven with the outer cabinet removed.

Using your microwave upper oven

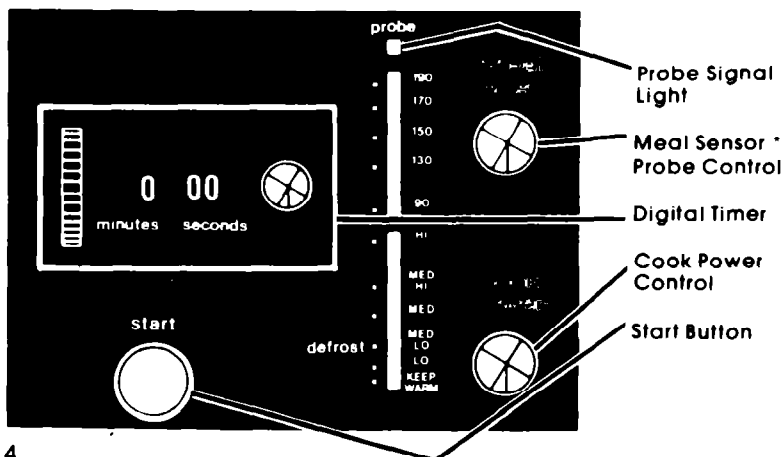

To Stop the Oven:

1. Push in and turn the timer knob counter-clockwise to 00:00.

OR

2. Open the oven door.

To Restart the Oven:

1. Close the oven door.
2. Set timer (if needed).
3. Push the START Button.

SETTING THE CONTROLS

Be sure you understand the basics of microwave oven cooking before you start. Start with recipes from your MICRO MENUS Cookbook. Follow the directions carefully.

NEVER START THE OVEN WHEN IT'S EMPTY. The oven can be damaged. For testing, use at least a cup of water.

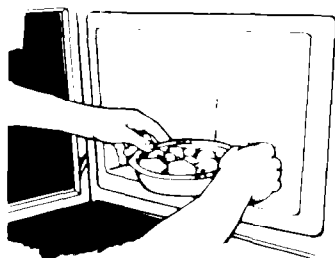

Be sure you have read and understand the directions.

1. Put food in the oven

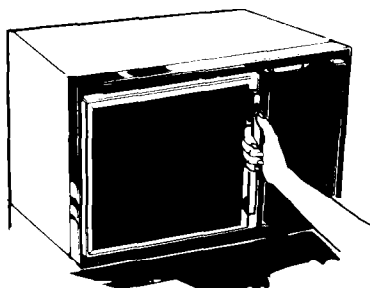

2. Close the door. Make sure it locks. The oven won't work if the door isn't closed tightly.

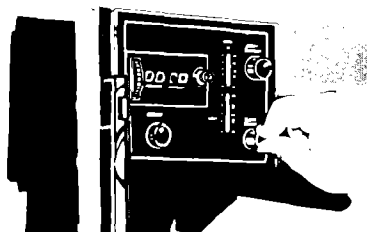

3. Set Cook Power to desired setting from HI to KEEP WARM. Some recipes require different Cook Powers for best results. (See chart below).

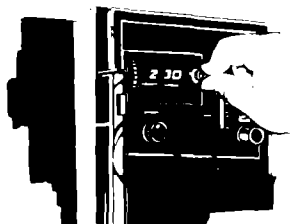

4. Set cooking times up to 10 minutes by **pushing** in the timer knob and turning clockwise. The oven light will go on. To set time for less than 30 seconds, turn timer past 30 seconds, then back to desired time.

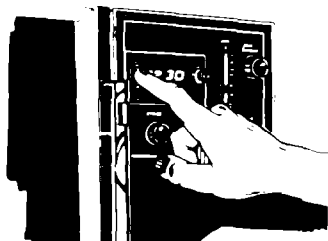

5. Set cooking times longer than 10 minutes by turning the timer knob **and** wheel. First set the knob, then move the wheel.

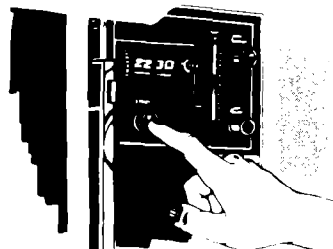

6. Push the START Button. The oven light will stay on. You will hear a fan running during oven operation.

When the set time is up, the oven will shut off automatically. You will hear a bell, the light will go off and the fan will stop.

DEFROSTING

For defrosting, set Cook Power Control to DEFROST (MED-LO). See the Defrost Guide inside the oven door or your MICRO MENUS Cookbook for suggested defrost times.

Example: To set 22 minutes 30 seconds

- Set 2 minutes, 30 seconds by pushing in and turning knob;
- Set 20 minutes by pushing up on wheel

COOK POWER CHART

Recipes in the MICRO MENUS Cookbook use Cook Power settings from HI to LO. Recipes in other books and magazines may use different percentages of cooking power. The following chart will be helpful:

HI	— 100% of full power
MED-HI	— 70% of full power
MED	— 50% of full power
MED-LO (DEFROST)	— 30% of full power
LO	— 15% of full power
KEEP WARM	— 5% of full power

KEEP WARM

- Hot, cooked foods can be safely kept warm for 60 minutes.
- Reset the timer if more time is required. Keeping foods warm longer than about 1 hour, 40 minutes **is not recommended**. The quality of some foods will suffer with extended time.
- Foods cooked covered should be covered during KEEP WARM.
- Pastry items (pies, turnovers, etc.) should be uncovered during KEEP WARM.
- Meals kept warm on a plate should be covered during KEEP WARM.

THE MEAL SENSOR* TEMPERATURE PROBE

The MEAL SENSOR Temperature Probe helps take guesswork out of cooking roasts and larger casseroles. The probe is designed to turn off the oven when it senses the temperature you want. See your MICRO MENUS Cookbook for helpful information in cooking different types of foods.

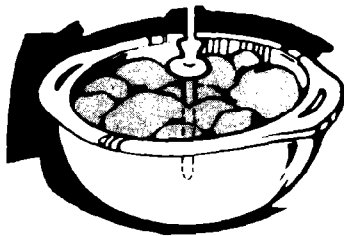

For casseroles, the tip of the probe should be in the center of the food. Stir foods when recommended. Replace the probe.

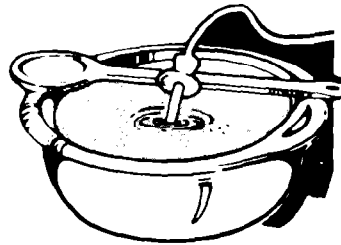

For liquids, balance the probe on a wooden spoon or spatula so the tip of the probe is in the center of the liquid.

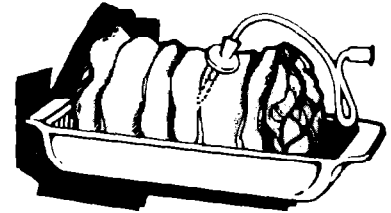

For roasts, the tip of the probe should be in the center of the largest muscle, but not touching fat or bone.

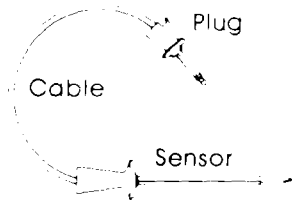

1. Insert at least $\frac{1}{3}$ of the temperature probe into the food.

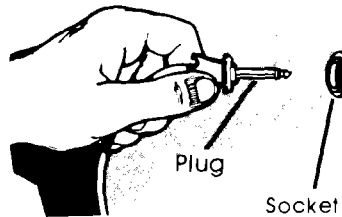

2. Place food in the oven and plug the probe into the socket on the oven wall. The Probe Signal Light will come on.

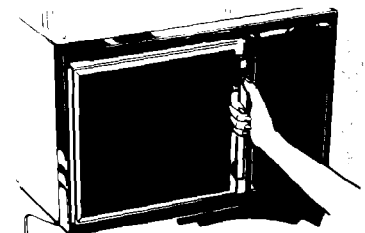

3. Make sure the probe does not touch any part of the oven interior. Close the door.

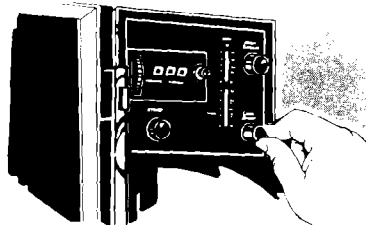

4. Set the Cook Power if desired.

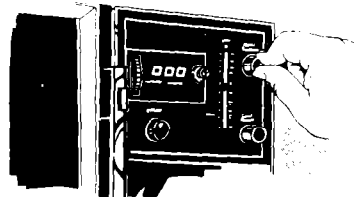

5. Move the Meal Sensor pointer to the final cooking temperature you want.

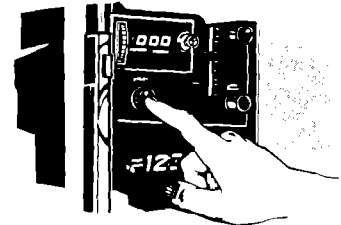

6. Push the START Button. When the probe senses the cooking temperature, a buzzer sounds, and the oven turns off.

DO...

- use hot pads when removing probe from food or food from oven.
- unplug probe from socket to turn off oven light.
- stir foods during cooking when recommended.
- stir soups, casseroles and drinks before serving.
- cover roasts with foil and let stand a few minutes after cooking. Remove foil if you decide to cook it longer.

DON'T...

- let probe or probe cable touch any part of the oven interior.
- let probe touch foil (if used). Foil can be kept away from probe with wooden toothpicks. Remove foil if arcing occurs.
- use paper, plastic wrap or plastic containers. They will be in the oven too long.
- use probe in regular oven.
- force probe into frozen food.
- use probe for foods that need to simmer.

MEAL SENSOR* TEMPERATURE PROBE GUIDE

Food	Cook Power Setting	Meal Sensor Setting	Tips
Beverages	HIGH	165 F to 170 F	Balance probe on wooden spoon.
Canned Food	HIGH	170 F	Use MEDIUM Cook Power for very thick foods such as baked beans.
Casseroles	MEDIUM HIGH	170 F to 175 F	Use MEDIUM Cook Power for very thick mixtures. Stir once or twice.
Chowders	MEDIUM HIGH	180 F	Balance probe on wooden spoon. Stir once or twice.
Dips	MEDIUM	140 F	
Meat Loaf (beef)	MEDIUM HIGH	170 F	
Poultry	Do not use the Meal Sensor probe when cooking poultry. Because of the amount of bone and shape of poultry, there is no place where the meat is thick enough to place the probe properly.		
Sandwiches	MEDIUM	110 F	Place sandwich on paper napkin. Insert probe from side so tip is in center of filling. Thick sandwiches work best.
Soup	HIGH	165 F to 170 F	Balance probe on wooden spoon. Stir once or twice.

TIPS

- Casseroles cooked using the MEAL SENSOR probe should be made from precooked foods. Do not use raw meats, raw vegetables and cream sauces in casseroles.
- Dry casseroles do not work well.
- Thaw frozen casseroles and meats in the microwave oven before inserting the probe.
- If you are cooking individual servings such as mugs of soup, check the probe setting in several of the items – all the mugs may not heat at the same rate.
- Dry meat loaf mixtures don't work well.
- Remember that roasts may vary in size, shape and composition. Use the timings for minutes per pound as a guideline as well as the MEAL SENSOR probe.
- Starchy vegetables tend to stick to the MEAL SENSOR probe.

CLEANING THE PROBE:

1. Remove probe from microwave oven using hot pads.
2. Wipe probe with a hot sudsy cloth. Use a plastic scouring pad to remove stubborn foods.
3. Probe may be placed in the silverware basket of the dishwasher.
4. Be careful not to kink the cable.

NOTE: Make sure you have the right probe for your oven. It will have "LO-Z" on the handle.

BI-LEVEL OVEN RACK

Use the Bi-Level Oven Rack to stack foods when cooking in more than one container. The rack can be turned upside-down to help fit taller containers on the bottom of the oven.

First Position: Use the rack only when heating more than one container of food.

Do not let a container touch the top of the oven.

Second Position: Turn rack upside-down when using a taller container on the bottom of the oven.

CLEANING THE RACK

- Wash by hand with a mild detergent.
- Wash on the **top rack** of a dishwasher.
- **Do not** use abrasive scrubbers or cleansers.

SPECIAL CAUTIONS

- Put food in containers, then place containers on rack.
- **Do not** cook foods directly on rack without putting them in containers first.
- **Do not use with browning dish.**
- **Use only** in the microwave oven.
- **Do not** let food or container touch the top of the oven.
- **Do not** store rack in the oven.
- **Use only** when cooking foods in more than one container.

CLEANING THE MICROWAVE OVEN

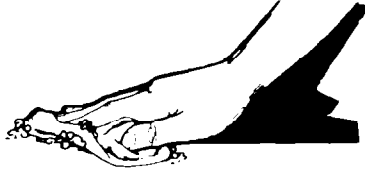

Wipe often with warm sudsy water and a soft cloth or sponge. The control panel may be cleaned with a soft soapy cloth or spray glass cleaner.

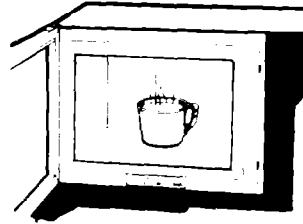

For stubborn soil, boil a cup of water in the oven for 2 or 3 minutes. Steam will soften the soil.

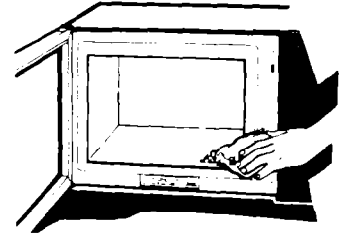

Be sure to clean the areas where the door and oven frame touch when closed. Rinse well.

Do not use abrasive cleaners or steel wool pads.

IMPORTANT INFORMATION

Before you start using your microwave oven, read this section carefully. This information will help you avoid damage to your oven.

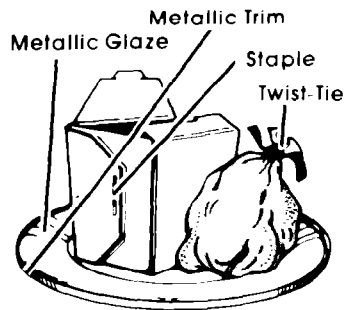

Cooking in metal containers **can damage the oven**. So can containers with **hidden metal** (twist-ties, foil-lining, staples, metallic glaze or trim). *Test dinnerware or cookware before using.*

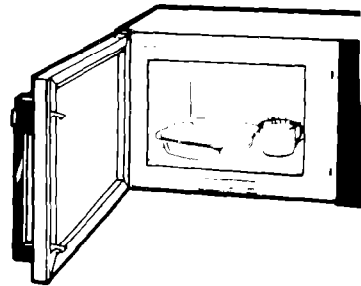

To test a dish for safe use, put it into the oven with a cup of water **beside** it. Cook on high Cook Power for one minute. **If the dish gets hot and the water stays cool, do not use it.**



NEVER COOK OR REHEAT A WHOLE EGG. Slice hard boiled eggs before heating. Steam build-up in whole eggs may cause them to burst and possibly damage the oven.

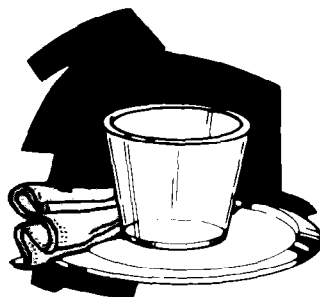

Paper can char or burn, and some plastics can melt if used when heating foods for more than 4 minutes.

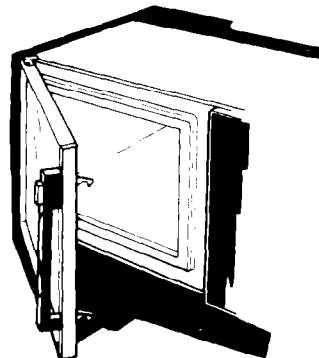

NEVER start a microwave oven when it's empty. The oven can be damaged. If you experiment, put a container of water in the oven.

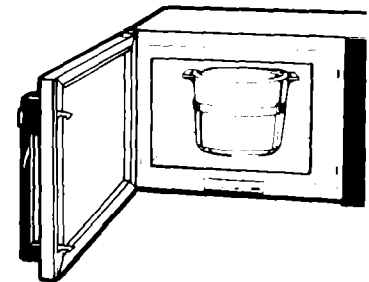

Don't let anything touch the top of the oven cavity.

Continued next page



Rough or harsh cleaners can scratch or dull the oven finish. **DO NOT USE THEM.**

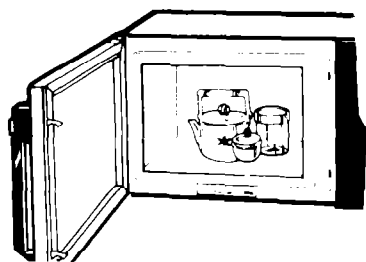

DO NOT store things in the oven.

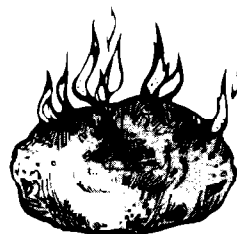

Overcooking some foods can cause them to scorch or flame...especially foods like potatoes, corn, snacks, etc. See the **MICRO MENUS Cookbook**.

•Tmk

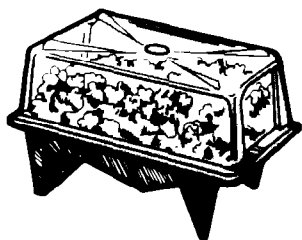

Make popcorn only in poppers designed for use in microwave ovens. Follow popper directions. Results are the popper manufacturer's responsibility.

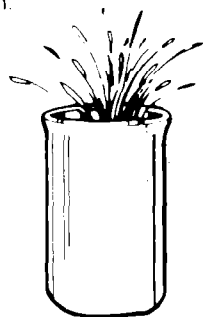

Liquids heated in certain containers may overheat. The liquid may then splash out with a loud noise. This does not harm the oven, but you should not use such containers to heat liquids again.



DO NOT OVERCOOK POTATOES. At the end of the recommended cooking time they should be slightly firm. Wrap in foil and set aside for 5 minutes. They will finish cooking while standing.

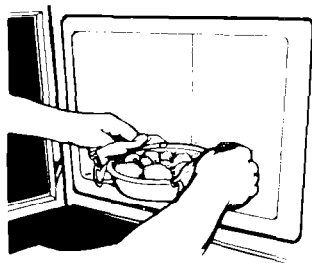

USE HOT PADS. Microwave energy does not heat containers, but the hot food does.

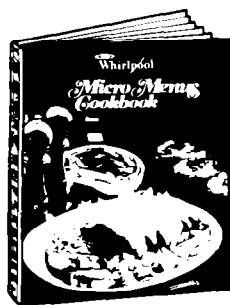

Follow **MICRO MENUS Cookbook** directions carefully to properly cook different types of food. If using a different cookbook, you may need to experiment with times and Cook Powers.

- Double-check all settings.
- Use the oven only for defrosting, cooking or reheating.

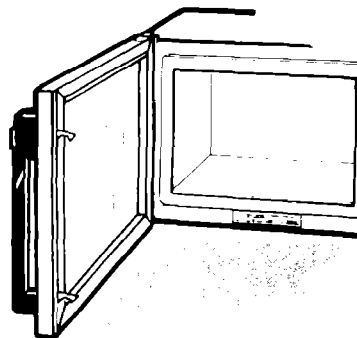

It is normal for the inside of the oven door to look wavy after the oven has been running for a while.

At times, an extra fan automatically turns on to help protect the microwave oven from excess heat; you may notice a louder sound level when this fan is running.



If your electric power line voltage is less than the normal 240 volts, cooking times may be longer.

HOW MICROWAVE OVENS WORK

Microwave ovens are safe. Microwave energy is not hot. It causes food to make its own heat, and it's this heat that cooks the food.

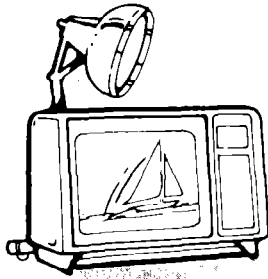

Microwaves are like TV waves or light waves. You can't see them, but you can see what they do.

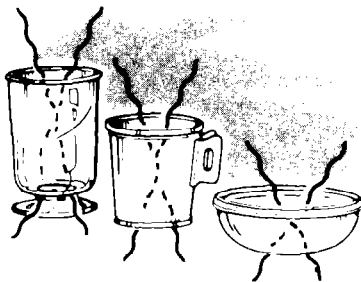

Microwaves pass through glass, paper and plastic without heating them so food absorbs the energy. Microwaves bounce off metal pans so food does not absorb the energy.

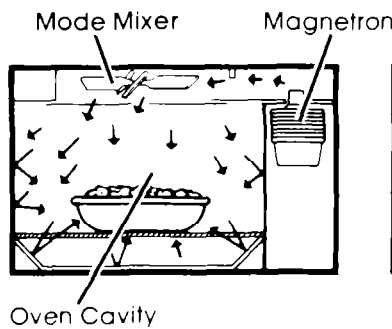

A magnetron produces microwaves. The microwaves move into the oven where they are scattered around by a stirrer (like a fan). Microwaves bounce off metal oven walls and are absorbed by food.

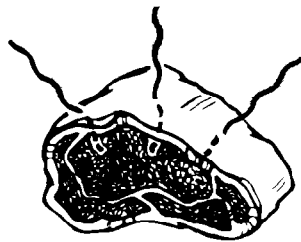

Microwaves may not reach the center of a roast. The heat around the outside is what cooks the roast all the way through. This is one of the reasons for letting some foods (roasts, baked potatoes) stand for a while after cooking, or for stirring some foods during the cooking time.

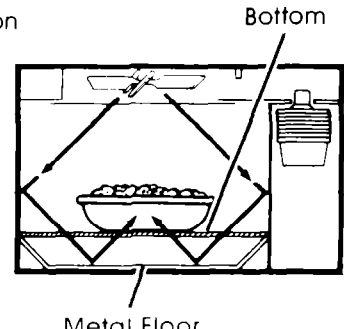

The bottom of your microwave oven lets microwaves through. Then they bounce off the metal floor, back through the bottom, and are absorbed by the food.



The microwaves disturb water molecules in the food. As the molecules bounce around bumping into each other, heat is made, like rubbing your hands together. This is the heat that cooks.

THE MICROWAVE OVEN LIGHT

The light in the microwave oven comes on when the door is open, when a cooking time is set, when the oven is on, and when the temperature probe is plugged into its socket.

To replace the light bulb:

1. Move range away from the wall. **Be very careful. It is heavy.**
2. Unplug the power cord.
3. Remove holding screw on access panel.
4. Remove the cardboard baffle from the bulb.
5. Replace the bulb with a 40-watt **appliance** bulb.
6. Replace the cardboard baffle and the access panel.
7. Plug in the power cord and move the range back into position.

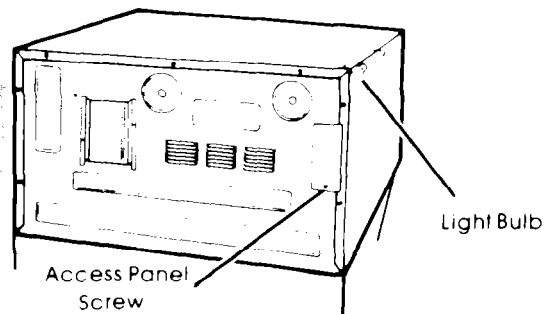

Using your cooktop and lower oven

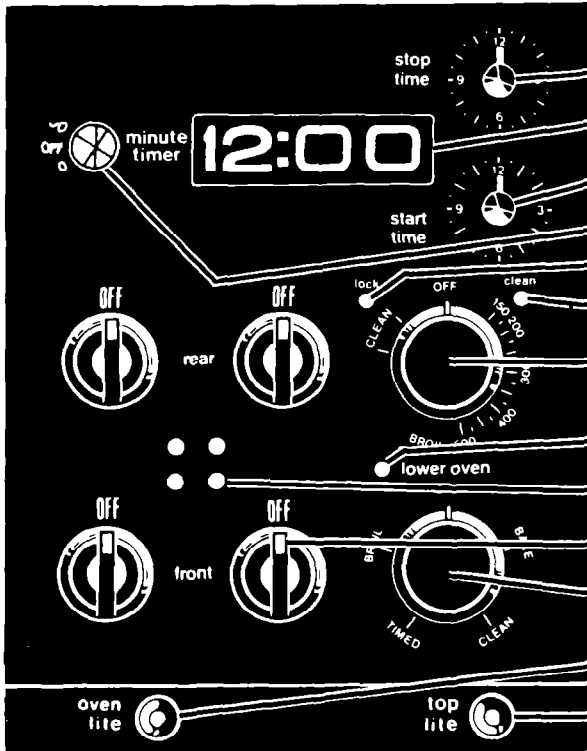

COOKTOP AND LOWER OVEN CONTROLS

- Stop Time Knob
- Digital Automatic MEALTIMER Clock
- Start Time Knob
- Minute Timer
- Lock Light
- Clean Light
- Adjustable Lower Oven Temperature Control
- Lower Oven Signal Light
- Surface Unit Signal Lights
- Surface Unit Control
- Lower Oven Selector
- Manual Lower Oven Light Switch
- Cooktop Light Switch

Tmk

SURFACE UNIT CONTROLS

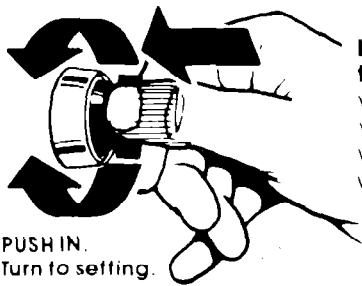

Control knobs must be pushed in before turning. Turn either way until the setting you want shows in the window. Set them anywhere from HI to OFF.

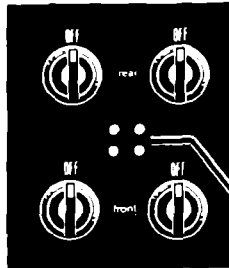

One of the signal lights will glow to remind you which surface unit is on. **Be sure all signal lights are off when you are not cooking.**

Signal lights match location of surface units on cooktop.

Until you get used to the settings, use the following as a guide.

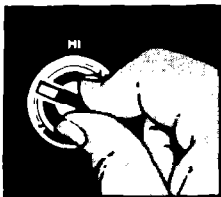

Use HI to start foods cooking or to bring liquids to a boil. **Surface unit will not turn red if good contact is made with bottom of pan.**

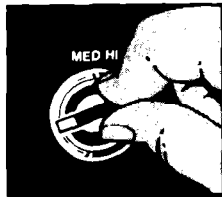

Use MED-HI to hold a rapid boil or to fry chicken or pancakes.

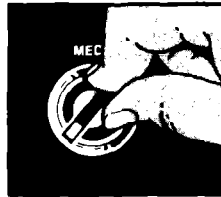

Use MED for gravy, puddings and icings, or to cook large amounts of vegetables.

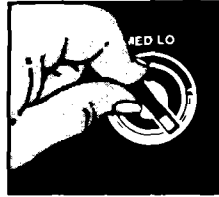

Use MED-LO to keep food cooking after starting it on a higher setting.

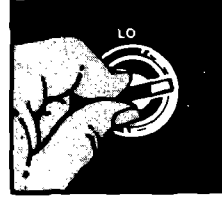

Use LO to keep food warm until ready to serve. Set the heat higher or lower within the LO band to keep food at the temperature you want.

See "The Accessory Canning Kit" (page 17) and your "Cooking Guide" for important utensil information.

SETTING THE CLOCK

Push in and turn the Minute Timer Knob to set the Clock.

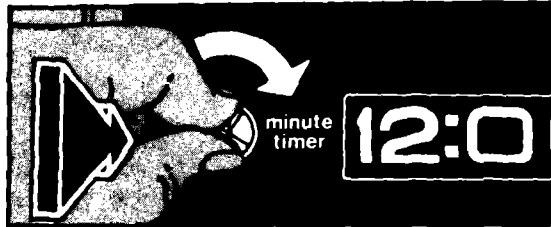

1. Push in Minute Timer Knob and turn clockwise until clock digits show the right time of day.



2. Let the Minute Timer Knob pop out. Turn counterclockwise until the Minute Timer dial shows OFF. The clock setting will change if you push in when turning.

USING THE MINUTE TIMER

DO NOT PUSH IN THE KNOB when setting the Minute Timer.

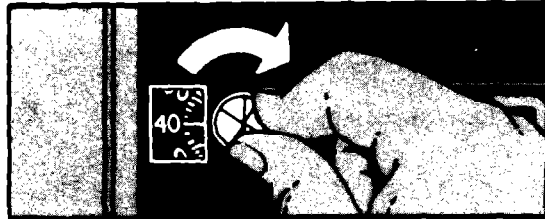

1. Without pushing in the Minute Timer Knob, turn it until the time showing in the window is longer than you want.

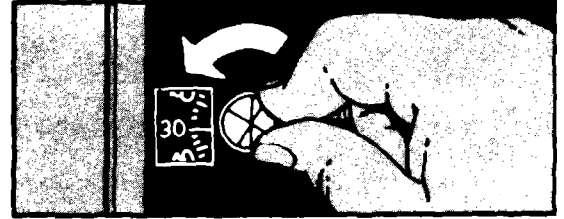

2. Without pushing in, turn the knob back so the setting you want shows in the window.
3. When the time is up, a buzzer will sound. To stop the buzzer, turn the dial to OFF without pushing in the knob.

PUSHING IN AND TURNING THE KNOB CHANGES THE CLOCK SETTING.

THE LOWER OVEN CONTROLS

The lower oven is controlled by two knobs: the Oven Selector and the Oven Temperature Control. Both must be on a setting for the oven to heat.

THE OVEN SELECTOR



With the Oven Selector on BROIL, only the top element heats. (Broiling, pg. 15).



With the Oven Selector on BAKE, the bottom element does most of the work. The top element heats, but does not turn red. (Baking, pg. 13).

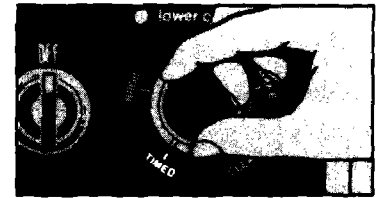

With the Oven Selector on TIMED, the MEALTIMER Clock can be used to turn the oven on and off automatically. (MEALTIMER Clock, pg. 14).

THE OVEN TEMPERATURE CONTROL

Use the Oven Temperature Control to set baking or roasting temperature when the Oven Selector is on BAKE or TIMED.

When both the Oven Selector and Temperature Control are on BROIL, the broil element heats all the time.

The Oven Temperature Control can be set on a temperature for slower broiling (see Broiling, page 15).

·Tmk

BAKING OR ROASTING

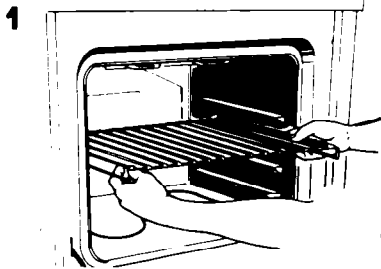

Lift rack at front and pull out.

Put the rack(s) where you want them before turning on the oven. Rack(s) should be placed so food can be centered in the oven. Always leave at least 1 1/2 to 2 inches (4-5 cm) between the sides of the pan and the oven walls and pans. For more information, see the "Cooking Guide."

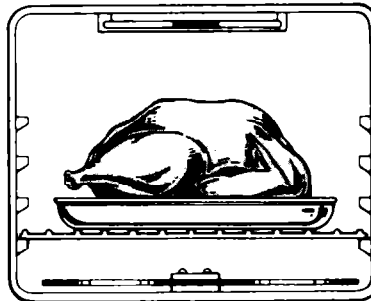

Set the Oven Selector on BAKE.



Set the Oven Temperature Control to the baking temperature you want.

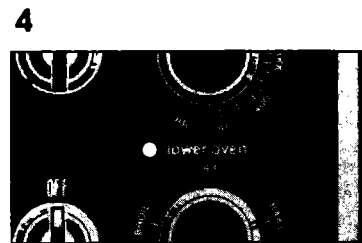

Let the oven preheat until the Signal Light goes off.

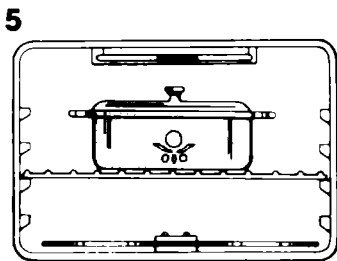

Put food in the oven. Oven rack, walls and door will be hot.

During baking, the elements will turn on and off to help keep the oven temperature at the setting. The Signal Light will turn on and off with the elements. The top element helps heat during baking, but does not turn red.



When baking is done, turn both knobs to OFF.

ADJUSTING THE OVEN TEMPERATURE CONTROL

Does your new oven seem to be hotter or colder than your old oven at the same settings? The temperature setting in your old oven may have changed gradually over the years. The accurate setting of your new oven can seem different. If you think the oven temperature needs adjusting, follow these steps:

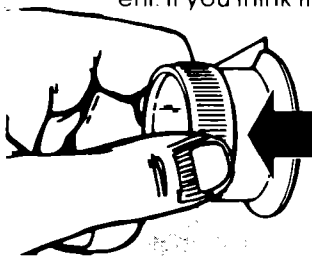

1. Pull the Oven Temperature Control straight off.

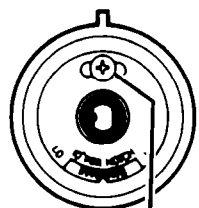

2. Loosen the locking screw; NOTICE position of notches.

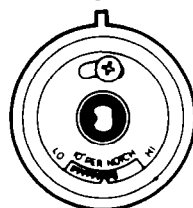

3. To lower the temperature, move black part of knob closer to LO. Each notch equals about 10°F (5°C).

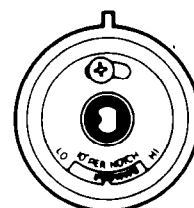

4. To raise the temperature, move black part of knob closer to HI. Each notch equals about 10°F (5°C).

Tighten the locking screw. Replace the knob.

USING THE AUTOMATIC MEALTIMER® CLOCK

The Automatic MEALTIMER Clock is designed to turn the **lower oven** on and off at times you set...even when you are not around.

To start and stop baking automatically:

*Tmk

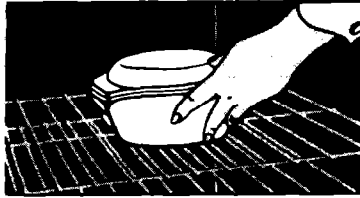

1. Put the lower oven rack(s) where you want them and place the food in the oven.



2. Make sure the clock is set to the right time of day.



3. Push in and turn the Start Time Knob **clockwise** to the time you want baking to start.



4. Push in and turn the Stop Time Knob **clockwise** to the time you want the oven to shut off.

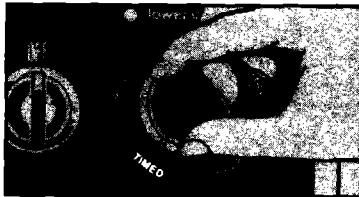

5. Set the Oven Selector on TIMED.

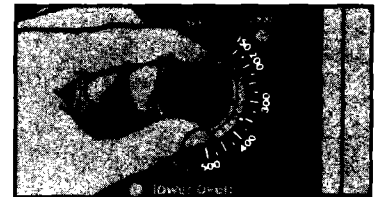

6. Set the Oven Temperature Control on the baking temperature you want.

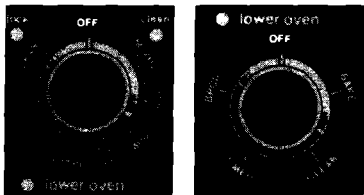

7. After baking is done, turn both knobs to OFF.
8. To stop the oven before the preset time, turn both knobs to OFF.

To stop baking automatically:

1. Put the oven rack(s) where you want them and place the food in the oven.
2. Make sure the clock is set to the right time of day.
3. Push in and turn the Stop Time Knob **clockwise** to the time you want the oven to shut off.
4. Set the Oven Selector on TIMED.
5. Set the Oven Temperature Control on the baking temperature you want.
6. After baking is done, turn both knobs to OFF.
7. To stop the oven before the preset time, turn both knobs to OFF.

SPECIAL CAUTION:

Use foods that will not go bad or spoil while waiting for cooking to start. Avoid using dishes with milk or eggs, cream soups, cooked meats or fish, or any item with baking powder or yeast.

Smoked or frozen meats may be used; so can vegetables, fruits and casserole-type foods. Vegetables can be cooked in

a covered baking dish with about a half-cup (118 mL) of water for 1 to 1½ hours.

Any food that has to wait for cooking to start should be very cold or frozen before it is put in the oven. **MOST UNFROZEN FOODS SHOULD NEVER STAND MORE THAN TWO HOURS BEFORE COOKING STARTS.**

BROILING

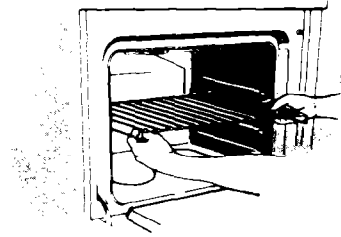

1. Place the rack where you want it for broiling.



2. Put the broiler pan and food on the rack.

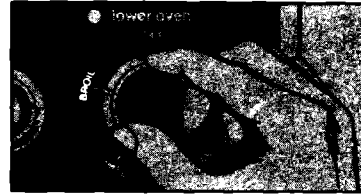

3. Set the Oven Selector on BROIL.



4. Set the Oven Temperature Control on BROIL (or on a lower temperature for slower broiling).

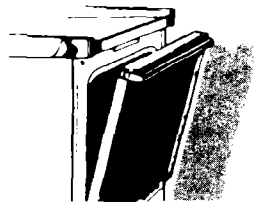

5. During broiling, the oven door must be partly open. A built-in stop will hold it there.

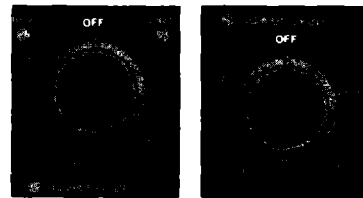

6. When broiling is done, turn both knobs to OFF.

For slower broiling, set the Oven Temperature Control on a temperature instead of BROIL. The broil element will then turn on and off instead of staying on. The lower the temperature setting, the slower the broiling.

The Oven Selector must be on BROIL and the door partly open for all broiling temperatures.

Suggested oven-rack positions and broiling times



Food	Description	inches (cm) from top of food to Broil Element	Approximate Minutes – Temperature set to BROIL	
			1st side	2nd side
Beef Steaks				
Rare	1" (2.5 cm)	3" (8 cm)	7-9	3-5
Medium	1" (2.5 cm)	3" (8 cm)	9-11	4-7
Well done	1" (2.5 cm)	3" (8 cm)	11-13	5-7
Beef Steaks				
Rare	1 1/2" (4 cm)	4"-5" (10-13 cm)	13-15	6-8
Medium	1 1/2" (4 cm)	4"-5" (10-13 cm)	17-19	8-10
Well Done	1 1/2" (4 cm)	4"-5" (10-13 cm)	19-21	14-16
Hamburgers	1/2" (1 cm)	3" (8 cm)	6-8	4-5
Lamb Chops				
Medium	1" (2.5 cm)	3" (8 cm)	6-8	4-5
Ham slice, precooked or tendered				
	1/2"-1" (1-2.5 cm)	3" (8 cm)	6-8	4-5
Canadian Bacon	1/2" (1 cm)	3" (8 cm)	6	4
Pork Rib or Loin Chop				
Well done	3/4"-1" (2-2.5 cm)	4"-5" (10-13 cm)	15	10
Chicken				
	2-3 lb. (1-1.5 kg) cut in half	7"-9" (18-23 cm)	25-30	10-12
Fish				
whole		3" (8 cm)	11-16	9-14
fillets		3" (8 cm)	7-8	5-7
Liver				
	1/2"-3/4" (1-2 cm)	3" (8 cm)	3	3
Frankfurters		4"-5" (10-13 cm)	6-7	4-5

THE COOKTOP LIGHT

To turn on the fluorescent light under the upper oven, push the button under the control panel marked **TOP LITE**. Hold it in for a second before letting it go. Push it again to shut off the light.

To replace the light tube:

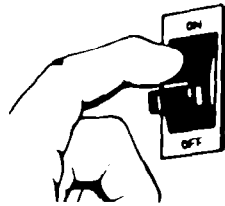

1. Turn off the electric power at main power supply.

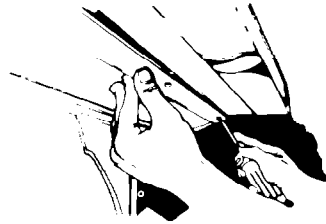

2. Remove the 3 screws and front metal trim that supports the light cover. **The glass is heavy. Hold it securely.**

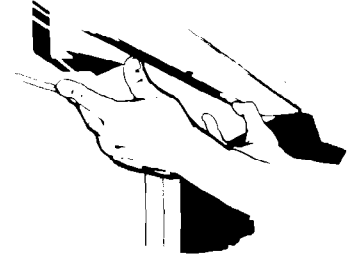

3. **With both hands,** lower the front of the cover a little and pull it straight toward you.

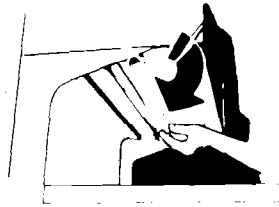

4. Turn top of fluorescent tube toward you until it comes out of the receptacles at both ends.

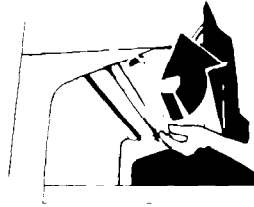

5. Replace with a 20-watt cool-white fluorescent tube.

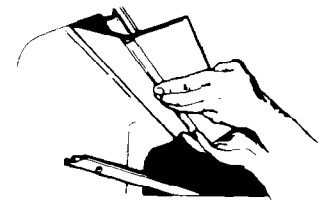

6. **With both hands,** carefully fit the glass cover into the metal support trim at the back.

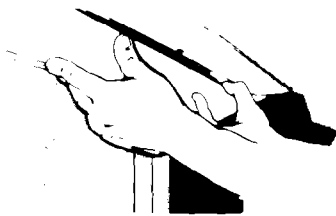

7. Slide the cover back far enough for the front to fit behind the spring tabs at the ends.

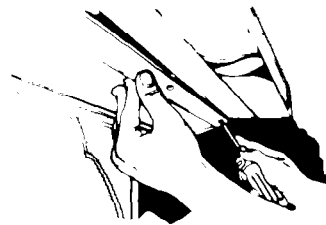

8. Replace the front support trim and the 3 screws.

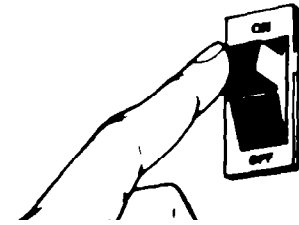

9. Turn electric power back on at main power supply.

THE LOWER OVEN LIGHT

The lower oven light will come on when you open the oven door or when you push the **Oven Light** switch at the bottom of the control panel. Close the oven door or push the switch again to shut it off.

To replace the light bulb:

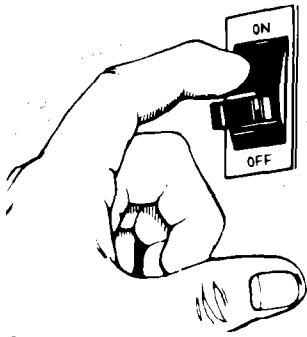

1. Turn off the electric power at the main power supply.

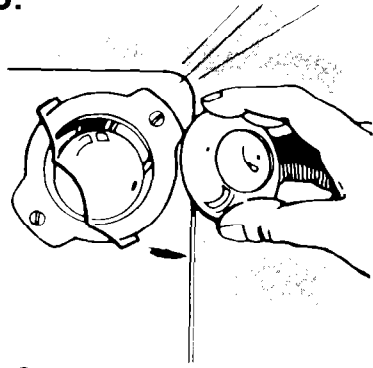

2. Remove the bulb cover by pulling out on the wire holder and moving it to the side.

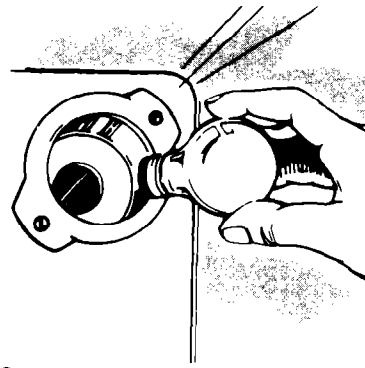

3. Remove the light bulb from its socket.

4. Replace the bulb with a 40-watt **appliance** bulb available from most grocery, variety and hardware stores.

5. Replace the bulb cover and snap the wire holder in place. **The bulb must have this cover when the oven is being used.**

6. Turn the power back on at the main power supply.

THE OVEN VENT

Hot air and moisture escape from the lower oven through a vent under the right rear surface unit. You can cook on the unit, or keep food warm on it while the oven is on. **Plastic utensils left over the vent can melt. Do not block the vent.** Poor baking can result.

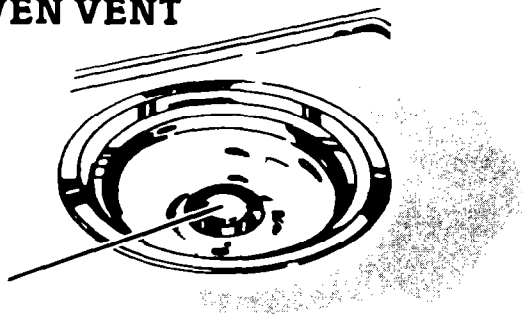

Optional Accessories

ROTISSERIE

If you would like a rotisserie for your lower oven, you can order a kit (Part No. 261881) from your dealer. The kit includes easy installation instructions.

CANNING KIT (Part No. 242905)

The large diameter of most water-bath or pressure canners combined with high heat settings for long periods of time can shorten the life of regular surface units and cause damage to the cooktop.

If you plan to use the cooktop for canning, we recommend the installation of a Canning Kit. Order the kit from your Whirlpool Dealer or Tech-Care Service Company.

Use only flat-bottomed utensils for best results and to prevent damage to the range. Specialty items with rounded or ridged bottoms (woks, ridged bottom canners or tea kettles) are not recommended. See the "Cooking Guide" for important utensil information.

SEE THE "COOKING GUIDE" FOR IMPORTANT CANNING INFORMATION

Cleaning and caring for your range

CONTROL PANEL AND KNOBS

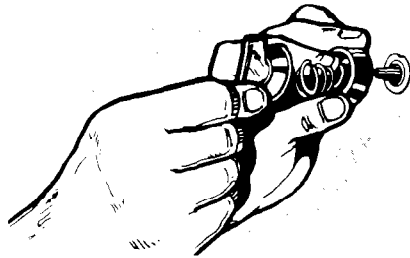

1. First make sure lower oven and surface unit control knobs are set on OFF. All knobs pull straight off. Surface unit knobs have a collar and spring.

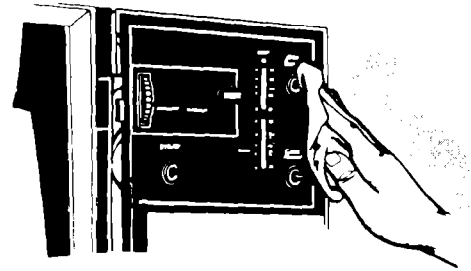

2. Use warm soapy water and a soft cloth to wipe the panel. Rinse and wipe dry.

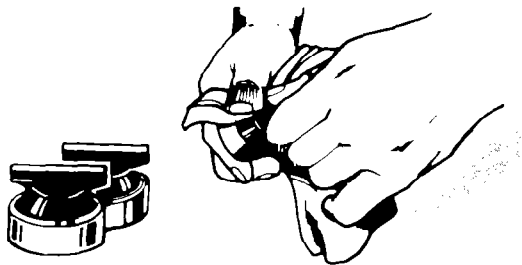

3. Wash knobs and surface unit collars in warm soapy water. Rinse well and dry.

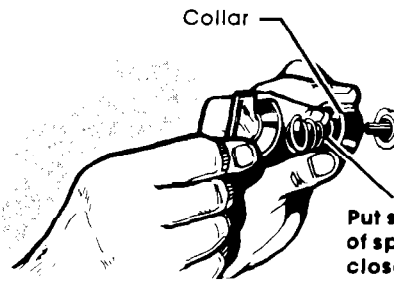

4. Push knobs straight back on. Make sure they point to OFF. Make sure the collar and spring on surface unit knobs are put together as shown.

SURFACE UNITS AND REFLECTOR BOWLS

REMOVING

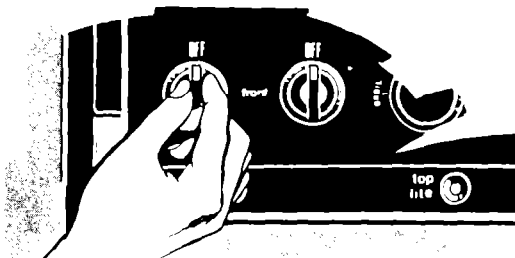

1. Be sure surface units are OFF and COOL.

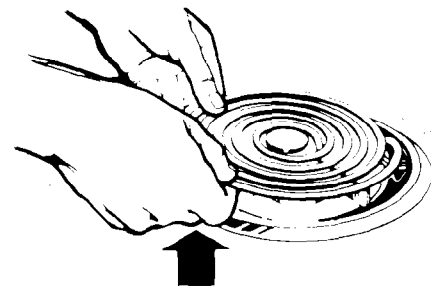

2. Lift the edge of the unit opposite the receptacle just enough to clear the reflector bowl.

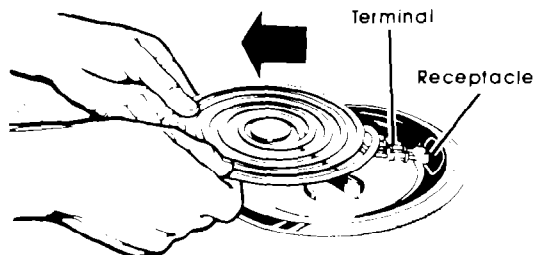

3. Pull the surface unit straight away from the receptacle.

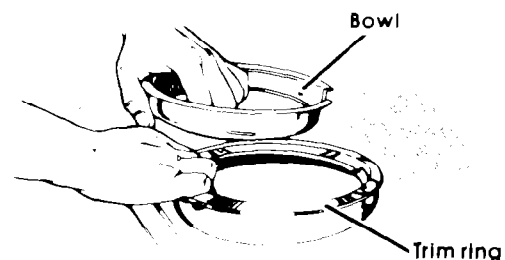

4. Lift out the reflector bowl and trim ring.

REPLACING

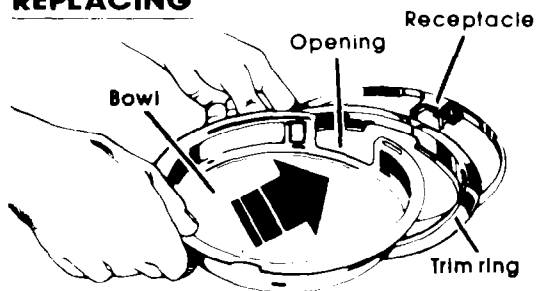

1. Be sure surface unit controls are **OFF**.
2. Line up opening in the reflector bowl and notch in trim ring with the surface unit receptacle.

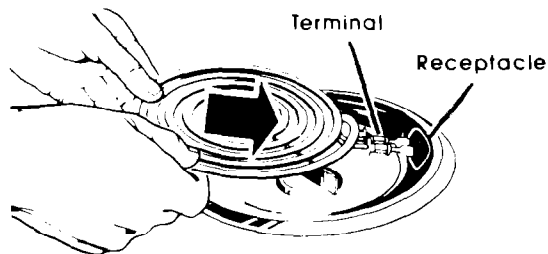

3. Hold the surface unit as level as possible with the terminal just started into the receptacle.

Reflector bowls reflect heat back to the utensils on the surface units. They also help catch spills. When they are kept clean, they reflect heat better and look new longer.

If a trim ring gets discolored, some of the utensils used may not be flat enough. Or some may be too large for the surface unit. In either case, some of the heat that is meant to go into or around a utensil goes down and heats the trim ring. This extra heat can discolor it.

DO NOT LINE THE REFLECTOR BOWLS WITH FOIL. Use of foil can cause shock or fire hazard.



4. While pushing the surface unit terminal into the receptacle, lift a little on the edge of the unit nearest the receptacle.
5. When the terminal is pushed into the receptacle as far as it will go, the surface unit will fit into the trim ring.

LIFT-UP COOKTOP

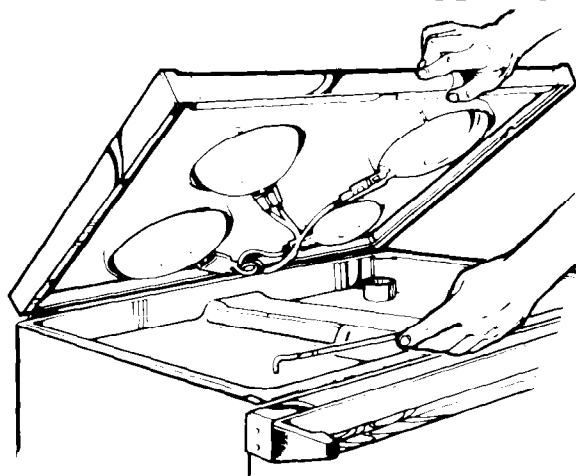

1. Lift the front of the cooktop at the center and swing the support rod up.

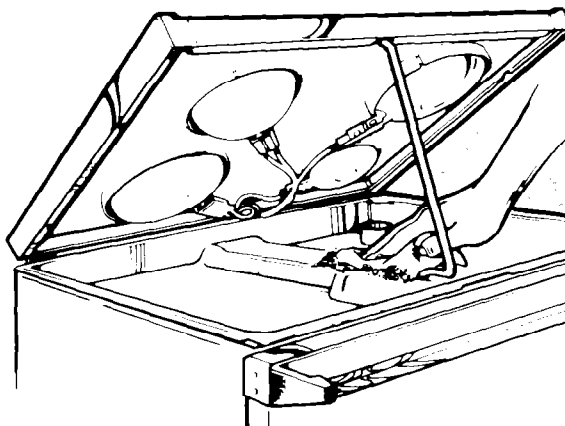

2. Carefully lower the cooktop onto the support rod. Be sure the tip of the rod fits in the notch in the cooktop.
3. Wipe with warm soapy water. Use soapy steel wool pad on stubborn spots.

**DO NOT let the cooktop bump the upper oven when lifting.
DO NOT drop the cooktop. Damage can result.**

STORAGE DRAWER

The storage drawer is for storing pots and pans. **Never store anything that can burn or melt in the drawer.** The drawer is warm when baking in the lower oven. Use care when handling the drawer.

REMOVING THE STORAGE DRAWER

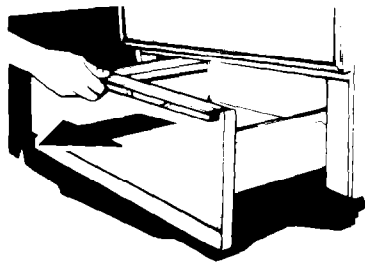

1. Pull drawer straight out to the first stop.

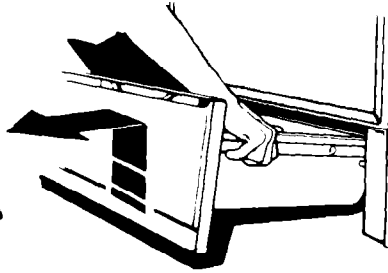

2. Lift front and pull out to the second stop.

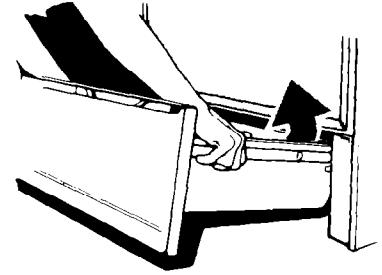

3. Lift back slightly and slide drawer all the way out.

REPLACING THE STORAGE DRAWER

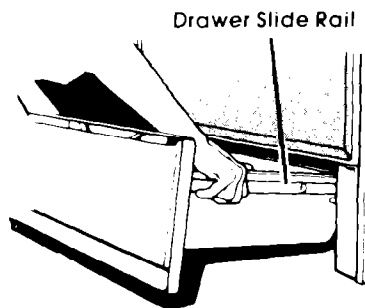

1. Fit ends of Drawer Slide Rails into drawer guides on both sides of opening.

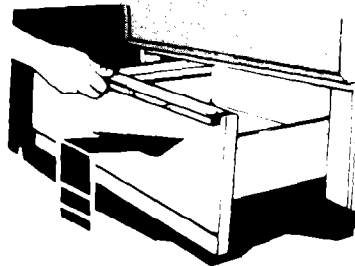

2. Lift drawer front and push in until metal stops (on drawer slide rails) clear white stops on drawer guides.

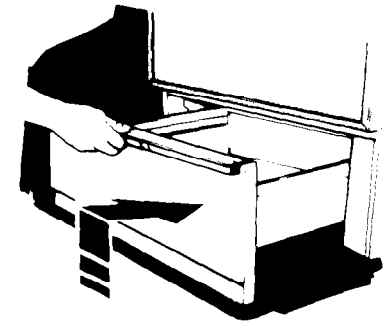

3. Lift drawer front to clear second stop and slide drawer closed.

THE LOWER OVEN SELF-CLEANING CYCLE

The lower oven self-cleaning cycle uses **very high heat** to burn away soil. Before you start, make sure you understand exactly how to use the cycle safely.

BEFORE YOU START

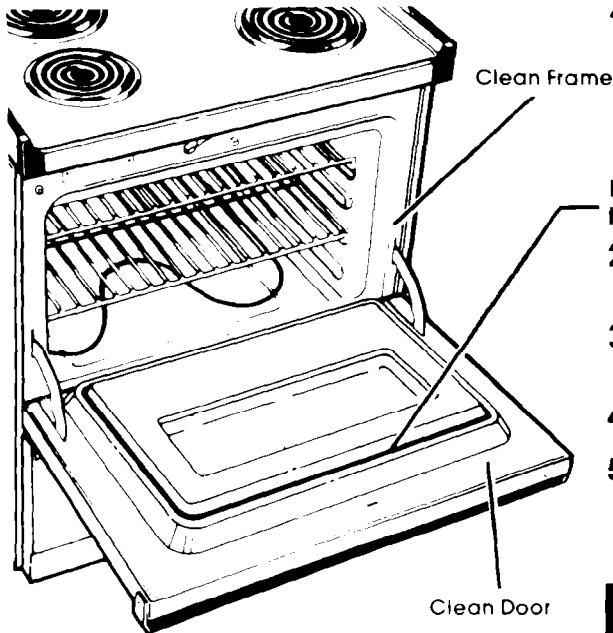

1. Clean areas that may not be cleaned during the cycle. Use hot water and detergent or a soapy steel-wool pad on...
 - the frame around the oven
 - the inside of the door, especially the part outside the oven seal

DO NOT try to clean the fiberglass seal. **DO NOT** move it or bend it.

2. Remove any pots or pans you may have stored in the oven. They can't stand the high heat.
3. Wipe out any loose soil or grease. This will help reduce smoke during the cleaning cycle.
4. Make sure the motor socket cover is closed if your oven has a rotisserie.
5. Put oven racks on the top two guides. **Put two reflector bowls upside down on each.** They should not touch each other or the oven walls.

Chrome trim rings must not be cleaned in the oven. They will become discolored. High heat will also discolor oven racks. See special tips on page 22.

SPECIAL CAUTIONS

DO NOT block the vent during the cleaning cycle. Air must move freely for best results.

DO NOT touch the oven during the cleaning cycle... it can burn you.

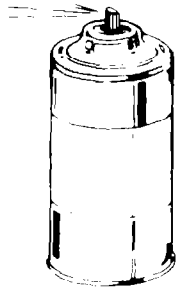

DO NOT use commercial oven cleaners in your oven. Damage to the porcelain finish may occur.

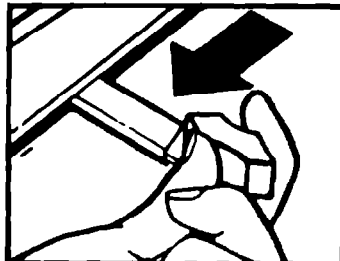

DO NOT force the Lock Lever. The lever is designed to stay locked until the oven is cool enough to safely open.

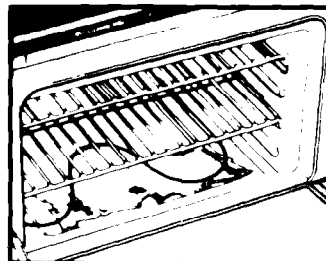

DO NOT use foil or other liners in the oven. During the cleaning cycle, foil can burn or melt.

SETTING THE CONTROLS

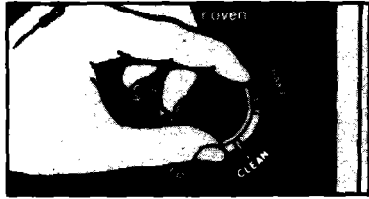

1. Set the Oven Selector to CLEAN.

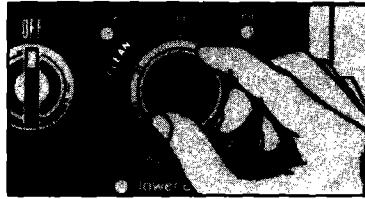

2. Set the Oven Temperature Control to CLEAN.



3. Make sure the clock and start and stop time dials all have the right time of day.



4. Push in the Stop Time Knob and turn the hand clockwise about two or three hours. (Two hours for light soil; three or more for heavier soil.)

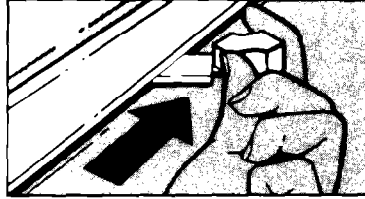

5. Move the Lock Lever *all the way to the right*. The Clean Light will come on only when the lever is all the way over.

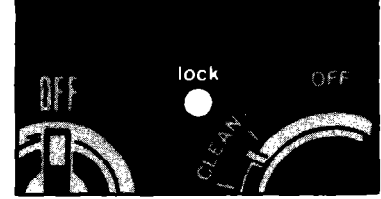

6. The Lock Light comes on when the oven gets above normal baking temperatures. The Lock Lever can't be moved when the Lock Light is on.

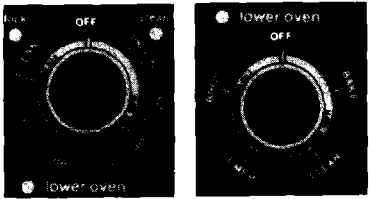

7. When the Lock Light goes off, turn the Oven Selector and Oven Temperature Control to OFF.

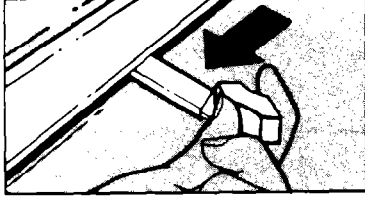

8. Move the Lock Lever back to the left. **Do not force it.** Wait until it will move easily. This turns off the Clean Light.



9. **After the oven is cool,** wipe off any residue or ash with a damp cloth. If needed, touch up spots with cleanser or soapy steel-wool pad.

DO NOT TOUCH THE RANGE DURING THE CLEANING CYCLE. IT CAN BURN YOU.

SPECIAL TIPS



1. Keep the kitchen well ventilated during the cleaning cycle to help get rid of normal heat odors and smoke



2. Clean the oven before it gets heavily soiled. Cleaning a very soiled oven takes longer and results in more smoke than usual.

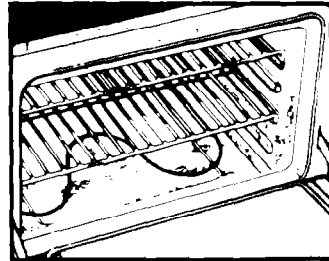

3. If the cleaning cycle doesn't get the oven as clean as you expected, the cycle may not have been set long enough. Set the cleaning time longer for heavier soil.

4. Oven racks lose their shine, discolor and become harder to slide on their guides when they are left in the oven during the cleaning cycle. To make them slide easier, polish the edges of the racks and rack guides with a soapy steel-wool pad, rinse well, and wipe on a thin coat of salad oil

5. To stop the cleaning cycle after it has started.

- Turn the Stop Time Knob clockwise until the hand points to the right time of day
- Turn the Oven Selector and Oven Temperature Control to OFF
- When the Lock Light turns off, move the Lock Lever back to the left. **DO NOT FORCE IT.** Wait until it moves easily.

HOW IT WORKS

During the self-cleaning cycle, the oven gets much hotter than it does for baking or broiling...approximately 875 F (468 C). This heat breaks up grease and soil, and burns it off.

The graph shows approximate temperatures and times during a self-cleaning cycle set for two hours.

SELF-CLEANING CYCLE – TWO HOUR SETTING
(Approximate Temperatures and Times)

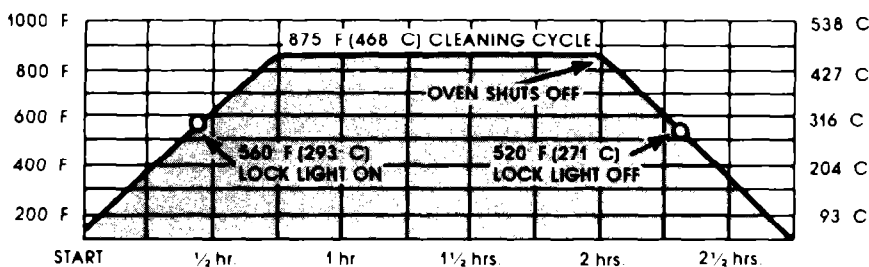

Notice that the heating stops when the two-hour setting is up, but that it takes a while longer for the oven to cool down enough to unlock.

CLEANING CHART

PART	WHAT TO USE	HOW TO CLEAN
Outside of range	Soft cloth, warm soapy water Nylon or plastic scouring pad for stubborn spots	<ul style="list-style-type: none"> ● Wipe off regularly when range is cool. ● Do not allow food containing acids (such as vinegar, tomato, lemon juice or milk) to remain on surface. Acids will remove the glossy finish. ● Do not use abrasive or harsh cleansers.
Surface units	No cleaning required	<ul style="list-style-type: none"> ● Spatters or spills will burn off. ● Do not immerse in water.
Porcelain-enamel reflector bowls	Automatic dishwasher or warm, soapy water Self-Cleaning Oven cycle	<ul style="list-style-type: none"> ● Wipe out excess spills. Wash with other cooking utensils for routine cleaning. ● Place upside down on oven racks in oven during Self-Cleaning Oven cycle.
Chrome trim rings	Automatic dishwasher or warm, soapy water or plastic scrubbing pad	<ul style="list-style-type: none"> ● Wash with other cooking utensils ● Do not place in Self-Cleaning Oven
Broiler pan and Grid	Warm, soapy water or soapy steel wool pads	<ul style="list-style-type: none"> ● Wash with other cooking utensils. ● Do not place in Self-Cleaning Oven
Control knobs and chrome rims	Warm, sudsy water and bristle brush	<ul style="list-style-type: none"> ● Wash, rinse and dry well. ● Do not soak.
Control panel	Warm, soapy water Commercial glass cleaner	<ul style="list-style-type: none"> ● Wash, rinse and dry with soft cloth. ● Follow directions with cleaner.
Oven racks	Self-Cleaning Oven cycle Warm, soapy water or soapy steel wool pads	<ul style="list-style-type: none"> ● Leave in oven during Self-Cleaning cycle ● Wash, rinse and dry. Use soapy steel wool pads for stubborn areas.
Lower oven door glass and outside only of microwave oven	Warm, soapy water or plastic scrubbing pad Commercial glass cleaner	<ul style="list-style-type: none"> ● Make certain oven is cool. Wash, rinse and dry well with soft cloth. ● Follow directions provided with cleaner.
Self-Cleaning Oven	For areas outside Self-Cleaning area use warm, soapy water or soapy steel wool pads	<ul style="list-style-type: none"> ● Clean before using Self-Cleaning cycle to prevent burn-on of soil. ● Follow directions given on page 21. "Using the Self-Cleaning Cycle." ● Do not use commercial oven cleaners.

Do not use foil to line the bottom of your Self-Cleaning Oven.

If you need service or assistance, we suggest you follow these four steps:

1. Before calling for assistance...

Performance problems often result from little things you can find and fix yourself without tools of any kind.

If nothing operates:

- Is the range correctly plugged into a live circuit with the proper voltage? (See **Installation Instructions**.)
- Have you checked the main fuse or circuit breaker box?

If the microwave oven will not run:

- Is the timer set?
- Is the Cook Power set?
- Is the door firmly closed?
- Did you push the START Button?
- Did you follow the directions on page 5 **exactly**?

If microwave cooking times seem too long:

- Is the electric supply to your home low or lower than normal? Your electric company can tell you if the line voltage is low.
- Is the Cook Power at the recommended setting?
- Are you allowing for more time when cooking more food at one time?

If the microwave oven turns off too soon or not soon enough when using the probe:

- Is at least 1/3 of the probe in the food?
- Is the probe tip in the center of the food?
- Is the probe touching bone or fat?
- Have you allowed roasts to stand for a few minutes after cooking?
- Is the probe plugged tightly into its socket?
- Is the Cook Power set where it should be?
- Is the Meal Sensor set at the end temperature you want?

If the lower oven will not operate:

- Is the Oven Selector turned to a setting (BAKE or BROIL, but not TIMED)?
- Is the Oven Temperature Control turned to a temperature setting?

If surface units will not operate:

- Have you checked main fuse or circuit breaker box?
- Are surface units plugged in all the way?
- Do the control knobs turn?

If surface unit knob or knobs will not turn:

- Did you push in before trying to turn?
- Is the spring replaced as shown on page 18?

If the Self-Cleaning cycle will not operate:

- Are the Oven Selector and the Oven Temperature Control set to "CLEAN?"
- Does the Start Time Dial show the correct time of day?
- Is the Stop Time Dial set ahead to the time you want the cleaning cycle to stop?
- Is the Lock Lever all the way to the right? (The Clean Light will come on.)

If cooking results aren't what you expect:

- Is the range level?
- Are you using pans recommended in the **Cooking Guide**?
- If baking, have you allowed 1 1/2 to 2 inches (4-5 cm) on all sides of the pans for air circulation?
- Does the oven temperature seem too low or too high? See page 13, "Adjusting the oven temperature control."
- Have you preheated the oven as the recipe calls for?
- Are the pans the size called for in the recipe?
- Are you following a tested recipe from a reliable source?
- Do the cooking utensils have smooth, flat bottoms?
- Do the cooking utensils fit the surface unit being used?

See the **Cooking Guide** for more information on cooking problems and how to solve them.

2. If you need assistance* ...

Call the Whirlpool COOL-LINE® service assistance telephone number. Dial free from:
Continental U.S. (800) 253-1304
Michigan (800) 632-2243
Alaska & Hawaii (800) 253-1124

and talk with one of our trained Consultants. The Consultant can instruct you in how to obtain satisfactory operation from your appliance or, if service is necessary, recommend a qualified service company in your area.

3. If you need service* ...



Whirlpool has a nationwide network of franchised TECH-CARE® Service Companies. TECH-CARE service technicians are trained to fulfill the product warranty and provide after-

warranty service, anywhere in the United States. To locate TECH-CARE service in your area, call our COOL-LINE service assistance telephone number (see Step 2) or look in your telephone directory Yellow Pages under:

APPLIANCES—HOUSEHOLD— MAJOR—SERVICE & REPAIR	OR	ELECTRICAL APPLIANCES— MAJOR—REPAIRING & PARTS
WHIRLPOOL APPLIANCES FRANCHISED TECH-CARE SERVICE		WHIRLPOOL APPLIANCES FRANCHISED TECH-CARE SERVICE
<i>SERVICE COMPANIES</i>		<i>SERVICE COMPANIES</i>
xy? SERVICE CO. 999 9999 123 Maple		xy? SERVICE CO. 999 9999 123 Maple
OR		
WASHING MACHINES, DRYERS & IRONERS—SERVICING		
WHIRLPOOL APPLIANCES FRANCHISED TECH-CARE SERVICE		
<i>SERVICE COMPANIES</i>		
xy? SERVICE CO. 999-9999 123 Maple		

4. If you have a problem* ...

Call our COOL-LINE service assistance telephone number (see Step 2) and talk with one of our Consultants, or if you prefer, write to:

Mr. Guy Turner, Vice President
Whirlpool Corporation
Administrative Center
2000 US-33 North
Benton Harbor, MI 49022

If you must call or write, please provide: model number, serial number, date of purchase, and a complete description of the problem. This information is needed in order to better respond to your request for assistance.

Notes



FSP is a registered trademark of Whirlpool Corporation for quality parts. Look for this symbol of quality whenever you need a replacement part for your Whirlpool appliance. FSP replacement parts will fit right and work right, because they are made to the same exacting specifications used to build every new Whirlpool appliance.



Benton Harbor, Michigan. Automatic Washers. Clothes Dryers. Freezers. Refrigerator-Freezers. Ice Makers. Dishwashers. Built-in Ovens and Surface Units. Ranges. Microwave Ovens. Compactors. Room Air Conditioners. Dehumidifiers. Central Heating and Air Conditioning Systems.