



ENGLISH

ESPAÑOL

# OWNER'S MANUAL

# ELECTRIC DOUBLE OVEN RANGE

Please read this guide thoroughly before operating  
and keep it handy for reference at all times.

LDE3015ST  
LDE3015SB  
LDE3015SW

# INTRODUCTION

## IMPORTANT SAFETY INFORMATION ....3-9

## SURFACE CONTROLS COOKING

Locations of Surface Elements and Controls .....	10
Hot Surface Indicator .....	11
Using the Element .....	11-12
Recommended Surface Cooking Setting .....	12
Tips to Protect the Glass/Ceramic Cooktop Surface ..	13
Glass/Ceramic Cooktop Surface .....	13
Cooking Areas .....	14
Using the Proper Cookware .....	14
Home Canning Tips .....	14

## PARTS AND FEATURES

Parts and features .....	15
Control panel features .....	16-17

## OPERATING INSTRUCTIONS

Clock.....	18
Minimum & Maximum Default Settings.....	18
Timer On/Off.....	19
Special Features of your Oven Control .....	20-21
Using Oven Racks.....	22
Oven Vent.....	22
Cooking Mode .....	23-39
- Bake.....	23
- Baking layer cakes.....	24
- Broil.....	25
- Recommended Broiling guide.....	26
- Timed cook.....	27
- Delayed Timed Cook.....	28
- Pizza .....	29
- Warm .....	30
- Proof .....	31
- Sabbath Mode.....	32
To turn on or off the oven light.....	33
Oven & Cooktop Lockout feature .....	33
Self Clean.....	34-36

## MAINTENANCE

Care & Cleaning .....	37-38
Cleaning the Glass/Ceramic Cooktop .....	38-39
Removing & Replacing the Lift-off Oven door .....	40-41
Door Care Instructions.....	41

## TROUBLESHOOTING

Before Calling for Service .....	42-45
----------------------------------	-------

## WARRANTY

Warranty for Customers in the U.S.A .....	46
---	----

## THANK YOU!

Congratulations on your purchase and welcome to the LG family. Your new LG Electric range combines precision cooking features with simple operation and stylish design. Follow the operating and care instructions in this manual and your range will provide you with many years of reliable service.

**Staple your receipt here.**

### ***Product Registration Information***

Model: \_\_\_\_\_

Serial Number: \_\_\_\_\_

Date of Purchase: \_\_\_\_\_

# IMPORTANT SAFETY INFORMATION

## READ ALL INSTRUCTIONS BEFORE USE

Read and follow all instructions before using your oven to prevent the risk of fire, electric shock, personal injury, or damage when using the range. This guide does not cover all possible conditions that may occur. Always contact your service agent or manufacturer about problems that you do not understand.



This is the safety alert symbol. This symbol alerts you to potential hazards that can kill or hurt you and others. All safety messages will follow the safety alert symbol and either the word **WARNING** or **CAUTION**. These words mean:

### **WARNING**

This symbol will alert you to hazards or unsafe practices which could cause serious bodily harm or death.

### **CAUTION**

This symbol will alert you to hazards or unsafe practices which could cause bodily injury or property damage.

## SAFETY PRECAUTIONS

### **WARNING**



• **DO NOT step or sit on the door. Install the Anti-Tip Bracket packed with range.**



- The range could be tipped and injury might result from spilled hot liquid, food, or the range itself.
- If the range is pulled away from the wall for cleaning, service, or any other reason, ensure that the anti-tip bracket is properly re-engaged when the range is pushed back against the wall.

• **To reduce the risk of tipping of the appliance, the appliance must be secured by properly installed Anti-Tip devices. To check if the devices are installed properly, remove (necessary part or parts) and verify that Anti-Tip devices are engaged.**

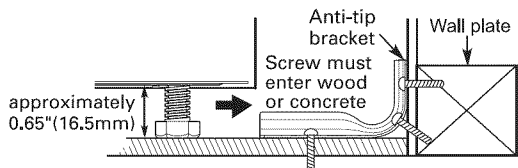

- This appliance is not intended for use by persons (including children) with reduced physical, sensory or mental capabilities, or lack of experience and knowledge, unless they have been given supervision or instruction concerning use of the appliance by a person responsible for their safety.
- To check that the anti-tip bracket is properly installed: Grasp the top rear edge of the range back guard and carefully attempt to tilt it forward. Verify that the anti-tip devices are engaged.
- Lower oven: Remove the lower oven door and visually inspect that the rear leveling leg is fully inserted into the anti-tip bracket.
- Refer to the installation manual for proper anti-tip bracket installation.
- Be certain your appliance is properly installed and grounded by a qualified technician.
- Do not repair or replace any part of the appliance unless specifically recommended in the manual.
- All other servicing should be referred to a qualified technician.
- Always disconnect power to appliance before servicing by unplugging, removing the fuse or switching off the circuit breaker.

# IMPORTANT SAFETY INFORMATION

## READ ALL INSTRUCTIONS BEFORE USE

### SAFETY PRECAUTIONS (cont')

- **DO NOT TOUCH HEATING ELEMENTS OR INTERIOR SURFACES OF OVEN.**

Heating elements may be hot even though they are dark in color. Interior surfaces of an oven become hot enough to cause burns. During and after use, do not touch or let clothing or other flammable materials contact heating elements or interior surfaces of oven until they have had sufficient time to cool. Other surfaces of the appliance may become hot enough to cause burns. Among these surfaces are oven vent openings and surfaces near these openings, oven doors, and windows of oven doors.

- **Use Care When Opening Door.**

Let hot air or steam escape before you remove or replace food in the oven.

- **Do Not Heat Unopened Food Containers.**

Build-up of pressure may cause container to burst and result in injury.

- **Be certain all packing materials are removed from the appliance before operating.**

Keep plastics, clothes, and paper away from parts of the appliance that may become hot.

- **DO NOT force the door open.**

This can damage the automatic door locking system. Use care when opening the oven door after the self cleaning cycle. Stand to the side of the oven when opening the door to allow hot air or steam to escape. The oven may still be VERY HOT.

- **DO NOT use a steel-wool pad.**

It will SCRATCH the surface.

- **DO NOT use harsh etching, abrasive cleaners or sharp metal scrapers to clean the oven door glass since they can scratch the surface.**

Scratches may cause the glass to shatter.

- **Be careful when removing and lifting the door.**

- **DO NOT lift the door by the handle.**

The door is very heavy.

- **DO NOT step or sit on the door.**

Install the anti-tip bracket packed with range.

- The range could be tipped and injury might result from spilled hot liquid, food, or the range itself.
- If the range is pulled away from the wall for cleaning, service, or any other reason, ensure that the anti-tip bracket is properly re-engage when the range is pushed back against the wall.

### WARNING

- **NEVER use your appliance for warming or heating the room.**
- **DO NOT use water on grease fires.** Should an oven fire occur, leave the oven door closed and turn the oven off. If the fire continues, throw baking soda on the fire or use a fire extinguisher.
- **Use dry pot holders only.** Moist or damp pot holders on hot surfaces may result in burns from steam. Do not let the pot holder touch hot heating elements. Do not use a towel or other bulky cloth.
- **Storage in or on appliance.** Flammable materials should not be stored in an oven or near surface elements.
- **Wear proper apparel.** Loose-fitting or hanging garments should never be worn while using the appliance.



# IMPORTANT SAFETY INFORMATION

## READ ALL INSTRUCTIONS BEFORE USE

### ELECTRICAL SAFETY

- **Protective Liners.** Do not use aluminum foil or any other material to line the oven bottoms. Improper installation of these liners may result in a risk of electric shock or fire.
- **Do Not** allow aluminum foil or meat probe to contact heating elements.

**⚠ WARNING**

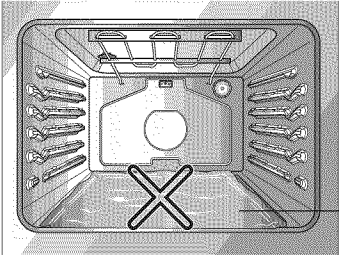

Aluminum foil

- **DO NOT** place aluminum foil directly on the oven bottom.

- **Before replacing your oven light bulb, switch off the electrical power to the oven at the main fuse or circuit breaker panel.**  
Failure to do so can result in severe personal injury, death, or electrical shock.
- **DO NOT** line the oven walls, racks, bottom, or any other part of the oven with aluminum foil or any other material.  
Doing so will disrupt heat distribution, produce poor baking results and cause permanent damage to the oven interior (aluminum foil will melt to the interior surface of the oven.)

**⚠ WARNING**

- **Make sure the POWER OFF** before removing or replace some electrical parts. (Especially a bulb in the oven lights)  
- Failure to do so can result in severe personal injury, death, or electrical shock.

### PAN PLACEMENT

**⚠ WARNING**

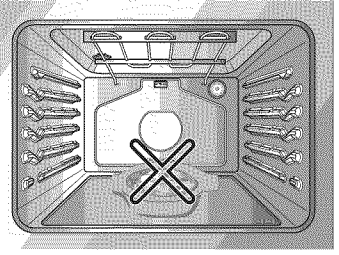

- **Do not** place food or cookware on the bottom of the oven cavity.

Doing so will cause permanent damage to the oven bottom finish.

- **Never** place plastics, paper, canned foods or combustible material in the oven.
- **When cooking food in the oven always use a baking sheet or pan with 4 raised sides.** This will prevent food from sliding off.

### DEEP FAT FRYERS

- Use extreme caution when moving or disposing of hot grease.

# IMPORTANT SAFETY INFORMATION

## READ ALL INSTRUCTIONS BEFORE USE

### SURFACE COOKING UNITS

- **Use Proper Pan Sizes.** This appliance is equipped with one or more surface units of different size. Select utensils having flat bottoms large enough to cover the surface unit heating element.  
The use of undersized utensils will expose a portion of the heating element to direct contact and may result in ignition of clothing. Proper relationship of utensil to burner will also improve efficiency.
- **Never Leave Surface Units Unattended at High Heat Settings.** Boil overs cause smoking and greasy spillovers that may ignite.
- **Glazed Cooking Utensils.** Only certain types of glass, glass/ceramic, ceramic, earthenware, or other glazed utensils are suitable for range-top service without breaking due to the sudden change in temperature.
- **Utensil Handles Should Be Turned Inward and Not Extend Over Adjacent Surface Units.** To reduce the risk of burns, ignition of flammable materials, and spillage due to unintentional contact with the utensil, the handle of a utensil should be positioned so that it is turned inward, and does not extend over adjacent surface units.
- Be sure you know which control pads operate each surface unit. Make sure you turned on the correct surface unit.

### SAFETY DURING USE

- **Oven Racks.** Always place oven racks in desired position while oven is cool.
- **Always use pot holders or oven mitts when removing food from the oven or Center Warming element as cookware and plates will be hot.** You can be burned because cookware and plates will be hot.
- **Always use an oven mitt to remove the temperature probe after cooking.**
- **Use caution with the TIMED BAKE or DELAYED TIMED BAKE features. Use the automatic timer when cooking cured or frozen meats and most fruits and vegetables. Foods that can easily spoil, such as milk, eggs, fish, meat or poultry, should be chilled in the refrigerator first. Even when chilled, they should not stand in the oven for more than 1 hour before cooking begins, and should be removed promptly when cooking is completed.**  
Eating spoiled food can result in sickness from food poisoning.
- **Should an oven fire occur, leave the oven door closed and turn the oven off. If the fire continues, throw baking soda on the fire or use a fire extinguisher.**
- **DO NOT put water or flour on the fire.** Flour may be explosive and water can cause a grease fire to spread and cause personal injury.
- **DO NOT use the broiler pan without the grid. DO NOT cover the grid with aluminum foil.**
- **Do not use plastic to cover food.** Plastic can melt onto oven surfaces. Use foil or oven resistant lids only.
- **If the oven is heavily soiled with oil, self clean the oven before using the oven again. It could cause a risk of fire.**  
Wipe up heavy soil on the oven bottom before self clean. It requires longer cleaning cycles and produces more smoke.

# IMPORTANT SAFETY INFORMATION

## READ ALL INSTRUCTIONS BEFORE USE

### CHILD SAFETY

#### **WARNING**

- Children should be kept away from the oven.
- Accessory parts will become hot when the broiler is in use.

#### **CAUTION**

- **DO NOT** leave small children unattended near the appliance.  
During the self clean cycle, the outside of the oven can become very hot to the touch.

#### **CAUTION**

- **NEVER** leave children alone or unsupervised near the appliance when it is in use or is still hot. Children should never be allowed to sit or stand on any part of the appliance as they could be injured or burned.
- **NEVER** store items of interest to children in cabinets above an appliance. Children climbing on the appliance or on the appliance door to reach items could be seriously injured.
- Children must be taught that the appliance and utensils in it can be hot. Let hot utensils cool in a safe place, out of reach of small children. Children should be taught that an appliance is not a toy. Children should not be allowed to play with controls or other parts of the appliance.

### GLASS/CERAMIC COOKING SURFACES

#### **DO NOT TOUCH SURFACE UNITS OR AREAS NEAR UNITS.**

Surface units may be hot even though they are dark in color. Areas near surface units may become hot enough to cause burns. During and after use, do not touch, or let clothing or other flammable materials contact surface units or areas near units until they have had sufficient time to cool. This includes the cooktop and the area above the oven door.

- **Do Not Cook on a Broken Cooktop.** If the cooktop should break, cleaning solutions and spillovers may penetrate the broken cooktop and create a risk of electric shock. Contact a qualified technician immediately.

- **Clean Cooktop With Caution.** Do not use sponges or cloth to wipe spills on a hot cooking area. Use a proper metal scraper.
- **DO NOT use the glass cooktop** surface as a cutting board.
- **DO NOT place or store** items that can melt or catch fire on the glass cooktop, even when it is not being used.
- **Always turn the surface units on after placing cookware.**
- **DO NOT store** heavy items above the cooktop surface that could fall and damage it.

# IMPORTANT SAFETY INFORMATION

## READ ALL INSTRUCTIONS BEFORE USE

### GLASS/CERAMIC COOKING SURFACES (cont')

- **DO NOT place** aluminum foil or plastic items such as salt and pepper shakers, spoon holders, or plastic wrappings or any other material on the range when it is in use.
- Make sure you turned on the correct surface unit.
- **NEVER cook directly on the glass.** Always use cookware.
- **Always place the pan in the center of the surface unit you are cooking on.**  
**NEVER leave surface units unattended at high heat setting.**
  - Boil overs cause smoking and greasy spillovers that may catch on fire.
- **Always turn the surface units off before removing cookware.**
- **DO NOT use plastic wrap to cover food.**
  - Plastic may melt onto the surface and be very difficult to remove.
- **DO NOT touch surface units until it has cooled down.**
- The surface elements may still be hot and burns may occur if the glass surface is touched before it has cooled down sufficiently.
- Immediately clean the spills on cooking area to prevent a tough cleaning chore later.
- If cabinet storage is provided directly above cooking surface, limit it to items that are infrequently used and can be safely stored in an area subjected to heat. Temperatures may be unsafe for items such as volatile liquids, cleaners or aerosol sprays.
- When warming foods do not use containers that seal. Allow venting for heated air to escape
- **DO NOT use a steel-wool pad.**
  - It will scratch the surface.
- **DO NOT use scrub pads or abrasive cleaning pads.**
  - They may damage your glass cooktop surface.
- **Cookware with rough or bottoms can mark or scratch the cooktop surface.**
- **Do not slide anything metal or glass across the cooktop.**
- **Do not use cookware with dirt or dirt built-up on the bottom.**

# IMPORTANT SAFETY INFORMATION

## READ ALL INSTRUCTIONS BEFORE USE

### SAFETY WHEN CLEANING

- **Open window or turn on a ventilation fan or hood before self cleaning.**
- **Do Not Use Oven Cleaners.** No commercial oven cleaner or oven liner protective coating of any kind should be used in or around any part of the oven.
- **Before self cleaning the oven.** Remove broiler pan, all oven racks, meat probe and any other utensils from the oven cavity.
- **Never keep pet birds in the kitchen.** The health of birds is extremely sensitive to the fumes released during an oven self clean cycle. Fumes may be harmful or fatal to birds. Move birds to well-ventilated room.
- Clean in the self clean cycle only parts listed in this manual. Before using the self clean feature of the oven, remove the broiler pan and any utensils of foods from the oven.
- It is normal for the cooktop of the range to become hot during a self clean cycle. Therefore, touching the cooktop during a clean cycle should be avoided.
- **Important Instruction.** In the event the self clean error code F is displayed, and three long beeps sound, the oven is malfunctioning in the self clean mode. Switch off the electrical power to the main fuse or breaker and have the unit serviced by a qualified technician.
- **Make sure oven lights are cool before cleaning.**

# SURFACE CONTROLS COOKING

## LOCATIONS OF SURFACE ELEMENTS AND CONTROLS

The radiant surface elements are located on the cooktop as below. The radiant control pad locations are correlative to Radiant surface elements on the cooktop as shown below.

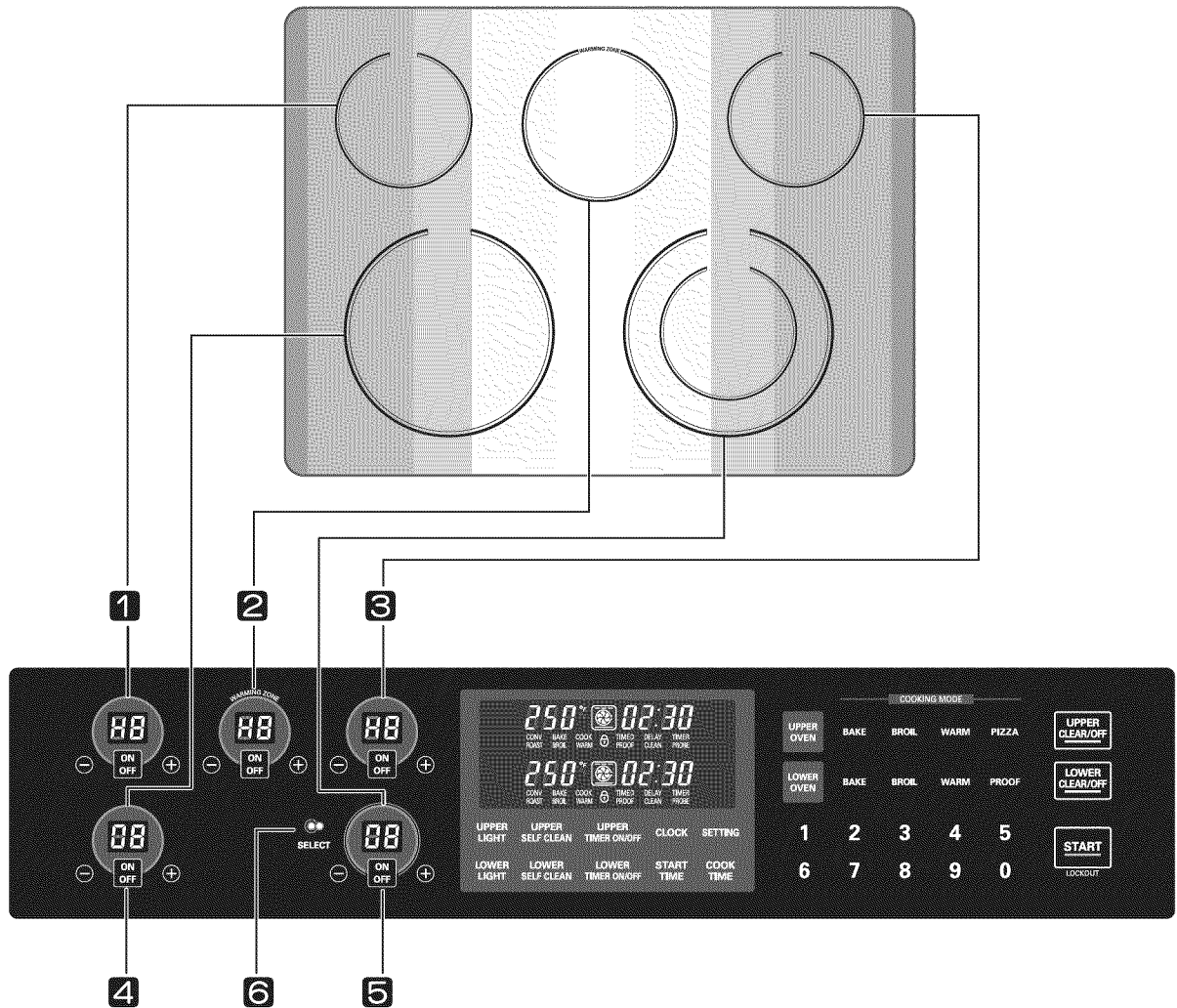

- 1 LEFT REAR ELEMENT INDICATOR**  
(Single element)
- 2 WARMING ZONE ELEMENT INDICATOR**
- 3 RIGHT REAR ELEMENT INDICATOR**  
(Single element)
- 4 LEFT FRONT ELEMENT INDICATOR**  
(Single element)
- 5 RIGHT FRONT ELEMENT INDICATOR**  
(Double element)
- 6 SELECT INDICATOR**
  - Use to select single or double elements.
  - For LEFT FRONT & RIGHT FRONT ELEMENTS.

### HS(Hot Surface) MESSAGE

- Activated when the unit is hot to the touch after it is turned off.
- Activated during Self Clean Cycle.
- Activated even after the unit is turned off.
- Displayed until the unit has cooled down to approximately 150°F/66°C.

### PF(Power Failure) MESSAGE

The PF message will appear whenever there has been a power interruption to the appliance. To clear the PF message press ON/OFF control pad to reset and be sure to reset the clock with the correct time of day.

# SURFACE CONTROLS COOKING

## HOT SURFACE INDICATOR



The display will Flash HS(Hot Surface). When the surface is too hot to touch because of the heating element. It will remain on after the element is turned off and the surface has cooled to approximately 150 deg F.

### CAUTION

- **DO NOT touch surface elements until it has cooled down sufficiently.**
- The surface elements may still be hot and burns may occur.

### CAUTION

- **SURFACE ELEMENT CYCLES**
- When cooking on the surface elements it is possible for the element to cycle on and off during cooking. This will happen more frequently when a lower power is selected however it can also occur on higher settings as well.

## USING THE ELEMENT

To turn on a **SINGLE surface unit:**  
(Left Rear, Right Rear, Left Front)



- 1 Press **ON/OFF** for the desired element position. The display will flash . (If no further pads are pressed within 10 seconds, the display will disappear.)



- 2 Press **+** once to turn on the power level **Hi** or **-** once to **Lo**.



- 3 Use the **- / +** to choose the desired power setting. **- / +** is continuously accessible. (Adjustable at any time while the element is ON.)



- 4 To turn off the unit after cooking, press **ON/OFF** once.

### NOTE:

- Each time a pad is pressed a beep will sound.
- The power level decreases or increases by 0.5 from **9.0** through **3.0**. (by **0.2** from **3.0** through **1.0**)
- **Lo** is the lowest power level available.

### NOTE:

To scroll through the power levels quickly press and hold the **-** or **+** key pads until the power level desired is reached.

### CAUTION

- **NEVER leave food unattended at high or medium-high setting.**
- Boil overs can cause smoke.  
Greasy spillovers may catch on fire.

# SURFACE CONTROLS COOKING

## USING THE ELEMENT (cont')

To turn on a **DOUBLE** surface unit: **(Right Front)**



There are two double elements located in the left & right front position. This allows you to change the size of element.



- 1 Press **ON/OFF**. The display will flash . (If no further pads are pressed within 10 seconds, the display will disappear.)



- 2 Press **SELECT** for double or single element function. First touch is the inner element. Second touch is both inner and outer elements. The light bars above **SELECT** indicates single or double elements.



- 3 Press **+** once to turn on the power level **Hi** or **-** once for **Lo**.



- 4 Use the **- / +** to choose the desired power setting. **- / +** is continuously accessible. (Adjustable at any time while the element is ON.)



- 5 To turn off the unit after cooking, press **ON/OFF** once.

Heating with inner (smaller) element only

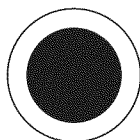

A

Heating with both elements together

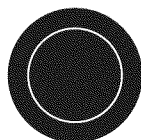

B

### NOTE:

- Each time a pad is pressed a beep will sound.
- The power level decreases or increases by **0.5** from **9.0** through **3.0**. (by **0.2** from **3.0** through **1.0**)
- Lo is the lowest power level available.

### NOTE:

To scroll through the power levels quickly press and hold the **-** or **+** key pads until the power level desired is reached.

To turn on the **Warming Zone: (Center)**



- 1 Press **ON/OFF** at the warming zone control position. The warming zone indicator light will flash.
- 2 Press **+** once to activate the **Hi** power level or **-** to activate the **Lo** power level. Power level sequence is from **- Lo, 2, 3, 4, Hi** or from **+ Hi, 4, 3, 2, Lo**.
- 3 Use the **- / +** to choose the desired power setting.
- 4 To turn off the unit when the food is ready to serve, press **ON/OFF** once.

## CAUTION

- Use only cookware and dishes recommended as safe for oven and cooktop use.
- Always use oven mitts when removing food from the warming center as cookware and plates will be hot.
- When warming foods do not use containers that seal. Allow venting for heated air to escape.
- **DO NOT use plastic wrap to cover foods.**
  - Plastic may melt onto the surface and be very difficult to clean.
- Food should be kept in its container and covered with a lid or aluminum foil to maintain food quality.
- **DO NOT warm food on the warming zone for more than 2 hours.**
  - Placing uncooked or cold food on the warming zone could result in foodborne illness.

## RECOMMENDED SURFACE COOKING SETTING

Element	Lv	Recommended Use	Element	Lv	Type of Cooking
Single Double	8.5-Hi	<ul style="list-style-type: none"> <li>• Bring liquid to a boil</li> <li>• Start cooking</li> </ul>	Warm	Hi	<ul style="list-style-type: none"> <li>• Fried Foods</li> <li>• Hot Beverage</li> <li>• Soups (Liquid)</li> </ul>
	5.5-8.0	<ul style="list-style-type: none"> <li>• Hold a rapid boil, frying, deep fat fry</li> <li>• Quickly brown or sear food</li> </ul>		2-4	<ul style="list-style-type: none"> <li>• Dinner Plate with Food</li> <li>• Sauces</li> <li>• Soups (Cream)</li> <li>• Stew</li> <li>• Vegetables</li> <li>• Meats</li> </ul>
	3.5-5.0	<ul style="list-style-type: none"> <li>• Maintain a slow boil</li> <li>• Fry or saute foods</li> <li>• Cook soups, sauces and gravies</li> </ul>			
	2.2-3.0	<ul style="list-style-type: none"> <li>• Stew or steam food</li> <li>• Simmer</li> </ul>			
	LO-2.0	<ul style="list-style-type: none"> <li>• Keep food warm</li> <li>• Melt chocolate or butter</li> </ul>		Lo	<ul style="list-style-type: none"> <li>• Bread/Pastries</li> <li>• Gravies</li> <li>• Casseroles</li> <li>• Eggs</li> </ul>



# SURFACE CONTROLS COOKING

## TIPS TO PROTECT THE GLASS/CERAMIC COOKTOP SURFACE

### **Cleaning**

(See pages 37~39 for more information).

Before first use, clean the cooktop.

Clean your cooktop daily or after each use. This will keep your cooktop looking good and can prevent damage.

If a spillover occurs while cooking, immediately clean the spill from the cooking area while it is hot to prevent a tough cleaning. Using extreme care, wipe spill with a clean dry towel.

**Do not** allow spills to remain on the cooking area or the cooktop trim for a long period of time.

**Do not** use abrasive cleansing powders or scouring pads that can scratch the cooktop.

**Do not** use chlorine bleach, ammonia, or other cleansers not specifically recommended for use on glass-ceramic.

### **To Prevent Other Damages**

Do not allow plastic, sugar, or foods with high sugar content to melt onto the hot cooktop. Should this happen, clean immediately. (See Cleaning pages 37~39.)

**Do not** let a pan boil dry as this will damage the surface and pan.

**Do not** use cooktop as a work surface or cutting board.

**Do not** cook food directly on the surface.

### **To Prevent Marks and Scratches**

Do not use glass pans. They may scratch the surface.

**Do not** place a trivet or wok ring between the surface and pan. These items can mark or scratch the top.

Do not slide aluminum pans across a hot surface. The pans may leave marks which need to be removed promptly.

(See Cleaning pages 37~39).

Make sure the surface and the pan bottom are clean before turning on to prevent scratches.

To prevent scratching or damaging to the glass-ceramic top, do not leave sugar, salt, or fats on the cooking area. Wipe the cooktop surface with a clean cloth or paper towel before using.

**Do not** slide heavy metal pans across the surface since these may scratch.

### **To Prevent Stains**

**Do not** use a soiled dish cloth or sponge to clean the cooktop surface. A film will remain which may cause stains on the cooking surface after the area is heated.

Continuously cooking on a soiled surface will result in result in a permanent stain.

## GLASS/CERAMIC COOKTOP SURFACE

### **Cooktop Surface Notes:**

- **Cooktop may emit light smoke and odor** the first few times the cooktop is used. This is normal.
- **Glass cooktops retain heat for a period of time after the elements are turned off.** Turn the elements off a few minutes before food is completely cooked and use the retained heat to complete cooking. When the hot surface light turns off, the cooking area will cool down enough to touch. Because of the way the cooktop retains heat, the elements will not respond to changes in the settings as quickly as coil elements.
- In the event of a potential boilover, remove the pan from the cooking surface.
- **Do not attempt to lift the cooktop.**
- The smoothtop surface may appear discolored when it is hot. This is normal and will disappear when the surface cools.

# SURFACE CONTROLS COOKING

## COOKING AREAS

The cooking areas on your range are identified by permanent circles on the glass cooktop surface. For the most efficient cooking, fit the pan size to the element size.

**Pans should not extend more than 1/2 to 1-inch beyond the cooking area.**

When a control is turned on, a glow can be seen through the glass cooktop surface. **The element will cycle on and off to maintain the preset heat setting, even on Hi.**

For more information on cookware, refer to Cookware Recommendations.

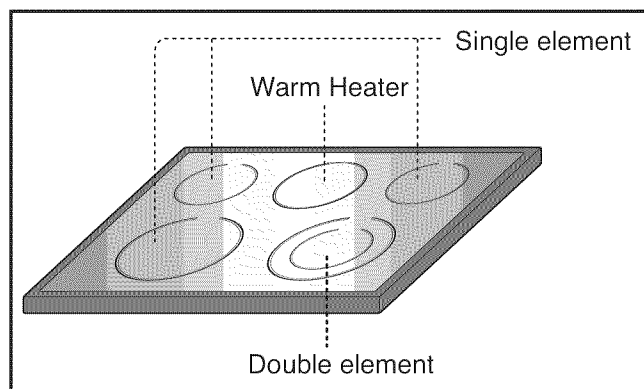

## USING THE PROPER COOKWARE

Using the right cookware can prevent many problems, such as food taking longer to cook or achieving inconsistent results. Proper pans will reduce cooking times and cook food more evenly. Stainless steel is recommended.

**Check pans for flat bottoms by using a straight edge or ruler**

- ❶ Place a ruler across the bottom of the pan.
- ❷ Hold it up to the light.
- ❸ No light should be visible under the ruler.

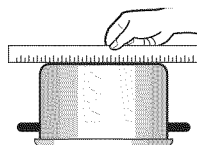

### NOTE:

- Do not use a small pan on a large element. Not only does this waste energy, but it can also result in spillovers burning onto the cooking area which requires extra cleaning.
- Do not use non-flat specialty items that are oversized or uneven such as round bottom woks, rippled bottom, and/or oversized canners and griddles.
- Do not use foil or foil-type containers. Foil may melt onto the glass. If metal melts on the cooktop, do not use. Call an authorized Service agent.

Recommended	Incorrect
Flat bottom and straight sides.	Curved, grooved, or warped pan bottoms. Pans with uneven bottoms do not cook efficiently and sometimes may not boil liquid.
Heavy-gauge pans.	Very thin-gauge metal or glass pans.
Pan sizes match the amount of food to be prepared and the size of the surface element.	Pans are smaller or larger than the element.
Weight of handle does not tilt pan. Pan is well balanced.	Cookware with loose or broken handles. Heavy handles that tilt the pan.
Tight-fitting lids.	Loose-fitting lids.
Flat bottom woks.	Woks with a ring-stand bottom.

## HOME CANNING TIPS

**Be sure the canner is centered over the surface unit. Make sure the canner is flat on the bottom.**

The base must not be more than 1 inch larger than the element. Use of water bath canners with rippled bottoms may extend the time required to bring the water to a boil and cooktops may be damaged.

Some canners are designed with smaller bases for use on smooth top surfaces.

Use the high heat setting only until the water comes to a boil or pressure is reached in the canner.

Reduce to the lowest heat setting that maintains the boil, or pressure. If the heat is not turned down, the cooktop may be damaged.

## PARTS AND FEATURES

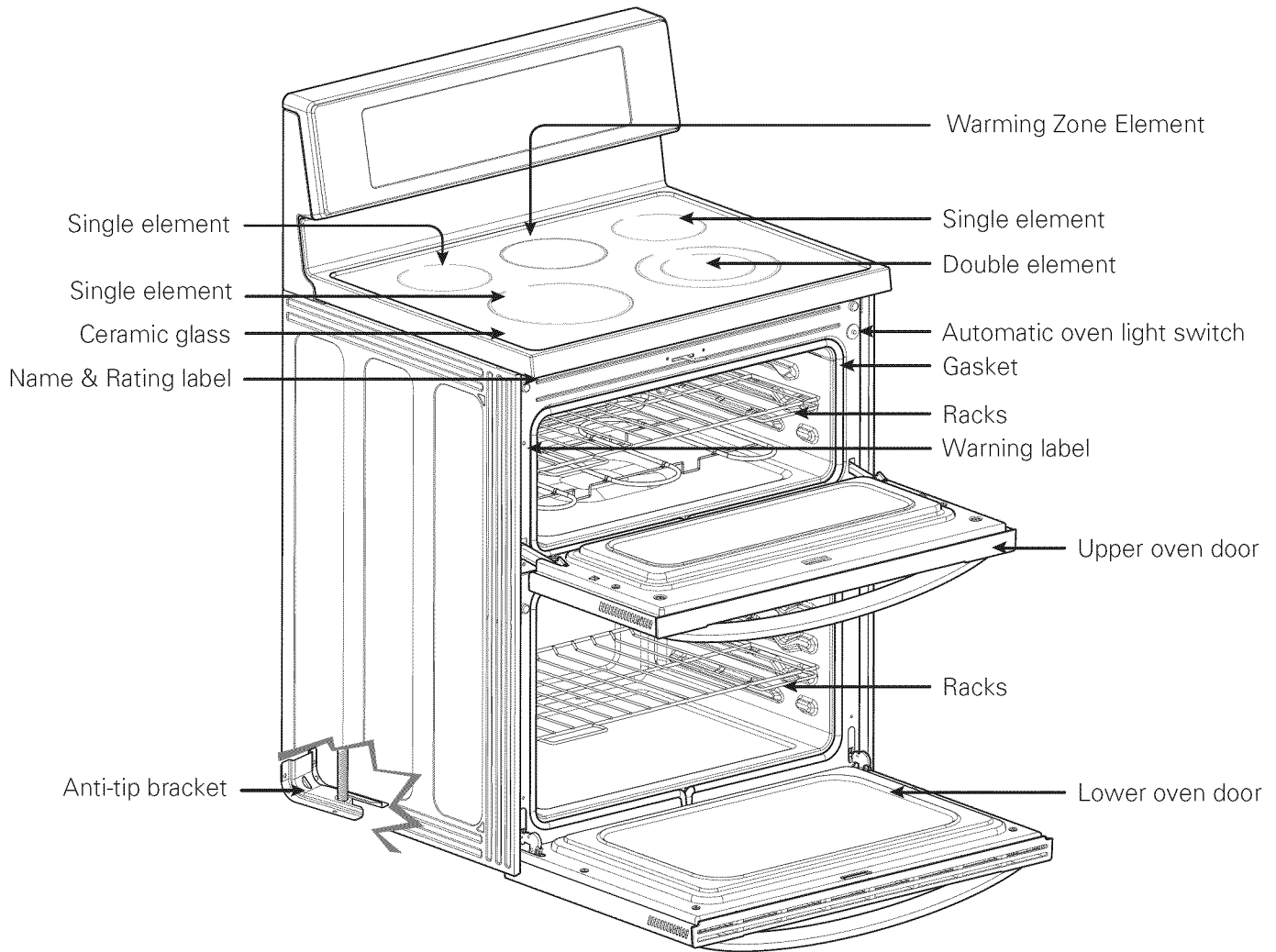

**Accessories for installation**

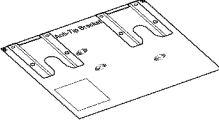
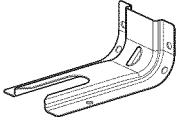
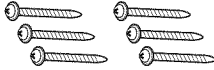
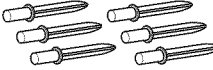
			
Template	Anti-tip bracket	Screws (6 ea)	Anchors (6 ea)

**Accessories for cooking**

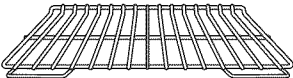
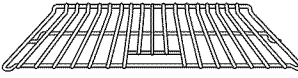
	
Standard rack(2ea)	Offset rack(1ea)

**Accessories for maintenance**

	
Cleaner	Cleaning pad

# PARTS AND FEATURES

## CONTROL PANEL FEATURES

**READ THE INSTRUCTIONS CAREFULLY BEFORE USING THE OVEN.** For satisfactory use of your oven, become familiar with the various features and functions of the oven as described below. **Detailed instructions for each feature and function are listed in this Owner's Manual.**

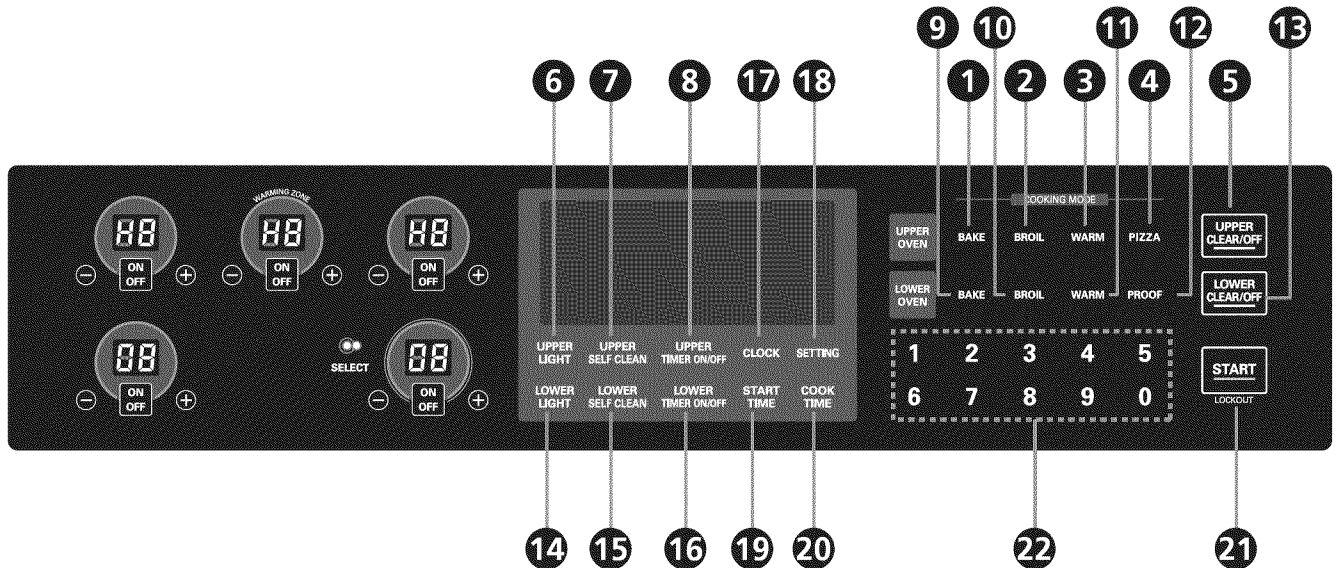

### UPPER OVEN

- 1 BAKE** : Use to select the Bake function of the upper oven.
- 2 BROIL** : Use to select the Broil function of the upper oven.
- 3 WARM** : Use to select the Warm function of the upper oven.
- 4 PIZZA** : Use to select the Pizza function of the upper oven.
- 5 UPPER CLEAR OFF** : Use to stop cooking, cancel settings of the upper oven.
- 6 UPPER LIGHT** : Use to turn the Oven lights of the upper oven on and off.
- 7 UPPER SELF CLEAN**: Use to select the Self Clean of the upper oven.
- 8 UPPER TIMER ON/OFF**: Use to set or cancel the timer of the upper oven.

### LOWER OVEN

- 9 BAKE** : Use to select the Bake function of the lower oven.
- 10 BROIL** : Use to select the Broil function of the lower oven.
- 11 WARM** : Use to select the Warm function of the lower oven.
- 12 PROOF** : Use to select the Proof function of the lower oven.
- 13 LOWER CLEAR OFF** : Use to stop cooking, cancel settings of the lower oven.
- 14 LOWER LIGHT** : Use to turn the Oven lights of the lower oven on and off.
- 15 LOWER SELF CLEAN** : Use to select the Self Clean of the lower oven.
- 16 LOWER TIMER ON/OFF** : Use to set or cancel the timer of the lower oven.

## CONTROL PANEL FEATURES (cont')

### COMMON FUNCTION

- 17** **CLOCK** : Use to set the time of day.
- 18** **SETTING** : Use to set the time of day.
- 19** **START TIME** : Use to set delay time. (Bake, Self clean only)
- 20** **COOK TIME** : Use to set the length of the cook time. (Bake only)
- 21** **START** : Use to START all functions in the oven. To activate LOCKOUT press and hold for 3 seconds.
- 22** **NUMBER PADS** : Use to enter a temperature and all times.

### **NOTE:**

**If F- and a number appear in the display and the oven control signals, this indicates a function error code.**

See page 42.

Touch the **UPPER** or **LOWER CLEAR OFF** pad.

Allow the oven to cool for one hour. Put the oven back into operation.

If the function error code repeats, disconnect the power to the oven and call for service.

**If your oven was set for a timed oven operation and a power outage occurred, the clock and all programmed functions must be reset.**

**The time of day will flash in the display when there has been a power outage.**

# OPERATING INSTRUCTIONS

## CLOCK

### How to set the Clock

The clock must be set to the correct time of day for the automatic oven timing functions to work properly. The time of day cannot be changed during a timed baking or Self Clean cycle.

#### CLOCK

- 1 Touch the **CLOCK** pad once to set.

#### 1 2 3

- 2 Touch the **number** pad to enter the time. Touch the number pad with the correct time of day. For example, to set 12:34, touch the number pad **1**, **2**, **3** and **4**. If number pad is not touched within 30 seconds after you touch the **CLOCK** pad, the display reverts to the original setting. If this happens, touch the **CLOCK** pad and reenter the time of day.



- 3 Touch **START**. This enters the time and starts the clock.

To check the time of day when the display is showing other information, simply touch the **CLOCK** pad.

### How to change hour mode on Clock (12HR or 24HR)

Your control is set to use a 12-hour clock. If you would prefer to have a 24-hour time clock, follow the steps below.

#### SETTING

- 1 Touch the **SETTING** pad 8 times. Display will change into **CLO**.

#### 1 2

- 2 Touch the number **1** pad for 12-hour, **2** pad for 24-hour.



- 3 Touch the **START** pad to accept the desired change.

### Power outage



If a flashing time is in the display, you have experienced a power failure. Reset the clock. Touch the **CLOCK** pad once to reset. Enter the correct time of day by touching the appropriate number pads. Touch the **START** pad.

## MINIMUM & MAXIMUM DEFAULT SETTINGS

All of the features listed have minimum and maximum time or temperature settings that may be entered into the control. An entry acceptance beep will sound each time a control pad is touched.

An entry error tone (2 short melody) will sound if the entry of the temperature or time is below the minimum or above the maximum settings for the feature.

FEATURE		MIN. TEMP. / TIME	MAX. TEMP. / TIME	Default
CLOCK TIME	12 Hr.	1:00 Hr. / Min.	11:59 Hr. / Min.	
	24 Hr.	0:00 Hr. / Min.	23:59 Hr. / Min.	
KITCHEN TIMER	12 Hr.	0:01 Min.	11:59 Hr. / Min.	
	24 Hr.	0:01 Min.	11:59 Hr. / Min.	
COOKING TIME	12 Hr.	0:01 Min.	11:59 Hr. / Min.	
	24 Hr.	0:01 Min.	11:59 Hr. / Min.	
BROIL TEMP.		Lo - 400°F / 204°C	Hi - 550°F / 288°C	3 Hr.
BAKE TEMP.		170°F / 77°C	550°F / 288°C	12 Hr.
PROOF				12 Hr.
WARM			170°F / 75°C, 3 hours	3 Hr.
SELF CLEAN		3 Hr.	5 Hr.	4 Hr.

## TIMER ON/OFF

The **UPPER** or **LOWER TIMER ON/OFF** serves as an extra timer in the kitchen that will beep when the set time has run out. It does not start or stop cooking.

The **UPPER** or **LOWER TIMER ON/OFF** feature can be used during any of the other oven control functions. The **UPPER** and **LOWER TIMER** can be operated independently of each other.

### To set the Timer

(example to set 5 minutes):

**UPPER  
TIMER ON/OFF**

or

**LOWER  
TIMER ON/OFF**

- 1 Touch **UPPER** or **LOWER TIMER ON/OFF** twice.  
**0:00** and **HR** inside will appear and **TIMER** will flash in the display.



**5**

- 2 Touch **5** in the number pad.  
You can see **0:05** in the display



**UPPER  
TIMER ON/OFF**

or

**LOWER  
TIMER ON/OFF**

- 3 Touch **TIMER** to start the Timer.  
The time will count down with 5:00 and the time will show in the display.



#### NOTE:

If **UPPER** or **LOWER TIMER ON/OFF** is not touched, the timer will return to the time of day.

**UPPER  
TIMER ON/OFF**

or

**LOWER  
TIMER ON/OFF**

- 4 When the set time has run out, **End** will show in the display. The indicator tones will sound every 15 seconds until **UPPER** or **LOWER TIMER ON/OFF** is touched.

#### NOTE:

If the remaining time is not in the display, recall the remaining time by touching the **UPPER** or **LOWER TIMER ON/OFF**.

#### NOTE:

- If you touch **UPPER** or **LOWER TIMER ON/OFF** once, it allows you to set the time in seconds.  
(for example: if you touch 50, it means 50 seconds)



- If you touch **UPPER** or **LOWER TIMER ON/OFF** twice, it allows you to set the time in minutes.  
(for example: if you touch 5, it means 5 minutes)



### To cancel the Timer before the set time has run out:

**UPPER  
TIMER ON/OFF**

or

**LOWER  
TIMER ON/OFF**

- 1 Touch **UPPER** or **LOWER TIMER ON/OFF** once.  
The display will return to the time of day.

# OPERATING INSTRUCTIONS

## SPECIAL FEATURES OF YOUR OVEN CONTROL

Your new touch pad control has additional features that you may choose to use. The following pages describe these features and how you may activate them.

The special feature modes can only be activated while the display is showing the time of day.

They remain in the control's memory until the steps are repeated.

When the display shows your choice, touch the **START** pad. The special features will remain in memory after a power failure.

### *How to adjust the oven thermostat (For both the Upper & Lower ovens)*

You may find that your new oven cooks differently than the one it replaced. Use your new oven for a few weeks to become more familiar with it. If you still think your new oven is too hot or too cold, you can adjust the thermostat yourself.

Do not use thermometers, such as those found in grocery stores, to check the temperature setting of your oven. These thermometers may vary 20–40 degrees.

#### **NOTE:**

This adjustment will not affect the broiling or the Self Clean temperatures. The adjustment will be retained in memory after a power failure.

The oven temperature can be increased (+) or decreased (-) as much as 35°F or 19°C.

#### **NOTE:**

Once the temperature is increased or decreased, the display will show the adjusted temperature until it is readjusted.

### *To Adjust the Oven Temperature (For the Lower oven only)*

#### **SETTING**

① Touch **SETTING** pad 2 times for the lower oven, "L-AJ" will appear in the display.

② Using the number pad enter the temperature correction you wish to adjust. Example: to adjust the oven temperature UP 15 degrees, touch 15.

③ Touch **START** pad to accept the change.

④ To lower the oven temperature enter 15 then touch **SETTING** pad to DECREASE the temperature, (for - value).

⑤ Touch **START** pad to accept the change.



### *(For the Upper oven only)*

#### **SETTING**

① Touch **SETTING** pad 3 times for the lower oven, "U-AJ" will appear in the display.

② Using the number pad enter the temperature correction you wish to adjust. Example: to adjust the oven temperature UP 15 degrees, touch 15.

③ Touch **START** pad to accept the change.

④ To lower the oven temperature enter 15 then touch **SETTING** pad to DECREASE the temperature, (for - value).

⑤ Touch **START** pad to accept the change.





## SPECIAL FEATURES OF YOUR OVEN CONTROL (cont')

### How to select language

Your oven control is set to display in English but you may change this to display in Spanish or French.

**SETTING**

- 1 Touch the **SETTING** pad 4 times, "Lng" will appear in the display.
- 2 Touch the # 1 pad for English, touch the # 2 pad for Spanish, touch the # 3 pad for French.
- 3 Touch the **START** pad to accept the change.

### How to set preheating alarm light ON/OFF

The interior oven light automatically turn on when the oven door is opened.

Once the oven is preheated, the oven lamp will flash until the door is opened.

You can activate or deactivate smart oven light feature. Default Setting is On.

**SETTING**

- 1 Touch the **SETTING** pad 5 times "Pre" will appear in the display.
- 2 Touch the # 1 pad for ON or touch the # 2 pad for OFF.
- 3 Touch the **START** pad to accept the change.

### How to adjust beeper volume

The beeper volume feature allows you to adjust the volumes to a more acceptable volume. There are four possible volume levels, loud, normal, low and mute.

**SETTING**

- 1 Touch the **SETTING** pad 6 times and "BEEP" will appear in the display.
- 2 Touch the # 1 pad for LOUD, touch the # 2 pad for NORMAL, touch the # 3 pad for LOW, and touch the # 4 pad for MUTE.
- 3 Touch the **START** pad to accept the change.

### How to select fahrenheit or celsius temperature

Your oven control is set to use the Fahrenheit temperature. This can be changed to Celsius.

**SETTING**

- 1 Touch the **SETTING** pad 7 times and "UNIT" will appear in the display.
- 2 Touch the # 1 pad for F (Fahrenheit) or touch the # 2 pad for C (Celsius).
- 3 Touch the **START** pad to accept the change.

### How to change hour mode on Clock (12HR or 24HR)

Your control is set to use a 12-hour clock. If you would prefer to have a 24-hour time clock, follow the steps below.

**SETTING**

- 1 Touch the **SETTING** pad 8 times. Display will change into **CLO**.
- 2 Touch the number 1 pad for 12-hour, 2 pad for 24-hour.
- 3 Touch the **START** pad to accept the desired change.

# OPERATING INSTRUCTIONS

## USING OVEN RACKS

The racks have a turned-up back edge that prevents the racks from pulling out of the oven cavity.

### To remove racks:

- 1 Pull the rack straight out until it stops.
- 2 Lift up the front of the rack and pull it out.

### To replace racks.

- 1 Place the end of the rack on the support.
- 2 Tilt the front end up and push the rack in.

### NOTE:

In order to remove or replace racks properly, follow the orders recommended in below.

### ⚠ CAUTION

- **DO NOT cover a rack with aluminum foil or any other material or place on the oven bottom.**  
- This will result in poor baking by disturbing heat circulation and may damage the oven bottom.
- **Always arrange oven racks when the oven is cool.**

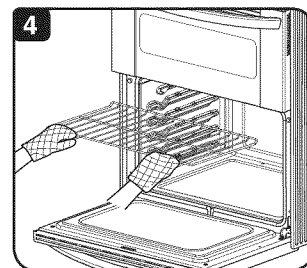
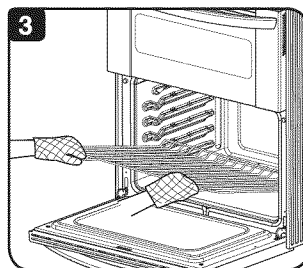
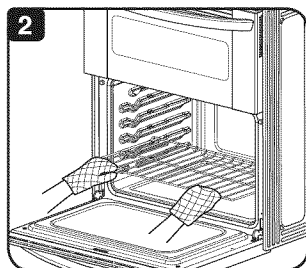
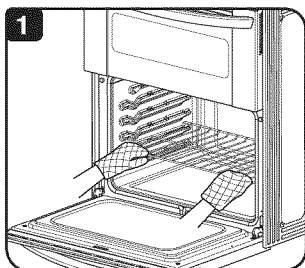

## OVEN VENT

Areas near the vent may become hot during operation and may cause burns. **Do not** block the vent opening. Avoid placing plastics near the vent as heat may distort or melt the plastic.

It is normal for steam to be visible when cooking foods with high moisture.

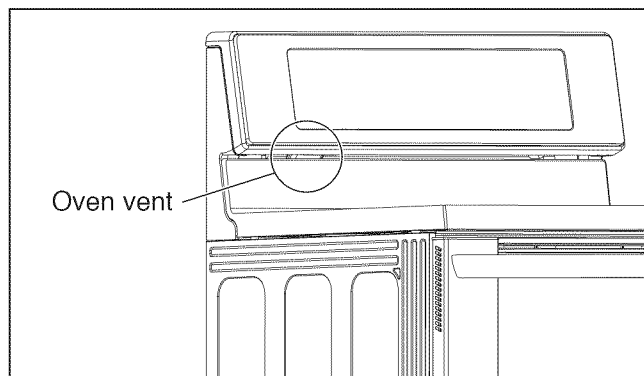

# OPERATING INSTRUCTIONS



## BAKE (For both the Upper & Lower oven)

Baking is done with the lower element only, except during pre-heat the broil element is added to reduce pre-heat times.

Bake is used to prepare foods such as pastries, bread, casseroles, & roasts. The bake guide can be used for both the upper & lower ovens.

The oven can be programmed to bake at any temperature from 170°F (77°C) to 550°F (288°C). Default temperature is 350°F (177°C).



### To set the oven to BAKE and temperature to 375°F

-  **1** Touch **UPPER** or **LOWER BAKE**.
-  **2** Set the oven temperature (Touch **3**, **7** and **5**).
-  **3** Touch **START**.

The word **PREHEATING** and **100°** will be displayed. As the oven preheats the temperature is displayed in 5 degree increments. Once the oven reaches the desired temperature, a tone will sound and the oven light will flash on and off.



### PREHEATING

Place the food in the oven after preheating. Preheating is necessary for better cooking results.

-  **4** When cooking is finished, touch **UPPER** or **LOWER CLEAR OFF**.
- or
- 

- 5** Remove food from the oven.

### To change the Bake Temperature while cooking (example changing from 375°F to 425°F):

-  **1** Touch **UPPER** or **LOWER BAKE**.
-  **2** Set the oven temperature (Touch **4**, **2** and **5**).
-  **3** Touch **START**.

### Tips for baking

Follow the recipe for baking temperature, time and rack position. Baking time and temperature will vary depending on the ingredients, size, and shaped of the baking pan used.

- For best results, food should be baked. food on a single rack with at least 1" to 1 1/2" of air space between the pans and oven walls.
- Check for doneness at the minimum time.
- Use metal bakeware (with or without a nonstick finish), heatproof glass-ceramic, ceramic or other bakeware recommended for oven use.
- Dark metal pans or nonstick coatings will cook faster with more browning. Insulated bake ware will slightly lengthen the cooking time for most foods.

### NOTE:

When doing the bake cook on multiple rack in the lower oven, use the lower oven rack provided for a better cooking result. Please refer to the Figure 1 on next page.

### Displays of the BAKE mode



Upper oven only



Lower oven only

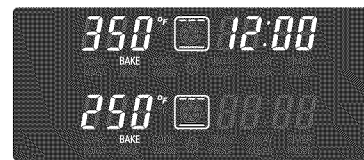

Upper & Lower oven at the same time

# OPERATING INSTRUCTIONS

## BAKING LAYER CAKES

Baking results will be better if baking pans are centered in the oven as much as possible. If baking with more than one pan, place the pans so each has at least 1" to 1½" of air space around it.

If cooking on multiple racks, place the oven racks in positions **B (1 Standard rack)** and **D (1 Offset rack)**. Place the cookware as shown in Fig.1, 2.

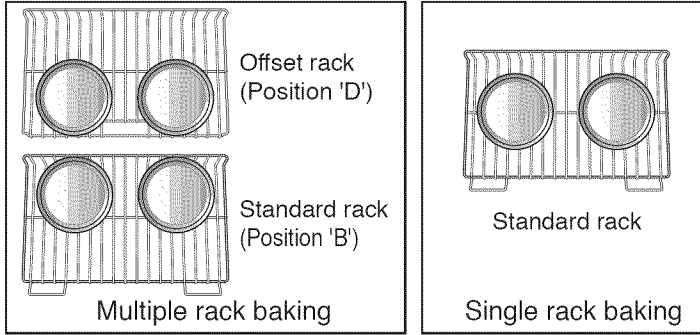
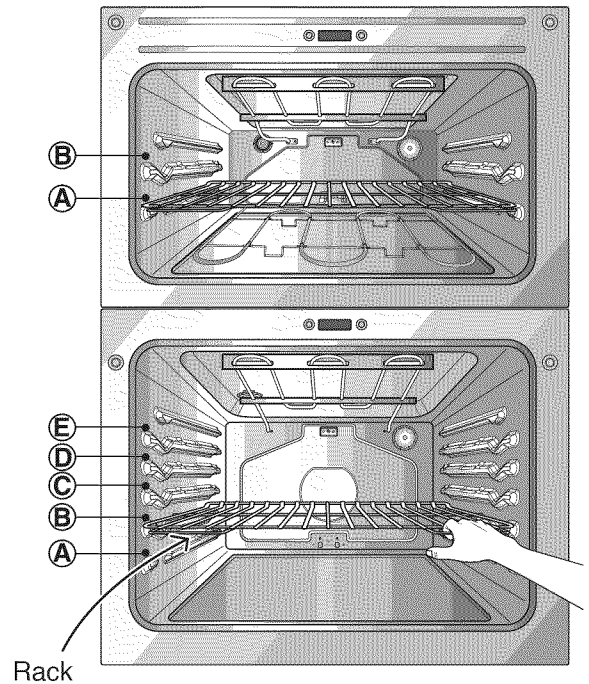

Figure 1

Figure 2



### ⚠ CAUTION

- Be careful not to burn your hands or arms when placing or pulling out pans on the oven racks, specially if cooking on multiple racks. The oven racks could be hot enough to damage your body while cooking.

### Baking Chart

• Do not reduce recipe temperature.

Food	Oven Temperature	Shelf position		Baking time (minutes)
		Upper oven	Lower oven	
<b>Cakes</b>				
- Layer cakes	350°F	A	C	32-35
- Bundt cakes	350°F	A	C	37-43
<b>Cakes, Specialty</b>				
- Cup cakes	350°F	A	C	20-30
- Pound cakes	350°F	A	C	48-52
- Carrot cake, scratch	350°F	A	C	30-45
<b>Cookies</b>				
- Sugar	350°F	A	C	9-16
- Chocolate chips	350°F	A	C	9-16
- Brownies	350°F	A	C	30-35
<b>Pizza</b>				
- Fresh	425°F	A	C	10-15
- Frozen	400°F	A	C	23-27
<b>Breads</b>				
- Biscuit, canned	350°F	A	C	13-17
- Biscuit, scratch	425°F	A	C	10-12
- Muffins	425°F	A	C	9-15
<b>Fruits and Vegetables</b>				
- Apples, baked	375°F	A	B	40-45
- Potatoes, baked	375°F	A	B	60-80

# OPERATING INSTRUCTIONS

## BROIL (For both the Upper & Lower oven)

Broil uses an intense heat radiated from the upper heating element. The Broil function works best when broiling thing tender cuts of meat (1" or less), poultry or fish.

### IMPORTANT NOTE:

- Meat probe cannot be used with this mode

### Before Broiling.

- 1 Place the meat or fish on the broiler grid of the broiler pan.
- 2 Follow suggested shelf positions in the Broiling Guide.

### NOTE:

This range is designed for OPEN DOOR broiling for both the upper and lower ovens.

If broiling with the doors closed it may produce excess smoke or odors.

### Tips for broiling:

- Preheat oven 5 minutes for best broiling results.
- Brush fish and poultry with butter or oil to prevent sticking.
- If you want, use a broiler pan & grid for the best broiling performance. Do not cover the grid with aluminum foil.

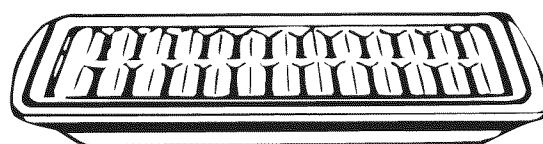

- Use Broil LO to broil foods such as poultry and thick cuts of meat to cook thoroughly with out over cooking them.

### To set the oven to Broil.

**BROIL**

- 1 Touch **UPPER** or **LOWER BROIL** once for **Hi** broil or twice for **Lo** broil.

**START**

LOCKOUT

- 2 Touch **START**. The oven will begin to broil.

- 3 Broil on one side until food is browned; turn and cook on the other side.

### NOTE:

Always pull the rack out to the stop position before turning or removing food.

**UPPER  
CLEAR OFF**

or

**LOWER  
CLEAR OFF**

- 4 When broiling is finished, touch **UPPER** or **LOWER CLEAR OFF**.

Touch CLEAR OFF to cancel Broil at any time.

## CAUTION

- Should an oven fire occur, close the oven door and turn off the oven. If the fire continues, throw baking soda on the fire or use a fire extinguisher.
- **DO NOT put water or flour on the fire.**
  - Flour may be explosive and water can cause a grease fire to spread and cause personal injury.
- **DO NOT use the broiler pan without the grid.**
- **DO NOT cover the grid with aluminum foil.**

### Displays of the BROIL mode



Upper oven only



Lower oven only

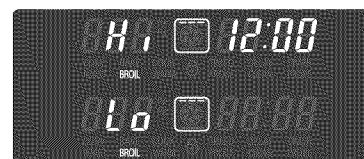

Upper & Lower oven at the same time

# OPERATING INSTRUCTIONS

## RECOMMENDED BROILING GUIDE

The size, weight, thickness, starting temperature, and your preference of doneness will affect broiling times.

This guide is based on meats at refrigerator temperature.

For best results when broiling, use a pan designed for broiling (refer to the Fig.1)

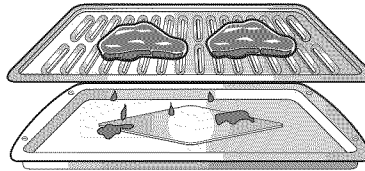
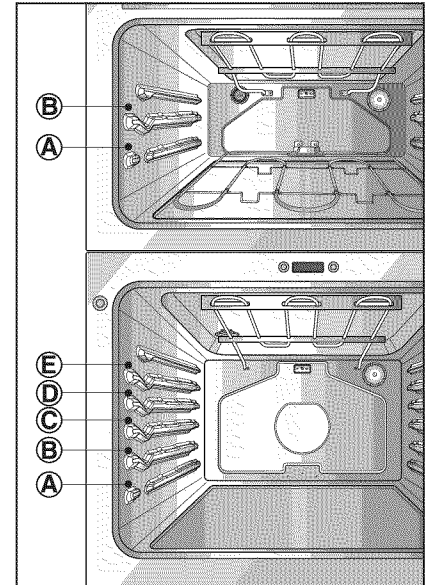

Fig.1

**NOTE:**

When doing the broil cook on the rack position 'E' in the lower oven, choose the offset rack provided for better cooking result.



**Broiling Chart (E : Standard rack, E\*: Offset rack)**

Food	Quantity and/or Thickness	Upper oven			Lower oven			Comments
		Shelf Position	First Side (minutes)	Second Side (minutes)	Shelf Position	First Side (minutes)	Second Side (minutes)	
<b>Ground Beef</b> Well done	1 lb. (4 patties) ½ to ¾" thick	B	6-8	5-7	E*	6-8	5-7	Space evenly. Up to 8 patties may be broiled at once.
<b>Beef Steaks</b>								
Rare	1" thick	B	3-4	2-3	E*	5	2-3	Steaks less than 1" thick cook through before browning. Pan frying is recommended. Slash fat.
Medium	1 to 1½ lbs.	B	4-5	2-3	E*	5-7	3-4	
Well done		B	5-6	3-4	E*	6	4-5	
Rare	1½" thick	A	8	3-4	D	10	4	
Medium	2 to 2½ lbs.	A	9	4-5	D	10-12	5-6	
Well done		A	10	5-6	D	12	6-8	
<b>Chicken</b>								
	1 whole cut up 2 to 2½ lbs., split lengthwise	A	10	4-6	C	14-16	4-6	Broil skin-side-down first.
	2 Breasts	A	9-10	3-5	D	8-9	3-5	
<b>Lobster Tails</b>	2-4 10 to 12 oz. each	-	-	-	B	12-14	Do not turn over	Cut through back of shell. Spread open. Brush with melted butter before broiling and after half of broiling time.
<b>Fish Fillets</b>	¼ to ½" thick	B	5	2-3	D	6	3-4	Handle and turn very carefully. Brush with lemon butter before and during cooking, if desired.
<b>Ham Slices</b> (precooked)	½" thick	B	4-5	2-3	D	6-8	2-4	Increase time 5 to 10 minutes pre side for 1½" thick or home-cured ham.
<b>Pork Chops</b>								
Well done	1 (½" thick) 2 (1" thick) about 1 lb.	B A	7 7	3-5 2-4	E* D	5-6 9-10	2-4 4-6	Slash fat.
<b>Lamb Chops</b>								
Medium	2 (1" thick) about	B	4-5	2-3	D	6	3-4	Slash fat.
Well done	10 to 12 oz.	B	5-6	3-4	D	8	4-5	
Medium	2 (1½" thick)	A	9	4-5	D	10	5-6	
Well done	about 1 lb.	A	10	5-6	D	12	6-8	
<b>Salmon Steaks</b>								
	2 (1" thick)	B	6	3-5	D	8	4-6	Grease pan. Brush steaks with melted butter.
	4 (1" thick) about 1 lb.	A	7	3-5	D	9	4-6	

• This chart is only for reference. Adjust cook time according to your preference.

# OPERATING INSTRUCTIONS

## TIMED COOK (For both the Upper & Lower oven)

This feature is available only for UPPER & LOWER BAKE mode. This guide is applied to UPPER & LOWER BAKE mode equally. The oven will turn on immediately and cook for a selected length of time. At the end of the cooking time, the oven will turn off automatically.

**To set the oven to begin cooking immediately and shut off automatically: (example to set bake at 300°F for 30 minutes.)**

- 1 Be sure the clock is set for the correct time of day.
- 2 Touch **UPPER** or **LOWER BAKE**, 350°F will appear in the display.
- 3 Set the oven temperature (Touch **3**, **0** and **0**).
- 4 Touch **COOK TIME**. **TIMED** will flash. **BAKE**, **0:00** and **300°F** will appear in the display.
- 5 Set the desired baking time (Touch **3** and **0**).

**NOTE:**

Baking time can be set for any amount of time between 1 minute to 11 hours and 59 minutes.

- 6 Touch **START**. The oven will turn on, and the display will show the cooking time countdown. The oven will continue to cook for the set amount of time, then turn off automatically, unless the **WARM** feature was set. Refer to the Setting the **WARM** feature section on page 30.

- 7 Touch **CLEAR OFF** to cancel this function at any time.



or



**To change the cook time while operating the oven. (example to change the cook time from 30 minutes to 1 hour 30 minutes.)**



- 1 Touch **COOK TIME**.



- 2 Set the changed baking time (Touch **1**, **3** and **0**).



- 3 Touch **START** to accept the change or touch **CLEAR OFF** to reset the time you input.

**When Timed Cook finishes:**

- 1 **END OF CYCLE** and the time of day will show in the display. The oven will shut off automatically.

- 2 The **COOK END** indicator tone will sound every 60 seconds until the **CLEAR OFF** is touched.



or



**NOTE:**

- If operating both the upper & lower ovens touch cook time pad once to set the cook time for the lower oven and twice for the upper oven.

# OPERATING INSTRUCTIONS

## DELAYED TIMED COOK (For both the Upper & Lower oven)

This feature is available only for UPPER & LOWER BAKE mode.

This guide is applied to UPPER & LOWER BAKE mode equally.

The automatic timer of the Delayed Timed Cook will turn the oven ON and OFF at the time you select in advance.

**To set the oven for a Delayed Start .  
(example to set BAKE at 300°F for 30 minutes  
and start operating the bake mode at 4:30pm)**

- 1 Be sure that the clock is set with the correct time of day.
- 2 Arrange interior oven rack(s) and place the food in the oven.
- 3 Touch **BAKE**. 350°F will appear in the display.

**BAKE**

**3 0 0**

- 4 Set the oven temperature (Touch **3**, **0** and **0**).

**COOK TIME**

**3 0**

- 5 Touch **COOK TIME**.
- 6 Set the desired baking time (Touch **3** and **0**).  
**NOTE:**  
Baking time can be set for any amount of time from 1 minute to 11 hours and 59 minutes.

**START TIME**

**4 3 0**

- 7 Touch **START TIME**.
- 8 Set the desired start time (Touch **4**, **3** and **0**).  
**NOTE:**  
If you want to change cook time, repeat steps 5~8 and touch **START**.

**START**

LOCKOUT

- 9 Touch **START**. At the set time, a short beep will sound. The oven will begin to Bake.

**UPPER CLEAR OFF**

or

**LOWER CLEAR OFF**

- 10 Touch **CLEAR OFF** to cancel Delayed Timed Bake at any time.

**When the Delayed Timed Cook finishes:**

- 1 **END OF CYCLE** and the time of day will show in the display. The oven will shut off automatically.
- 2 The **COOK END** indicator tone will sound every 60 seconds until the **CLEAR OFF** is touched.

**UPPER CLEAR OFF**

or

**LOWER CLEAR OFF**

### NOTE:

- If you set 12-hours clock, the maximum hours you can delay will be just 12-hours. If you set 24 hours clock, you can delay the cook for 24 hours.

### CAUTION

- Use caution with the **TIMED BAKE** or **DELAYED TIMED BAKE** features. Use the automatic timer when cooking cured or frozen meats and most fruits and vegetables. Foods that can easily spoil, such as milk, eggs, fish, meat or poultry, should be chilled in the refrigerator first. Even when chilled, they should not stand in the oven for more than 1 hour before cooking begins, and should be removed promptly when cooking is completed.
- Eating spoiled food can result in sickness from food poisoning.



# OPERATING INSTRUCTIONS

## PIZZA (For the Upper oven only)

Pizza is used when cooking pizza especially. Pizza adds the oven from top to bottom to give more evenly browned foods.

This is designed to give the most optimum cooking performance for the pizza selected by automatic combination of broil and bake heating system.

When using this function, there is no need to preheat the oven prior to cooking.

By using smaller space than lower oven, it also provides heating efficiency.

**NOTE:**

This function is offered only for the **UPPER OVEN**. You can use PIZZA function through the UPPER OVEN.

**To use the oven for PIZZA (UPPER OVEN ONLY)**



① Touch **PIZZA** once. **P1, P2** will appear in the display. Whenever you touch **PIZZA** one more time, the display will appear **P1, P2, P1, P2, ...** in order.



② Touch **START**. PIZZA function will be started operating.



③ Touch **UPPER CLEAR OFF** to cancel PIZZA at any time.

**Displays of the PIZZA mode**



Upper oven only



Upper & Lower oven at the same time

**Pizza Chart**

Display Mode	Food	Recommended quantity	Shelf position	Recommended time (minutes)
P1	Frozen pizza, Regular crust	12"	A	13-18
P2	Frozen pizza, Rising crust	12"	A	18-20

• This chart is only for reference. Adjust cook time according to your preference.

# OPERATING INSTRUCTIONS





## WARM (For both the Upper & Lower oven)

The WARM function will maintain an oven temperature of 170°F. This function should not be used to reheat cold food. The Warm function will keep cooked food warm for serving up to 3 hours after cooking has finished. After 3 hours the WARM function will shut the oven OFF automatically. The Warm function may be used without any other cooking operations or can be used after cooking has finished using TIMED BAKE or DELAYED TIMED BAKE.





### NOTE:

When the lower oven operates at above 475°F, the warm function of the upper oven can't be used. Oven is hot to warm will appear on the display.

### To set Warm:

- 1 Touch the **WARM** once.
  - 2 Touch **START**.
  - 3 To turn Warm off, touch **UPPER** or **LOWER OFF** at any time.
- 
- 
- 
- or
- 

### To set Warm feature after timed cooking

- 1 Set the cooking feature that you want to use: **TIMED BAKE**, **DELAYED TIMED BAKE** refer to the relevant previous page.
  - 2 Touch **START**.
  - 3 Touch the **WARM** once. COOK & WARM mode is set to turn on automatically after completing the TIMED COOKING or DELAYED TIMED COOKING.
  - 4 To turn Cook & Warm off at any time touch **CLEAR OFF**.
- 
- 
- 
- or
- 

### Displays of the WARM mode



Upper oven only

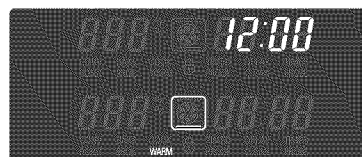

Lower oven only

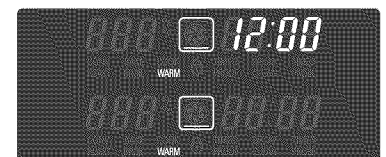

Upper & Lower oven at the same time

# OPERATING INSTRUCTIONS

## PROOF (For the Lower oven only)

The Proof feature maintains a warm environment for rising yeast leavened products before baking. To avoid lowering the oven temperature and lengthening proofing time, do not open the oven door unnecessarily. Check bread products early to avoid over-proofing.

### Before Proof.

Place the covered dough in a dish in the oven on rack B or C.



### NOTE:

For best results, cover the dough with a cloth or with plastic wrap (the plastic may need to be anchored underneath the container so the oven fan does not blow it off).

### NOTE:

- Do not use the proofing mode for warming food or keeping food hot. The proofing oven temperature is not hot enough to hold foods at safe temperatures. Use the WARM feature to keep food warm.
- Proofing will not operate when oven is above 150°F. Oven is Hot will show in the display.

### To set Proof:

-  Touch **PROOF** once.
-  Touch **START** The proof feature automatically provides the optimum temperature for the proof process, and therefore does not have a temperature adjustment.
-  When proofing is finished, touch **CLEAR OFF**.

### Displays of the PROOF mode

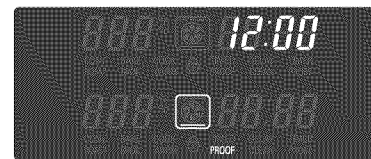

Lower oven only

# OPERATING INSTRUCTIONS

## SABBATH MODE (For both the Upper & Lower Oven)

Sabbath mode is used on the Jewish Sabbath and Holidays. After the Sabbath mode is activated all function keys except UPPER and LOWER CLEAR OFF are inactive. Sb will appear in both the cooktop and oven displays.

**NOTE:** If the cooktop had been used prior to setting the Sabbath mode HS will appear in the cooktop displays.

Once the oven light is turned ON and the Sabbath mode is active, the oven light will remain ON until the Sabbath mode is turned OFF.

If the oven light needs to be OFF, be sure to turn the oven light OFF before activating the Sabbath mode.

**NOTE:**

Sabbath mode can only be used in the following conditions.

During Sabbath mode only the BAKE function can be used.

- Case 1: Upper oven-Bake mode      Lower oven-off
- Case 2: Upper oven-Bake mode      Lower oven-Bake mode
- Case 3: Upper oven-off              Lower oven-Bake mode

### To use the oven for SABBATH MODE

- 1 Before using the Sabbath mode check that the oven you are going to use is in one of the functions (conditions) mentioned above. The Sabbath mode can only be used in the Bake mode. If timed bake is desired, activate now. One oven can be in timed bake while the other can be set to run continuous. Refer to page 27.

**SETTING**



or



**SETTING**

- 2 To enter Sabbath mode, Touch and hold **SETTING** for 3 seconds.
- 3 Touch **UPPER & LOWER CLEAR OFF** to quit Bake mode at any time.
- 4 To cancel Sabbath mode, Touch and hold **SETTING** for 3 seconds to cancel Sabbath mode.

**NOTE:**

#### Sabbath mode temperature adjustment

- During the Sabbath mode temperature adjustments to the ovens can be made.
- Ovens can not be turned on after the Sabbath mode has been activated.

### To change the Bake Temperature while using the sabbath mode. (No beep sound & No display change)

**BAKE**

- 1 Touch **UPPER** or **LOWER BAKE**.



- 2 Set the oven temperature you want. (Touch number pads.)

- 3 Touch **START**.

**NOTE:**

After changing the temperature while the unit is in Sabbath mode there is a 15 second delay before the unit will recognize the change.

### Displays of the SABBATH MODE



Upper oven only

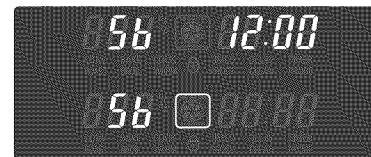

Lower oven only



Upper & Lower oven at the same time

**NOTE:**

icon is the oven "ON" indicator in Sabbath mode.

## TO TURN ON or OFF THE OVEN LIGHT (For both the Upper & Lower oven)

**UPPER  
LIGHT**

or

**LOWER  
LIGHT**

The oven light automatically turns ON when the door is opened. The oven light may also be manually turned ON or OFF by touching the **OVEN LIGHT feature**.

**NOTE:**

The oven light cannot be turned on if the self clean feature is active.

## OVEN & COOKTOP LOCKOUT FEATURE (For both the Upper, Lower oven & Cooktop)

The START pad controls the Oven and Cooktop Lockout Feature. The Oven and Cooktop Lockout features locks out both Oven doors and prevents the cooktop elements from being turned on. It does not disable the clock, timer or oven lights.

### *Activate the lock out feature:*



- 1 Touch and hold **START** pad for 3 seconds.
- 2 Lock melody will sound, **LOCKING** will appear in the display. Once the oven door is locked the "**OVEN LOCKOUT**" will be displayed along with the lock icon(  ) light.

### *Deactivate normal oven operation:*



- 1 Touch and hold **START** pad for 3 seconds. Unlock melody will sound 2 times. The "**UNLOCKING**" will be displayed until the oven door has completely unlocked and the lock icon(  ) light will clear.
- 2 The Ovens & Cooktop are fully operational again.

**NOTE:**

- When the Oven and Cooktop lockout mode is activated only the clock, kitchens timers and oven lights will operate.

# OPERATING INSTRUCTIONS

## SELF CLEAN (For both the Upper & Lower oven)

The self clean cycle uses above normal cooking temperatures to clean the oven cavity. You may see some smoke and smell an odor the first few times the oven is cleaned. This is normal and will lessen in time. Smoke may also occur if the oven is heavily soiled. During self clean, the kitchen should be well ventilated to minimize the odors from cleaning. The UPPER & LOWER SELF CLEAN cannot be operated simultaneously.

### **⚠ CAUTION**

• **DO NOT leave small children unattended near the appliance.**

- During the self cleaning cycle, the outside of the range can become very hot to touch.

• **Move Birds to another well-ventilated room.**

- The health of some birds is extremely sensitive to the fumes given off during the Self Cleaning cycle of any range.

• **DO NOT line the oven walls, racks, bottom or any other part of the range with aluminum foil or any other material.**

- Doing so will destroy heat distribution, produce poor baking results and cause permanent damage to the oven interior (aluminum foil will melt to the interior surface of the oven).

• **DO NOT force the door open.**

- This can damage the automatic door locking system. Use care when opening the oven door after the Self Cleaning cycle. Stand to the side of the oven when opening the door to allow hot air or steam to escape. The oven may still be VERY HOT.

### **Before a Self Clean Cycle**

We recommend venting your kitchen with an open window or using a ventilation fan or hood during the first self clean cycle.

Remove the oven racks, broiler pan, broiler grid, all cookware, and aluminum foil or any other material from the oven.

#### **NOTE:**

It is normal for smoke to occur during self clean. Make sure the room is well ventilated before running a self clean cycle.

### **⚠ CAUTION**

• The oven broil element may appear to have cooled after it has been turned OFF. The element may still be hot and burn may occur if this element is touched before it has cooled sufficiently.

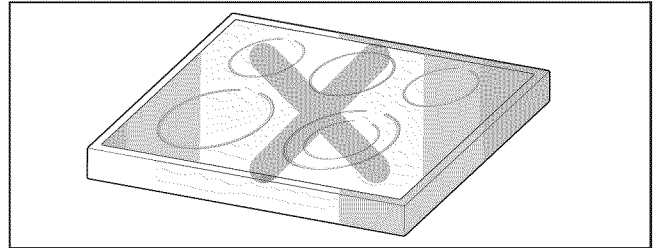

During a self clean cycle in either the upper or lower oven the cooktop elements can not be used. If running a self clean in one of the ovens the other oven can not be used. Self clean can only be run in one oven at a time.

#### **NOTE:**

Remove oven racks and accessories before starting the self clean cycle.

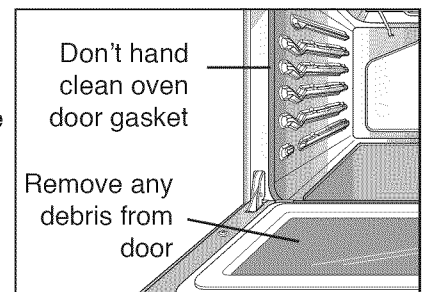

- If oven racks are left in the oven cavity during the self clean cycle, they will discolor and become difficult to slide in and out.
- Clean the frame of the oven and door with hot soapy water. Rinse well.
- Do not clean the gasket. The fiberglass material of the oven door gasket cannot withstand abrasion. It is essential for the gasket to remain intact. If you notice it becoming worn or frayed, replace it.
- Wipe up any heavy spillovers on the oven bottom.
- Make sure the oven light bulb cover is in place and the oven light is off.

# OPERATING INSTRUCTIONS

## SELF CLEAN (For both the Upper & Lower oven) (cont')

The **UPPER & LOWER SELF CLEAN** pad is used to start a Self Clean cycle. When used with **START TIME** pad, a delayed Self Clean cycle may also be programmed. The Self-Clean function has cycle times of 3, 4, or 5 hours.

### To start an immediate **UPPER** or **LOWER SELF CLEAN** cycle and shut off automatically

#### NOTE:

Before running a self-clean cycle be sure to remove all racks and accessories.

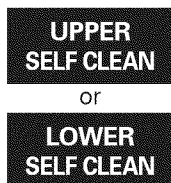
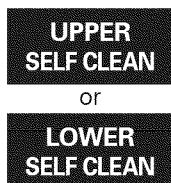

- 1 Be sure the clock is set with the correct time of day, the ovens are empty and both oven doors are closed.
- 2 Touch **UPPER** or **LOWER SELF CLEAN** once for a 3-hour clean time, twice for a 4-hour clean time, or 3 times for 5-hour clean time. A 3-hour selfclean time is recommended for use when cleaning small, contained spills. A self clean time of 5 hours is recommended for heavily soiled ovens.
- 3 Touch **START**. The **DOOR LOCKED** icon will flash.
- 4 Once the **UPPER** or **LOWER SELF CLEAN** is set, the oven door will lock automatically. You will not be able to open the oven door until the oven is cooled. The lock will release automatically.

### During the Self Clean cycle

- You may see some smoke and smell an odor the first few times the oven is cleaned. This is normal and will lessen in time. Smoke may also occur if the oven is heavily soiled or if a broiler pan was left in the oven.
- As the oven heats, you may hear sounds of metal parts expanding and contracting. This is normal and will not damage the oven.
- Do not force the oven door open when **LOCKED** is displayed. The oven door will remain locked until the oven temperature has cooled. Forcing the door open will damage the door.

### To set a delay start time

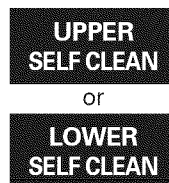

- 1 Touch **UPPER** or **LOWER SELF CLEAN**. Select the desired self clean time by touching **UPPER** or **LOWER SELF CLEAN**.
- 2 Touch **START TIME**. **DELAY** is flashing
- 3 Set the desired start time.
- 4 Touch **START**. **DELAY** and **CLEAN** will remain on.
- 5 Self Cleaning cycle will turn on automatically at the set time.

### Displays of the SELF CLEAN mode



Upper oven only

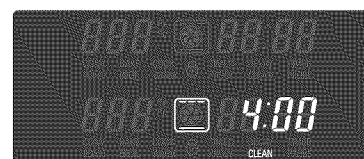

Lower oven only

# OPERATING INSTRUCTIONS

## SELF CLEAN (For both the Upper & Lower oven) (cont')

If it becomes necessary to stop or interrupt a selfcleaning cycle due to excessive smoke or fire in the oven:



or



- 1 Touch **UPPER & LOWER CLEAR OFF**.

- 2 After the oven has cooled down, the **DOOR LOCK** will automatically release allowing you to open the oven door.

### **NOTE:**

When using the Self Clean feature:

Self Clean can only be run in one oven at a time.

- A Self Clean cycle cannot be started if Oven Lockout feature is active.
- Once the SELF CLEAN is set, the oven door will lock automatically. You will not be able to open the oven door until the oven is cooled. The lock will release automatically.
- Once the door has been locked the LOCKED indicator light will stop flashing and remain on. Allow about 15 seconds for the oven door lock to close.
- If your clock is set for normal 12 hours display mode the Delayed Self Clean can never be set to start more than 12 hours in advance. To set for a delayed Self Clean cycle 12- 24 hours in advance, see page 18 for instructions to set the control for the 24 hours time of day display mode.

### **When the self clean cycle is done**

- It will not be possible to open the oven door until oven temperature has cooled.
- It is recommend to use 3 hours cycle for average soil, and 5 hours cycle for heavy soil.
- Additional time is needed to cool the oven down. Therefore, the oven door will not release from the lock position until after it has cooled.

### **After the Self Clean cycle**

- You may notice some white ash in the oven. Wipe it off with a damp cloth or a soap-filled steel wool pad after the oven cools. If the oven is not clean after one clean cycle, repeat the cycle.
- If oven racks were left in the oven and do not slide smoothly after a clean cycle, wipe racks and rack supports with a small amount of vegetable oil to make them glide easier.
- Fine lines may appear in the porcelain because it went through heating and cooling. This is normal and will not affect performance.



## CARE & CLEANING

### Changing the Oven Light

The oven light is a standard 40-watt appliance bulb. It will come on when the oven door is open. When the oven door is closed, press UPPER or LOWER OVEN LIGHT to turn it on or off.

#### To replace:

- Make sure oven and bulb are cool.
- 1. Unplug range or disconnect power.
- 2. Turn the glass bulb cover in the back of the oven counterclockwise to remove.
- 3. Turn bulb counterclockwise to remove from socket.
- 4. Replace bulb and bulb cover by turning clockwise.
- 5. Plug in range or reconnect power.

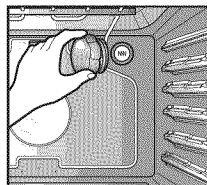

### **WARNING**

- **Before replacing your oven light bulb, DISCONNECT the electrical power to the range at the main fuse or circuit breaker panel.**
  - Failure to do so can result in severe personal injury, death, or electrical shock.
- **Make sure oven and bulb are cool.**

### Painted and Decorative Trim

For general cleaning, use a cloth with hot soapy water. For more difficult soils and built-up grease, apply a liquid detergent directly onto the soil. Leave on soil for 30 to 60 minutes. Rinse with a damp cloth and dry.

**DO NOT** use abrasive cleaners on any of these materials; they can scratch.

### Stainless Steel Surfaces (on some models)

**Do not use a steel-wool pad; it will scratch the surface.**

1. Using a Stainless Steel Appliance cleaner or polish, place a small amount on a damp cloth or paper towel.
2. Clean a small area, rubbing with the grain of the stainless steel if applicable.
3. Dry and buff with a clean, dry paper towel or soft cloth.
4. Repeat as necessary.

### Broiler Pan and Grid

**(NOT included in this model)**

**Do not clean the broiler pan or grid in a selfcleaning mode.**

After broiling, remove the broiler pan from the oven. Remove the grid from the pan. Carefully pour out the grease from the pan into a proper container.

**Wash and rinse the broiler pan and grid in hot water with a soap-filled or plastic scouring pad.**

If food has burned on, sprinkle the grid with cleaner while hot and cover with wet paper towels or a dishcloth. Soaking the pan will remove burned-on foods.

**Both the broiler pan and grid may be cleaned with a commercial oven cleaner.**

Both the broiler pan and grid can also be cleaned in a dishwasher.



Do not store a soiled broiler pan and grid anywhere in the range.

# MAINTENANCE

## CARE & CLEANING (cont')

### Oven Racks

Remove the oven racks before operating the selfclean cycle.

Leaving the racks in place could cause discoloration, and, if food is spilled into the tracks, could cause the racks to become stuck. If left, clean by using a mild, abrasive cleaner. Rinse with clean water and dry.

If the racks are cleaned in the self clean cycle, their color will turn slightly blue and the finish will be dull. After the self clean cycle is complete, and the oven has cooled, rub the sides of the racks with wax paper or a cloth containing a small amount of oil. This will make the racks glide easier into the rack tracks.

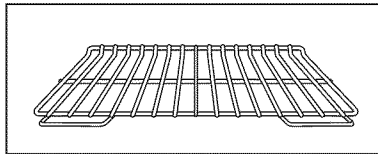

### Oven door

Use soap and water to thoroughly clean the top, sides, and front of the oven door. Rinse well. You may use a glass cleaner on the outside glass of the oven door. **DO NOT** immerse the door in water. **DO NOT** spray or allow water or the glass cleaner to enter the door vents. **DO NOT** use oven cleaners, cleaning powders, or any harsh abrasive cleaning materials on the outside of the oven door.

**DO NOT** clean the oven door gasket. The oven door gasket is made of a woven material which is essential for a good seal. Care should be taken not to rub, damage, or remove this gasket.

### CAUTION

- **DO NOT** use harsh abrasive cleaners or sharp metal scrapers to clean the oven door glass since they can scratch the surface.
- It may result in shattering of the glass.

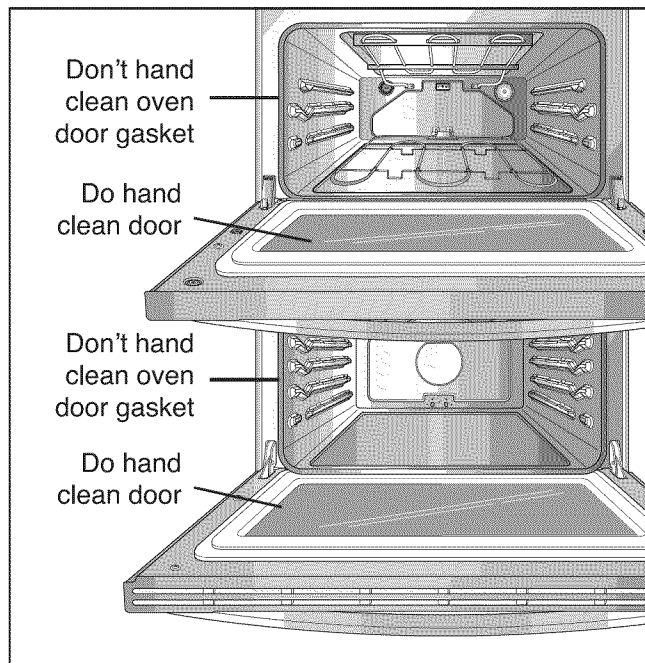

## CLEANING THE GLASS/CERAMIC COOKTOP

### Normal Daily Use Cleaning

Use Ceramic Cooktop Cleaner on the glass cooktop. Other creams may not be as effective or may scratch, damage or stain the cooktop surface.

To maintain and protect the surface of your glass cooktop, follow these steps:

1. Before using the cooktop for the first time, clean with a ceramic cooktop cleaner. This helps protect the top and makes cleanup easier.
2. Daily use of ceramic cooktop cleaner will help keep the cooktop looking new.
3. Shake the cleaning cream well. Apply a few drops of cleaner directly to the cooktop.
4. Use a paper towel to clean the entire cooktop surface.
5. Rinse with clear water and use a dry cloth or paper towel to remove all cleaning residue.

### NOTE:

**DO NOT** heat the cooktop until it has been cleaned thoroughly.

### CAUTION

- **DO NOT** use scrub pads or abrasive cleaning pads.
- They may damage your glass cooktop surface.
- **For your safety please wear an oven mitt/pot holder while cleaning the hot cooking surface.**

## CLEANING THE GLASS/CERAMIC COOKTOP (cont')

### Burned-On Residue

#### To clean the glass/ceramic cooktop

##### Step. 1

First remove any burnt-on deposits or spilled food from your glass/ceramic cooking surface with a suitable metal razor scraper (similar to scraping paint off of your windowpanes in your home - it will not damage the decorated cooking surface). Hold the scraper at approximately a 30° angle to the cooktop.

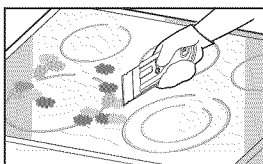

##### NOTE:

Do not use a dull or nicked blade. For your safety, please wear an oven mitt/pot holder while using the metal scraper.

##### Step. 2

When the cooking surface has cooled down apply a few dabs (about the size of a dime) of an approved cleaner in each burner area and work the cleaning cream over the cooktop surface with a damp paper towel as if you were cleaning a window.

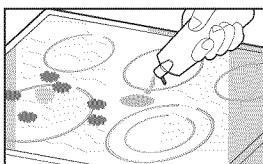

**NOTE:** Approved cleaners

**Weiman CookTop Cleaning Cream** ([www.weiman.com](http://www.weiman.com))

**Cerama Bryte** ([www.ceramabryte.com](http://www.ceramabryte.com))

**Golden Ventures Cerama Bryte**

**Easy-Off 3 in 1 Glass Top Cleaner Spray** ([www.easyoff.us](http://www.easyoff.us)).

##### Step. 3

As a final step, clean with clear water and wipe the cooktop surface with a clean, dry paper towel.

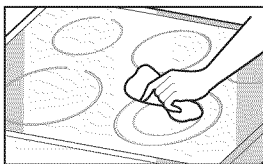

### CAUTION

- Clean Cook-Top With Caution – If a wet sponge or cloth is used to wipe spills on a hot cooking area, be careful to avoid steam burn. Some cleaners can produce noxious fumes if applied to a hot surface.

### IMPORTANT:

If any sugar or food containing sugar (preserves, ketchup, tomato sauce, jellies, fudge, candy, syrups, chocolate, etc.), a plastic item or kitchen foil accidentally melts on the hot surface of your cooktop, remove the molten material IMMEDIATELY with a metal razor scraper (it will not damage the decorated cooking surface) while the cooking surface is still hot to avoid the risk of damage to the glass-ceramic surface. For your safety please wear an oven mitt/pot holder while cleaning the hot cooking surface.

### Metal Marks and Scratches

1. Be careful not to slide pots and pans across your cooktop. It will leave metal markings on the cooktop surface. These marks are removable using the Ceramic Cooktop Cleaner with the Cleaning Pad for Ceramic Cooktops.
2. If pots with a thin overlay of aluminum or copper are allowed to boil dry, the overlay may leave black discoloration on the cooktop. This should be removed immediately before heating again or the discoloration may be permanent.

### CAUTION

- Cookware with rough or uneven bottoms can mark or scratch the cooktop surface.
- Do not slide metal or glass across the cooktop surface.
- Do not use cookware with any dirt build up on bottom.

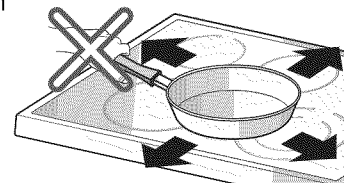

### Cooktop Seal

To clean the cooktop seal around the edges of the glass, lay a wet cloth on it for a few minutes, then wipe clean with nonabrasive cleaners.

## REMOVING & REPLACING THE LIFT-OFF OVEN DOOR

### CAUTION

- Be careful when removing and lifting the door.
- DO NOT lift the door by the handle.
  - The door is very heavy.

### UPPER OVEN

#### To remove the door:

##### Step. 1

Fully open the door.

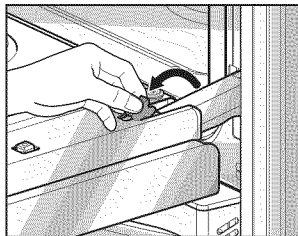

##### Step. 2

Lift up on the hinge lock toward the oven frame until they stop.

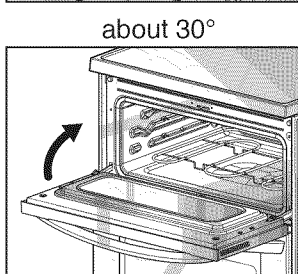

about 30°

##### Step. 3

Close the door to 30 degrees (you will feel the door stop). The hinge lock will contact the oven frame.

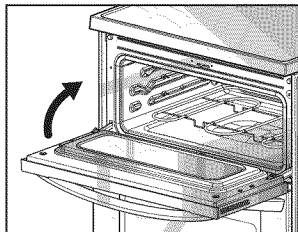

##### Step. 4

On both sides of the door, press down on the release buttons on each hinge.

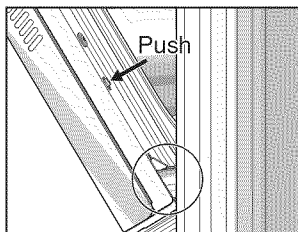

Push

##### Step. 5

Lift door up until it is clear of the hinge.

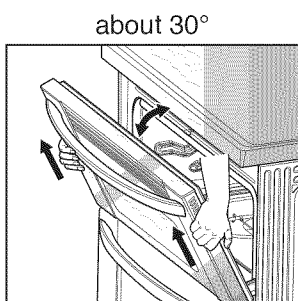

about 30°

#### To replace the door:

##### Step. 1

Be sure both hinges are in a 30 degree position.

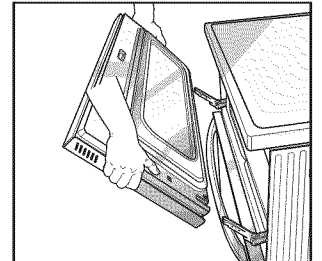

##### Step. 2

Slide the door back onto the hinges until you hear a solid click and the release buttons have engaged.

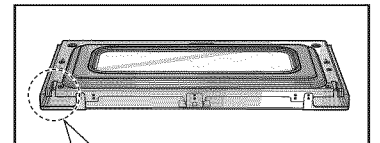

##### Step. 3

Fully open the door.

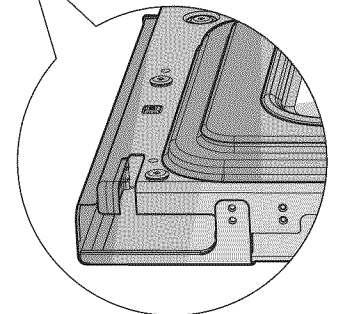

##### Step. 4

Push the hinge locks down onto the hinge.

##### Step. 5

Close the oven door.

about 30°

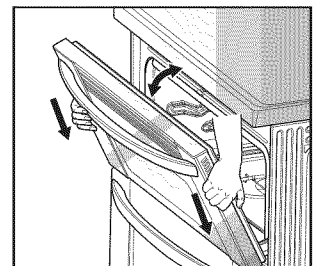

## REMOVING & REPLACING THE LIFT-OFF OVEN DOOR (cont')

### LOWER OVEN

#### To remove the door:

##### Step. 1

Fully open the door.

##### Step. 2

Pull the hinge locks up toward the door frame to the unlocked position.

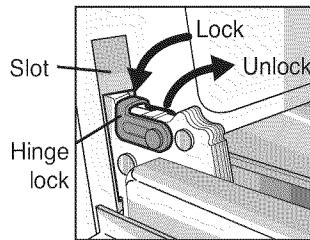

##### Step. 3

Firmly grasp both sides of the door at the top.

##### Step. 4

Close door to the door removal position, which is approximately 5 degrees.

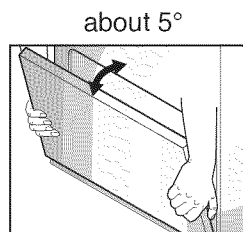

##### Step. 5

Lift door up and out until the hinge arm is clear of the slot.

#### To replace the door:

##### Step. 1

Firmly grasp both sides of the door at the top.

##### Step. 2

With the door at the same angle as the removal position, seat the indentation of the hinge arm into the bottom edge of the hinge slot. The notch in the hinge arm must be fully seated into the bottom edge of the slot.

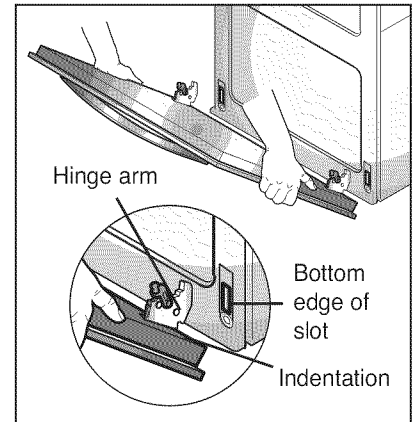

##### Step. 3

Open the door fully. If the door will not open fully, the indentation is not seated correctly in the bottom edge of the slot.

##### Step. 4

Push the hinge locks down against the front frame of the oven cavity to the locked position.

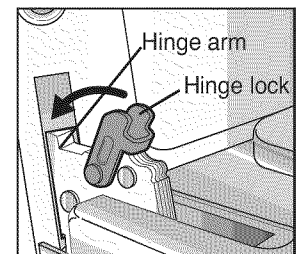

##### Step. 5

Close the oven door.

## DOOR CARE INSTRUCTIONS

- Most oven doors contain glass that can break.

#### Read the following recommendations:

1. Do not close the oven door until all the oven racks are fully in place.

2. Do not hit the glass with pots, pans, or any other object.
3. Scratching, hitting, jarring, or stressing the glass may weaken its structure causing an increased risk of breakage at a later time.

# TROUBLESHOOTING

## BEFORE CALLING FOR SERVICE

Before you call for service, review this list. It may save you time and expense. The list includes common occurrences that are not the result of defective workmanship or materials in this appliance.

Problem	Possible Causes / Solutions								
<p><b>Range is not level.</b></p>	<ul style="list-style-type: none"> <li>• Poor installation. Place oven rack in center of oven. Place a level on the oven rack. Adjust leveling legs at base of range until the oven rack is level.</li> <li>• Be sure floor is level and strong and stable enough to adequately support range.</li> <li>• If floor is sagging or sloping, contact a carpenter to correct the situation.</li> <li>• Kitchen cabinet alignment may make range appear unlevel. Be sure cabinets are square and have sufficient room for range clearance.</li> </ul>								
<p><b>Cannot move appliance easily. Appliance must be accessible for service.</b></p>	<ul style="list-style-type: none"> <li>• Cabinets not square or are built in too tightly. Contact builder or installer to make appliance accessible.</li> <li>• Carpet interferes with range. Provide sufficient space so range can be lifted over carpet.</li> <li>• Anti-tip device engaged</li> </ul>								
<p><b>Oven control beeps and displays any F code error.</b></p>	<ul style="list-style-type: none"> <li>• Electronic control has detected a fault condition. Touch <b>CLEAR OFF</b> to clear the display and stop beeping. Reprogram oven. If fault recurs, record fault number. Touch <b>CLEAR OFF</b> and contact a Service agent.</li> </ul> <table border="1" data-bbox="1138 910 1533 1087"> <thead> <tr> <th data-bbox="1138 910 1252 942">CODE</th> <th data-bbox="1252 910 1533 942">CAUSE</th> </tr> </thead> <tbody> <tr> <td data-bbox="1138 942 1252 981">F-3</td> <td data-bbox="1252 942 1533 981">Shorted keypad</td> </tr> <tr> <td data-bbox="1138 981 1252 1044">F-10</td> <td data-bbox="1252 981 1533 1044">Door locking system doesn't operate</td> </tr> <tr> <td data-bbox="1138 1044 1252 1087">F-11</td> <td data-bbox="1252 1044 1533 1087">No heating</td> </tr> </tbody> </table>	CODE	CAUSE	F-3	Shorted keypad	F-10	Door locking system doesn't operate	F-11	No heating
CODE	CAUSE								
F-3	Shorted keypad								
F-10	Door locking system doesn't operate								
F-11	No heating								
<p><b>Surface units will not maintain a rolling boil or cooking is not fast enough.</b></p>	<ul style="list-style-type: none"> <li>• Improper cookware being used.               <ul style="list-style-type: none"> <li>- Use pans which are flat and match the diameter of the surface unit selected.</li> </ul> </li> <li>• In some areas, the power (voltage) may be low.               <ul style="list-style-type: none"> <li>- Cover pan with a lid until desired heat is obtained.</li> </ul> </li> </ul>								
<p><b>Surface units do not work properly.</b></p>	<ul style="list-style-type: none"> <li>• A fuse in your home may be blown or the circuit breaker tripped.               <ul style="list-style-type: none"> <li>- Replace the fuse or reset the circuit breaker.</li> </ul> </li> <li>• Cooktop controls improperly set.               <ul style="list-style-type: none"> <li>- Check to see the correct control is set for the surface unit you are using.</li> </ul> </li> </ul>								
<p><b>Surface unit stops glowing when changed to a lower setting.</b></p>	<ul style="list-style-type: none"> <li>• This is normal. The unit is still on and hot.</li> </ul>								
<p><b>Areas of discoloration on the cooktop.</b></p>	<ul style="list-style-type: none"> <li>• Food spillovers not cleaned before next use.               <ul style="list-style-type: none"> <li>- See <b>Cleaning the glass cooktop</b> section.</li> </ul> </li> <li>• Hot surface on a model with a light-colored cooktop.               <ul style="list-style-type: none"> <li>- This is normal. The surface may appear discolored when it is hot. This is temporary and will disappear as the glass cools.</li> </ul> </li> </ul>								
<p><b>Frequent cycling on and off of surface units.</b></p>	<ul style="list-style-type: none"> <li>• This is normal.               <ul style="list-style-type: none"> <li>- The element will cycle on and off to maintain the heat setting.</li> </ul> </li> </ul>								

## BEFORE CALLING FOR SERVICE (cont')

Problem	Possible Causes / Solutions
<p><b>Oven will not work.</b></p>	<ul style="list-style-type: none"> <li>• Plug on range is not completely inserted in the electrical outlet.                             <ul style="list-style-type: none"> <li>- Make sure electrical plug is plugged into a live, properly grounded outlet.</li> </ul> </li> <li>• A fuse in your home may be blown or the circuit breaker tripped.                             <ul style="list-style-type: none"> <li>- Replace the fuse or reset the circuit breaker.</li> </ul> </li> <li>• Oven controls improperly set.                             <ul style="list-style-type: none"> <li>- See the Using the oven section.</li> </ul> </li> <li>• Oven too hot.                             <ul style="list-style-type: none"> <li>- Allow the oven to cool to below locking temperature.</li> </ul> </li> </ul>
<p><b>Steam is exhausted through the oven vent.</b></p>	<ul style="list-style-type: none"> <li>• Cooking foods with high moisture produces steam. This is normal.</li> </ul>
<p><b>Appliance does not operate.</b></p>	<ul style="list-style-type: none"> <li>• Make sure cord is plugged correctly into outlet. Check circuit breakers.</li> <li>• Service wiring is not complete. Contact your appliance Servicer for assistance.</li> <li>• Power outage. Check house lights to be sure. Call your local electric company for service.</li> </ul>
<p><b>Oven control displays PF message.</b></p>	<ul style="list-style-type: none"> <li>• The PF message will appear whenever there has been a power interruption to the appliance. To clear the PF message touch CLEAR OFF control pad and be sure to reset the clock with the correct time of day.</li> </ul>
<p><b>Oven light does not work.</b></p>	<ul style="list-style-type: none"> <li>• Replace or tighten bulb. See <b>Changing Oven Light</b> section in this Owner's manual.</li> </ul>
<p><b>Oven smokes excessively during broiling.</b></p>	<ul style="list-style-type: none"> <li>• Control not set properly. Follow instructions under Setting Oven Controls.</li> <li>• Meat too close to the element. Reposition the rack to provide proper clearance between the meat and the element. Preheat broil element for searing.</li> <li>• Meat not properly prepared. Remove excess fat from meat. Cut remaining fatty edges to prevent curling.</li> <li>• Insert on broiler pan wrong side up and grease not draining. Always place grid on the broiler pan with ribs up and slots down to allow grease to drip into pan.</li> <li>• Grease has built up on oven surfaces. Regular cleaning is necessary when broiling frequently. Old grease or food spatters cause excessive smoking.</li> </ul>
<p><b>Food does not bake or roast properly.</b></p>	<ul style="list-style-type: none"> <li>• Oven controls improperly set.                             <ul style="list-style-type: none"> <li>- See the using the oven section.</li> </ul> </li> <li>• Rack position is incorrect or the rack is not level.                             <ul style="list-style-type: none"> <li>- See the using the oven section.</li> </ul> </li> <li>• Incorrect cookware or cookware of improper size being used.                             <ul style="list-style-type: none"> <li>- See the using the oven section.</li> </ul> </li> <li>• Oven sensor needs to be adjusted.                             <ul style="list-style-type: none"> <li>- See the adjusting your oven temperature in option section.</li> </ul> </li> </ul>
<p><b>Food does not broil properly.</b></p>	<ul style="list-style-type: none"> <li>• Oven controls improperly set.                             <ul style="list-style-type: none"> <li>- Make sure you touch the <b>BROIL</b> pad.</li> </ul> </li> <li>• Improper rack position being used.                             <ul style="list-style-type: none"> <li>- See the <b>Broiling Guide</b>, page 26.</li> </ul> </li> <li>• Cookware not suited for broiling.                             <ul style="list-style-type: none"> <li>- Use the broiling pan and grid that came with your range.</li> </ul> </li> </ul>

# TROUBLESHOOTING

## BEFORE CALLING FOR SERVICE (cont')

Problem	Possible Causes / Solutions
<b>Food does not broil properly.</b>	<ul style="list-style-type: none"> <li>• Aluminum foil used on the the broiling pan and grid has not been fitted properly and slit as recommended.               <ul style="list-style-type: none"> <li>- See the Using the Oven section.</li> </ul> </li> <li>• In some areas the power voltage may be low.               <ul style="list-style-type: none"> <li>- Preheat the broil element for 5-7 minutes</li> <li>- See the <b>Broiling Guide</b>, page 26.</li> </ul> </li> </ul>
<b>Oven temperature too hot or too cold.</b>	<ul style="list-style-type: none"> <li>• Oven Sensor needs to be adjusted.               <ul style="list-style-type: none"> <li>- See the adjusting your oven Temperature in option section.</li> </ul> </li> </ul>
<b>Scratches or abrasions on cooktop surface.</b>	<ul style="list-style-type: none"> <li>• Coarse particles such as salt or sand between cooktop and utensils can cause scratches. Be sure cooktop surface and bottoms of utensils are clean before usage. Small scratches do not affect cooking and will become less visible with time.</li> <li>• Cleaning materials not recommended for ceramic-glass cooktop have been used. See <b>Cleaning The Glass Cooktop</b> in the MAINTENANCE section, page 37~39.</li> <li>• Cookware with rough bottom has been used. Use smooth, flat-bottomed cookware.</li> </ul>
<b>Metal marks.</b>	<ul style="list-style-type: none"> <li>• Scraping of metal utensils on cooktop surface. Do not slide metal utensils on cooktop surface. Use a ceramic-glass cooktop cleaning creme to remove the marks. See <b>Cleaning The Glass Cooktop</b> in the MAINTENANCE section, page 37~39.</li> </ul>
<b>Brown streaks or specks.</b>	<ul style="list-style-type: none"> <li>• Boilovers are cooked onto surface. Use the blade scraper to remove soil. See <b>Cleaning The Glass Cooktop</b> in the MAINTAINANCE section, page 37~39.</li> </ul>
<b>Areas of discoloration on cooktop.</b>	<ul style="list-style-type: none"> <li>• Mineral deposits from water and food. Remove using a ceramic-glass cooktop cleaning creme. Use cookware with clean, dry bottoms.</li> </ul>
<b>Oven will not self clean.</b>	<ul style="list-style-type: none"> <li>• The oven temperature is too high to set a self clean operation.               <ul style="list-style-type: none"> <li>- Allow the range to cool and reset the controls.</li> </ul> </li> <li>• Oven controls improperly set.               <ul style="list-style-type: none"> <li>- See the using the self cleaning oven section.</li> </ul> </li> <li>• A self clean cycle cannot be started if the oven lockout feature is active.</li> </ul>
<b>“Crackling” or “popping” sound.</b>	<ul style="list-style-type: none"> <li>• This is the sound of the metal heating and cooling during both the cooking and Self Clean functions.               <ul style="list-style-type: none"> <li>- This is normal.</li> </ul> </li> </ul>
<b>Oven racks are difficult to slide.</b>	<ul style="list-style-type: none"> <li>• Apply a small amount of vegetable oil to a paper towel and wipe the edges of the ovenracks with the paper towel.</li> </ul>



## BEFORE CALLING FOR SERVICE (cont')

Problem	Possible Causes / Solutions
<b>Excessive smoking during a self clean cycle.</b>	<ul style="list-style-type: none"> <li>• Excessive soil.</li> <li>- Press the CLEAR OFF pad. Open the windows to rid the room of smoke. Wait until the self clean mode is cancelled. Wipe up the excess soil and reset the clean.</li> </ul>
<b>Oven door do not open after a self clean cycle.</b>	<ul style="list-style-type: none"> <li>• Oven is too hot.</li> <li>- Allow the oven to cool below locking temperature.</li> </ul>
<b>Oven not clean after a self clean cycle.</b>	<ul style="list-style-type: none"> <li>• Oven controls not properly set.</li> <li>- See the Self Clean section, page 34-36.</li> <li>• Oven was heavily soiled.</li> <li>- Clean up heavy spillovers before starting the clean cycle. Heavily soiled ovens may need to self clean again or for a longer period of time.</li> </ul>
<b>CLEAN and door flash in the display.</b>	<ul style="list-style-type: none"> <li>• The self clean cycle has been selected but the door is not closed.</li> <li>- Close the oven door.</li> </ul>
<b>LOCKED is on in the display when you want to cook.</b>	<ul style="list-style-type: none"> <li>• The oven door is locked because the temperature inside the oven has not dropped below the locking temperature.</li> <li>- Press the CLEAR OFF pad. Allow the oven to cool.</li> </ul>
<b>Burning or oily odor emitting from the vent.</b>	<ul style="list-style-type: none"> <li>• This is normal in a new oven and will disappear in time.</li> <li>- To speed the process, set a self clean cycle for a minimum of 3 hours. See the self clean section, page 34-36.</li> </ul>
<b>Oven racks are difficult to slide.</b>	<ul style="list-style-type: none"> <li>• The shiny, silver-colored racks were cleaned in a self clean cycle.</li> <li>- Apply a small amount of vegetable oil to a paper towel and wipe the edges of the oven racks with the paper towel.</li> </ul>
<b>Oven door will unlock after selfclean cycle.</b>	<ul style="list-style-type: none"> <li>• Oven interior is still hot. Allow about one hour for the oven to cool after the completion of a self clean cycle. The door can be opened when the LOCK indicator word is not displayed.</li> <li>• The control and door may be locked. See pages 33 to unlock.</li> </ul>
<b>Moisture collects on oven window or steam comes from oven vent.</b>	<ul style="list-style-type: none"> <li>• This is normal when cooking foods high in moisture.</li> <li>• Excessive moisture was used when cleaning the window.</li> </ul>

# LG ELECTRIC OVEN LIMITED WARRANTY – USA

LG Electronics Inc. will repair or replace your product, at LG's option, if it proves to be defective in material or workmanship under normal use, during the warranty period set forth below, effective from the date of original consumer purchase of the product. This limited warranty is good only to the original purchaser of the product and effective only when used in U.S.A.

WARRANTY PERIOD:	HOW SERVICE IS HANDLED:
<b>One Year</b> From the date of the original purchase	<b>Any part</b> of the oven which fails due to a defect in materials or workmanship. During this <b>full one-year warranty</b> , LG will also provide, <b>free of charge</b> , all labour and in-home service to replace the defective part.

**THIS WARRANTY IS IN LIEU OF ANY OTHER WARRANTIES, EXPRESS OR IMPLIED, INCLUDING WITHOUT LIMITATION, ANY WARRANTY OF MERCHANTABILITY OR FITNESS FOR A PARTICULAR PURPOSE. TO THE EXTENT ANY IMPLIED WARRANTY IS REQUIRED BY LAW, IT IS LIMITED IN DURATION TO THE EXPRESS WARRANTY PERIOD ABOVE. LG WILL NOT BE LIABLE FOR ANY CONSEQUENTIAL, INDIRECT, OR INCIDENTAL DAMAGES OF ANY KIND, INCLUDING LOST REVENUES OR PROFITS, IN CONNECTION WITH THE PRODUCT. SOME STATES DO NOT ALLOW LIMITATION ON HOW LONG AN IMPLIED WARRANTY LASTS OR THE EXCLUSION OF INCIDENTAL OR CONSEQUENTIAL DAMAGES, SO THE ABOVE LIMITATIONS OR EXCLUSIONS MAY NOT APPLY TO YOU.**

***THIS LIMITED WARRANTY DOES NOT APPLY TO:***

1. Service calls to correct the installation of your appliance, to instruct you how to use your appliance, to replace house fuses or correct house wiring, or to replace owner-accessible light bulbs.
2. Repairs when your appliance is used in other than normal, single-family household use.
3. Pickup and delivery. Your appliance is designed to be repairable in the home.
4. Damage resulting from accident, alteration, misuse, abuse, fire, flood, improper installation, acts of God, or use of products not approved by LG Corporation.
5. Repairs to parts or systems resulting from unauthorized modifications made to the appliance.
6. Replacement parts or repair labour costs for units operated outside the United States.
7. Any labour costs during the limited warranty period.

This warranty is extended to the original purchaser for products purchased for home use within the USA. In Alaska, the warranty excludes the cost of shipping or service calls to your home.

Some states do not allow the exclusion or limitation of incidental or consequential damages, so this exclusion or limitation may not apply to you. This warranty gives you specific legal rights, and you may also have other rights which vary from state to state. To know what your legal rights are, consult your local or state consumer affairs or your state's Attorney General.

***CUSTOMER ASSISTANCE INFORMATION:***

<b>To Prove Warranty Coverage</b>	<b>Retain your Sales Receipt to prove date of purchase.</b> A copy of your Sales Receipt must be submitted at the time warranty service is provided.
<b>To Obtain Nearest Authorized Service Center or Sales Dealer, or to Obtain Product, Customer, or Service Assistance</b>	<b>Call 1-800-243-0000</b> (Phone answered 24 hours - 365 days a year) and choose the appropriate prompt from the menu; or visit our website at: <a href="http://us.lgservice.com">http://us.lgservice.com</a> .



# MEMO





**LG Customer Information Center**

1-800-243-0000 USA, Consumer User  
1-888-865-3026 USA, Commercial User  
1-888-542-2623 CANADA

**Register your product Online!**

[www.lg.com](http://www.lg.com)