



Front-Loading Automatic Washer

PRODUCT MODEL NUMBERS

WFW9150W

Electrical: A 120 volt, 60 Hz., AC only, 15- or 20-amp, fused electrical supply is required. A time-delay fuse or circuit breaker is recommended. It is recommended that a separate circuit serving only this appliance be provided.

Drain System Options

Standpipe drain system - wall or floor (views A & B)
The standpipe drain requires a minimum diameter standpipe of 2" (50 mm). The minimum carry-away capacity can be no less than 17 gal. (64 L) per minute. The top of the standpipe must be at least 30" (762 mm) high and no higher than 96" (2.4 m) from the bottom of the washer.

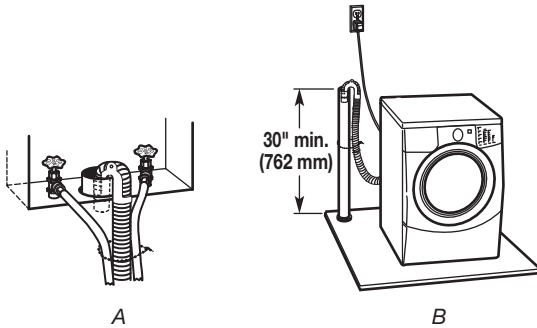

Laundry tub drain system (view C)
The laundry tub needs a minimum 20 gal. (76 L) capacity. The top of the laundry tub must be at least 30" (762 mm) above the floor.

Floor drain system (view D)
The floor drain system requires a siphon break that may be purchased separately. See "Tools and Parts." The siphon break must be a minimum of 28" (710 mm) from the bottom of the washer. Additional hoses might be needed.

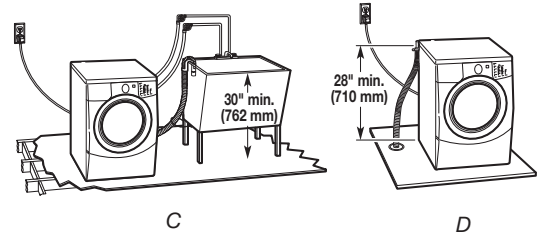

OVERALL DIMENSIONS

Washer dimensions

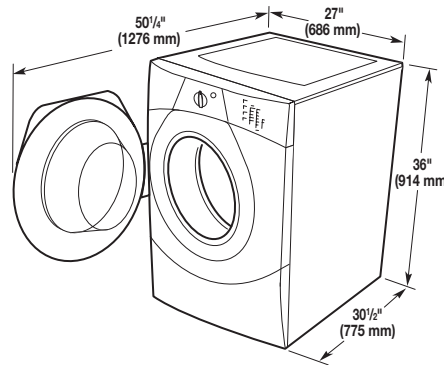

Custom undercounter installation-dryer only

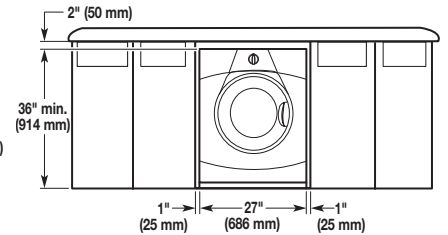

For closet installation, with a door, the minimum ventilation openings in the top and bottom of the door are required. Louvered doors with equivalent air ventilation openings are acceptable.

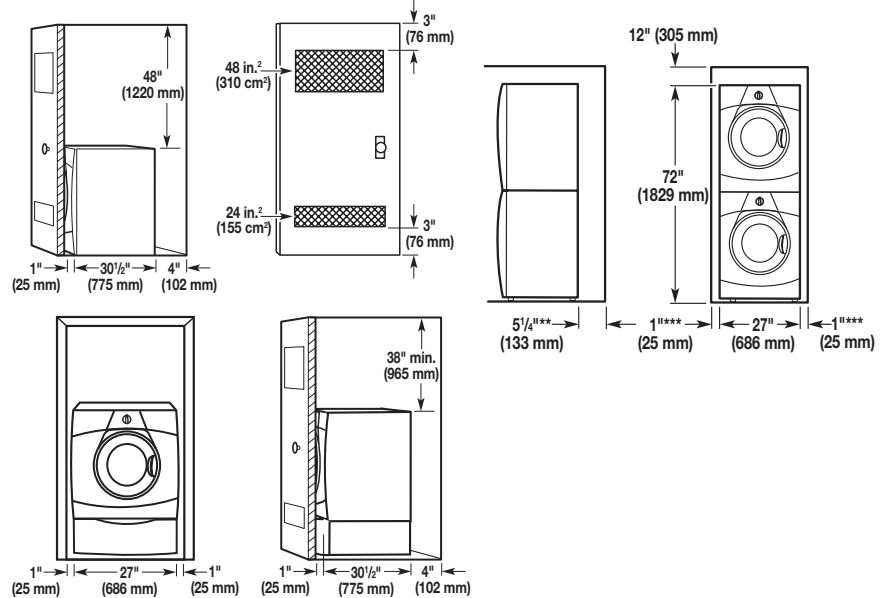

For cabinet installation, with a door, the minimum ventilation openings in the top are required.

