

Installation Instructions

14,000 BTU TTW

Do This First (for existing sleeve)

Note that the air conditioner dimensions are: 24" wide, 14½" high, and 22" deep (without front). Install Air Conditioner according to these installation instructions to achieve the best performance. Save these installation instructions for future reference.

Items in Kit

You may not need all parts in the kit. Discard unused parts.

		Qty.
Tapered Spacer Blocks	17" Long	2
Centering/Support Blocks	4½" x 3½" x 1½"	2
Plastic Divider	1/8" x 4½" x 14½"	1
Stuffer Seal	1" x 1½" x 84"	1
Seal	1½" x 1½" x 25"	2
Seal	1½" x 1½" x 14"	2
Seal	1½" x 3/8" x 25"	2
Seal	1½" x 3/8" x 14"	2
Seal	1" x 3/4" x 14"	1
Trim Frame (side legs)		2
Trim Frame (top & bottom legs)		2
Ground Wire (green)		1
Nut for grounding screw		1
Grounding Screw		1
Grille (plastic)		1
Grille Aluminum		1
Nuts (plastic)		4
Screw w/washer		4

How to Install

1. Identify the wall-sleeve brand for your installation, from the chart below.

Brand	Wall Sleeve Dimensions (inches)		
	Width	Height	Depth
White-Westinghouse Frigidaire Carrier (52F Series) General Electric/ Hotpoint Whirlpool	} 25½	15¼	16, 17½ or 22
			26
	25⅞	16½	17⅞
			or 23
Fedders/Emerson	27	16¾	16¾ or 19¾
Sears/Kenmore	25¾	16⅞	18⅞
Emerson/Fedders	26¾	15¾	15
Carrier (51S Series)	25¾	16⅞	18⅞
Friedrich	27	16¾	16¾

NOTE: All wall sleeves used to mount the new Air Conditioner must be in sound structural condition and have a rear grille that securely attaches to sleeve, or rear flange that serves as a stop for the Air Conditioner.

CAUTION: When installation is complete, replacement unit **MUST** have a rearward slope as shown.

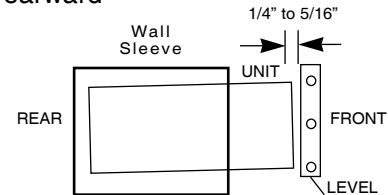

2. Remove old Air Conditioner from wall sleeve and prepare wall sleeve as follows:

- Clean interior (do not disturb seals).
- Wall sleeve must be securely fastened in wall before installing Air Conditioner. Drive more nails or screws through sleeve, into wall, if needed.
- Repair paint if needed.

3. If not existing, drill a 3/16" clearance hole for grounding screw through left side of wall sleeve, in a clear area about 3 inches maximum (to suit) back from front edge of sleeve as shown below. Next attach ground wire inside sleeve, using grounding screw, nut washer pull loose end of ground wire out front of sleeve, and temporarily bend it down and around lower edge of sleeve.

Wall sleeve to unit
sleeve grounding

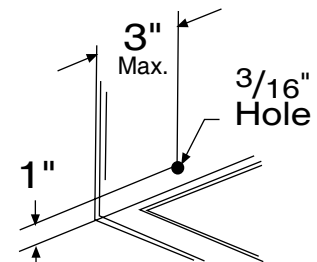

4. Prepare the wall sleeve for installation of the new unit per the following Brand instructions.

- | | |
|---|-----------------|
| #1 Emerson | 15" Deep |
| #2 Fedders | 19¾" Deep |
| #3 Fedders or Friedrich | 16¾" Deep |
| #4 General Electric/Hotpoint | 16⅞" Deep |
| #5 Sears or Carrier (51S Series) | 18⅝" Deep |
| #6 Whirlpool | 17⅞" Deep |
| #7 Whirlpool | 23" Deep |
| #8 White-Westinghouse/Frigidaire/
Carrier (52F Series) | 16" + 17½" Deep |
| #9 White-Westinghouse/Frigidaire | 22" Deep |

5. Install new unit into wall sleeve.

6. To attach ground wire to the new unit, remove the screw from the left side front.

7. Assemble and install the Trim Frame (see instruction).

This units increased performance characteristics meant;

1. The rear air intake moved to the opposite side.
2. The depth had to be increased.

It is very important that these installation instructions are followed so your unit can operate at maximum efficiency.

If this is an existing sleeve, and there is an existing rear grille, the louvers will have to be bent as per the instructions at the beginning of each section.

If this proves too difficult to accomplish;

EITHER

1. Remove the existing grille.
2. Place the included aluminum grille towards the rear of the unit.
3. Mark through the hole positions.
4. Drill through the sleeves flanges with a 1/8" drill bit.
5. Attached the new grille with self-threading screws and washers (not included).
6. It is VERY IMPORTANT that the partition be placed on the left side of the sleeve as shown below.



OR

1. Remove the existing grille.
2. Use Plastic grille and secure to sleeves flanges using existing screws and washers.

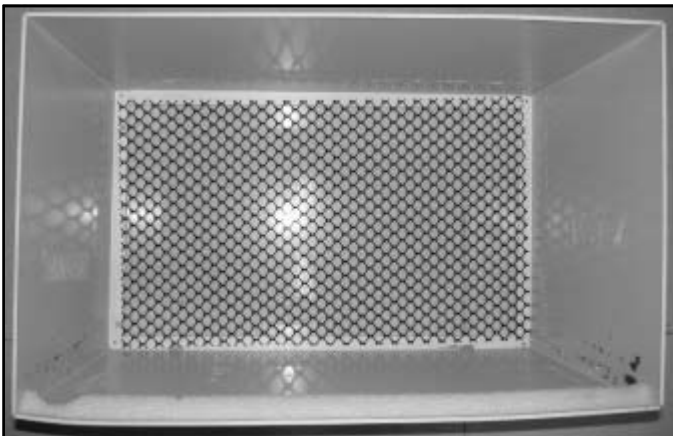

Wall Sleeve Brands:

#1 Emerson

15" Deep

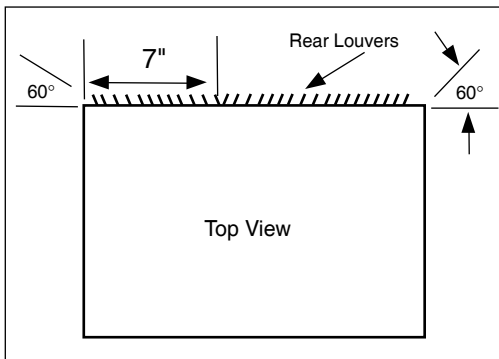

1. Redirect the louvers at the back of the wall sleeve as shown opposite. The use of pliers is recommended.

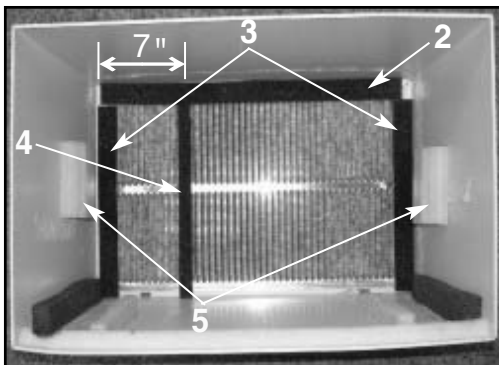

2. Attach (1) 1 1/2" x 3/8" x 25" long seal in the center at the top of the sleeve. Remove the backing paper and press into position.
3. Attach (2) 1 1/2" x 3/8" x 14" seals to the left and right sides of the sleeve.
4. Cut the 1 1/2" x 3/8" x 25" long seal to 14" long and attach it to the vertical section of the rear grille as shown.
5. Attach (2) 4 1/2" x 3 1/2" x 1 1/2" centering/support blocks one on each side wall. Place in center of side wall with the tapered end facing the opening.
6. Gently slide unit into sleeve.
7. Before sliding all-the-way back, remove 2nd screw from front on left side of unit.
8. Remove the plastic washer from the screw.
9. Screw and attach the other end of the ground wire to the unit as shown in picture. Make sure that the toothed washer is against the cabinet.
10. Slide the unit completely to the rear to ensure a good seal, making sure the ground wire does not become tangled.
11. Seal & Frame the unit as described on the last page of these instructions.



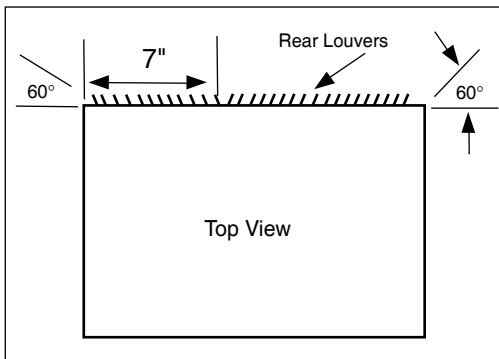

1. Redirect the louvers at the back of the wall sleeve as shown opposite. The use of pliers is recommended.

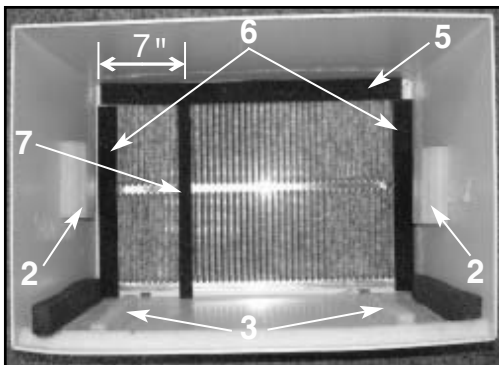

2. Attach (2) 4 1/2" x 3 1/2" x 1 1/2" centering/support blocks one on each side wall. Place in center of side wall with the tapered end facing the opening.
3. Cut (2) 17" Tapered Spacer Blocks as shown below into two pieces.

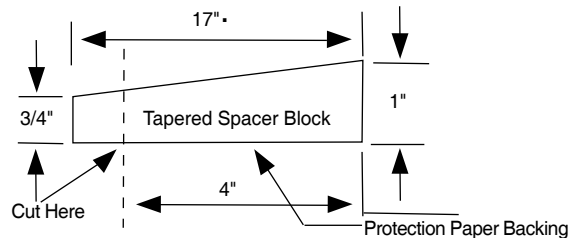

4. The 4" section is placed in front of the rib on base with the tapered end facing the back of the sleeve. The remaining portion will be placed behind the rib again sloping toward the rear of the sleeve. This helps induce a rearward slope on the unit.
5. Attach (1) 1 1/2" x 3/8" x 25" long seal in the center at the top of the sleeve. Remove the backing paper and press into position.
6. Attach (2) 1 1/2" x 3/8" x 14" seals to the left and right sides of the sleeve.
7. Cut the 1 1/2" x 3/8" x 25" long seal to 14" long and attach it to the vertical section of the rear grille as shown.
8. Gently slide unit into sleeve.
9. Before sliding all-the-way back, remove 2nd screw from front on left side of unit.
10. Remove the plastic washer from the screw.
11. Screw and attach the other end of the ground wire to the unit as shown in picture. Make sure that the toothed washer is against the cabinet.
12. Slide the unit completely to the rear to ensure a good seal, making sure the ground wire does not become tangled.
13. Seal & Frame the unit as described on the last page of these instructions.

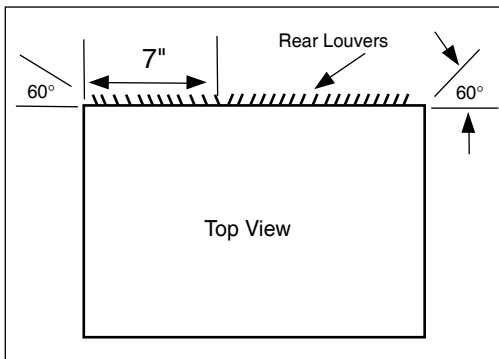

1. Redirect the louvers at the back of the wall sleeve as shown opposite. The use of pliers is recommended.

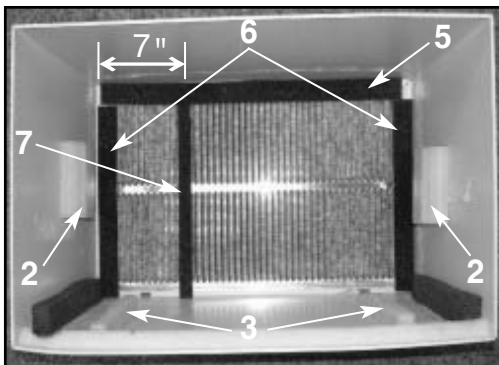

2. Attach (2) 4 1/2" x 3 1/2" x 1 1/2" centering/support blocks one on each side wall. Place in center of side wall with the tapered end facing the opening.
3. Cut (2) 17" Tapered Spacer Blocks as shown below into three pieces.

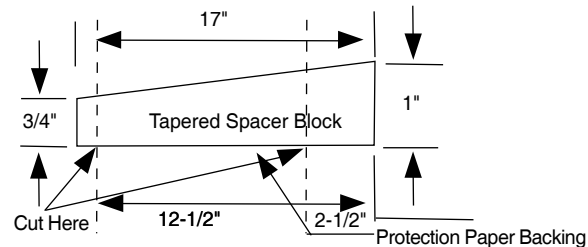

4. The 2 1/2" section is placed in front of the rib on base with the tapered end facing the back of the sleeve. Cut the remaining portion to 12 1/2" and place behind the rib again sloping toward the rear of the sleeve. This helps induce a rearward slope on the unit.
5. Attach (1) 1 1/2" x 3/8" x 25" long seal in the center at the top of the sleeve. Remove the backing paper and press into position.
6. Attach (2) 1 1/2" x 3/8" x 14" seals to the left and right sides of the sleeve.
7. Cut the 1 1/2" x 3/8" x 25" long seal to 14" long and attach it to the vertical section of the rear grille as shown.
8. Gently slide unit into sleeve.
9. Before sliding all-the-way back, remove 2nd screw from front on left side of unit.
10. Remove the plastic washer from the screw.
11. Screw and attach the other end of the ground wire to the unit as shown in picture. Make sure that the toothed washer is against the cabinet.
12. Slide the unit completely to the rear to ensure a good seal, making sure the ground wire does not become tangled.
13. Seal & Frame the unit as described on the last page of these instructions.

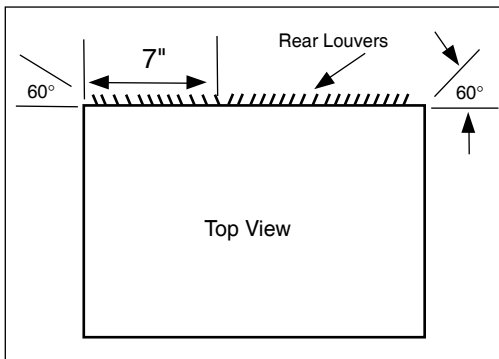

1. Redirect the louvers at the back of the wall sleeve as shown opposite. The use of pliers is recommended.

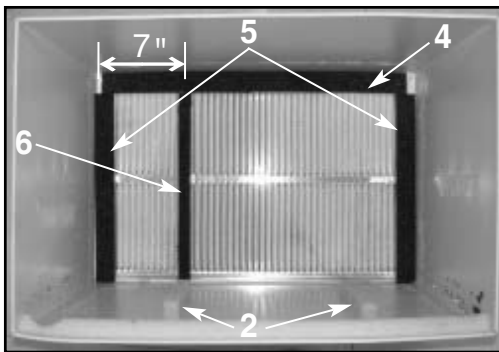

2. Cut (2) 17" Tapered Spacer Blocks as shown below into two pieces.

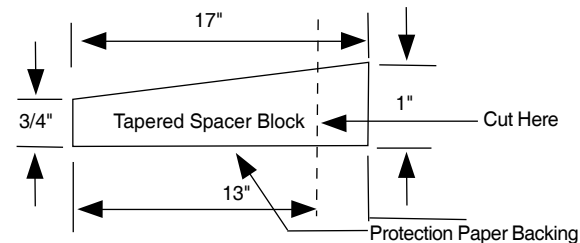

3. Install as shown with the tapered end 1/2" from the back of the sleeve. This helps induce a rearward slope on the unit.
4. Attach (1) 1 1/2" x 3/8" x 25" long seal in the center at the top of the sleeve. Remove the backing paper and press into position.
5. Attach (2) 1 1/2" x 3/8" x 14" seals to the left and right sides of the sleeve.
6. Cut the 1 1/2" x 3/8" x 25" long seal to 14" long and attach it to the vertical section of the rear grille as shown.
7. Center unit & gently slide unit into sleeve.
8. Before sliding all-the-way back, remove 2nd screw from front on left side of unit.
9. Remove the plastic washer from the screw.
10. Screw and attach the other end of the ground wire to the unit as shown in picture. Make sure that the toothed washer is against the cabinet.
11. Slide the unit completely to the rear to ensure a good seal, making sure the ground wire does not become tangled.
12. Seal & Frame the unit as described on the last page of these instructions.



Wall Sleeve Brands:

#5 Sears or Carrier 51S Series

18 5/8" Deep

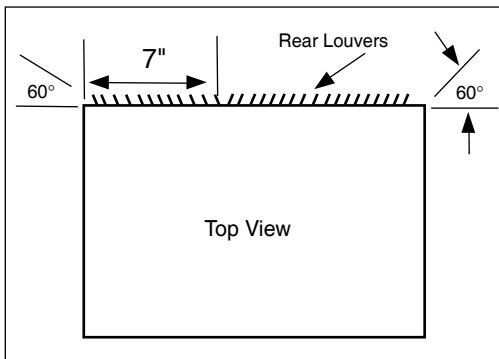

1. Redirect the louvers at the back of the wall sleeve as shown opposite. The use of pliers is recommended.

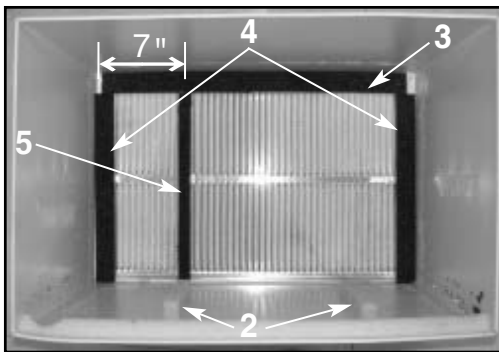

2. Install (2) tapered spacer blocks to the floor of the sleeve as shown. **DO NOT CUT THESE BLOCKS.** This helps induce a rearward slope on the unit.
3. Install as shown with the tapered end 1/2" from the back of the sleeve. This helps induce a rearward slope on the unit.
4. Attach (1) 1 1/2" x 3/8" x 25" long seal in the center at the top of the sleeve. Remove the backing paper and press into position.
5. Attach (2) 1 1/2" x 3/8" x 14" seals to the left and right sides of the sleeve.
6. Cut the 1 1/2" x 3/8" x 25" long seal to 14" long and attach it to the vertical section of the rear grille as shown.
7. Center unit & gently slide unit into sleeve.
8. Before sliding all-the-way back, remove 2nd screw from front on left side of unit.
9. Remove the plastic washer from the screw.
10. Screw and attach the other end of the ground wire to the unit as shown in picture. Make sure that the toothed washer is against the cabinet.
11. Slide the unit completely to the rear to ensure a good seal, making sure the ground wire does not become tangled.
12. Seal & Frame the unit as described on the last page of these instructions.



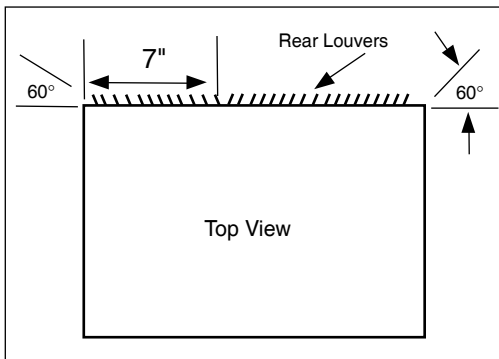

1. Redirect the louvers at the back of the wall sleeve as shown opposite. The use of pliers is recommended.

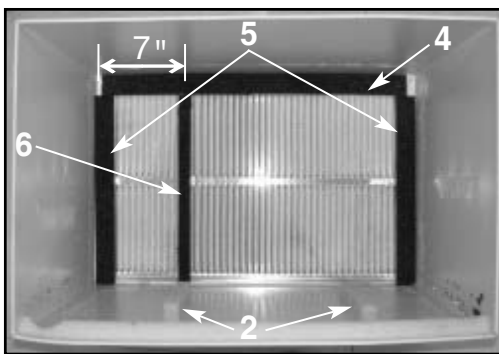

2. Cut (2) 17" Tapered Spacer Blocks as shown below into two pieces.

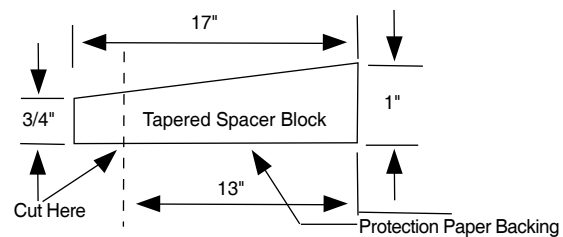

3. Install to the floor of the sleeve as shown. This helps induce a rearward slope on the unit.
4. Attach (1) 1 1/2" x 3/8" x 25" long seal in the center at the top of the sleeve. Remove the backing paper and press into position.
5. Attach (2) 1 1/2" x 3/8" x 14" seals to the left and right sides of the sleeve.
6. Cut the 1 1/2" x 3/8" x 25" long seal to 14" long and attach it to the vertical section of the rear grille as shown.
7. Center unit & gently slide unit into sleeve.
8. Before sliding all-the-way back, remove 2nd screw from front on left side of unit.
9. Remove the plastic washer from the screw.
10. Screw and attach the other end of the ground wire to the unit as shown in picture. Make sure that the toothed washer is against the cabinet.
11. Slide the unit completely to the rear to ensure a good seal, making sure the ground wire does not become tangled.
12. Seal & Frame the unit as described on the last page of these instructions.



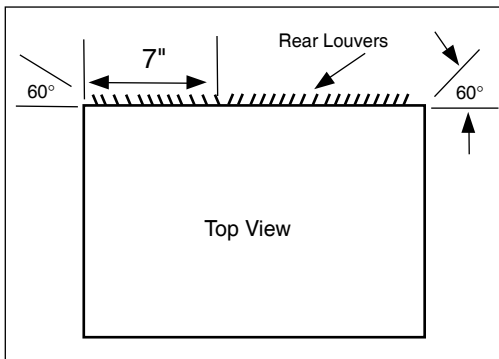

1. Redirect the louvers at the back of the wall sleeve as shown opposite. The use of pliers is recommended.

Because of the increased unit depth, first try dry fitting using the method described below:

1. Place (2) 1 1/2" x 1 1/2" x 14" seals against each side.
2. Gently slide unit in and check if amount extending from the sleeve is sufficient once the trim frame is attached.
3. If position is okay, remove unit and Proceed to the next step. If not go to step 8.
4. Attach (1) 1 1/2" x 1 1/2" x 25" long seal in the center at the top of the sleeve. Remove the backing paper and press into position.
5. Attach (2) 1 1/2" x 1 1/2" x 14" seals to the left and right sides of the sleeve.
6. Cut the 1 1/2" x 1 1/2" x 25" long seal to 14" long and attach it vertically to the rear grill 7" from the left side.
7. Attach the tapered spacer blocks to the floor of the sleeve. Now go to step 13.

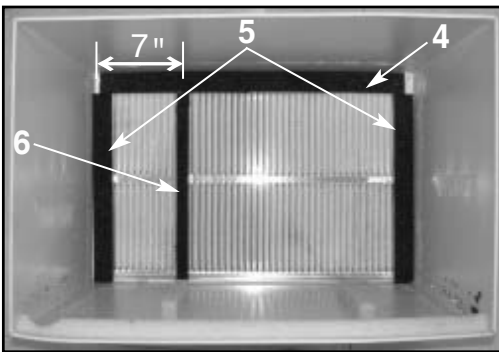

Use these next steps if the unit requires extra extension into the room.

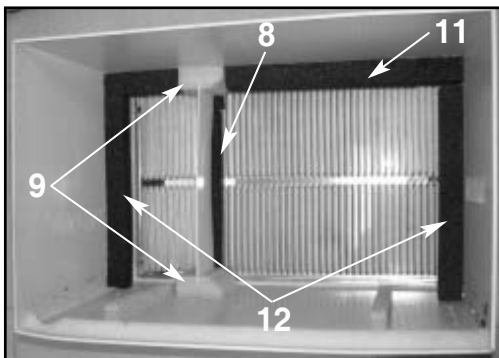

8. Attach 1" x 3/4" x 14" long seal over the solid vertical portion of the rear grille.
9. Attach (2) 4 1/2" x 3 1/2" x 1 1/2" foam blocks with the slot overlapping the seal above.
10. Install the divider into the slots of the foam blocks. You may need to trim the length to size.
11. Cut the 1 1/2" x 1 1/2" x 25" seal to fit the top of the sleeve. The pieces must be fitted flush to the edge of the divider.
12. Attach (2) 1 1/2" x 1 1/2" x 14" seals along the sides of the sleeve again making sure all seals are flush.
13. Center unit & gently slide unit into sleeve.
14. Before sliding all-the-way back, remove 1st screw from front on left side of unit.
15. Remove the plastic washer from the screw.
16. Screw and attach the other end of the ground wire to the unit as shown in picture. Make sure that the toothed washer is against the cabinet.
17. Slide the unit completely to the rear to ensure a good seal, making sure the ground wire does not become tangled.
18. Seal & Frame the unit as described on the last page of these instructions.



Wall Sleeve Brands:

#8 White Westinghouse/Frigidaire/
Carrier 52F Series

16" + 17 1/2" Deep



1. If the wall sleeve does not have a rear grille or louvered panel, install the plastic grille from the kit. The plastic grille is mounted to the inside of the wall sleeve at the rear flanges. There are (4) plastic nuts in the flanges of the wall sleeve. If some are missing replacements are included in the accessory kit, and can be simply pressed into the square holes in the flanges. Place the grille against the rear flanges and use the (4) large washers and screws to secure the grille.

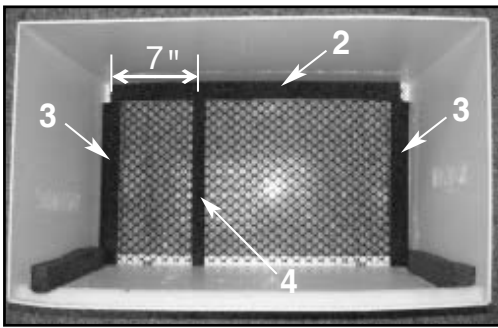

2. Attach (1) 1 1/2" x 3/8" x 25" long seal in the center at the top of the sleeve. Remove the backing paper and press into position.
3. Attach (2) 1 1/2" x 3/8" x 14" seals to the left and right sides of the sleeve.
4. Attach 1" x 3/4" 14" long seal vertically 7" from the left side of the sleeve.
5. Center unit & gently slide unit into sleeve.
6. Before sliding all-the-way back, remove 2nd screw from front on left side of unit.
7. Remove the plastic washer from the screw.
8. Screw and attach the other end of the ground wire to the unit as shown in picture. Make sure that the toothed washer is against the cabinet.
9. Slide the unit completely to the rear to ensure a good seal, making sure the ground wire does not become tangled.
10. Seal & Frame the unit as described on the last page of these instructions.



Wall Sleeve Brands:

#9 White Westinghouse or Frigidaire

22" Deep

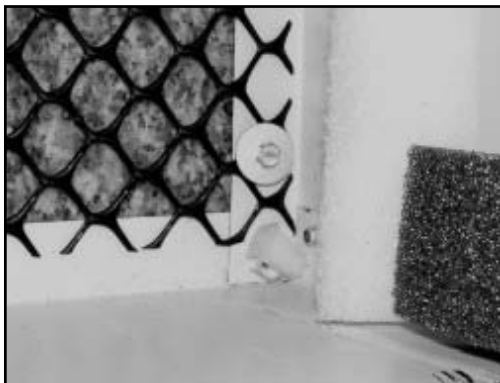

1. If the wall sleeve does not have a rear grille or louvered panel, install the plastic grille from the kit. The plastic grille is mounted to the inside of the wall sleeve at the rear flanges. There are (4) plastic nuts in the flanges of the wall sleeve. If some are missing replacements are included in the accessory kit, and can be simply pressed into the square holes in the flanges. Place the grille against the rear flanges and use the (4) large washers and screws to secure the grille.

Because of the increased unit depth, first try dry fitting using the method described below:

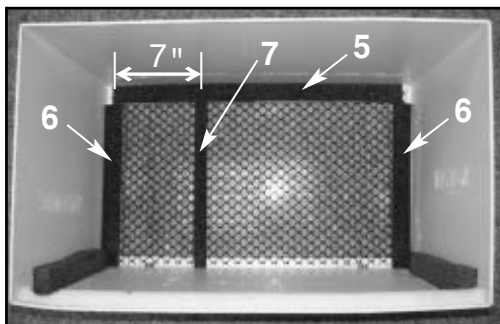

2. Place (2) 1 1/2" x 1 1/2" x 14" seals against each side.
3. Gently slide unit in and check if amount extending from the sleeve is sufficient once the trim frame is attached.
4. If position is okay, remove unit and Proceed to the next step. If not go to step 8.
5. Attach (1) 1 1/2" x 1 1/2" x 25" long seal in the center at the top of the sleeve. Remove the backing paper and press into position.
6. Attach (2) 1 1/2" x 1 1/2" x 14" seals to the left and right sides of the sleeve.
7. Cut the 1 1/2" x 1 1/2" x 25" long seal to 14" long and attach it vertically to the rear grill 7" from the left side.

Use the next steps if the unit requires extra extension into the room.

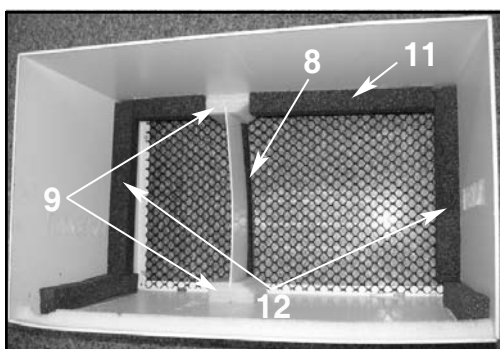

8. Attach 1" x 3/4" 14" long seal over the solid vertical portion of the rear grille.
9. Attach (2) 4 1/2" x 3 1/2" x 1 1/2" foam blocks with the slot overlapping the seal above.
10. Install the divider into the slots of the foam blocks. You may need to trim the length to size.
11. Cut to fit the 1 1/2" x 1 1/2" x 25" seal to fit the top of the sleeve. The pieces must be fitted flush to the edge of the divider.
12. Attach (2) 1 1/2" x 1 1/2" x 14" seals along the sides of the sleeve again making sure all seals are flush.
13. Center unit & gently slide unit into sleeve.
14. Before sliding all-the-way back, remove 1st screw from front on left side of unit.
15. Remove the plastic washer from the screw.
16. Screw and attach the other end of the ground wire to the unit as shown in picture. Make sure that the toothed washer is against the cabinet.
17. Slide the unit completely to the rear to ensure a good seal, making sure the ground wire does not become tangled.
18. Seal & Frame the unit as described on the last page of these instructions.

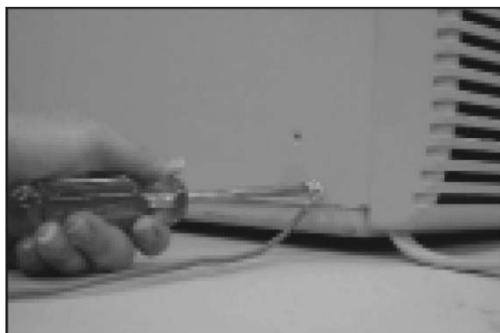

FINISHING INSTALLATION:



1. Install the 1" x 1 1/2" x 84" long stuffer-seal between the wall-sleeve and the unit. A flat-bladed screwdriver or putty knife is recommended.



2. Assemble the trim frame by inserting top and bottom pieces into side pieces and snapping into place.



3. Pull cord through trim frame then slide over unit until flush with wall.