

Washer Operating Instructions

MANUFACTURER
MODEL NUMBER
LNC6766

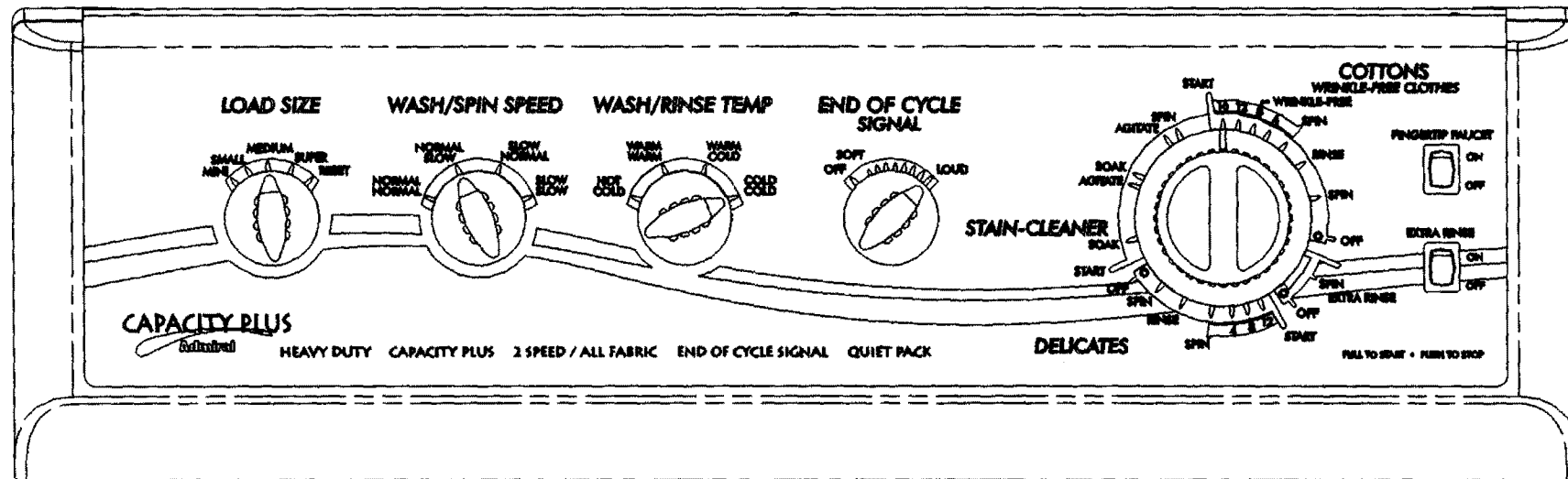

▲WARNING: To reduce the risk of fire, explosion, electric shock, or personal injury, read the **IMPORTANT SAFETY INSTRUCTIONS** before operating your washer.

READ THESE OPERATING INSTRUCTIONS CAREFULLY BEFORE YOU USE THE WASHER AND RETAIN FOR FUTURE REFERENCE.

Before operating your washer, be sure that all installation requirements are met. SEE INSTALLATION INSTRUCTIONS.

TO OPERATE:

Be sure washer drain hose is in drain. Water fill hoses should be attached and faucets fully opened.

1. **LOAD BLEACH DISPENSER**, if desired (maximum one cup).

▲CAUTION: Never pour chlorine bleach directly onto clothes.

2. **MEASURE DETERGENT**, place in washer basket.

3. **DEPRESS FINGERTIP FAUCET** if desired – provides cold water to pretreat spots, stains or heavily soiled areas without washer being in operation. Feature can be used as a cold water source to water flowers, pets, etc.

4. **LOAD CLOTHES** loosely in washer. Maximum load is to top of agitator vanes.

5. **LOAD LIQUID DISPENSER**, if desired.

6. **SELECT WATER TEMPERATURE.** Your Automatic Washer gives you a choice of hot, warm, or cold water for washing and cold or warm water for rinsing.

Hot Wash – Cold Rinse
Warm Wash – Warm Rinse
Warm Wash – Cold Rinse
Cold Wash – Cold Rinse

7. **SELECT SPEED COMBINATION.** Your washer has four wash and spin speed combinations.

8. **SELECT LOAD SIZE.** Determine the selected setting based on clothes load size (see table). Selection should provide sufficient water to permit clothes to circulate during agitation.

It may become necessary, due to bulky fabrics, to adjust the water level after agitation begins. To adjust for a higher water level, turn control to **RESET** position and then back to desired setting. To decrease rinse water level, turn the control to a lower setting after wash agitation has started.

WATER LEVEL SETTING LOAD SIZE

SUPER	3/4 – Full
MEDIUM	1/2 – 3/4 Full
SMALL	1/4 – 1/2 Full
MINI	1/4 Full

REMEMBER: Items must circulate freely for best results.

9. **SELECT CYCLE.** To set Cycle Timer, push the Timer Knob **IN** (off position) and turn it to the right (clockwise) until the pointer is at the recommended starting point in the “wash”

segment in either the Delicates, Cottons/Wrinkle-Free Clothes or Stain-Cleaner/Cottons Cycle. Extra Rinse can be selected for bulky items if desired. See washing program on the underside of the washer lid. **CLOSE LID.**

10. **PULL TIMER KNOB OUT TO START.** You may stop the washer at any time by simply pushing the Timer Knob **IN**. Therefore, it is possible to obtain a non-agitated soak for as long as you wish, or to shorten, skip or repeat any part of a cycle. The Timer Knob must be pushed **IN** (off position) when you change the setting.

NOTE: Do not attempt to turn the Timer Knob counterclockwise since damage to the timer will result.

11. **STOPS AUTOMATICALLY** when wash cycle is completed.

12. **END OF CYCLE SIGNAL.** A buzzer will sound to alert you to the end of the cycle. The buzzer may be adjusted for degree of loudness or turned off.

13. **TURN OFF FAUCETS** when not using washer. This is to protect the water fill hose against excessive pressure.

Features

WASH CYCLE

COTTONS/WRINKLE-FREE CLOTHES

COTTONS consists of 16 minutes of agitation. You may set the timer knob at any point between 4 to 16 minutes for complete flexibility.

WRINKLE-FREE setting with speed selection of **NORMAL/SLOW** and temperature set at **WARM/COLD** will give you a wash cycle for Permanent Press garments.

DELICATES CYCLE

DELICATES consists of 12 minutes of agitation followed by a cool-down spray rinse for Delicate Fabrics. A shorter spin follows.

STAIN-CLEANER eliminates the inconvenience of wash tub soaking of stained clothes before the wash cycle. **Stain-Cleaner** eliminates the need for pre-spot products while providing comparable stain removal performance. Add liquid or granular detergent (step 2), then place liquid detergent in the liquid dispenser (step 4). Clothes soak for 30 minutes with several brief periods of agitation. Water is spun out and clean wash water is added along with detergent for a 16 minute wash.

Stain-Cleaner must be selected on the **TIMER KNOB**. Otherwise, the detergent will be spun out in the rinse water.

Select **WARM/WARM** on the **TEMPERATURE SELECTOR** to provide a warm water soak, a warm wash, and a warm rinse. Set speed for normal agitation and spin speeds. Use this cycle with polyesters and blends (check manufacturer's recommendations). Grass, ketchup, soil, and juices are among the stains that respond well to this type of treatment.

Select **HOT/COLD** on the **TEMPERATURE SELECTOR** for a hot water soak, hot wash, and a cold rinse.

Set speed for normal agitation and spin speeds. This cycle is recommended for most cotton fabrics (check manufacturer's labels). Use for diapers, baby formula, cosmetics and most oil-based stains.

EXTRA RINSE provides an additional rinse and spin out for bulky items such as blankets and spreads. Water temperature and speed will be the same as selected for the Regular Rinse.

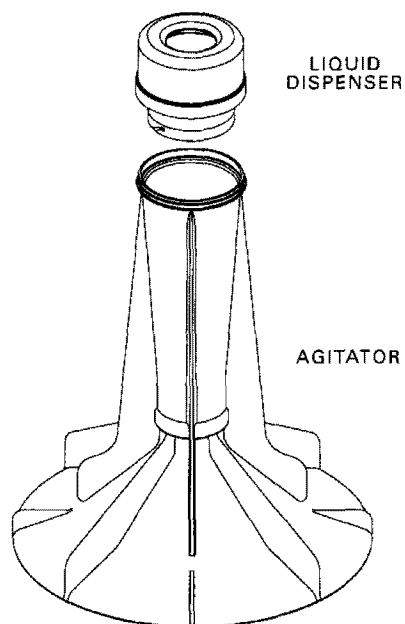

LINT FILTERING SYSTEM (AUTOMATIC)

The Lint Filtering system does not require cleaning.

Wash and rinse water is filtered and re-filtered continuously to trap lint shed by most fabrics during agitation cycle before it can be re-deposited on the wash load. The engineered hole design on the wash basket in conjunction with water flow produced by the agitator traps lint away from the clothes between the inner wash basket and outer tub. Lint is automatically flushed from the washer during the spin cycle.

LIQUID DISPENSER

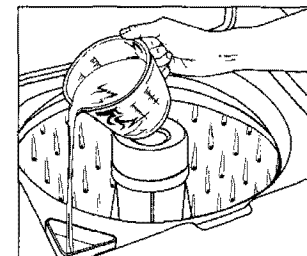
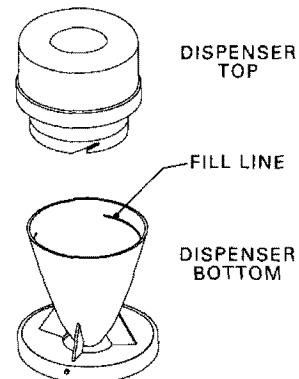

Pour liquid chlorine bleach into bleach dispenser.

The Bleach Dispenser requires no special care for cleaning. However, to avoid damage to chromed and painted surfaces, any spilled bleach should be rinsed off immediately with clean water.

SAFETY SPIN

If for any reason you open the washer lid when the washer is in a **SPIN** or **EXTRACT** period, the operation will immediately stop. **THIS IS FOR YOUR PERSONAL SAFETY. IF YOUR WASHER DOES NOT STOP, CALL YOUR SERVICEMAN IMMEDIATELY.**

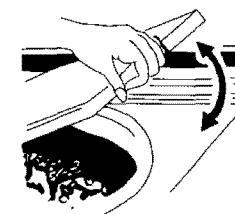

When the lid is closed, the operation will automatically be resumed.

SPIN DRYING

UNBALANCED SPIN LOAD COMPENSATOR

Your new washer is designed to handle out-of-balance loads without shutting down or interrupting the washing cycle.

For this reason, the cycle will always be completed. If heavier fabrics in such out-of-balance loads should ever contain excessive moisture at the completion of the cycle, redistribute the clothes in the washer and reset the Cycle Control for an extra spin.

The dispenser may be used for fabric conditioner with regular cycles or liquid detergent with the **Stain-Cleaner** cycles. Dispenser should be cleaned after use of liquid detergent.

Following the manufacturer's instructions, pour a measured amount of liquid into inner chamber to fill line only. If liquid used comes below line, add water. The dispenser will release the liquid at the appropriate time in the cycle.

If it becomes necessary to clean dispenser, hold dispenser with bottom side up and twist until tabs are disengaged from locking slots. You are then able to clean both parts using warm water and a brush if necessary.

To reassemble, hold both pieces in an upright position. Insert the inner chamber into outer chamber and position tabs into slots. Rotate until tabs snap into locking position.

LIQUID BLEACH DISPENSER

A convenient Bleach Dispenser is built into your washer which makes it easy and safe to use liquid chlorine bleach when it is needed. Load the Dispenser (maximum one cup) **BEFORE YOU LOAD THE CLOTHES INTO THE WASHER.**

The Bleach Dispenser is located at the left front corner of the door opening on the cabinet top.

OVERLOAD PROTECTOR

A built-in protector automatically shuts off the washer motor in case of an overload. This can occur if:

- Too heavy a load is being washed.
- Too many appliances are plugged into the line operating your washer.
- A low voltage condition exists on the line.
- Lid is opened and closed repeatedly.

The overload protector permits the washer to start again when the motor has cooled to a safe operating temperature.

If the motor stops repeatedly, call your company service technician.

Service Nationwide

HOW TO OBTAIN REPLACEMENT PARTS AND SERVICE

The merchandise you have purchased from us has been carefully engineered and manufactured under the company's rigid quality standards and should give you satisfactory and dependable operation. However, like all mechanical merchandise, it may occasionally require adjustment, replacement parts or maintenance. Should you ever need technical assistance or parts, please contact or write your nearest company Store or Product Service Center.

PROVIDE THE FOLLOWING:

1. Model, serial number and all of the other data shown on the model plate.
2. The date and the company store from which you purchased your merchandise.
3. State briefly the trouble you are having.

Replacement Parts will be made available at current prices. If requested, prices will be quoted in advance when not listed.

If you order parts by mail, you will pay the transportation charges from the shipping point.

When you need a replacement part or accessory for a major appliance, home electronic item or lawn and garden product that is not under warranty or covered by a service contract, or if you need the location of the nearest service facility, call our Parts Sales Center Toll Free 1-800-323-1965.

12 MONTHS OF EXTRA SERVICE WITH A COMPANY SERVICE CONTRACT

Now, you can enjoy an additional twelve months' protection after your original warranty expires. For just pennies a day, you are guaranteed unlimited parts and labor for a full year. Call or write your nearest company store for complete information. No obligation, of course.



1. Check hoses to be sure there are no kinks or knots.
2. Your washer should not be installed or stored where temperature will go below freezing, as damage to the washer could result.
3. Occasionally wipe exterior with a clean damp sponge or cloth. Polish with a soft dry cloth.
4. Lifetime lubrication is done at the factory, so your washer never needs to be oiled or greased.

5. Do not lay heavy or sharp objects on top of your washer.
6. The top of the washer should not be used for removing stains from garments. Some stain removers, such as rust remover, will mar the finish.
7. Remove pins, buckles or other sharp objects from clothes to prevent scratching interior parts.
8. Clothes should not be stored in washer.
9. Bleach, detergent, solvents, etc. spilled on the top of your washer that are allowed to remain will remove the glossy finish. Remove all spills with a damp, soft cloth.
10. If you close your home for the winter, have a serviceman drain the washer. Unplug cord from electric outlet and disconnect hoses from faucets.

KEY FACTS: AUTOMATIC WASHERS

BRAND NAME: ADMIRAL
MODEL NO.: LNC6766
TYPE: TOP LOADING

DIMENSIONS:

Cabinet Height: 36" (91.4 cm)
w/Backguard: 44" (111.7 cm)
w/Lid Open: 54" (137.2 cm)
Width: 27" (68.5 cm)
Depth: 27" (68.5 cm)

ELECTRICAL REQUIREMENTS:

Volts: 120V
Amps: 11.5
Hertz: 60 Hz
Three-prong grounding receptacle: Yes
Fuse Size: 15 amp.
time delay

Water Consumption/Normal Cycle (maximum and minimum fills)
Max. - 47 Gal. Min. - 20 Gal.

Description of water temperature selection:

4 Combinations:
Hot Wash — Cold Rinse
Warm Wash — Warm Rinse
Warm Wash — Cold Rinse
Cold Wash — Cold Rinse

Number, types of—

Spin speeds: Normal - 620 R.P.M.
Slow - 412 R.P.M.
Wash speeds: Normal - 88 O.P.M.
Slow - 58 O.P.M.

4 Speed Combinations:

Normal Agitation - Normal Spin
Normal Agitation - Slow Spin
Slow Agitation - Normal Spin
Slow Agitation - Slow Spin

FINISHES -

Wash Basket: Polypropylene
Collector Tub: Polypropylene
Top Surface: Organic Finish
Loading Door: Organic Finish
Cabinet: Painted

Dispensers Available (indicate yes or no)

Detergent No
Bleach Yes
Liquid Dispenser Yes

WEIGHT: 156 lbs.

Listed by Underwriters Laboratories

Safety Precautions

IMPORTANT SAFETY INSTRUCTIONS FOR THE OPERATION OF YOUR CLOTHES WASHER

▲ WARNING: TO REDUCE THE RISK OF FIRE, EXPLOSION, ELECTRIC SHOCK, OR PERSONAL INJURY WHEN USING YOUR WASHER, FOLLOW BASIC SAFETY PRECAUTIONS INCLUDING THE FOLLOWING:

1. READ ALL INSTRUCTIONS CAREFULLY BEFORE USING THE WASHER. RETAIN ALL INSTRUCTIONS FOR FUTURE REFERENCE.

2. PROPERLY INSTALL AND LOCATE in accordance with the Installation Instructions.

MUST BE PROPERLY GROUNDED – See Installation Instructions.

SHOULD ANYONE get an ELECTRIC SHOCK from the washer, disconnect electrical power. DO NOT OPERATE until it has been repaired by a qualified service technician.

INSTALL OR STORE where it will NOT be exposed to temperatures below freezing or exposed to the weather.

CONNECT to a properly rated, protected, and sized power supply circuit. See Electrical Requirements.

CONNECT to adequate plumbing and drain facilities.

HAVE A QUALIFIED SERVICE TECHNICIAN install your washer.

3. TO PREVENT INJURY TO CHILDREN:

DO NOT ALLOW children to play inside, on, or with the washer.

CLOSE SUPERVISION of children is necessary when using washer.

WHEN CHILDREN are mature enough, instruct them in the safe, correct use of the washer.

KEEP ALL LAUNDRY AIDS out of the reach of children, preferably in a locked cabinet. USE laundry aids only as directed by manufacturer, observing all warnings on container labels.

DESTROY THE CARTON AND PLASTIC BAGS after unpacking the washer. Cartons covered with rugs, bedspreads, or plastic sheet can create a chamber with inadequate ventilation.

REMOVE THE DOOR to the washing compartment before the washer is removed from service or discarded.

4. DO NOT REACH INTO the washer if the tub or agitator is moving. The washer is equipped with a safety switch for your protection. If action does not stop when the washer lid is opened during the Spin Cycle, disconnect the electrical power to the washer. Do not operate the washer until it has been repaired by a qualified service technician.

5. DO NOT TAMPER with the Operating Controls.

6. TO PREVENT PERSONAL INJURY and damage to the washer, DO NOT repair or replace any part of the washer or attempt any servicing. SERVICING should be referred to a qualified service technician.

7. DO NOT WASH FIBERGLASS ARTICLES unless recommended by manufacturer.

8. FLAME RETARDANT FINISHES – improper laundering could remove them. FOLLOW garment manufacturer's instructions carefully.

9. WHEN MOVING, have the washer checked and properly installed by a qualified service technician.

▲ WARNING

10. DO NOT ADD gasoline, dry-cleaning solvents, or other flammable or explosive substances to the wash water. These substances give off vapors that could ignite or explode.

11. DO NOT WASH ARTICLES which have been previously cleaned, washed, soaked, or spotted with gasoline, dry-cleaning solvents, oil, waxes, chemical solvents, alcohol, turpentine, or other flammable or explosive materials. These substances will be retained in articles, and articles which still contain these flammable or explosive substances give off vapors that could ignite or explode.

12. OBSERVE THESE PRECAUTIONS WHEN USING CLEANING FLUIDS, SPOT OR STAIN REMOVERS, ETC.

Products should be labeled "NONFLAMMABLE". Use according to MANUFACTURER'S DIRECTIONS in a well VENTILATED AREA or outdoors. Thoroughly RINSE ARTICLES by hand before placing them in the washer. Some of these products – rust removers, for example – will damage components and the finish of the washer.

FIRE HAZARD

13. KEEP AREA around and underneath washer free from the accumulation of combustible materials, such as lint, paper, rags, gasoline, and all other flammable vapors and liquids.

14. HYDROGEN GAS IS EXPLOSIVE and under certain conditions, hydrogen gas may be produced in a hot water system that has not been used for two weeks or more. If the hot water system has not been used for such a period, BEFORE USING THE WASHER, turn on all hot water faucets and let the water flow from each faucet for several minutes. This will release any accumulated hydrogen gas. As this gas is flammable, DO NOT SMOKE or use an open flame during this procedure.

15. Recent studies have shown that if vegetable oil contaminated materials are incompletely washed, a carry-over and buildup of the oil may contribute to a chemical reaction (spontaneous combustion) that could cause a load to catch fire by itself. This would be more likely to happen if the load was left in the dryer after tumbling stopped or if items were folded and stacked while warm.

SAVE THESE INSTRUCTIONS

PRINTED IN U.S.A.

Part No. 35-5840

**IMPORTANT
For Satisfaction Of Your Warranty –
Follow These Steps In Order**

If service or parts are ever necessary, contact the dealer from whom you purchased the appliance.

If your problem is not solved locally, please contact us by mail, or telephone during normal business hours and we will take the necessary steps to assure that parts or service are available to you within the terms of our warranty.

MAYTAG CUSTOMER SERVICE

P.O. Box 2370
Cleveland, Tennessee 37320-2370
Attn: Customer Relations Dept.
1-800-688-1120

Limited Transmission Warranty

Dual Drive Transmission

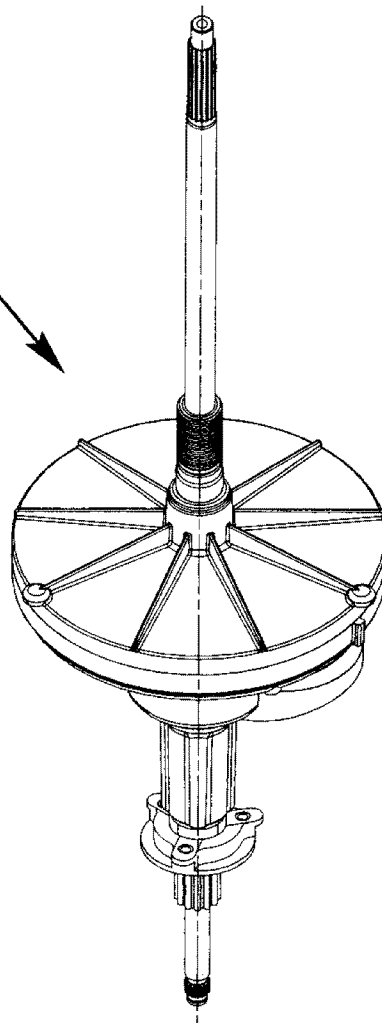
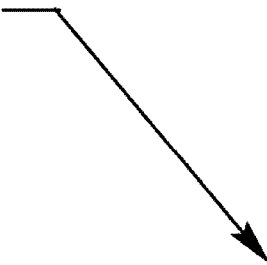

AUTOMATIC WASHER WARRANTY

FULL ONE YEAR WARRANTY

THE MANUFACTURER warrants this automatic washer, to consumer* only, against defects in material or workmanship for a period of one year from the date of its original purchase by a consumer for home use.

THE MANUFACTURER, will repair or replace, at its option, any automatic washer which evidences, within the warranty period, a defect in material or workmanship.

LIMITED WARRANTY Second Through Tenth Years

During the period beginning with the expiration of the full one year warranty and continuing through the tenth year after date of original purchase by a consumer, **THE MANUFACTURER**, will:

1. Replace or repair any transmission that has failed as a result of defective material or workmanship. See reverse side of this certificate for illustration of parts covered by this limited warranty.
2. Repair or replace any tub that has failed as a result of defective material or workmanship.

Owner will pay for mileage, and / or transportation, if required for service, and all labor costs.

LIMITED WARRANTY Second Through Twenty-Second Years

During the period beginning with the expiration of the full one year warranty and continuing through the twenty-second year after date of original purchase by a consumer, **THE MANUFACTURER**, will:

Repair or replace any tub that has failed as a result of defective material or workmanship.

Owner will pay for mileage, and / or transportation, if required for service, and all labor costs.

TERMS APPLICABLE TO ALL WARRANTIES

EXCLUSIONS

THE MANUFACTURER'S OBLIGATIONS UNDER THIS WARRANTY SHALL NOT EXTEND TO ANY MALFUNCTION OR OTHER PROBLEM CAUSED BY:

1. Unreasonable use, such as but not limited to:
 - (a) Improper setting of controls (see owner's guide).
 - (b) Improper installation including failure to conform to local electrical codes.
 - (c) Improper voltage supply, loose electrical connections or blown house fuses.
2. Circumstances not attributable to a defect in material or workmanship.
3. Parts not covered by the limited warranty, during the limited warranty period.
4. Unauthorized repair, alteration, modification or adjustment.

TO SECURE WARRANTY SERVICE

Contact your local dealer for referral to an authorized warranty servicer, or contact MAYTAG CUSTOMER SERVICE, P.O. Box 2370, Cleveland, TN 37230-2370. To save time, your letter should include the complete model and serial number of the warranted appliance, the name and address of the dealer from whom you purchased the appliance, the date of purchase and details concerning your problem.

LIMITATION OF LIABILITY

IN NO EVENT SHALL **THE MANUFACTURER** BE LIABLE FOR ANY INCIDENTAL OR CONSEQUENTIAL DAMAGES SUSTAINED BY ANY PERSON AS A RESULT OF ANY BREACH OF THIS WARRANTY OR ANY IMPLIED WARRANTY UNLESS HEREIN OTHERWISE PROVIDED. SOME STATES DO NOT ALLOW THE EXCLUSION OR LIMITATIONS OF INCIDENTAL OR CONSEQUENTIAL DAMAGES, SO THE ABOVE LIMITATIONS OR EXCLUSION MAY NOT APPLY TO YOU.

ADDITIONAL RIGHTS

This Warranty gives you specific legal rights, and you may also have other rights which may vary from state to state. No one is authorized to increase, alter, or enlarge **THE MANUFACTURER'S** responsibilities or obligations under these warranties.

* As defined in regulations under the Magnuson-Moss Warranty Act.