

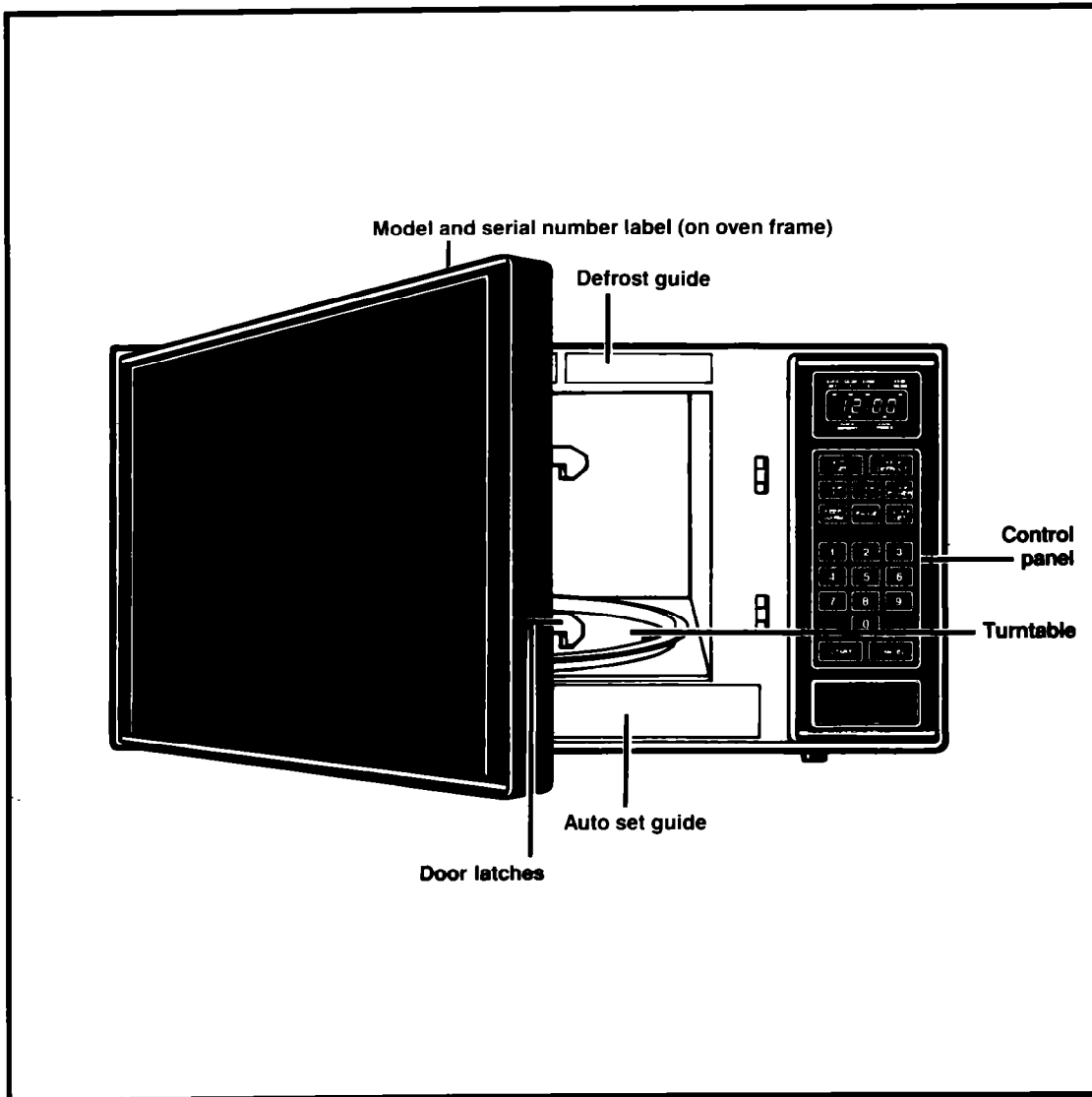

# Use & Care Guide



**MICROWAVE OVEN  
MT2150XW**

# Contents

	Page
<b>Important Safety Instructions</b> .....	3
<b>Precautions To Avoid Possible Exposure To Excessive Microwave Energy</b> .....	4
<b>Getting Acquainted</b> .....	5
Microwave oven features .....	5
Control panel features .....	6
Quick reference cooking guide .....	7
<b>Using Your Microwave Oven</b> .....	9
Microwave oven controls .....	9
Audible signals .....	10
Setting the clock .....	10
Cooking in your microwave oven .....	11
Cooking at high cook power .....	12
Cooking at lower cook powers .....	13
Using AUTO SET .....	14
Defrosting .....	16
Cooking automatically after defrosting .....	18
Cooking in more than one cook cycle .....	20
Using PAUSE .....	23
Using KEEP WARM .....	26
Using the Minute Timer .....	27
Using delayed start .....	28
Other operating hints .....	29
<b>Installation Instructions</b> .....	30
<b>Caring For Your Microwave Oven</b> .....	32
Cleaning the microwave oven .....	32
<b>How Your Microwave oven Works</b> .....	33
<b>Operating Safety Precautions</b> .....	34
Glass turntable .....	36
<b>If You Need Service Or Assistance</b> .....	38
<b>Whirlpool Microwave Oven Warranty</b> .....	40

© 1990 Whirlpool Corporation

**Thank you for buying a Whirlpool appliance. Please complete and mail the Owner Registration Card provided with this product. Then complete the form below. Have this information ready if you need service or call with a question.**

- Copy model and serial numbers from label (behind the microwave oven door on the frame) and purchase date from sales slip.
- Keep this book, the cooking guide and sales slip together in a handy place.

---

**Model Number**

---

**Serial Number**

---

**Purchase Date**

---

**Service Company Phone Number**

**Fill out and return the Microwave Registration Card included with your microwave oven. If the card is missing, please send the model and serial number of your microwave oven, with your name and address to . . .**

Whirlpool Corporation  
 Microwave Registration Department  
 Administrative Center  
 2000 M-63  
 Benton Harbor, Michigan 49022

This information will help us reach you if there is ever a need to pass along information about your microwave oven.

If your Microwave oven has a Consumer Buy Guide label, remove it. It will be easier to remove before the oven is used. To remove any remaining glue:

- Rub briskly with thumb to make a ball, then remove.
- or
- Soak area with liquid hand dishwashing detergent before removing glue as described above.

Do not use sharp instruments, rubbing alcohol, flammable fluids or abrasive cleaners. These can damage the finish. See "Important Safety Instructions" on page 3.

# Important Safety Instructions

Microwave ovens have been thoroughly tested for safe and efficient operation. However, as with any appliance, there are special installation and safety precautions which must be followed to ensure safe and satisfactory operation and prevent damage to the unit.

## **⚠ WARNING**

To reduce the risk of fire, electrical shock, injury to persons, or damage when using the microwave oven, follow basic precautions, including the following:

- Read all instructions before using the microwave oven.
- Read and follow the specific "Precautions To Avoid Possible Exposure To Excessive Microwave Energy" found on page 4.
- This appliance must be grounded. Connect only to properly grounded outlet. See Grounding Instructions found on page 31.
- Install or locate this appliance only in accordance with the provided Installation Instructions found on page 30.
- Some products such as whole eggs and sealed containers - for example, closed glass jars - may explode and should not be heated in this oven.
- Use this appliance only for its intended use as described in this manual.
- As with any appliance, close supervision is necessary when used by children.
- Do not operate this appliance if it has a damaged cord or plug, if it is not working properly, or if it has been damaged or dropped. Electrical shock, fire or other hazards may result.
- This appliance should be serviced only by qualified service personnel. Call an authorized Whirlpool<sup>SM</sup> service company for examination, repair or adjustment.
- Do not cover or block any opening on the appliance. Fire may result.
- Do not use outdoors. Damage to the oven or electrical shock may result.
- Do not immerse cord or plug in water. Electrical shock may result.
- Keep cord away from heated surfaces. Electrical shock may result.
- Do not let cord hang over edge of table or counter. Electrical shock may result.
- See door surface and interior cleaning instructions on page 32
- To reduce the risk of fire in the oven cavity:
  - Do not overcook food. Carefully attend appliance if paper, plastic, or other combustible materials are placed inside the oven to facilitate cooking. Paper can char or burn, and some plastics can melt if used when heating foods.
  - Do not deep fry in oven.
- **-Test dinnerware or cookware before using.** See page 37. Some dishes (melamine, Centura<sup>®</sup>, etc.) absorb microwave energy, becoming too hot to handle and slowing cooking times. Remove wire twist-ties from paper or plastic bags before placing bag in oven. Cooking in metal containers can damage the oven. So can containers with hidden metal (twist-ties, foil lining, staples, metallic glaze or trim.)
  - If materials inside the oven should ignite, keep oven door closed, turn oven off, and disconnect the power cord, or shut off power at the fuse or circuit breaker panel.
- Do not heat, store or use flammable materials in or near the oven. Fumes can create a fire hazard or explosion.
- Read and follow "Operating Safety Precautions" starting on page 34.

**-SAVE THESE INSTRUCTIONS-**

**You are responsible for:**

- Installing and leveling the oven on a surface strong enough to support its weight, and where it is protected from the elements.\* The microwave oven should be at a temperature above 50°F (10°C) for proper operation.
  - Properly connecting the oven to electrical supply and grounding it.\*
  - Operating the oven with the turntable in place.
  - Making sure the oven is not used by anyone unable to operate it properly.
  - Properly maintaining the oven.
  - Using the microwave oven only for jobs expected of a home microwave oven.
- \* See the Installation Instructions.

## Precautions To Avoid Possible Exposure To Excessive Microwave Energy...

**Do not** attempt to operate this oven with the door open since open-door operation can result in harmful exposure to microwave energy. It is important not to defeat or tamper with the safety interlocks.

**Do not** place any object between the oven front face and the door or allow soil or cleaner residue to accumulate on sealing surfaces.

**Do not** operate the oven if it is damaged. It is particularly important that the oven door close properly and that there is no damage to the:

- (1) Door (bent),
- (2) Hinges and latches (broken or loosened),
- (3) Door seals and sealing surfaces.

**Do not** operate the microwave oven if the door window is broken.

The microwave oven should be checked for microwave leakage by qualified service personnel after a repair is made.

The oven should not be adjusted or repaired by anyone except properly qualified service personnel.

**Do not** operate the microwave oven with the outer cabinet removed.

# Getting Acquainted

## Microwave oven features

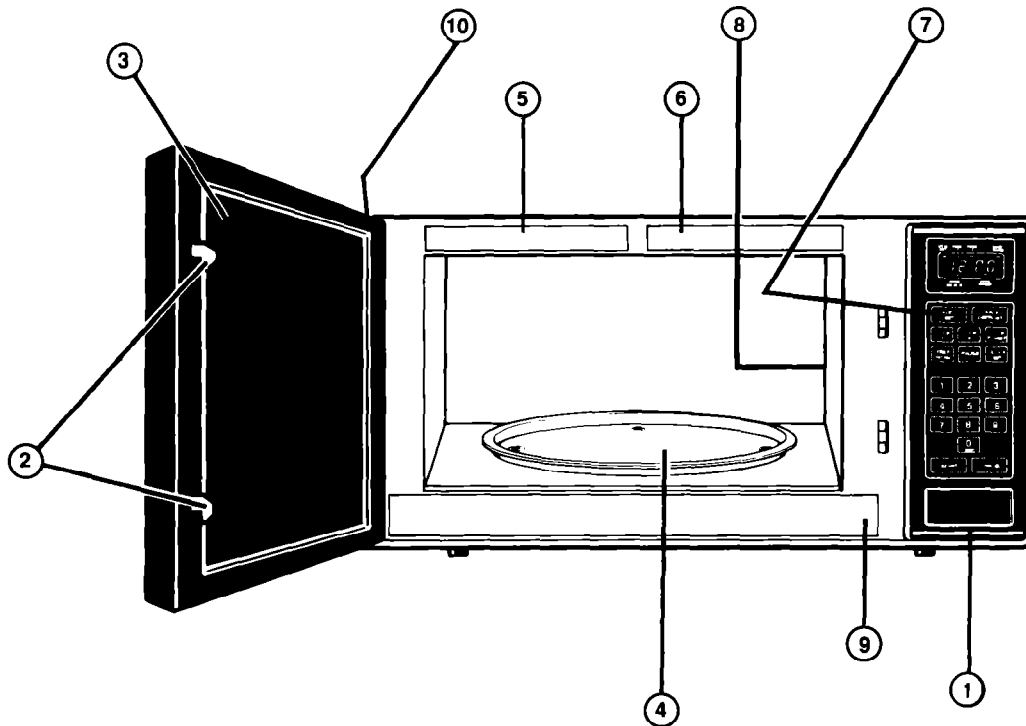

Your microwave oven is designed to make your cooking experience as enjoyable and productive as possible. To help get you up and running quickly, the following is a list of the oven's basic features:

- 1. Door Button.** Door must be pressed firmly shut for oven to operate.
- 2. Door Safety Lock System.**
- 3. Window with Metal Shield.** Shield prevents microwaves from escaping. It is designed as a screen to allow you to view food as it cooks.
- 4. Glass Turntable.** This turntable turns food as it cooks for more even cooking. It must be in oven during operation for best cooking results. See page 36 for more details.
- 5. Model and Serial Number Label.**
- 6. Defrost Guide.**
- 7. Control Panel.** Touch pads on this panel to perform all functions. See page 6 for more details.
- 8. Light.** Automatically turns on when oven is operating.
- 9. Auto Set Guide.**
- 10. External Oven Air Vents.**

## Control panel features

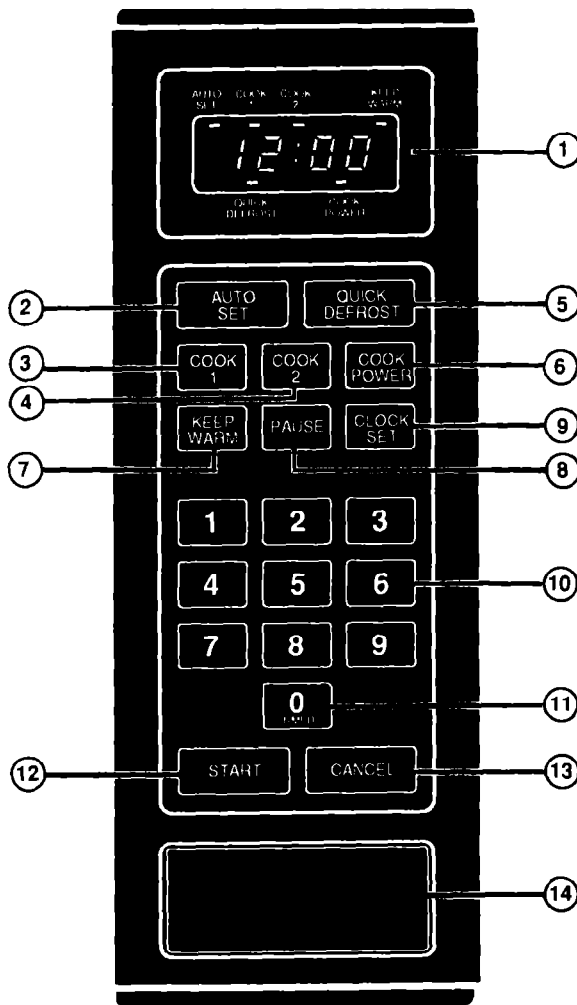

Your microwave oven control panel lets you select the desired cooking function quickly and easily. All you have to do is touch the necessary Command Pad. The following is a list of all the Command and Number Pads located on the control panel. For more information, see pages 9-29.

1. **Digital Display.** This display includes clock and indicator lights to tell you time of day, cooking time settings and cooking functions selected. See page 9 for more information.
2. **AUTO SET.** Touch this pad to select up to ten preset cooking times, at the Cook Powers of your choice. AUTO SET provides a short-cut method for setting commonly-used cooking times. See pages 14 -16 for more information.

3. **COOK 1.** Touch this pad when cooking at only one Cook Power or cooking automatically after defrosting. Touch COOK 1 to set the first Cook cycle when cooking at more than one Cook Power. This Command Pad is also the first pad touched when setting the Minute Timer or a delayed start time. See pages 12, 13, 18, 20, 27 and 28 for more information.
4. **COOK 2.** Touch this pad to set the second Cook cycle when cooking at more than one Cook Power. Also use this pad to change standing time and to set the Cook cycle after a delayed start time has been set with COOK 1. See pages 17, 20 and 28 for more information.
5. **QUICK DEFROST.** Touch this pad followed by Number Pads to thaw frozen food before cooking. See pages 16-17 for more information.
6. **COOK POWER.** Touch this pad followed by a Number Pad to set the amount of microwave energy released to cook the food. The higher the number, the higher the power or "heat". See page 13 for more information. See your MICRO MENUS® Cookbook for specific Cook Powers to use for the foods you are cooking.
7. **KEEP WARM.** Touch this pad to keep food warm for up to 99 minutes, 99 seconds. See page 26 for more information.
8. **PAUSE.** Touch this pad when you want the oven to pause between Cook cycles. Pausing between cycles gives you time to stir, turn over or rearrange the food, or to add ingredients. See pages 23-25 for more information.
9. **CLOCK SET.** Touch this pad followed by Number Pads to set time of day. See pages 10-11 for more information.
10. **Number Pads.** Touch a Number Pad after touching a Command Pad to tell the oven what time or Cook Power you wish to enter.
11. **"0" Number Pad.** Touch this Number Pad when setting the Minute Timer or Delayed Start. See pages 27-29 for more information.
12. **START.** Touch this pad after setting a function on the microwave oven to start the function.
13. **CANCEL.** Touch this pad once to stop the oven or to cancel a reminder tone. Touch it twice to remove the programming tone, reminder tone and Minute Timer signal completely. See page 10 for more information.
14. **DOOR OPEN BUTTON.**

## Quick reference cooking guide

Your microwave oven gives you a wide range of cooking capabilities. The following chart can be used as a quick reference when cooking. For more in-depth information, see the corresponding sections in this Use and Care Guide.

Type of cooking	How you use it	Why you use it
High power cooking	<ol style="list-style-type: none"> <li>1. Put food in the oven and close the door.</li> <li>2. Touch COOK 1.</li> <li>3. Touch Number Pads for the cooking time you want.</li> <li>4. Touch START.</li> </ol>	This mode is useful for quick cooking of small items and separate portions.
Lower power cooking (cook powers 1-9)	<ol style="list-style-type: none"> <li>1. Put food in the oven and close the door.</li> <li>2. Touch COOK 1.</li> <li>3. Touch Number Pads for the cooking time you want.</li> <li>4. Touch COOK POWER.</li> <li>5. Touch a Number Pad for the Cook Power you want.</li> <li>6. Touch START.</li> </ol>	This mode is necessary for efficient cooking of most foods. Failure to use the correct Cook Power may result in over- or under-cooking.
Auto Set	<ol style="list-style-type: none"> <li>1. Put food in the oven and close the door.</li> <li>2. Touch AUTO SET.</li> <li>3. Touch a Number Pad for the cooking time you want, from 1 to 9 minutes.</li> <li>4. Touch COOK POWER.</li> <li>5. Touch a Number Pad for the Cook Power you want.</li> <li>6. Touch START.</li> </ol>	This mode lets you select up to ten commonly-used cooking times by touching only one Number Pad for each time.
Defrosting	<ol style="list-style-type: none"> <li>1. Put food in the oven and close the door.</li> <li>2. Touch QUICK DEFROST.</li> <li>3. Touch Number Pads for the defrosting time you want.</li> <li>4. Touch START.</li> </ol>	This mode decreases the amount of time needed to thaw frozen food before cooking.
Two-cycle cooking	<ol style="list-style-type: none"> <li>1. Put food in the oven and close the door.</li> <li>2. Touch COOK 1.</li> <li>3. Touch Number Pads for the cooking time you want.</li> <li>4. Touch COOK POWER. (To use HIGH power, skip to Step 6.)</li> <li>5. Touch a Number Pad for the Cook Power you want in the first cycle.</li> <li>6. Touch COOK 2.</li> <li>7. Touch Number Pads for the cooking time you want in the second cycle.</li> <li>8. Touch COOK POWER. (If you want to use HIGH power, skip to Step 10.)</li> <li>9. Touch a Number Pad for the Cook Power you want in the second cycle.</li> <li>10. Touch START.</li> </ol>	This mode lets you cook at two different Cook Powers, one after another. Using this mode lets you fine-tune your cooking for better results.

continued on next page

**Getting Acquainted  
Continued**

Type of cooking	How you use it	Why you use it
<p><b>Pause</b></p>	<ol style="list-style-type: none"> <li>1. Put food in the oven and close the door.</li> <li>2. Touch in the desired cooking instruction for COOK 1.</li> <li>3. Touch PAUSE.</li> <li>4. Touch in the desired cooking instructions for COOK 2.</li> <li>5. Touch START.</li> </ol>	<p>This mode lets you set the oven to pause between cycles for stirring, turning over or rearranging food, as well as for adding ingredients.</p>
<p><b>Keep warm</b></p>	<ol style="list-style-type: none"> <li>1. Put cooked, hot food in the oven and close the door.</li> <li>2. Touch KEEP WARM.</li> <li>3. Touch START.</li> </ol>	<p>This mode lets you keep food warm in your microwave oven for about 1 hour, 40 minutes.</p>
<p><b>Delayed start</b></p>	<ol style="list-style-type: none"> <li>1. Put in food and close the door.</li> <li>2. Touch COOK 1.</li> <li>3. Touch Number Pads for the length of delay you want.</li> <li>4. Touch COOK POWER.</li> <li>5. Touch "0" Number Pad.</li> <li>6. Touch COOK 2.</li> <li>7. Touch in the cooking time and Cook Power.</li> <li>8. Touch START.</li> </ol>	<p>This mode lets you set the microwave oven to start automatically at a later time.</p>



# Using Your Microwave Oven

## Microwave oven controls

There are three parts in the control section:

- Digital Display/Clock and Indicator Lights
- Command Pads
- Number Pads

Instructions for each control are covered on the following pages. Read them carefully.

When you first plug in the oven, a tone will sound and the Display will show **88:88**. If after you set the Clock (pages 10-11), the Display again shows all 8's, it means your electricity was off for a while. Reset the Clock.

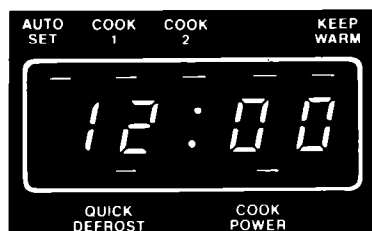

### Digital display/clock and indicator lights

When you are not using the microwave oven, this is an accurate digital clock.

When you are using the microwave oven, it displays time settings, temperature settings, and Indicator Lights.



### Command pads

Touch Command Pads to tell the microwave oven what to do and in what order. A few examples:

- CLOCK SET tells the oven you are going to set the clock.
- START tells the oven to start.

(See page 10 for information on the tone you hear when touching any pad.)

Each Command Pad (except START, CANCEL, and CLOCK SET) lights an Indicator Light when you touch the Command Pad.

While the oven is running, an Indicator Light (or lights) will be on to show what the oven is doing.

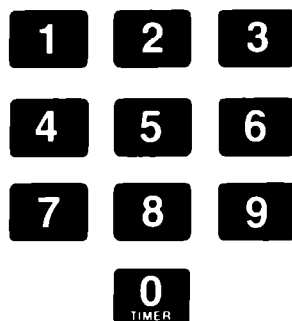

### Number pads

Once you've touched a Command Pad to tell the oven what you want it to do, you'll touch Number Pads to tell it...

- a time,
- a Cook Power.

## Audible signals

Audible signals are available to guide you when setting and using your oven. A programming tone will sound each time you touch a pad. Two beeps will sound between cycles. A reminder tone will sound every 30 seconds after cooking is done to remind you that something has been left in the oven. Four beeps signal the end of the Minute Timer function and a Cook or Defrost cycle. If you don't hear a tone, it is because of incorrectly entered instructions or because the tones have been removed. For example, a tone will not sound if you touch a Number Pad before you touch a Command Pad.

### To remove the programming tone:

1. Open the door.
2. Touch CANCEL **twice**, then touch START.
3. Programming tones will be cancelled.

### To replace the tones:

- Repeat the steps above.

### To remove all tones:

1. Open the door.
2. Touch CANCEL **twice**, touch 0, then touch START.
3. All audible tones (including Minute Timer signal) will be cancelled.

**NOTE:** Do not remove all tones if you use the Minute Timer.

### To replace the tones:

- Repeat the steps above.

**NOTE:** If your electricity goes off, the audible signals will come back on. Repeat steps above if you want to remove them again.

## Setting the clock

When the oven is first plugged in, a tone sounds and the Display shows **88:88**. If the electric power ever goes off, the Display will again show all 8's when the power comes back on.

You can cook without setting the clock, but the Display will be blank after cooking.

1. Touch CLOCK SET. The Display will show a "0" and the colon will start to flash. **The first Number Pad must be touched within 5 seconds or the Display will go blank.** If the Display goes blank, touch CLOCK SET again and continue.

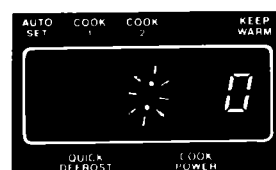
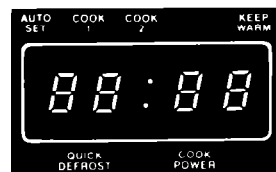

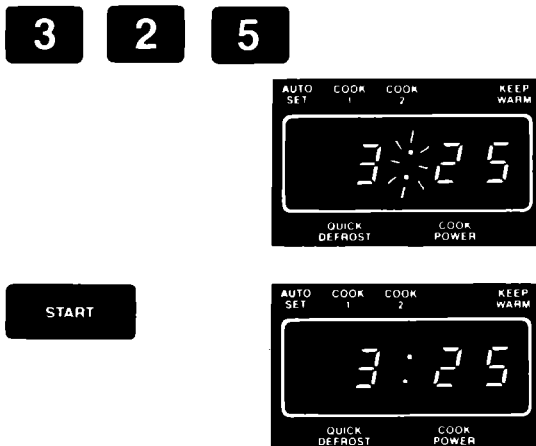

2. Touch Number Pads for the correct time of day. The Display will show what numbers you touched **in the order you touched them**. This example shows 3:25.

3. Touch START. The colon will stop flashing. The Clock is set.

If you have touched in an incorrect time, such as 12:65, "Err" will show on the Display. Touch CLOCK SET and start over.

**NOTE:** To reset the clock, touch CLOCK SET. The current time will show on the Display and the colon will flash. Continue to set the clock as shown above.

## Cooking in your microwave oven

Be sure to read the MICRO MENUS® Cookbook packed with the microwave oven. It contains information about:

- What microwave energy is.
- How food is cooked by microwave energy.
- What affects cooking speed and cooking evenness.
- Safety tips.
- Utensils to use when cooking in a microwave oven.
- Cooking times for different foods.

### Important things to remember to get the best cooking results.

- ALWAYS cook food for the minimum recommended cooking time. If necessary, add time in one or two minute periods, then check for doneness to avoid overcooking the food.
- Stir, turn over or rearrange the food being cooked about halfway through the cooking time for most even doneness with all recipes.
- If a glass cover is not available, use waxpaper, paper towels or microwave approved plastic wrap. Turn back a corner to vent steam during cooking.
- ALWAYS cook food with turntable in place.

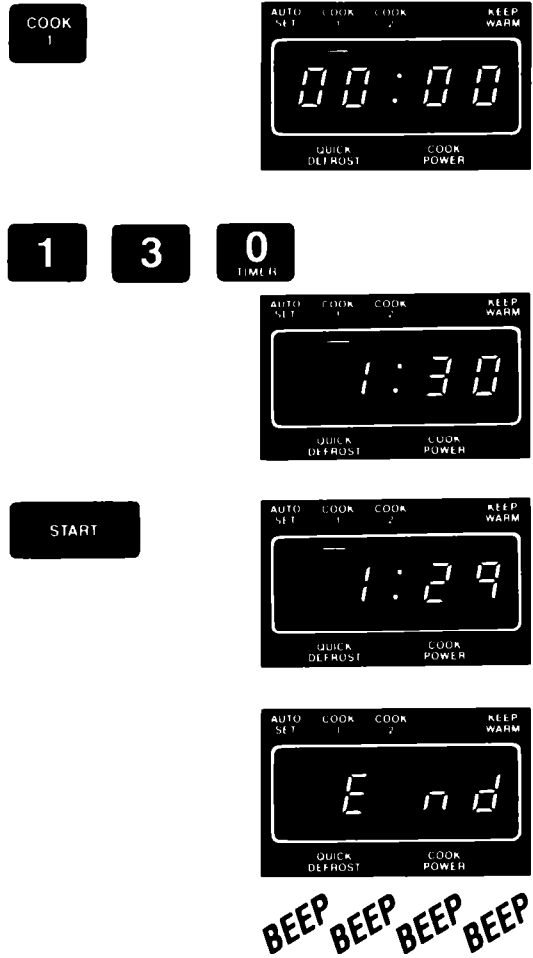

## Cooking at high cook power

Follow these steps to cook at **HIGH power**:

1. Put food in the oven and close the door.
2. Touch COOK 1. The COOK 1 Indicator Light will come on and the Display will show four 0's.
3. Touch Number Pads for the cooking time you want. The Display will show the numbers you touched **in the order you touched them**. The example shows 1 minute, 30 seconds.
4. Touch START. The oven will automatically cook at HIGH Cook Power.  
The COOK 1 Indicator Light will stay on to show that the oven is cooking in the first cycle.  
The Display counts down the time to show how much time is left in the first cycle.

When the cooking time ends, "End" will show on the Display and 4 beeps will sound. (You can stop the beeping by opening the door or by touching CANCEL.) "End" will remain on the Display and a reminder tone will sound every 30 seconds (to remind you that food is left in the oven) until the door is opened or CANCEL is touched. The Display will then show the time of day.

## Changing the cooking time

Cooking time can be changed any time before or after touching START:

1. Touch COOK 1.
2. Touch numbers for the new time.
3. Touch START.  
Cook 1 cycle will continue cooking for the new time.

## Cooking at lower cook powers

For best results, some recipes call for lower Cook Powers. The lower the Cook Power, the slower the cooking. Each Number Pad also stands for a different percentage of Cook Power. Many recipes in your MICRO MENUS® Cookbook tell you, by number, which Cook Power to use. Recipes in other books and magazines may tell you by name (HI, MED, LO, etc.) or percentage (10%, 50%, 80%, etc.).

The following chart gives the percentage of Cook Power each Number Pad stands for, and Cook Power name usually used:

- automatic 100% of full power HIGH
- 9 = 90% of full power
- 8 = 80% of full power
- 7 = 70% of full power MED-HIGH
- 6 = 60% of full power
- 5 = 50% of full power MED
- 4 = 40% of full power
- 3 = 30% of full power MED-LOW
- 2 = 20% of full power
- 1 = 10% of full power LOW
- 0 = TIMER (fan and light will be off)

1. Put food in the oven and close the door.
2. Touch COOK 1. The COOK 1 Indicator Light will come on and the Display will show four 0's.

COOK  
1



7

3

0  
TIMER

3. Touch Number Pads for the cooking time you want. The Display will show the numbers you touched **in the order you touched them**. This example shows 7 minutes, 30 seconds.

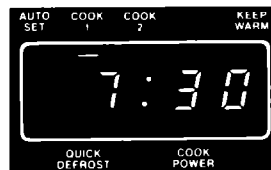

COOK  
POWER

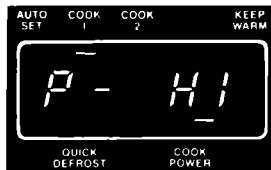

4. Touch COOK POWER. The COOK POWER Indicator Light will come on and the Display will show "P-HI". This shows the oven is pre-programmed to cook at full (HIGH) power.

5



5. Touch a Number Pad for the Cook Power you want. The Display will show what you touched. This example shows you touched Number Pad 5 for 50% of full power.

## Using Your Microwave Oven Continued

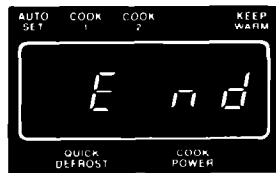
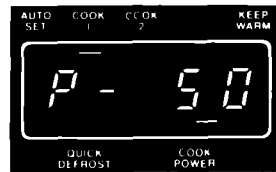

**BEEP BEEP BEEP BEEP**

6. Touch START. The COOK 1 and COOK POWER Indicator Lights will stay on to show that the oven is cooking in the first cycle at a Cook Power other than HIGH. The Display counts down the time to show how much cooking time is left in the first cycle.

For 2 of every 10 seconds, the Display will show the Cook Power you selected.

When the cooking time ends, "End" will show on the Display and 4 beeps will sound. (You can stop the beeping by opening the door or by touching CANCEL.) "End" will remain on the Display and a reminder tone will sound every 30 seconds (to remind you that food is left in the oven) until the door is opened or CANCEL is touched. The Display will then show the time of day.

### Changing the cook power

The **Cook Power** can be changed any time before or after touching START:

1. Touch COOK POWER.
  2. Touch a Number Pad for the new Cook Power.
  3. Touch START. The cycle will cook at the new Cook Power for the original time.
- OR..**
1. Touch COOK POWER **twice** if you want to change a lower Cook Power to HIGH.
  2. Touch START.

### Using AUTO SET

Auto Set provides ten preset times. One to nine minutes at HIGH Cook Power can be selected by touching AUTO SET and the corresponding Number Pad (1-9). You don't need to touch any additional Number Pads as you do when using COOK 1 or COOK 2. This provides a short-cut method for setting commonly used cooking times.

The AUTO SET chart included with your microwave oven and the AUTO SET guide on the inner door panel helps you cook various food items without having to look up the cooking times.

A preset time of 2 minutes, 30 seconds at HIGH Cook Power is available by touching just the AUTO SET pad. The time may be changed to any time from 0-99 minutes, 0-99 seconds, allowing you to store your favorite cooking time and Cook Power, or to preprogram the oven for someone else to cook an already prepared dish at a later time. See page 16 for instructions.

AUTO SET

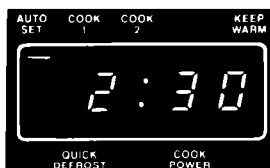

4

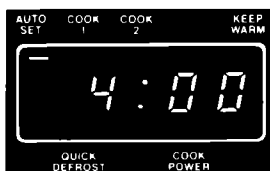

COOK POWER



5



START

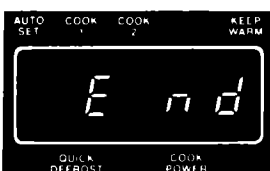
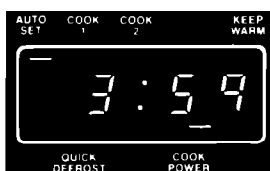

BEEP BEEP BEEP BEEP

1. Put food in the oven and close the door.
2. Touch AUTO SET. (Option: Skip to Step 6 if you want to use the preset cooking time and Cook Power.) The AUTO SET Indicator Light will come on and the Display will show 2 minutes, 30 seconds (or the time you have set as your favorite cycle).
3. Touch a Number Pad for the new cooking time you want from 1 to 9 minutes. The Display will show what you touched in even minutes. This example shows 4 minutes.

4. Select a Cook Power. To cook at HIGH power, skip to Step 6. To select another Cook Power, touch COOK POWER. The COOK POWER Indicator Light will come on and the Display will show "P-HI". This shows the oven is preprogrammed to cook at full (HIGH) power.

5. Touch a Number Pad for the Cook Power you want. The Display will show what you touched. This example shows you touched Number Pad 5 for 50% of full power.

6. Touch START. The AUTO SET Indicator Light will stay on while the oven is cooking in the preprogrammed cycle. If you selected a Cook Power other than HIGH, the Cook Power Indicator Light will also come on.

The Display counts down the time to show how much cooking time is left.

For 2 of every 10 seconds, the Display will show the Cook Power you selected, if you are using a Cook Power other than HIGH.

When the Auto Set ends, "End" will show on the Display and 4 beeps will sound. (You can stop the beeping by opening the door or by touching CANCEL.) "End" will remain on the Display and a reminder tone will sound every 30 seconds (to remind you that food is left in the oven) until the door is opened or CANCEL is touched. The Display will then show the time of day.

**NOTE:** You can set COOK 1 or COOK 1 and 2 to follow Auto Set, (see pages 20-22 for instructions).

## Using Your Microwave Oven Continued

### Changing the preprogrammed setting

You can change the preprogrammed cooking time and Cook Power in AUTO SET to the time and power you most often use. To change the AUTO SET setting, follow these steps:

1. Touch AUTO SET twice.
2. Touch the Number Pads for the new desired cooking time. If HIGH Cook Power is desired, skip to Step 5.
3. Touch COOK POWER.
4. Touch the Number Pad for the desired Cook Power.
5. Touch AUTO SET. Touch CANCEL. The oven will remember that time and Cook Power for future use.

**NOTE:** If electric power ever goes off, the oven will go back to the preprogrammed 2 minutes, 30 seconds at HIGH Cook Power setting.

### Defrosting

Use QUICK DEFROST to thaw frozen food before cooking. For suggested defrost times, see the guide behind the oven door or the chart in your MICRO MENUS® Cookbook.

1. Put frozen food in the oven and close the door.
2. Touch QUICK DEFROST. The QUICK DEFROST Indicator Light will come on and the Display will show four 0's.

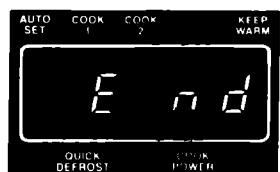
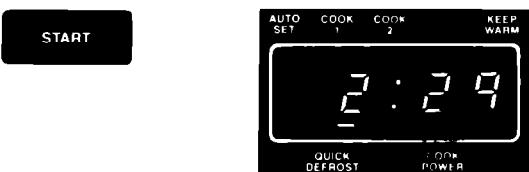
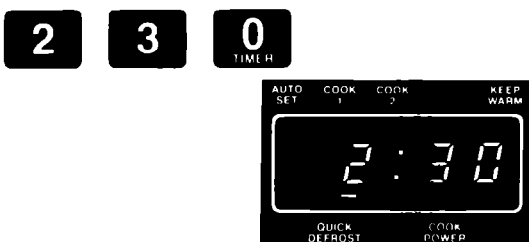

**BEEP BEEP BEEP BEEP**

3. Touch Number Pads for the defrosting time you want. The Display will show the numbers you touched **in the order you touched them**. This example shows 2 minutes, 30 seconds.

4. Touch START. The QUICK DEFROST Indicator Light will stay on to show that the oven is in the Quick Defrost cycle. The Display counts down the time to show how much defrosting time is left.

When the defrost time ends, "End" will show on the Display and 4 beeps will sound. (You can stop the beeping by opening the door or by touching CANCEL.) "End" will remain on the Display and a reminder tone will sound every 30 seconds (to remind you that food is left in the oven) until the door is opened or CANCEL is touched. The Display will then show the time of day.



**Using PAUSE with QUICK DEFROST**

If the defrosting instructions call for stirring or turning over the food in the middle of the defrost cycle, program PAUSE after QUICK DEFROST. See pages 24-25 for more information.

**Standing time after defrosting**

For best results, allow the food to stand for a while after defrosting. This helps equalize the temperature of the food to provide more even defrosting.

When COOK 1 follows QUICK DEFROST, the oven automatically provides a standing time equal to the time touched in for QUICK DEFROST. COOK 1 will begin after the automatic standing time. See "Cooking automatically after defrosting," page 18.

**For a different standing time:**

1. Touch QUICK DEFROST and the desired time.
2. Touch COOK 2.
3. Touch Number Pads for the desired standing time.
4. Touch COOK POWER.
5. Touch "0" for zero Cook Power.
6. Touch START.

When QUICK DEFROST is over, the oven will shut off. Two beeps will sound. The Display will count down the new standing time programmed.

**About the Quick Defrost cycle**

The microwave oven automatically divides the time set for the Quick Defrost cycle into three equal parts:

- First part.....80% of full Cook Power
- Second part.....50% of full Cook Power
- Third part.....20% of full Cook Power

This automatic step-down in Cook Power helps defrost food quickly and completely.

**Changing or adding defrost time**

You can change the defrosting time any time before or after touching START.

1. Touch QUICK DEFROST.
2. Touch Number Pads for new time.
3. Touch START.

**Any new time setting made while Quick Defrost is operating will continue the defrosting at only 20% of full power.**

The best time to change the setting is near the end of the Quick Defrost cycle.

1. Open the door.
2. Check the food with a long-tined fork; if center area is hard frozen, set additional time. **Remember that standing time is necessary to complete defrosting.**
3. Close the door and touch START to continue the cycle if no additional time is needed.  
**OR...**  
 Touch in new instructions for additional defrosting time.

## Cooking automatically after defrosting

The controls can be set so the microwave oven goes automatically from defrosting to the Cook cycle you have touched in.

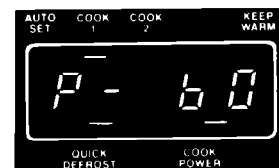
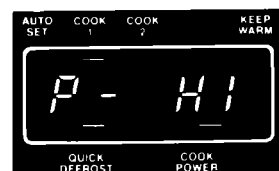
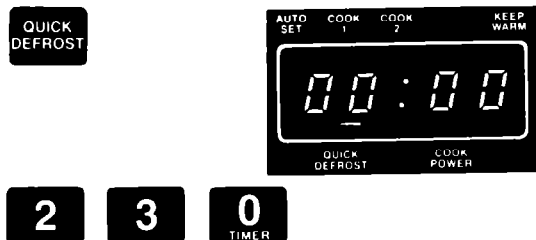

1. Put food in the oven and close the door.
2. Touch QUICK DEFROST. The QUICK DEFROST Indicator Light will come on and the Display will show four 0's.
3. Touch Number Pads for the defrosting time you want. The Display will show the numbers you touched **in the order you touched them**. This example shows 2 minutes, 30 seconds.
4. Touch COOK 1. The COOK 1 Indicator Light will come on and the Display will show four 0's.
5. Touch Number Pads for the cooking time you want. The Display will show the numbers you touched **in the order you touched them**. This example shows 4 minutes, 30 seconds.
6. Select a Cook Power. To cook at HIGH power, skip to Step 8. To select another Cook Power, touch COOK POWER. The COOK POWER Indicator Light will come on and the Display will show "P-HI". This shows the oven is preprogrammed to cook at full (HIGH) power.
7. Touch a Number Pad for the Cook Power you want. The Display will show what you touched. This example shows you touched Number Pad 6 for 60% of full power.

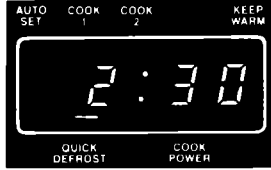
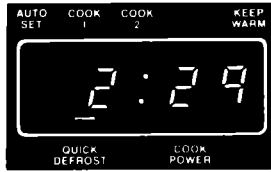

**BEEP BEEP**

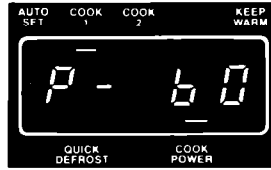
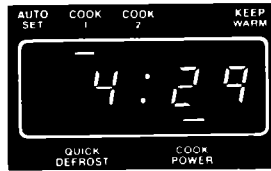

**BEEP BEEP BEEP BEEP**

8. Touch START. When you touch START, the QUICK DEFROST Indicator Light will stay on. All other Indicator Lights will go off. The Display counts down the time to show how much time is left in the Quick Defrost cycle.

When the defrost time ends, the microwave oven automatically lets the food stand for the **same amount of time used for defrosting**. The QUICK DEFROST Indicator Light stays on and the Display counts down the standing time. **During the countdown the oven will be dark, and the fan will be off.**

When the standing time is over, you will hear 2 beeps and the Cook cycle will start.

The COOK 1 Indicator Light will be on during the Cook cycle. The COOK POWER Indicator Light will also be on **if you are using a Cook Power other than HIGH.**

The Display counts down the time to show how much time is left in the second cycle.

For 2 of every 10 seconds, the Display will show the Cook Power you selected, if you are using a Cook Power other than HIGH.

When the Cook cycle ends, "End" will show on the Display and 4 beeps will sound. (You can stop the beeping by opening the door or by touching CANCEL.) "End" will remain on the Display and a reminder tone will sound every 30 seconds (to remind you that food is left in the oven) until the door is opened or CANCEL is touched. The Display will then show the time of day.

## Cooking in more than one cook cycle

For best results, some recipes call for one Cook Power for a certain length of time, and another Cook Power for another length of time. Your oven can be set to change from one to another automatically.

1. Put food in the oven and close the door.
2. Touch COOK 1. The COOK 1 Indicator Light will come on and the Display will show four 0's.

COOK 1



3

2

5

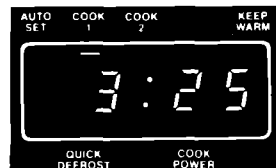

3. Touch Number Pads for the cooking time you want in the first cycle. The Display will show the numbers you touched **in the order you touched them**. This example shows 3 minutes, 25 seconds.

COOK POWER

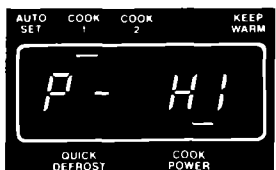

4. Select a Cook Power. To cook at HIGH power, skip to Step 6. To select another Cook Power, touch COOK POWER. The COOK POWER Indicator Light will come on and the Display will show "P-HI". This shows the oven is preprogrammed to cook at full (HIGH) power.

6

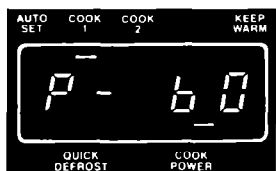

5. Touch a Number Pad for the Cook Power you want in the first cycle. The Display will show what you touched. This example shows you touched Number Pad 6 for 60% of full power.

COOK 2



6. Touch COOK 2. The COOK 2 Indicator Light will come on and the Display will show four 0's.

4

3

0  
TIMER

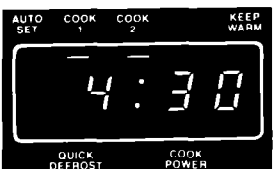

7. Touch Number Pads for the cooking time you want in the second cycle. The Display will show the numbers you touched **in the order you touched them**. This example shows 4 minutes, 30 seconds.

COOK POWER

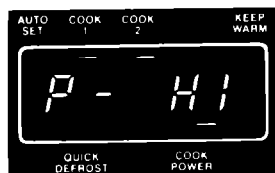

4

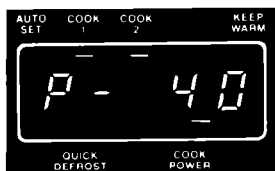

START



BEEP BEEP



BEEP BEEP BEEP BEEP



8. Select a Cook Power. To cook at HIGH power, skip to Step 10. To select another Cook Power, touch COOK POWER. The COOK POWER Indicator Light will come on and the Display will show "P-HI". This shows the oven is preprogrammed to cook at full (HIGH) power.

9. Touch a Number Pad for the Cook Power you want in the second cycle. The Display will show what you touched. This example shows you touched Number Pad 4 for 40% of full power.

10. Touch START. When you touch START, the COOK 1 Indicator Light will stay on while the oven is cooking in the first cycle. The COOK POWER Indicator Light will be on if you are using a Cook Power other than HIGH. All other Indicator Lights will go off.

The Display counts down the cooking time to show how much time is left in the first cycle.

For 2 of every 10 seconds, the Display will show the Cook Power you selected, if you are using a Cook Power other than HIGH.

You will hear 2 beeps at the end of the Cook 1 cycle. You can either open the door to check, stir or turn over the food, etc., or you can let the oven start the next cycle. If you do open the door, touch START after closing the door to restart the oven.

The COOK 2 Indicator Light will be on during the second cycle. The COOK POWER Indicator Light will also be on if you are using a Cook Power other than HIGH.

The Display counts down the time to show how much time is left in the second cycle.

For 2 of every 10 seconds, the Display will show the Cook Power you selected, if you are using a Cook Power other than HIGH.

When the Cook 2 cycle ends, "End" will show on the Display and 4 beeps will sound. (You can stop the beeping by opening the door or by touching CANCEL.) "End" will remain on the Display and a reminder tone will sound every 30 seconds (to remind you that food is left in the oven) until the door is opened or CANCEL is touched. The Display will then show the time of day.

## Using Your Microwave Oven Continued

### Hints for cooking with more than one cycle

You can program the cooking cycles in any order. However, when the microwave oven is started, it will automatically go through the cycles in the order of the examples described in this book. For example, if you program COOK 1, KEEP WARM and QUICK DEFROST, the microwave oven will automatically follow this sequence: QUICK DEFROST → (STANDING TIME) → COOK 1 → KEEP WARM.

**NOTE:** The microwave oven will automatically provide standing time between QUICK DEFROST and COOK 1. (See page 17.)

### Changing or adding instructions

You can change times, Cook Powers, or add cycles any time before touching START or during oven operation:

1. Touch the Cook cycle you wish to change or add (COOK 1 or 2).
2. Touch numbers for new time, if desired.
3. Touch COOK POWER, if change is desired.
4. Touch number for new Cook Power, or touch COOK POWER again if HIGH is desired.
5. Touch in new cycle and time, if desired.
6. Touch START.

## Using PAUSE

For best results, some recipes call for stirring, turning over or rearranging food, or for adding ingredients during cooking. Your microwave oven can be set to pause between COOK 1 and COOK 2, between AUTO SET and a following cycle, between QUICK DEFROST and a following cycle (except COOK 1), or during QUICK DEFROST.

This gives you time to stir (casseroles), turn over (meat) or rearrange (potatoes) food, or to add ingredients. PAUSE is not available between any cycle and KEEP WARM or after QUICK DEFROST.

1. Put food in the oven and close the oven door.
2. Touch in the desired cooking instructions for COOK 1, (page 20).
3. Touch PAUSE. The COOK 1 Indicator Light will be on and the Display will show "PAUS".
4. Touch in the desired cooking instructions for COOK 2, (see page 20).



**BEEP BEEP**



5. Touch START. The Display will show the time you selected for Cook 1.

When Cook 1 is over, 2 beeps will sound and the oven will shut off. The Display will show "PAUS".

The COOK 2 Indicator Light will come on. Open the door, stir, turn over or rearrange the food or add ingredients. Close the door. Touch START to continue with Cook 2.

**NOTE:** The oven will remain off until you touch START.

## Using Your Microwave Oven Continued

QUICK  
DEFROST



2

3

0  
TIMER

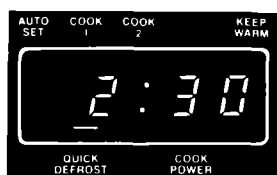

PAUSE



START

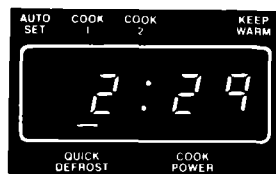

**BEEP  
BEEP**

### Using PAUSE with QUICK DEFROST

Your microwave oven can be set to pause halfway through QUICK DEFROST to allow you to stir, turn over or rearrange the food for more even defrosting.

1. Put frozen food in the oven and close the door.
2. Touch QUICK DEFROST.

3. Touch Number Pads for the defrosting time you want.

4. Touch PAUSE.

5. Touch START.

When half of the QUICK DEFROST time is remaining, you will hear 2 beeps and the oven will shut off.



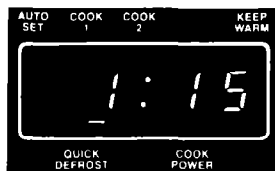
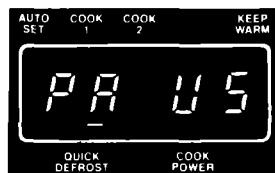

**BEEP BEEP BEEP BEEP**

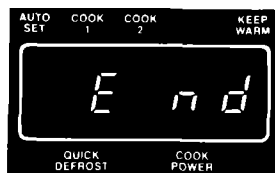

6. Open the door. You can stir, turn over or rearrange the food being defrosted, if needed. Close the door.

7. Touch START to continue QUICK DEFROST.

**NOTE:** The oven will remain off until you touch START.

When the defrost time ends, "End" will show on the Display and 4 beeps will sound. (You can stop the beeping by opening the door or by touching CANCEL.) "End" will remain on the Display and a reminder tone will sound every 30 seconds (to remind you that food is left in the oven) until the door is opened or CANCEL is touched. The Display will then show the time of day.

#### Adding "PAUSE" between cycles

Pause can be added to any cycle in operation as long as there is another cycle programmed to follow.

1. Touch PAUSE.
2. Touch START.

The microwave oven will stop automatically after the cycle in operation. You will hear 2 beeps. START must be touched to continue with the next cycle.

KEEP  
WARM



START



## Using KEEP WARM

Hot, cooked foods can be safely kept warm in your microwave oven for up to 99 minutes, 99 seconds (about 1 hour, 40 minutes). KEEP WARM can be used by itself, or it can automatically follow a Cook cycle.

1. Put cooked, hot food in oven and close door.
2. Touch KEEP WARM. The KEEP WARM Indicator Light will come on. The Display will show the time of day.

3. Touch START. The KEEP WARM Indicator Light will stay on. The oven light and the fan will come on. The Display will continue to show the time of day.
- KEEP WARM operates for up to 99 minutes, 99 seconds.
  - Opening the oven door cancels KEEP WARM. Close the door and touch KEEP WARM, then START if additional KEEP WARM time is desired.
  - Foods cooked covered should be covered during KEEP WARM.
  - Pastry items (pies, turnovers, etc.) should be uncovered during KEEP WARM.
  - Complete meals kept warm on a dinner plate should be covered during KEEP WARM.
  - The use of more than one complete KEEP WARM (about 1 hour, 40 minutes) is not recommended. The quality of some foods will suffer with extended time.

### To automatically follow another cycle

- While you are touching in cooking instructions, touch KEEP WARM before touching START.
- OR...**
1. After the oven starts operating, touch KEEP WARM and then START.
  2. When the last cooking cycle is over, you will hear 4 beeps. The KEEP WARM Indicator Light will come on and the time of day will be displayed while the oven continues to run.
  3. KEEP WARM will follow QUICK DEFROST, COOK 1, COOK 2 or AUTO SET.

## Using the Minute Timer

The microwave oven controls can be used as a minute timer. Use COOK 1 at "0" Cook Power for timing up to 99 minutes, 99 seconds.

**NOTE:** The oven will not operate while the Minute Timer is in use.

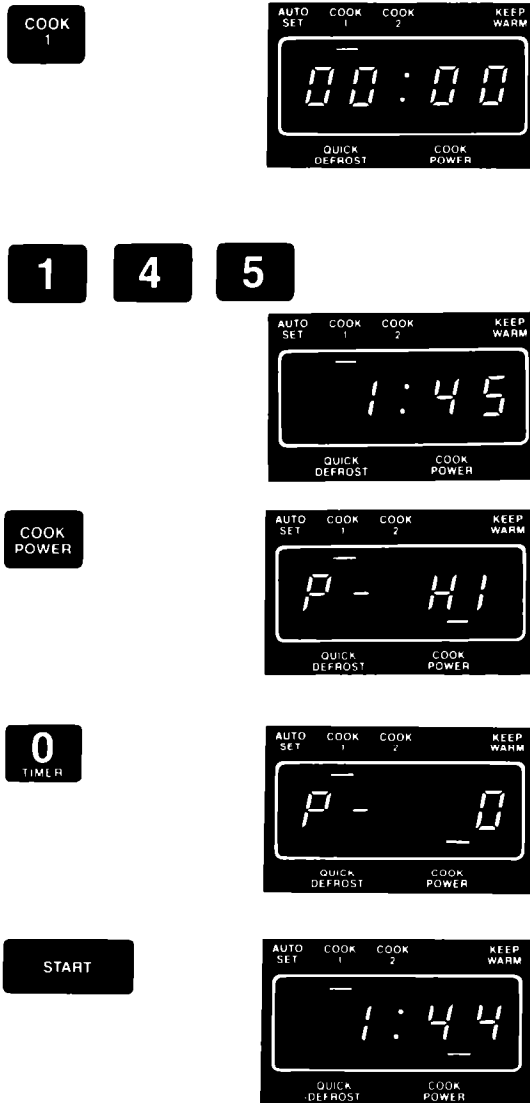

1. Touch COOK 1. The COOK 1 Indicator Light will come on and the Display will show four 0's.

2. Touch Number Pads for the minutes and seconds you want. The Display will show the numbers you touched **in the order you touched them**. This example shows 1 minute, 45 seconds.

3. Touch COOK POWER. The COOK POWER Indicator Light will come on and the Display will show "P-HI".

4. Touch the "0" Number Pad. The Display will show "P-0". This tells you that the oven will be operating at 0% power.

5. Touch START.

**NOTE:** If you hear the fan start when you touch START, you have not set the oven properly. Touch CANCEL and start over.

The COOK 1 and COOK POWER Indicator Lights will stay on to show you that the timer is running.

The Display counts down to show you how much time is left. During the countdown the oven will be dark and the fan will be off.

## Using Your Microwave Oven Continued

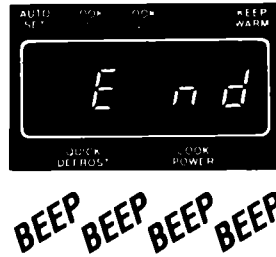

When the set time ends, "End" will show on the Display and 4 beeps will sound. (You can stop the beeping by opening the door or by touching CANCEL.) "End" will remain on the Display and a reminder tone will sound every 30 seconds (to remind you that the Minute Timer has ended) until the door is opened or CANCEL is touched. The Display will then show the time of day.

**NOTE:** Opening the oven door stops the countdown. Close the door and touch START to continue the timing countdown.

## Using delayed start

The microwave oven can be set to start automatically at a later time. Use the Cook 1 cycle at "0" Cook Power to delay the start of the Cook 2 cycle for up to 99 minutes, 99 seconds.

1. Put in food and close the door. (See WARNING on page 29.)
2. Touch COOK 1. The COOK 1 Indicator Light will come on and the Display will show four "0"s.
3. Touch Number Pads for the length of delay you want. The Display will show the numbers you touched **in the order you touched them**. This example shows 60 minutes (1 hour).
4. Touch COOK POWER. The COOK POWER Indicator Light will come on and the Display will show "P-HI".
5. Touch the "0" Number Pad. The Display will show "P-0". This tells you that the oven will be operating at 0% power.
6. Touch COOK 2. The COOK 2 Indicator Light will come on and the Display will show four "0"s.
7. Touch in the cooking time and Cook Power.

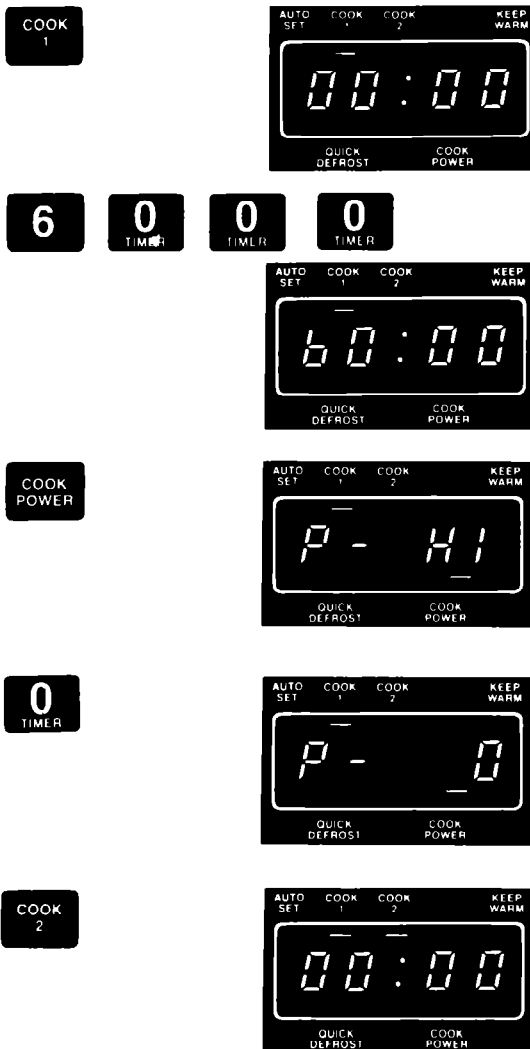



8. Touch START. During the Cook 1 cycle the oven will be off, but the Display will count down the set time. After this time is up, the Cook 2 cycle will begin.

**NOTE:** If you hear the fan start when you touch START, you have not set the oven properly. Touch the CANCEL Pad and start over. When using Delayed Start, the oven cooks only during the Cook 2 cycle.

#### Additional information

- You can't touch in more than 99 minutes, 99 seconds of delay in the Cook 1 cycle.
- If you open the door before the oven begins to cook, be sure to retouch START.

### ⚠ WARNING

To avoid sickness and food waste when using delay start:

- Do not use foods that will spoil while waiting for cooking to start, such as dishes with milk or eggs, cream soups, and cooked meats or fish. Any food that has to wait for cooking to start should be very cold or frozen before it is put in the oven. **MOST UNFROZEN FOODS SHOULD NEVER STAND MORE THAN TWO HOURS BEFORE COOKING STARTS.**
- Do not use foods containing baking powder or yeast when using delay start. They will not rise properly.
- Do not allow food to remain in oven for more than two hours after end of cooking cycle.

### Other operating hints

There are a number of things you can do with your microwave oven. Some will be reminders. Others will be mentioned for the first time.

#### To double check settings while the oven is running:

Touch the Command Pad for the setting you want to check. The instruction programmed for that pad will show on the Display for 5 seconds. Then the Display returns to showing what the oven is doing.

#### To stop the oven while it is running:

1. Open the door. The oven will stop. To restart the oven, close the door and touch START.
2. Touch CANCEL. All instructions will be erased. You must touch in new instructions.
3. If you touch two instructions into the same cycle, the second set of instructions will cancel the first.

# Installation Instructions

Before you begin, carefully read the following instructions.

## Installing your microwave oven

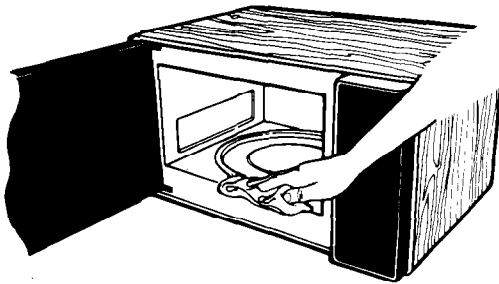

1. Empty the microwave oven and clean inside it with a soft, damp cloth. Check for damage such as misaligned door, damage around the door or dents inside the oven or on the exterior. If there is any damage, please do not operate the unit until it has been checked by an authorized Whirlpool<sup>SM</sup> service technician and any repairs made.

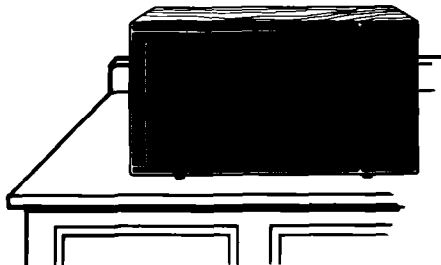

2. Put the oven on a cart, counter, table or shelf that is strong enough to hold the oven and the food and utensils you put in it. **(The control side of the unit is the heavy side. Use care when handling.)** The weight of the oven is approximately 33 lbs. (15 kg).

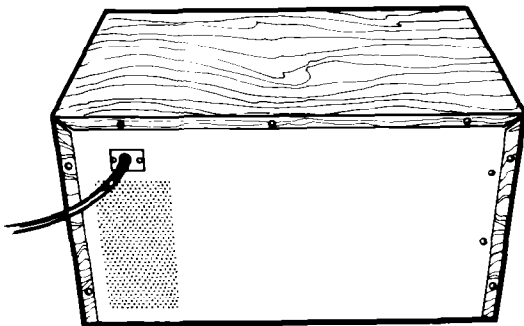

3. **Do not block the rear air intake opening.** Blocking the air intake opening can cause damage to the oven and poor cooking results. Make sure the microwave oven legs are in place to ensure proper air flow.

### **⚠ CAUTION**

**Do not install the oven next to a conventional surface unit or in any area where excessive heat and steam are generated. This could damage the outside of the cabinet.**

#### 4. Electrical requirements

**Observe all governing codes and ordinances.** A 120 Volt, 60 Hz, AC only, 15 or 20 amp fused electrical supply is required. (Time-delay fuse is

recommended.) It is recommended that a separate circuit serving only this appliance be provided.

## 5. GROUNDING INSTRUCTIONS

### **⚠ WARNING**

#### Electrical Shock Hazard

**Improper use of the grounding plug can result in a risk of electrical shock. DO NOT, UNDER ANY CIRCUMSTANCES, REMOVE THE POWER SUPPLY CORD GROUNDING PRONG.**

6. For your personal safety, this appliance must be grounded. In the event of an electrical short circuit, grounding reduces the risk of electrical shock by providing an escape wire for the electric current. This appliance is equipped with a polarized 3-prong grounding plug. It must be plugged into a correctly polarized mating 3-prong grounding type wall receptacle, properly installed and grounded in accordance with the National Electrical Code and local codes and ordinances. If a mating wall receptacle is not available or if you are not sure if the wall receptacle is properly grounded and polarized, have it checked by a qualified electrician.

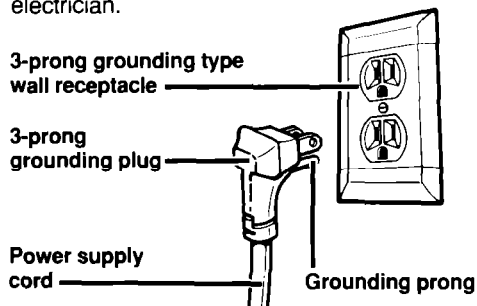

It is the personal responsibility and obligation of the customer to have a properly grounded and correctly polarized 3-prong wall receptacle installed by a qualified electrician.

Consult a qualified electrician if the grounding instructions are not completely understood, or if doubt exists as to whether the appliance is properly grounded.

**It is not recommended to use an extension cord with your microwave oven, but if you find it necessary to do so temporarily (until a properly grounded and polarized 3-prong receptacle is installed), use only a heavy duty UL listed 3-wire grounding type extension cord containing three 16-gauge (minimum) copper wires.** It must not be longer than 10 feet (cords longer than 10 feet may affect the cooking performance of your microwave oven). The plug on the extension cord must fit into a 3-prong grounding type wall receptacle (as shown on this page) and the receptacle end of the extension cord must accept the 3-prong grounding plug of the microwave oven.



7. To test the oven, plug it into the proper electrical outlet. Put about one cup (250mL) of cold water in a glass container in the oven.

Close the door. Make sure it latches. Follow the directions on page 12 to set the oven to COOK for 2 minutes. When the time is up, the water should be heated.

8. **This microwave oven is designed for use in the household only and must not be used for commercial purposes.**

**Do not** remove the door, control panel or cabinet at any time. The unit is equipped with high voltage and should not be serviced unless by an authorized Whirlpool<sup>SM</sup> service technician.

# - SAVE THESE INSTRUCTIONS -

# Caring For Your Microwave Oven

## Cleaning the microwave oven

Wipe often with warm sudsy water and a soft cloth or sponge. The glass turntable may be removed for cleaning. Wash by hand in mild detergent or in a dishwasher. **Do not** operate the microwave oven when turntable is removed for cleaning.

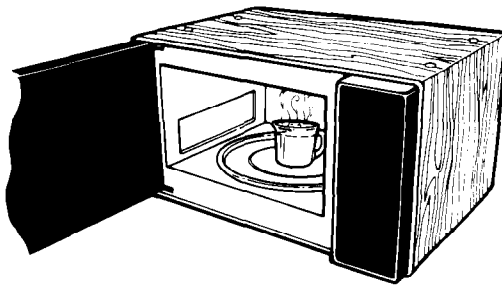
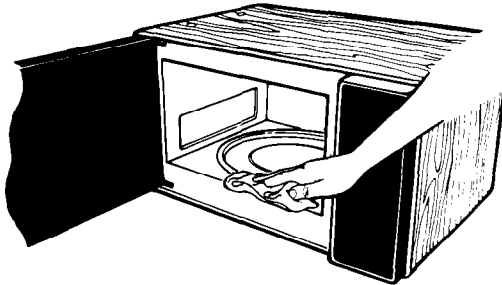

For stubborn soil, boil a cup of water in the oven for 2 or 3 minutes. Steam will soften the soil.

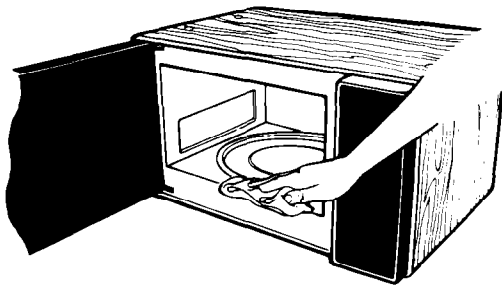

**Be sure to keep the areas clean where the door and oven frame touch when closed.** Use only mild, non-abrasive soaps or detergents applied with a sponge or soft cloth when cleaning surfaces. Rinse well.

### **⚠ CAUTION**

**Abrasive cleansers, steel wool pads, gritty wash cloths, etc., can damage the control panel, and the interior and exterior oven surfaces. Use a soft cloth or a sponge with a mild detergent or spray glass cleaner.**



# How Your Microwave Oven Works

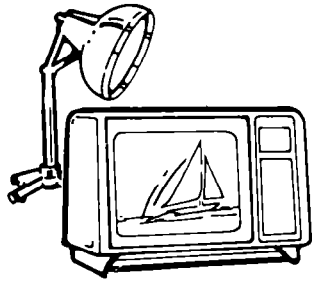

Microwave ovens are safe. Microwave energy is not hot. It causes food to make its own heat, and it's this heat that cooks the food.

Microwaves are like TV waves or light waves. You can't see them, but you can see what they do.

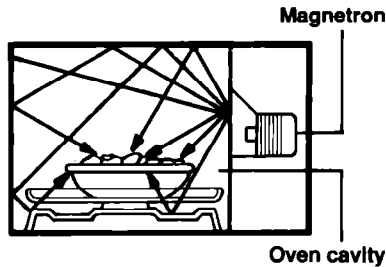

The glass turntable of your microwave oven lets microwaves through. Then they bounce off a metal floor, back through the glass turntable and are absorbed by the food.

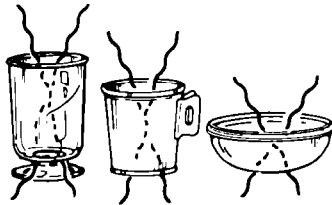

Microwaves pass through glass, paper and most plastics without heating them so food absorbs the energy. Microwaves bounce off metal pans so food does not absorb the energy.



Microwaves may not reach the center of a roast. The heat around the outside is what cooks the roast all the way through. This is one of the reasons for letting some foods (roasts, baked potatoes) stand for a while after cooking, or for stirring some foods during the cooking time.

The microwaves disturb water molecules in the food. As the molecules bounce around bumping into each other, heat is made, like rubbing your hands together. This is the heat that does the cooking.

# Operating Safety Precautions

## **⚠ WARNING**

To reduce the risk of fire, electrical shock, injury to persons, or damage when using the microwave oven, follow the precautions on page 34-37.

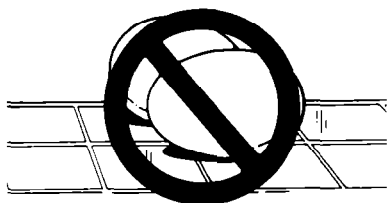

**Never cook or reheat a whole egg.** Steam build-up in whole eggs may cause them to burst and burn you, and possibly damage the oven. Slice hard boiled eggs before heating. In rare instances, poached eggs have been known to explode. Cover poached eggs and allow a standing time of one minute before cutting into them.



Liquids heated in certain containers (especially cylindrical-shaped containers) may become overheated. The liquid may splash out with a loud noise during or after heating or when adding ingredients (coffee, etc.) resulting in harm to the oven and possible personal injury. For best results stir any liquid several times before heating or reheating.

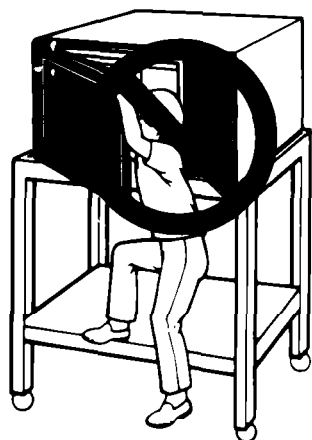

**Never** lean on the door or allow a child to swing on it when the door is open. Injury could result.

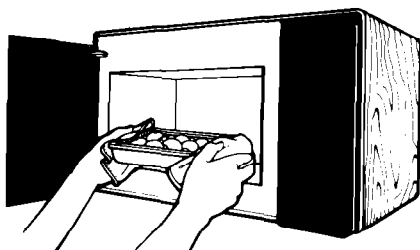

**Use hot pads.** Microwave energy does not heat containers, but the hot food does.

**Do not** heat, store or use flammable materials in or near the oven. The fumes can create a fire hazard or explosion.

**Do not** do canning of foods in the oven. Closed glass jars may explode resulting in damage to the oven or possible personal injury.

**Do not** use the oven to sterilize objects (baby bottles, etc.). It is difficult to maintain the high temperature required for safe sterilization.

**Do not** deep fry in the oven. Microwavable utensils are not suitable and it is difficult to maintain appropriate deep frying temperatures.

**Do not** use the oven for storage. Do not leave paper products, books or cooking utensils in the oven when not in use. Fire may result if someone accidentally starts the oven.

**Do not** let food or containers touch the top or sides of the oven.

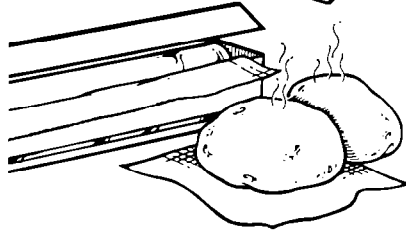
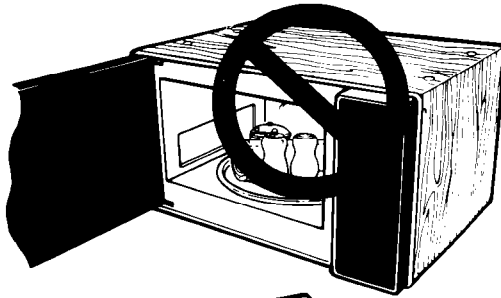

**Do not overcook potatoes.** Fire could result. At the end of the recommended cooking time they should be slightly firm.

Wrap in foil and set aside for 5 minutes. They will finish cooking while standing.

If a fire should start in the oven cavity:

- **do not open oven door**
- **turn oven off**
- **unplug the oven or turn off the power at the main power supply.**

**Do not** place anything within five inches of the left side of the oven. Damage to the oven may result.

Air vents

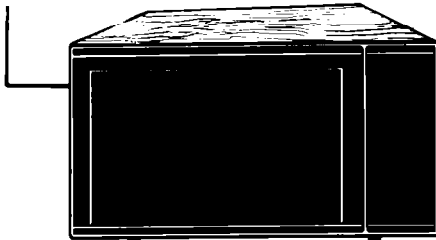

**Operating Safety Precautions  
Continued**

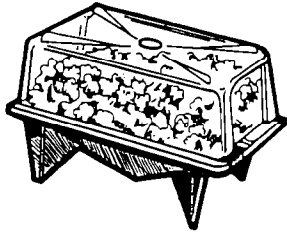

**Do not** pop popcorn, except in a microwave approved popcorn popper or commercial package designed especially for microwave ovens. Follow directions supplied with the popper.

**Never** try to pop popcorn in a paper bag. Overcooking may result in smoke and fire.

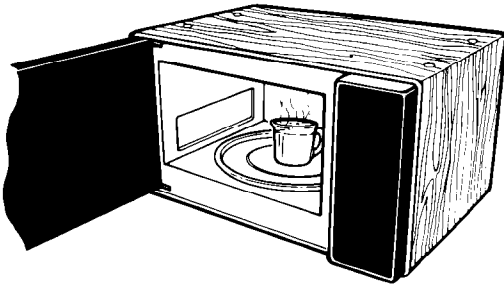

Starting a microwave oven when it's empty is not recommended.

If you experiment, put a container of water in the oven.

It is normal for the inside of the oven door to look wavy after the oven has been running for a while.

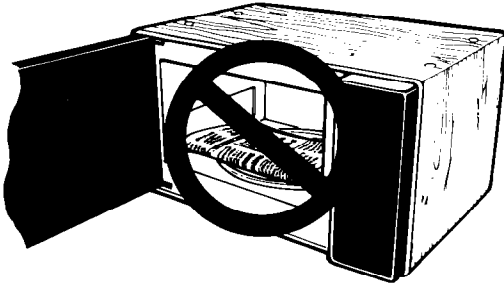

**Do not** use newspaper or other printed paper in the oven. Fire could result.

**Do not** dry flowers, fruit, herbs, wood, paper, gourds or clothes in the oven. Fire could result.

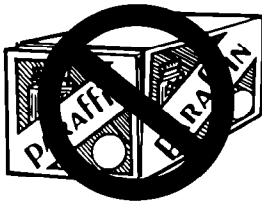

**Do not** try to melt paraffin wax in the oven. You may be burned because paraffin wax will not melt.

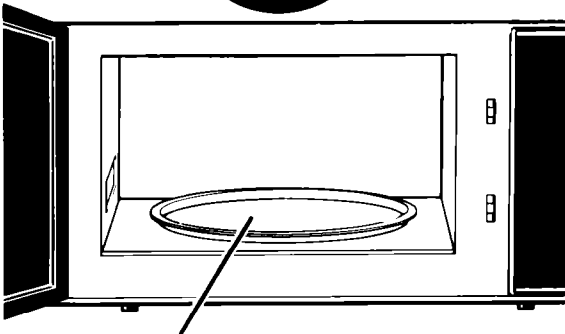

Glass turntable

**Glass turntable**

**Do not** operate the microwave oven unless the glass turntable is securely in place and can rotate freely. The turntable can turn in either direction.

**Carefully** place cookware on glass turntable to avoid possible breakage.

**Handle glass turntable with care** when removing from oven to avoid possible breakage.

When a browning dish is used, the browning dish bottom must be at least 3/16 inch above the glass turntable.

## General information

If your electric power line or outlet voltage is less than the normal 120 volts, cooking times may be longer.

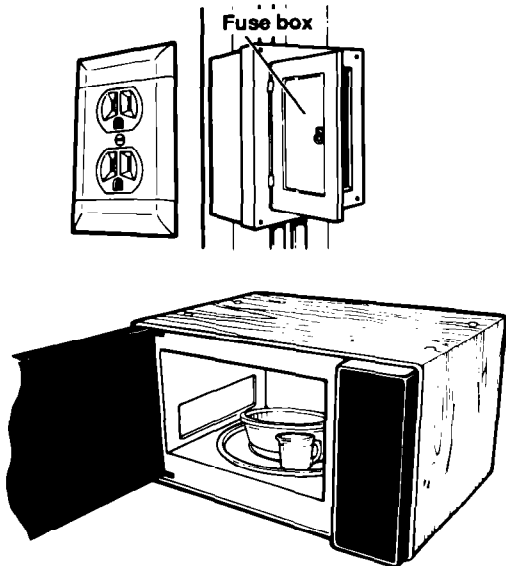

**To test a dish for safe use**, put it into the oven with a cup of water **beside it**. Cook on HIGH Cook Power for one minute. **If the dish gets hot and water stays cool, do not use it.**

# If You Need Service Or Assistance...

## We suggest you follow these steps:

### 1. Before calling for assistance...

Performance problems often result from little things you can find and fix without tools of any kind.

#### **If nothing operates:**

- Is the power supply cord plugged into a live circuit with the proper voltage? (See Installation Instructions.)
- Have you checked your home's main fuses or circuit breaker box?
- Have you checked the electric company for a power failure?

#### **If the microwave oven will not run:**

- Is the oven being used as a timer?
- Is the door firmly closed and latched?
- Did you touch START?
- Did you follow the directions exactly?

#### **If the microwave cooking times seem too long:**

- Is the electric supply to your home or wall outlets low or lower than normal? Your electric company can tell you if the line voltage is low. Your electrician or service technician can tell you if the outlet voltage is low.
- Is the Cook Power at the recommended setting?
- Are you allowing for more time when cooking more food at one time?

#### **If the Display shows a time counting down but the oven is not cooking:**

- Is the oven door closed completely?
- Have you set the controls as a minute timer?
- Is the oven in standing time between QUICK DEFROST and COOK 1? (See page 17.)

#### **If you do not hear the programming tone:**

- Is the command correct?
- Has the tone been cancelled? (See page 10.)

#### **If the fan seems to be running slower than usual:**

- Has the oven been stored in a cold area? The fan will run slower until the oven warms up to normal room temperature.

#### **If there has been a power interruption, the Display will show 88:88. Reset the clock. (See page 11.)**

**2. If you need assistance\*...  
Call Whirlpool COOL-LINE® service assistance  
telephone number. Dial free from anywhere in  
the U.S.:**

**1-800-253-1301**

and talk with one of our trained consultants. The consultant can instruct you in how to obtain satisfactory operation from your appliance, or if service is necessary, recommend a qualified service company in your area.

If you prefer, write to:  
Mr. Donald Skinner  
Director of Consumer Relations  
Whirlpool Corporation  
2000 M-63  
Benton Harbor, MI 49022

Please include a daytime phone number in your correspondence.

**3. If you need service\*...**



Whirlpool has a nationwide network of authorized Whirlpool™ service companies. Whirlpool service technicians are trained to fulfill the

product warranty and provide after-warranty service, anywhere in the United States. To locate the authorized Whirlpool service company in your area, call our COOL-LINE® service assistance telephone number (see Step 2) or look in your telephone directory Yellow Pages under:

APPLIANCES-HOUSEHOLD-  
MAJOR-SERVICE & REPAIR

ELECTRICAL APPLIANCES-  
MAJOR-REPAIRING & PARTS

OR

WASHING MACHINES, DRYERS  
& IRONERS-SERVICING

WHIRLPOOL APPLIANCES  
AUTHORIZED WHIRLPOOL SERVICE

SERVICE COMPANIES  
XYZ SERVICE CO.  
123 MAPLE ..... 999-9999

**4. If you are not satisfied with how the  
problem was solved\*...**

- Contact the Major Appliance Consumer Action Panel (MACAP). MACAP is a group of independent consumer experts that voices consumer views at the highest levels of the major appliance industry.
- Contact MACAP only when the dealer, authorized servicer or Whirlpool have failed to resolve your problem.  
Major Appliance Consumer  
Action Panel  
20 North Wacker Drive  
Chicago, IL 60606
- MACAP will in turn inform us of your action.

- \* When requesting assistance, please provide: model number, serial number, date of purchase, and a complete description of the problem. This information is needed in order to better respond to your request.

# WHIRLPOOL® Microwave Oven Warranty

MW002

LENGTH OF WARRANTY	WHIRLPOOL WILL PAY FOR
<b>FULL ONE-YEAR WARRANTY</b> From Date of Purchase	FSP® replacement parts and repair labor to correct defects in materials or workmanship. Service must be provided by an authorized Whirlpool <sup>SM</sup> service company.
<b>LIMITED FOUR-YEAR WARRANTY</b> Second Through Fifth Year From Date of Purchase	FSP® replacement magnetron tube on microwave ovens if defective in materials or workmanship.
<b>WHIRLPOOL WILL NOT PAY FOR</b>	
<p><b>A.</b> Service calls to:</p> <ol style="list-style-type: none"> <li>1. Correct the installation of the microwave oven.</li> <li>2. Instruct you how to use the microwave oven.</li> <li>3. Replace house fuses or correct house wiring.</li> <li>4. Replace owner accessible light bulbs.</li> </ol> <p><b>B.</b> Repairs when microwave oven is used in other than normal, single-family household use.</p> <p><b>C.</b> Pick-up and delivery. This product is designed to be repaired in the home.</p> <p><b>D.</b> Damage to microwave oven caused by accident, misuse, fire, flood, acts of God or use of products not approved by Whirlpool.</p> <p><b>E.</b> Any labor costs during limited warranties.</p>	

WHIRLPOOL CORPORATION SHALL NOT BE LIABLE FOR INCIDENTAL OR CONSEQUENTIAL DAMAGES. Some states do not allow the exclusion or limitation of incidental or consequential damages so this limitation or exclusion may not apply to you. This warranty gives you specific legal rights, and you may also have other rights which vary from state to state.

Outside the United States, a different warranty may apply. For details, please contact your franchised Whirlpool distributor or military exchange.

If you need service, first see the "Service and Assistance" section of this book. After checking "Service and Assistance," additional help can be found by calling our COOL-LINE® service assistance telephone number, 1-800-253-1301, from anywhere in the U.S.

® Registered Trademark/SM Service Mark of Whirlpool Corporation.