

Use & Care Guide  
Guía de uso y cuidada  
English / Español

Model/Modelos: 790. 9218\*

# Kenmore®

## Induction Range

### Estufa de inducción

\* = color number, código de color

P/N 316902020

Sears Brands Management Corporation  
Hoffman Estates, IL 60179 U.S.A.

[www.kenmore.com](http://www.kenmore.com)  
[www.sears.com](http://www.sears.com)



## Table of Contents

Appliance Warranty .....	2	Setting silent or audible control mode .....	20
Important Safety Instructions .....	3-6	Setting Oven Lockout .....	20
Product Record/Serial Plate Location .....	6	Setting Preheat .....	21
Range Features .....	7	Setting Bake .....	21
Before Setting Oven Controls .....	8	Setting Cook Time .....	22
Removing, replacing & arranging the oven racks .....	7	Setting Delay Start .....	22
Before Setting Surface Controls .....	9-11	Setting Conv Bake .....	23
Induction cooking zones .....	9	Setting Conv Roast .....	24
Cooktop display windows .....	10	Setting Conv Convert .....	24
Cooktop Lock feature .....	11	Setting Broil .....	25
Cooktop operational noises .....	11	Setting Slow Cook .....	26
Surface Cookware Recommendations .....	12	Using AirGuard™ feature .....	26
Induction Cooking Zones .....	13-15	Warm & Hold™ .....	27
Pan sensing .....	13	Recipe Recall .....	27
Cooking zone minimum and maximum cookware sizes .....	14	Adjusting oven temperature .....	28
Power sharing .....	15	Restoring factory default settings .....	28
Setting Surface Controls .....	16-17	Setting the Sabbath feature .....	29-30
Setting induction cooking zones .....	16-17	Warmer Drawer .....	31-32
Oven Control Functions .....	18	Flex Clean .....	33-34
Setting Oven Controls .....	19-30	Care & Cleaning .....	35-38
Setting clock .....	19	Cleaning recommendation table .....	35
Setting timer .....	19	Cooktop maintenance .....	36
Add 1 minute .....	19	Cooktop cleaning .....	36-37
Setting 12 or 24 hour display mode .....	19	Before You Call - Solutions to common problems .....	39-41
Changing between continuous bake setting or 12-Hour		Master Protection Agreements .....	42
Energy Saving feature .....	19	Sears Service .....	back cover
Changing oven temperature display (F° or C°) .....	20		

## Kenmore Limited Warranty

When installed, operated and maintained according to all instructions supplied with the product, if this appliance fails due to a defect in material and workmanship within one year from the date of purchase, call 1-800-4-MY-HOME® to arrange for free repair. This warranty applies for only 90 days from the date of purchase if this appliance is ever used for other than private family purposes.

### **This warranty covers only defects in material and workmanship. Sears will NOT pay for:**

1. Cracks in a ceramic glass cooktop that are not a result of thermal shock.
2. Stains and scratches on a ceramic glass cooktop resulting from failure to maintain it properly according to all instructions supplied with the product.
3. Expendable items that can wear out from normal use, including but not limited to filters, belts, light bulbs, and bags.
4. A service technician to instruct the user in correct product installation, operation or maintenance.
5. A service technician to clean or maintain this product.
6. Damage to or failure of this product if it is not installed, operated or maintained according to all instructions supplied with the product.
7. Damage to or failure of this product resulting from accident, abuse, misuse or use for other than its intended purpose.
8. Damage to or failure of this product caused by the use of detergents, cleaners, chemicals or utensils other than those recommended in all instructions supplied with the product.
9. Damage to or failure of parts or systems resulting from unauthorized modifications made to this product.

### **Disclaimer of implied warranties; limitation of remedies**

Customer's sole and exclusive remedy under this limited warranty shall be product repair as provided herein. Implied warranties, including warranties of merchantability or fitness for a particular purpose, are limited to one year or the shortest period allowed by law. Sears shall not be liable for incidental or consequential damages. Some states and provinces do not allow the exclusion or limitation of incidental or consequential damages, or limitation on the duration of implied warranties of merchantability or fitness, so these exclusions or limitations may not apply to you.

This warranty applies only while this appliance is used in the United States or Canada.

This warranty gives you specific legal rights, and you may also have other rights which vary from state to state.

**Sears Brands Management Corporation, Hoffman Estates, IL 60179 U.S.A.**

**Sears Canada Inc., Toronto, Ontario, Canada M5B 2B8**

All rights reserved. Printed in the USA.

# Important Safety Instructions

## Read all instructions before using this appliance.

This manual contains important safety symbols and instructions. Please pay attention to these symbols and follow all instructions given.

### Definitions

**⚠** This is the safety alert symbol. It is used to alert you to potential personal injury hazards. Obey all safety messages that follow this symbol to avoid possible injury or death.

Do not attempt to install or operate your appliance until you have read the safety precautions in this manual. Safety items throughout this manual are labeled with a **WARNING** or **CAUTION** statement based on the risk type.

**⚠ WARNING** - indicates a potentially hazardous situation which, if not avoided, may result in death or serious injury.

**⚠ CAUTION** - indicates a potentially hazardous situation which, if not avoided, may result in minor or moderate injury.

**⚠ CAUTION** Persons with a pacemaker or similar medical device should exercise caution using or standing near an induction unit while it is in operation, as the electromagnetic field may affect the working of the pacemaker or similar medical device. It would be advisable to consult your Doctor or the pacemaker or similar medical device manufacturer about your particular situation.

This appliance has been tested and found to comply with the limits for a class B digital device, pursuant to Part 18 of the FCC rules. These limits are designed to provide reasonable protection against harmful interference in a residential installation. This unit generates, uses and can radiate radio frequency energy and, if not installed and used in accordance with the instructions, may cause harmful interference to radio communications. However there is no guarantee that interference will not occur in a particular installation. If this unit does cause harmful interference to radio or television reception, which can be determined by turning the unit off and on, the user is encouraged to try to correct the interference by one or more of the following measures:

- Reorient or relocate the receiving antennae.
- Increase the distance between the unit and receiver.
- Connect the unit into an outlet or a circuit different from that to which the receiver is connected.

### **⚠ WARNING**

#### Tip Over Hazard

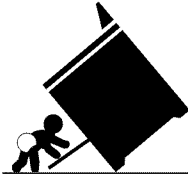

- A child or adult can tip the range and be killed.
- Verify the anti-tip device has been installed to floor or wall.

- Ensure the anti-tip device is re-engaged when the range is moved to floor or wall.
- Do not operate the range without the anti-tip device in place and engaged.
- Failure to follow these instructions can result in death or serious burns to children and adults.

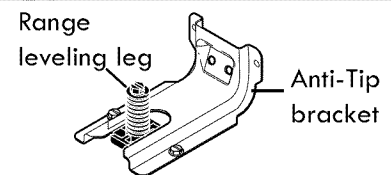

To check if the anti-tip bracket is installed properly, use both arms and grasp the rear edge of range back. Carefully attempt to tilt range forward. When properly installed, the range should not tilt forward.

Refer to the anti-tip bracket **installation instructions** supplied with your range for proper installation.

- **Remove all tape and packaging before using the range.** Destroy the carton and plastic bags after unpacking the range. Never allow children to play with packaging material.
- **Proper installation—Be sure your appliance is properly installed and grounded by a qualified technician in accordance with the National Electrical Code ANSI/NFPA No. 70 latest edition and local electrical code requirements.** Install only per installation instructions provided in the literature package for this range.
- **User servicing—Do not repair or replace any part of the appliance unless specifically recommended in the manuals.** All other servicing should be done only by a qualified technician, This may reduce the risk of personal injury and damage to the range.

Ask your dealer to recommend a qualified technician and an authorized repair service. Know how to disconnect the power to the range at the circuit breaker or fuse box in case of an emergency.

**Save these instructions for future reference.**

# Important Safety Instructions

- **Never modify or alter the construction of a range by removing the leveling legs, panels, wire covers, anti-tip brackets/screws, or any other part of the range.**
- Remove the oven door from any unused range if it is to be stored or discarded.
- **Do not attempt to operate the range during a power failure.** If the power fails, always turn off the range. If the range is not turned off and the power resumes, the range will begin to operate again. Once the power resumes, reset the clock and oven function.

**⚠ WARNING** Stepping, leaning or sitting on the door or drawers of a range can result in serious injuries and also cause damage to the appliance. **DO NOT** allow children to climb or play around the range. The weight of a child on an open oven door may cause the range to tip, resulting in serious burns or other injury.

**⚠ WARNING** Storage in or on appliance — flammable materials should not be stored in an oven, near surface units or in the storage drawer, warmer drawer or lower oven. This includes paper, plastic and cloth items, such as cookbooks, plasticware and towels, as well as flammable liquids. Do not store explosives, such as aerosol cans, on or near the range.

**⚠ WARNING** NEVER cover any slots, holes or passages in the oven bottom or cover an entire oven rack with materials such as aluminum foil. Aluminum foil linings may trap heat, causing a fire hazard.

**⚠ WARNING** DO NOT LEAVE CHILDREN ALONE — children should not be left alone or unattended in the area where appliance is in use. They should never be allowed to sit or stand on any part of the appliance, including the storage drawer, lower broiler drawer, warmer drawer or lower double oven.

**⚠ CAUTION** Do not store items of interest to children in the cabinets above a range or on the backguard of the range. Children climbing on the range to reach items could be seriously injured.

**⚠ CAUTION** DO NOT TOUCH SURFACE HEATING UNITS, OR SURFACE COOKING ELEMENTS, AREAS NEAR THESE SURFACE HEATING UNITS, OR INTERIOR SURFACE OF THE OVEN. Both surface units and oven heating elements may be hot even though they are dark in color. Areas near surface cooking units may become hot enough to cause burns. During and after use, do not touch, or let clothing or other flammable materials touch these areas until they have had sufficient time to cool. Among these areas are the cook top, surfaces facing the cook top, the oven vent openings and surfaces near these openings, oven door and oven door window.

**⚠ CAUTION** Wear proper apparel — loose-fitting or hanging garments should never be worn while using the appliance. Do not let clothing or other flammable materials contact hot surfaces.

**⚠ CAUTION** DO NOT USE WATER OR FLOUR on grease fires — smother the fire with a pan lid, or use baking soda, a dry chemical or foam-type extinguisher.

**⚠ CAUTION** When heating fat or grease, watch it closely. Fat or grease may catch fire if allowed to become too hot.

**⚠ CAUTION** Use dry potholders — moist or damp potholders on hot surfaces may result in burns from steam. Do not let potholders touch hot heating elements. Do not use a towel or other bulky cloth instead of a potholder.

**⚠ CAUTION** Do not heat unopened food containers — buildup of pressure may cause container to burst and result in injury.

## Important Safety Notice

The California Safe Drinking Water and Toxic Enforcement Act requires the Governor of California to publish a list of substances known to the state to cause cancer, birth defects or other reproductive harm, and requires businesses to warn customers of potential exposure to such substances.

Save these instructions for future reference.

# Important Safety Instructions

## IMPORTANT INSTRUCTIONS FOR USING YOUR OVEN

**⚠ WARNING** Protective Liners — **DO NOT USE ALUMINUM FOIL** to line the oven bottom. Only use aluminum foil as recommended in this manual. Improper installation of these liners may result in risk of electric shock, or fire.

- **Use care when opening oven door, warmer drawer or lower oven door** — Stand to the side of the range when opening the door of a hot oven. Let hot air or steam escape before you remove or replace food in the oven.
- **Keep oven vent ducts unobstructed.** The oven vent is located below the backguard. Touching the surfaces in this area when the oven is operating may cause severe burns. Also, do not place plastic or heat-sensitive items on or near the oven vent. These items could melt or ignite.
- **Placement of interior oven racks.** Always place oven racks in desired location while oven is cool. If rack must be moved while oven is hot use extreme caution. Use potholders and grasp the rack with both hands to reposition. Do not let potholders contact the hot heating elements in the oven. Remove all utensils from the rack before moving.
- **Do not use the broiler pan without its insert.** The broiler pan and its insert allow dripping fat to drain and be kept away from the high heat of the broiler.
- **Do not cover the broiler insert with aluminum foil.** Exposed fat and grease could ignite.

## IMPORTANT INSTRUCTIONS FOR CERAMIC-GLASS COOK TOP MODELS

- **Do not cook on broken cook top**—If cook top should break, cleaning solutions and spillovers may penetrate the broken cook top and create a risk of electric shock. Contact a qualified technician immediately.
- **Clean cook top with caution**—If a wet sponge or cloth is used to wipe spills on a hot cooking area, be careful to avoid a steam burn. Some cleaners can produce noxious fumes if applied to a hot surface.

## IMPORTANT INSTRUCTIONS FOR USING YOUR COOKTOP

- **Know which knob or keypad controls each surface heating unit.** Place a pan of food on the surface element or heating unit before turning it on, and turn the element or heating unit off before removing the pan.
- **Use proper pan size for induction cooking zones** —This appliance is equipped with one or more induction cooking zones of different sizes. Select utensils specifically manufactured and approved for induction cooking that have flat bottoms that match the induction cooking zone size. Proper relationship of utensil to cooking zone will also improve efficiency.
- **Utensil handles should be turned inward and not extend over adjacent surface elements** or cooking zones — To reduce the risk of burns, ignition of flammable materials, and spillage due to unintentional contact with the utensil, the handle of the utensil should be positioned so that it is turned inward, and does not extend over adjacent surface units.
- **Never leave surface elements or cooking zones at high heat settings or with active power level settings unattended** — Boilovers cause smoking and greasy spillovers that may ignite, or a pan that has boiled dry may melt.
- **Glazed cooking utensils** — Only certain types of glass, glass/ceramic, ceramic, earthenware, or other glazed utensils are suitable for cook top service without breaking due to the sudden change in temperature. Check the manufacturer's recommendations for cook top use.
- **When flaming foods under a ventilating hood, turn the fan on.**

Save these instructions for future reference.

# Important Safety Instructions

## IMPORTANT INSTRUCTIONS FOR CLEANING YOUR RANGE

**⚠ CAUTION** Before manually cleaning any part of the range, be sure all controls are turned OFF and the range is COOL. **The range may be hot** and can cause burns.

- **Clean the range regularly to keep all parts free of grease that could catch fire.** Pay particular attention to the area around each surface element or cooking zone. Do not allow grease to accumulate.
- **Kitchen cleaners and aerosols — Always follow the manufacturer's recommended directions for use.** Be aware that excess residue from cleaners and aerosols may ignite causing damage and injury.
- **Clean ventilating hoods frequently — Grease should not be allowed to accumulate on the hood or filter.** Follow the manufacturer's instructions for cleaning hoods.

## IMPORTANT INSTRUCTIONS FOR SELF-CLEANING OVENS

- **Clean in the self-cleaning cycle only the parts listed in this Use & Care Manual.** Before self-cleaning the oven, remove the oven racks, broil pan, broil pan insert and any cookware, cooking utensils or food from the oven.
- **Do Not Use Oven Cleaners** — No commercial oven cleaner or oven liner protective coating of any kind should be used in or around any part of the oven.
- **Do Not Clean Door Gasket** — The door gasket is essential for a good seal. Care should be taken not to rub, damage or move the gasket.
- The health of some birds is extremely sensitive to the fumes given off during the self-cleaning cycle of any range. Move birds to another well-ventilated room.

Save these instructions for future reference.

## Product Record

In this space below, record the date of purchase, model and serial number of your product. You will find the model and serial number printed on an identification plate. **See bottom of this page** for serial plate location.

Model No. 790.

Serial No. \_\_\_\_\_

Date of Purchase \_\_\_\_\_

Save sales receipt for future reference.

## Serial Plate Location

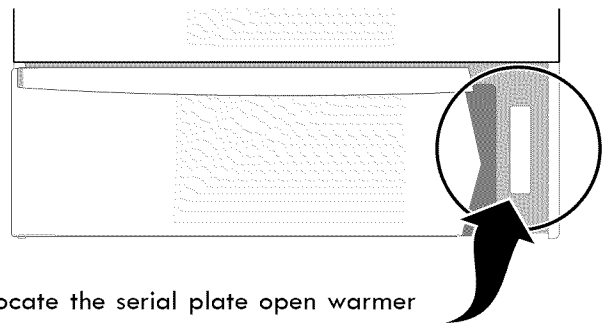

To locate the serial plate open warmer drawer (some models) or storage drawer (some models). The serial plate is attached to the lower right oven frame.

# Range Features

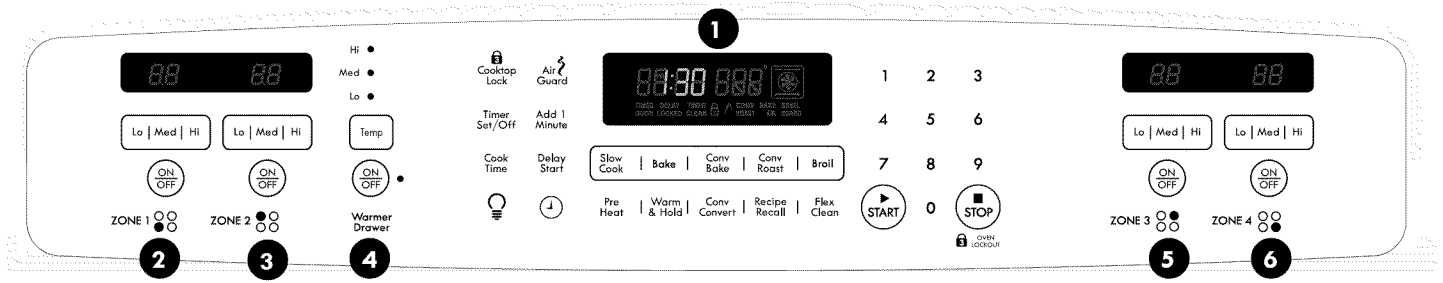

## Your electric range with induction features include:

1. Electronic oven control with kitchen timer.
2. Cooking Zone 1 control.
3. Cooking Zone 2 control.
4. Warm & Ready drawer keypad controls and indicator lights.
5. Cooking Zone 3 control.
6. Cooking Zone 4 control.
7. Easy to clean upswept cooktop.
8. Automatic oven door light switch.
9. Self-clean door latch.
10. Oven interior halogen lights with removable protective shield.
11. Self-cleaning porcelain oven interior.
12. Convection fan and cover.
13. Adjustable interior oven racks.
14. Full width matching oven door handle.
15. Full width oven door with large window.
16. Full width matching Warm & Ready drawer handle.
17. Warm & Ready drawer.
18. Leveling legs and **anti-tip** bracket (included).
19. Ceramic induction smoothtop (cooking zones, styles and color may vary according to model).
20. Induction cooking zone 1.
21. Induction cooking zone 2.
22. Induction cooking zone 3.
23. Induction cooking zone 4.
24. Warm and Ready drawer rack

**Note:** The features shown for your appliance may vary according to model type and color.

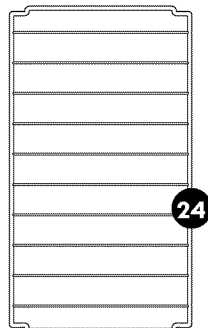
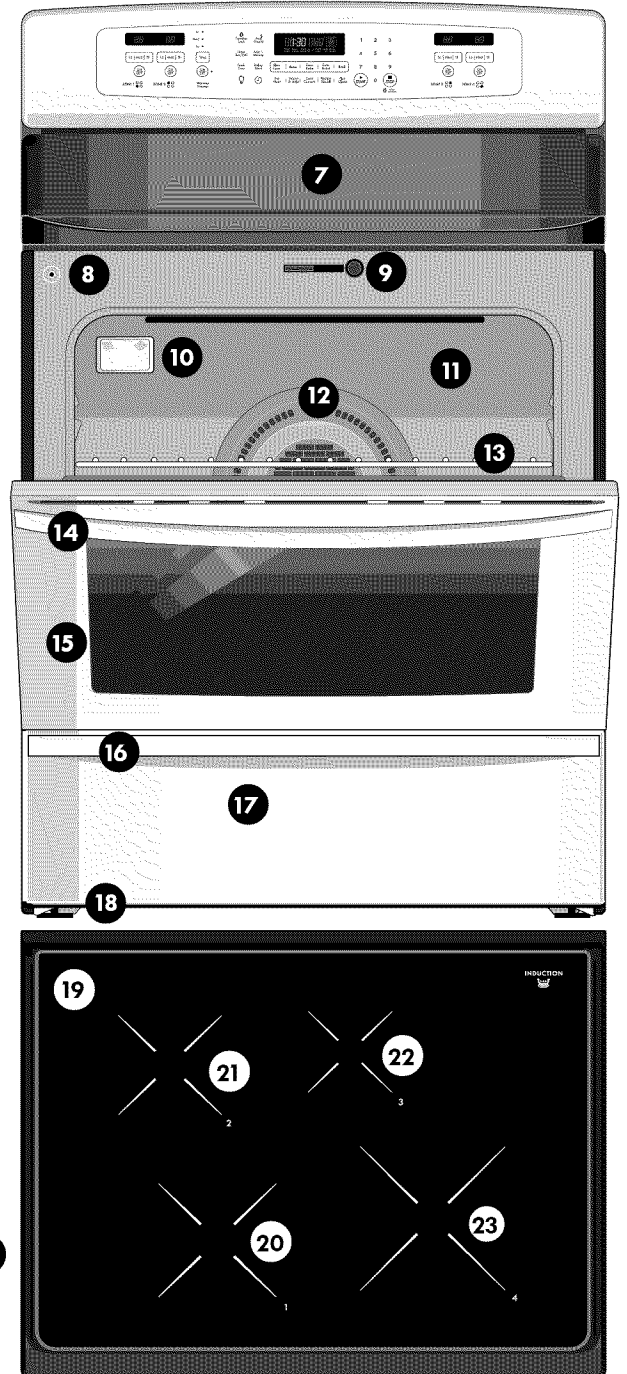

# Before Setting Oven Controls

## Oven vent location

The oven vent is located **under the left side of the control panel** (See Fig. 1). When the oven is on, warm air passes through this vent. This venting is necessary for proper air circulation in the oven and good baking results. **Do not block oven vent.**

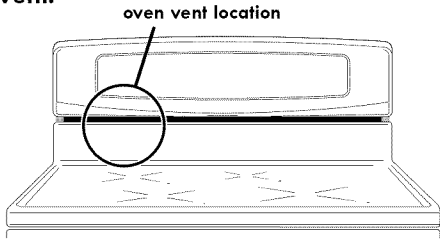

Fig. 1

## Removing, replacing and arranging racks

**CAUTION** Always use pot holders or oven mitts when using the oven. When cooking, the oven interior and exterior, oven racks and cooktop will become very hot which can cause burns.

**WARNING** Protective Liners — **DO NOT USE ALUMINUM FOIL** to line the oven bottom. Only use aluminum foil as recommended in this manual. Improper installation of these liners may result in risk of electric shock, or fire.

**Arranging** - always arrange the oven racks when the oven is cool (prior to operating the oven).

**To remove** - pull the rack forward until it stops. Lift up front of rack and slide out.

**To replace** - fit oven rack onto the rack guides on both sides of oven walls. Tilt the front of oven rack upward and slide the rack back into place. Be sure oven racks are level before using.

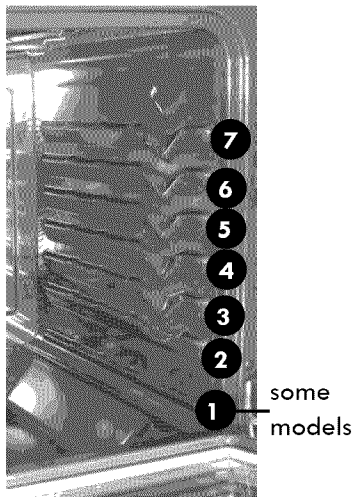
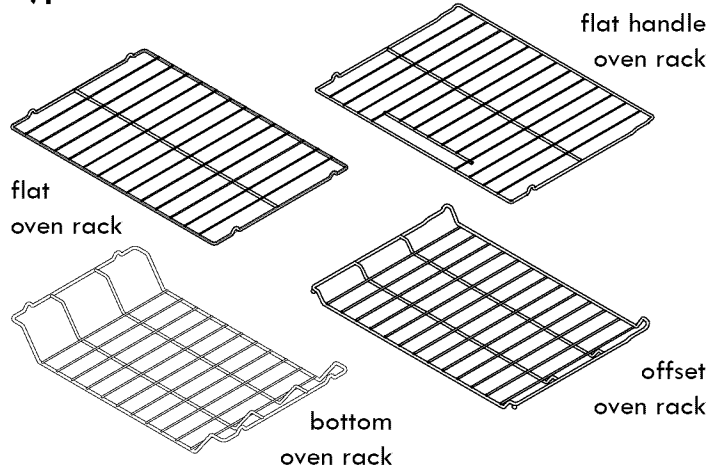

Fig. 2

### Recommended oven rack positions by food type:

Food type	Position
Broiling	See broil
Cookies, cakes, pies, biscuits & muffins	4 or 5
Frozen pies, angel food cake, yeast, bread and casseroles	2 or 3
Small cuts of meat or poultry	1 or 2
Turkey, roast or ham	1 or 2

## Types of oven racks



The **flat oven rack** (some models) or **flat handle oven rack** (some models) may be used for most cooking needs.

The **offset oven rack** (on some models) is designed to place the base of the rack about 1/2 of a rack position lower than flat oven racks. This design provides several additional possible positions between the flat rack positions.

To maximize oven cooking space place the **bottom oven rack** (on some models) in the lowest rack position for roasting large cuts of meat.

## Air circulation in the oven

For best baking results allow 2-4" (5-10 cm) around the cookware for proper air circulation and be sure pans and cookware do not touch each other, the oven door, sides or back of the oven cavity. Hot air must be able to circulate around the cookware in the oven for even heat to reach around the food (See Fig. 3).

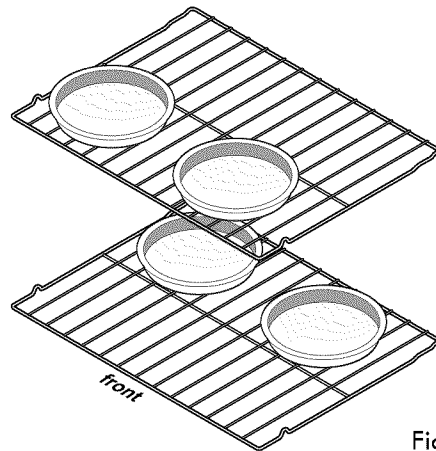

Fig. 3

## Baking layer cakes with 1 or 2 oven racks

For best results when baking cakes or cookies using 2 oven racks, place cookware on rack positions 3 and 6 (6 using the offset oven rack on some models). For best results when baking cakes or cookies using a single oven rack, place cookware on rack position 3 or 4 (See Fig. 2).



## Before Setting Surface Controls

### Induction cooking zones

INDUCTION



#### Benefits of induction cooking zones:

**Fast and efficient** - The induction cooking zones heat faster while using less energy. Induction power levels are quick to boil and efficient when simmering.

**A cooler cooktop** - A unique feature of the induction cooking zones are whether turned on or off, the cooking zones remain cooler than radiant elements. Virtually no wasted heat is produced since the heat begins with the presence of cookware.

**Easy cleanups** - The cooler cooking zone makes cleanups easier. Spills resist sticking or burning so they wipe up easier.

**Magnetic detector** - The cooking zone has a sensor that automatically detects whether cookware is magnetic. This will reduce accidental “turn-ons” and help avoid setting utensils on hot elements like spatulas or spoons.

**Pan size detection** - The pan size recognition sensor automatically detects and adapts the induction cooking zones to the pan sizes in use for consistent, more even cooking.

**More responsive** - The induction cooking zones are more responsive than their electric or gas counterparts because only the pan heats. This type of cooking heats easier and will be just as responsive when reducing to a simmer.

For more information about the cooktop see “Cooktop maintenance” and “Cooktop cleaning” in the **Care & Cleaning** section.

The type and size of cookware, cooking duration, the number of cooking zones in use and their power level settings are all factors that will affect the amount of heat that will spread beyond the cooking zones.

Induction cooking directly heats the pan; heating will only begin when cookware is properly placed on the cooking zones. Your cooktop is marked with four cooking zone numbers for your convenience (See Fig. 1).

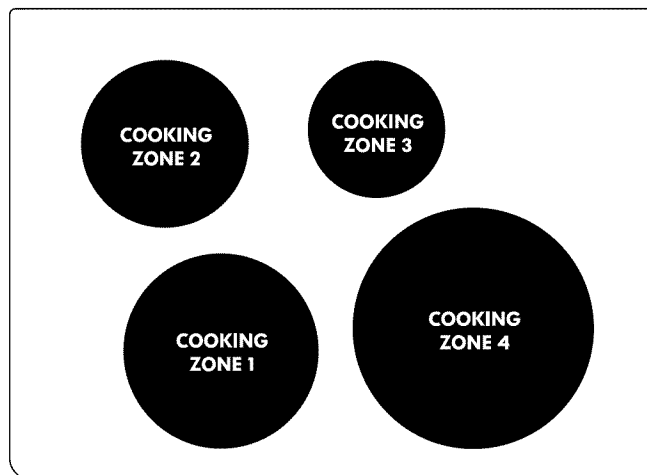

Fig. 1

The cooking zones and areas surrounding the cooking zones may become **hot enough to cause burns**. **Be sure to read all cautions.**

**⚠ CAUTION** The **induction cooking zones** will not glow red when they are **hot**. **The glass surface may be hot** from residual heat transferred from the cookware and burns may occur.

**⚠ CAUTION** **Do not touch hot cookware or pans directly with hands**. Always use oven mitts or pot holders to protect hands from burns.

**⚠ CAUTION** **Do not place flammable items** such as plastic salt and pepper shakers, spoon holders or plastic wrappings on top of the range when it is in use. These items could melt or ignite if placed too close to hot cookware.

## Before Setting Surface Controls

### Cooktop display windows

The cooktop display features provide a digital display for each of the cooking zones located on the cooktop. Power levels and messages are easily controlled and monitored using the **window displays** in combination with the corresponding control touch pads.

#### Available power level settings

The cooktop control will display heat levels ranging from **Pb** (Fig. 1), **Hi** (Fig. 2) to **Lo** (Fig. 3) and **OFF** (Fig. 4).

The settings between **9.5** (Fig. 5) and **3.0** (Fig. 6) decrease or increase in .5 increments.

The settings between **3.0** and **1.2** (Fig. 7) are **simmer** settings which decrease or increase in increments of .2 for more precision at lower heat levels.

Use the "Suggested power level settings table" provided in **Setting Surface Controls** section to determine the correct setting for the type of food you are preparing.

#### Power level settings

When setting an induction cooking zone to the highest level, the display will show **Pb (Power Boost)** power level for up to 10 minutes (See Fig. 1). After 10 minutes the cooking zone will automatically lower to the **Hi** (Fig. 2) setting. The **Pb** setting is only available immediately after activating a cooking zone and pressing the **Hi** power level keypad.

#### Hot surface window message (HE)

After using any of the induction cooking zones the cooktop may become very hot. After turning any of the cooking zones OFF, the cooktop may remain hot for some time. The corresponding **HE** (hot element) message may turn ON indicating one or more of the cooking zones are HOT. This message will turn OFF once the affected cooking zones have cooled sufficiently (See Fig. 8).

#### Cooktop Lock window message ( - - )

The ( - - ) message will appear whenever the **Cooktop Lock** feature is active (See Fig. 9). Refer to the **Cooktop Lock** instructions for more details. When the **Sabbath Day** feature is activated, the cooktop displays will show the **Cooktop Lock** message for all cooking zones.



Fig. 1



Fig. 2



Fig. 3

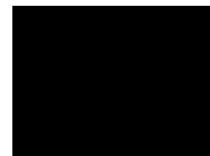

Fig. 4



Fig. 5



Fig. 6



Fig. 7



Fig. 8

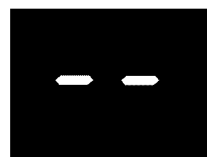

Fig. 9

## Before Setting Surface Controls

### Cooktop Lock feature

Use the **Cooktop Lock** keypad to activate the Cooktop Lock feature. This feature will lock all cooking zones from being accidentally turned ON. This feature will only lock the cooktop.



#### To turn Cooktop Lock feature ON:

1. **Be sure all** cooking zones are set to the OFF position.
2. Press and hold **Cooktop Lock** keypad until a 2nd beep sounds. If a triple beep sounds instead, check all cooking zones and turn them OFF and repeat this step. Once activated the **Cooktop Lock** indicator light (See Fig. 1) will display. The cooktop controls and functions are locked out until the cooktop is unlocked.



Fig. 1

#### To turn Cooktop Lock feature OFF:

1. **Be sure all** cooking zones controls are set to the OFF position.
2. Press and hold **Cooktop Lock** until a 2nd beep sounds (after 3 seconds). The **Cooktop Lock** indicator light will turn OFF and the cooktop may be used for normal cooking operations.

#### Important note:

Starting a Flex Clean cycle will automatically turn ON the Cooktop Lock feature. The cooktop will remain locked until the Flex Clean is finished and the oven door has unlocked. If a power failure occurs after Cooktop Lock has been activated, you must turn OFF the Cooktop Lock feature before the cooktop features will be available again.

### Cooktop operational noises

The electronic processes involved with induction cooking may create some unusual background noises. You could hear a slight “buzz” sound when using the induction cooking zones. These noises are normal and are a part of the induction cooking process.

Some cookware may “buzz” louder depending on the cookware base material and cookware contents. The “buzz” sound may be more noticeable if the contents of the pan are cold. As the cookware heats up, the sound will decrease. If the power level setting is reduced, the sound level will also decrease.

#### Important note:

When using the induction cooktop, operational noises are more noticeable while cooking at the **Pb** level. Very loud noises are not part of normal induction cooking.

# Surface Cookware Recommendations

## Induction cookware

When purchasing pans for use on the induction cooktop, look for cookware specifically identified by the manufacturer for induction cooking, marked as “induction ready” or “induction capable.”

If you are not sure, use a magnet to test (See Fig. 1) whether the cookware material type will work. If a magnet sticks to the bottom of the cookware, the material type is correct.

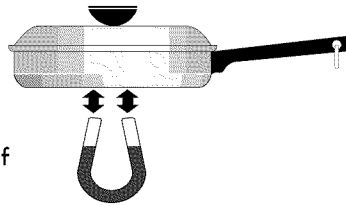

Fig. 1

### Important notes:

- Be sure to follow all the manufacturer’s recommendations when using cookware made for induction cooking.
- Before using the induction cooking zones, be sure to **carefully read and follow** these cookware recommendations and the section about pan sensing.

### Always use quality cookware in good condition

It is recommended to always use heavier high quality magnetic base cookware on induction zones. This will greatly reduce the possibility of developing scratches on the ceramic surface. Even high quality cookware can scratch the cooktop glass, especially if cookware is slid over the ceramic cooktop without being lifted up.

Over time sliding **ANY** type of cookware over the surface will likely alter the overall appearance of the cooktop. Eventually the buildup of scratches will make cleaning the ceramic surface difficult and degrade the overall appearance of the cooktop.

Cookware should have flat bottoms that make good contact with the entire induction cooking zone area. Check for flatness by rotating a ruler (See Fig. 2) across the bottom of the cookware.

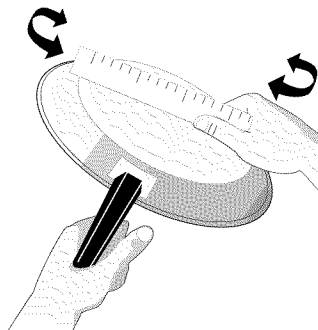

Fig. 2

## Induction cookware types

The most common induction cookware types available:

**Stainless steel** - Generally, excellent for induction cooking. Is durable, easy to clean and resists staining.

**Cast iron** - Good for induction cooking. Cooks evenly. Do not slide cast iron cookware on cooktop. Cast iron cookware with rough surface will scratch ceramic cooktop.

**Porcelain-enamel on ferrous metal** - Heating characteristics will vary depending on base material. Porcelain-enamel coating must be smooth to avoid scratching ceramic cooktop.

### Important notes:

- Not all stainless steel cookware is readily magnetizable; being made of stainless steel does **not** mean that cookware is suitable for induction.
- Do not use **aluminum, copper, glass or non-ferrous metal** cookware on induction cooking zones.

### When using the cooking zones:

- Be sure to use cookware made with a **magnetic base** material.
- Use quality cookware with heavier bottoms for better heat distribution allowing for more even cooking results.
- Always use clean cookware. Also use cookware that is easy to maintain.
- Check that cookware bottom rests completely on induction cooktop and is level. The cookware should have flat bottoms and straight sides.
- Be sure cookware is properly balanced and does not tilt from heavy handle.
- Be sure that the pan size matches the amount of food to be prepared. The size and type of cookware used will influence the setting needed for best cooking results.
- Do not let cookware boil dry. This may cause permanent damage in the form of breakage, fusion, or marring that can affect the cooktop.
- Use cookware that meets the minimum and maximum cookware size requirements for each cooking zone.

# Induction Cooking Zones

## Pan sensing

The cooking zone sensors located below the cooktop surface **require** that certain cookware conditions are met before the induction cooking zones can operate.

The cooking zone display windows may display a pan sensing error message. If a cooking zone was activated and no pan or cookware is detected, the affected induction cooking zone display window will **flash** with the last power level request setting (See Fig. 1).

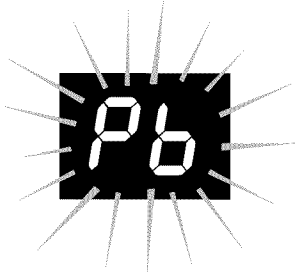

Fig. 1

The cooking zone sensors located below the cooktop surface **require** that certain cookware conditions are met before the induction cooking zones can operate. Be sure to check that the cookware has met all the **correct** conditions listed in Fig. 2. Use this checklist as a guide to help to correct the problem or problems before attempting to reactivate cooking zones.

The conditions that may generate an error message are also illustrated in the **incorrect** column in Fig. 2. If the problem or problems are not corrected the affected cooking zone will automatically deactivate after 3 minutes.

### Important note:

It is recommended that you lower the requested power level setting before correcting the pan sensing message.

## Pan sensing checklist

### Correct conditions

- Cookware base material has good magnetic characteristics.

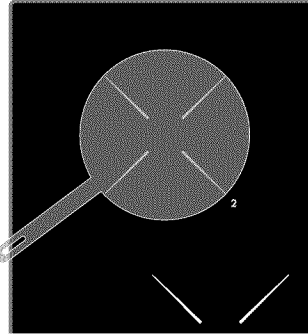

- Cookware centered correctly on cooking zone.

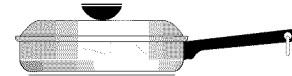

- Flat pan bottom and straight sides.

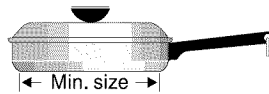

- Pan size meets or exceeds the recommended minimum size for cooking zone.

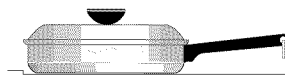

- Pan rests completely and is level on the cooktop surface.

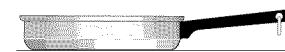

- Pan is properly balanced.

### Incorrect conditions

- Cookware base material is non-magnetic.

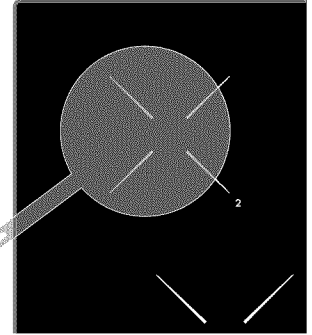

- Cookware not centered on cooking zone.

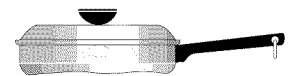

- Curved or warped pan bottoms or sides.

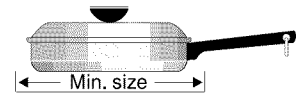

- Pan does not meet the minimum size required (too small) for cooking zone.

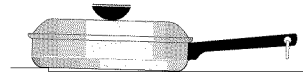

- Pan bottom rests on cooktop edge.

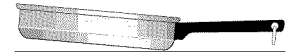

- Heavy handle tilts pan.

Fig. 2

# Induction Cooking Zones

## Induction cooking zone minimum and maximum cookware sizes

### Minimum pan size

Each of the four Induction cooking zones require a **minimum** pan size in order to activate. The cookware bottom must fully cover this minimum area for heating to occur.

If a pan that is induction capable is centered properly but is **too small**, the affected cooking zone display will flash the last power level setting and the pan will not heat. Use a larger pan that meets the minimum size requirement to activate the cooking zone.

The illustration provided (Fig. 1) shows the minimum pan size requirements for each for each cooking zone location.

### Maximum pan size

Use the cooktop graphics provided for each induction cooking zone location to help determine the recommended maximum cookware size.

After centering the cookware on the cooking zone, do not use pans with bottoms that extend more than 1/2" (13mm) outside of the cooking zone patterns provided on the cooktop.

The cookware bottom must make full contact with the ceramic glass surface without cookware touching the metal cooktop sides, rear or front edges.

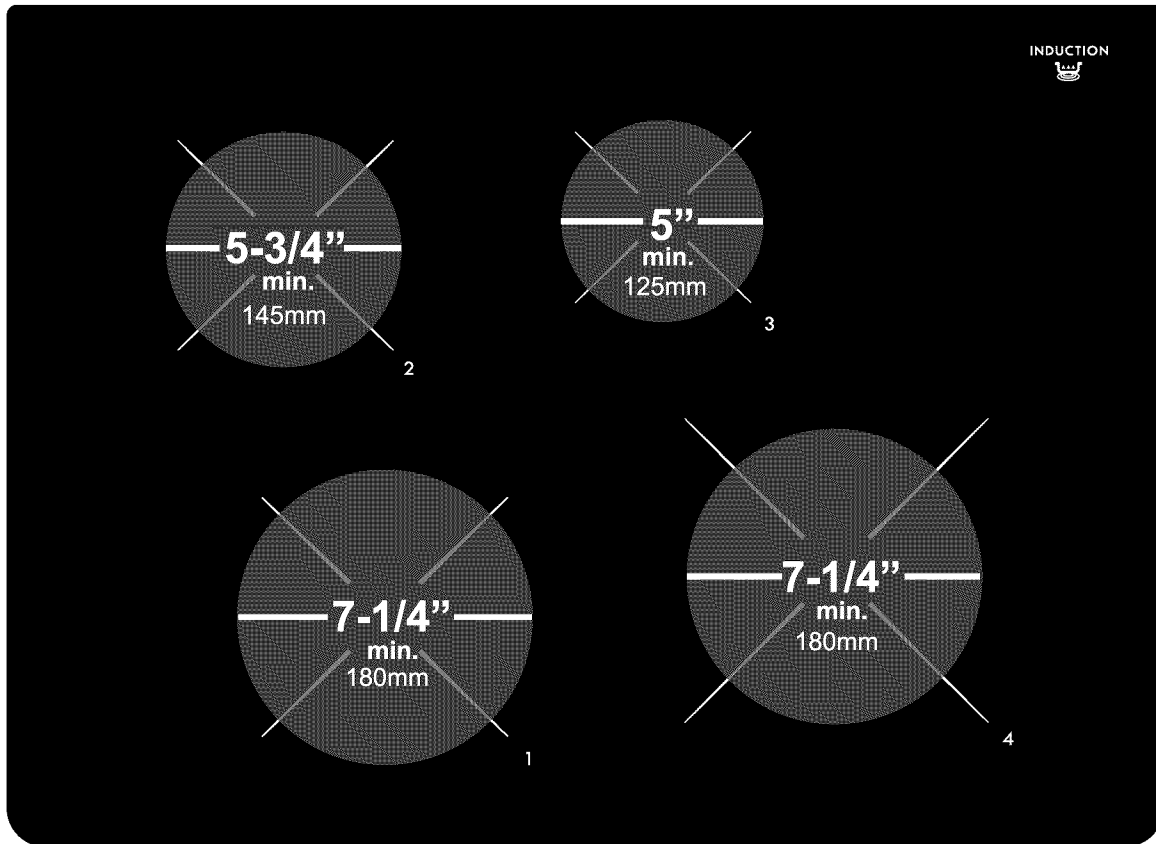

Fig. 1 Minimum pan size requirements

# Induction Cooking Zones

## Power sharing

Your cooktop is equipped with four induction Cooking Zones controlled by two heating sections. The left-hand (Cooking Zones 1 & 2) and the right-hand (Cooking Zones 3 & 4) heating sections are powered by two independent induction inverters - one inverter for each of the two heating sections (See Figs. 1 & 2).

Two Cooking Zones in a heating section share the power of one inverter. This is called **power sharing**.

For example, if 2 pans are heating on Cooking Zones 1 and 2 (left-hand side of cooktop) at the same time, the last power level set will be maintained, while the first pan may experience a slight reduction in the power level setting.

### Power sharing tips:

- When cooking two food items simultaneously on the same side of the cooktop remember to set the power level for the food item you wish to maintain last.
- To maintain power levels for two food items heating at the same time, place one pan on Cooking Zone 1 or 2, and place the other pan on Cooking Zone 3 or 4. This way the cooktop sensors will use both inverters and power level reductions are avoided (See Fig. 3).

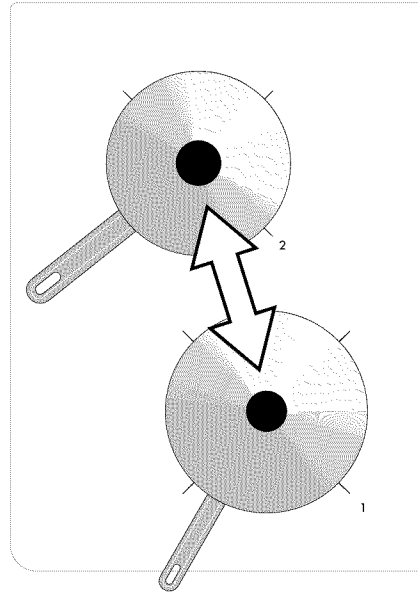

Fig. 1 - Left-hand cooking zones section

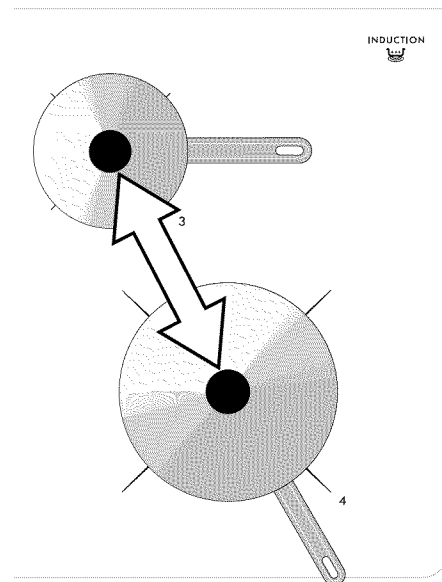

Fig. 2 - Right-hand cooking zones section

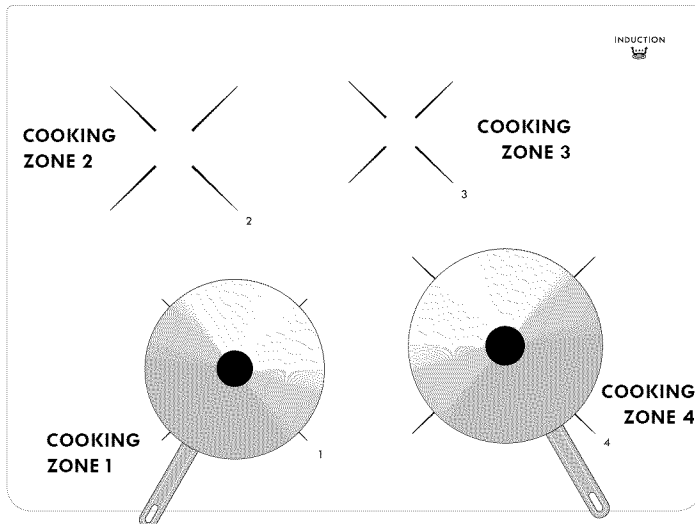

Fig. 3

## Setting Surface Controls

### Setting induction cooking zones

Start most cooking operations on a higher setting and then set to a lower setting to finish cooking. Suggested power level settings are shown in Fig. 1. The suggested settings may vary slightly depending on the pan material type and amount of food being prepared.

For induction cooking be sure to use cookware that is constructed with magnetic base material and meets the minimum and maximum pan size requirements.

**Suggested cooking zone power level settings table**

Settings	Type of cooking
Power boost (Pb)	Use to start heating pans that contain large amounts of food or bring large pans of water to boil
High (8.0-Hi)	Start most foods, bring water to a boil, pan broiling
Medium high (5.0 - 8.0)	Continue a rapid boil, fry, deep fat fry
Medium (3.0 - 5.0)	Maintain a slow boil, thicken sauces and gravies or steam vegetables
Medium low (2.0 - 3.0)	Keep foods cooking, poach, stew (2.8 or lower is a simmer setting)
Low (Lo - 2.0)	Keep warm, melt, simmer (2.8 or lower is a simmer setting)

Fig. 1

#### Important notes:

The power settings shown in Fig. 1 are based on cooking with medium sized pans with lids. Be sure to make any further setting adjustments for best surface cooking results.

**CAUTION** The induction cooking zones will not glow red when they are hot. The glass surface may be hot from residual heat transferred from the cookware and burns may occur.

**CAUTION** Do not touch hot cookware or pans directly with hands. Always use oven mitts or pot holders to protect hands from burns.

**CAUTION** Do not place flammable items such as plastic salt and pepper shakers, spoon holders or plastic wrappings on top of the range when it is in use. These items could melt or ignite if placed too close to hot cookware.

#### To operate cooking zones:

- Place induction cookware on cooking zone.
- To activate the cooking zone press and hold  for the desired cooking zone until a tone sounds.
- Set the power level. Press **Lo**, **Med** (5.0) or **Hi** once. Please note that the **Hi** selection will automatically start with **Power Boost** (Fig. 2) setting for the first ten minutes then automatically adjust to **Hi** setting (Fig. 3).

If a different setting is desired, each press of the **Lo** or **Hi** keypad will decrease or increase the displayed power level by .5 increments from 9.5 through 3.0. Simmer power levels between 3.0 and 1.2 will decrease or increase by .2 increments. **Lo** (Fig. 4) is the lowest power level setting available.

- Once cooking is complete, press .

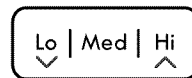

Fig. 2

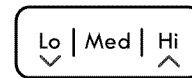

Fig. 3

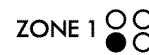

Fig. 4

#### Pan preheat recommendations

Keep in mind that induction cooking may decrease the amount of time required to preheat a cooking utensil.

When preheating a pan or cookware on the cooktop always watch very carefully. Whenever surface cooking the user should always pay attention to any cookware and the food items cooking and remain attentive until the cooking process is complete.



## Setting Surface Controls

### Setting induction zones (cont'd)

#### Important notes:

- If the cookware is moved from the center of any active induction cooking zone, the pan sensor will detect the situation and the cookware will no longer heat. The affected cooking zone display window will flash until the cookware is moved back to center of cooking zone. If the cookware is placed back properly centered on the cooking zone the cookware will resume heating. The cooking zone will remember the power level setting for up to 3 minutes before the cooking zone will automatically shut OFF.
- When initially setting the cooking zone for **Hi**, the control will automatically set for **Power Boost**. After ten minutes the Power Boost setting will then adjust to the **Hi** power level setting. If the Hi power level setting is desired press the **Lo** keypad until the **Hi** power level setting appears in display.
- The size and type of cooking utensil used, and the amount and type of food being cooked will influence the setting needed for best cooking results
- The **HE** (hot element) message may appear in the display windows and remain on after a cooking zone is turned off. The **HE** message will remain on until the cooking zones have cooled sufficiently.
- **Do not allow aluminum foil, or ANY material that can melt to make contact with the glass cooktop surface or hot cookware.** If these items melt they may damage the ceramic cooktop or cookware. Even though the cooking zones may not appear to be hot, the cookware can become very hot and residual heat will eventually transfer from the cookware to the cooktop surface.

## Home Canning

Be sure to read and observe all the following points when home canning with your appliance. Check with the USDA (United States Department of Agriculture) website and be sure to read all the information they have available as well as follow their recommendations for home canning procedures.

- Use only quality flat bottom canners when home canning. Use a straight-edge to check canner bottom.
- Use only a flat bottom canner with **no ridges** that radiate from the bottom center when home canning on a ceramic cooktop.
- **Make sure the diameter of the canner does not exceed 1/2 inch (13 mm) beyond the induction cooking zone markings.** It is recommended to **use smaller diameter canners** on ceramic glass cooktops.
- Start with hot tap water to bring water to boil more quickly.
- Use the highest heat setting when first bringing the water to a boil. Once boiling is achieved, reduce power level to lowest possible setting to maintain that boil.

#### Important note:

Never place or straddle a cooking utensil over two different cooking zones at the same time. It is important to place cookware individually centered on the cooking zones and that the pan size used meets both minimum and maximum size requirements for the cooking zone. If the pan size or placement is not correct, the pan sensor will not allow the cooking zone to activate.

## Oven Control Functions

For satisfactory use of your oven, become familiar with the various keypad functions and features of the oven.



### Oven control keypads

1. **Cooktop Lock** - Use to lockout cooktop controls.
  2. **AirGuard** - Use to freshen kitchen air during cooking.
  3. **Timer Set/Off** - Use to set or cancel Timer.
  4. **Add 1 Minute** - Use to add additional minutes to Timer.
  5. **Cook Time** - Use to enter length of cook time desired.
  6. **Delay Start** - Use with Bake, Conv Bake, Conv Convert and Flex Clean functions to program a delay start time or delay start self-cleaning cycle.
  7. **Oven Lights** - Use to turn the oven lights ON and OFF.
  8. **Clock** - Use to set the time of day.
  9. **Slow Cook** - Use to set Slow Cook function.
  10. **PreHeat** - Use to pre-condition the oven temperature.
  11. **Bake** - Use to start normal Bake function.
  12. **Warm & Hold** - Use to select Warm & Hold function.
  13. **Conv Bake** - Use to select Conv Bake function.
  14. **Conv Convert** - Use to select Conv Convert function.
  15. **Conv Roast** - Use to select Conv Roast function.
  16. **Recipe Recall** - Use to store and recall recipes.
  17. **Broil** - Use to select Broil function.
  18. **Flex Clean** - Use to set a 2 to 4 hour self-clean cycle.
  19. **START** - Use to start oven functions.
  20. **STOP** - Use to cancel any oven function previously entered except Clock and Timer.
  21. **Oven Lockout** - Use to lockout oven functions and door.
- 0-9 keypads** - Use to enter oven temperature and times.

### Minimum & maximum control settings

All of the features listed have minimum and maximum time and temperature settings that may be entered into the control. An ENTRY acceptance beep will sound each time a keypad is touched (the Oven Lockout keypad is delayed by 3 seconds).

An ENTRY ERROR tone (3 short beeps) will sound if the entry of the temperature or time is below the minimum or above the maximum settings for the feature.

Feature	Min. temp. or time	Max. temp. or time
PreHeat	170°F / 77°C	500°F / 260°C
Bake	170°F / 77°C	500°F / 260°C
Broil	400°F / 205°C	550°F / 288°C
Timer	1 Min.	11 Hrs. 59 Mins.
Flex Clean	2 hours	4 hours
Conv Bake	170°F / 77°C	500°F / 260°C
Conv Convert	170°F / 77°C	500°F / 260°C
Conv Roast	170°F / 77°C	500°F / 260°C
Slow Cook	Lo (225°F / 180°C)	Hi (275°F / 134°C)
Cook Time	1 Min.	11:59
Delay Time 12 Hr.	1:00	12:59
Delay Time 24 Hr.	0:00	23:59
Clock 12 Hr.	1:00	12:59
Clock 24 Hr.	0:00	23:59

## Setting Oven Controls



### Setting Clock

When the appliance is first powered up, 12:00 will flash in the display (See Fig. 1). The time of day must first be set before operating the oven.



Fig. 1

#### Example — To set the clock for 1:30:

1. Press  keypad.
2. Enter **1 3 0** using numeric keypads.
3. Press .

#### Important note:

The clock cannot be changed when a Cook Time, Flex Clean, Delay Start or cooking feature is active.

### Setting Timer

The minute timer allows you to track your cooking times without interfering with the cooking process. The timer may be set from 1 minute up to 11 hours and 59 minutes.

#### Example — To set the timer for 5 minutes:

1. Press **Timer Set/Off** keypad.
2. Enter **5** using numeric keypad.
3. Press  keypad to start timer.

To cancel the timer when active press **Timer Set/Off** keypad again.

#### Important notes:

- The timer does not start or stop the cooking process. It serves as an extra minute timer in the kitchen that will beep when the set time has run out. The timer may be used alone or while using any of the other oven functions.
- The timer will display hours and minutes until 1 hour remains. When less than 1 hour remains, the display will count down in minutes and seconds. Once the timer has less than 1 minute remaining only seconds will display.
- When the timer is active during a cooking process, the minute timer will show in the display. To view the information of any other active oven function, press the keypad once for the other function to view the status.

### Add 1 Minute

Use the **Add 1 Minute** keypad to set additional minutes to the timer. Each press of the keypad will add 1 additional minute. If Add 1 Minute keypad is pressed when the timer is not active, the timer will activate and begin counting down from 1 minute.

#### Example — To add 2 minutes to the timer:

Press **Add 1 Minute** keypad twice.

### Setting 12 or 24 hour display mode

The clock display mode allows you to choose between 12 or 24 hr modes. The factory pre-set clock display mode is 12 hours.

#### Example — To set 12 or 24 hour display mode:



1. Press and hold  keypad for 6 seconds.
2. Press **Flex Clean** keypad to toggle between 12 Hr day or 24 Hr day display modes (See Figs. 2 & 3).
3. Press  to accept choice.



Fig. 2



Fig. 3

### Changing between continuous bake setting or 12-Hour Energy Saving feature

The oven control has a factory preset built-in 12 Hour Energy Saving feature that will turn off the oven if the oven is left on for more than 12 hours. The control may be programmed to override this feature to continuously bake.

#### Example — To change between continuous bake or 12-Hour Energy saving feature:

1. Press and hold **Timer Set/Off** keypad for 6 seconds.
2. Press **Flex Clean** to toggle between 12 Hour OFF (Fig. 4) or Stay On (Fig. 5) feature.
3. Press  to accept choice.



Fig. 4



Fig. 5

## Setting Oven Controls

### Changing oven temperature display

The oven control is preset to display °F (Fahrenheit) when shipped from the factory. The control can be changed to display either Fahrenheit or Celsius.

#### Example — To change the temperature to display °C (Celsius) or °F (Fahrenheit):

1. Press and hold **Broil** keypad for 6 seconds.
2. Press **Flex Clean** keypad to toggle between Fahrenheit or Celsius temperature display modes (Figs. 1 & 2).
3. Press  to accept choice.

#### Important note:

The oven temperature display cannot be modified when cooking or if **Flex Clean** is active.



Fig. 1



Fig. 2

### Setting silent or audible control mode

Silent mode allows the oven control to operate without audible tones. The control may be programmed for silent operation and later returned to operating with all the normal audible tones.

#### Example — To set for silent or audible mode:

1. Press and hold **Delay Start** keypad for 6 seconds.
2. Press **Flex Clean** keypad to toggle between beep on or beep off. (See Figs. 3 & 4).
3. Press  to accept choice.



Fig. 3



Fig. 4

### Setting Oven Lockout

The control may be programmed to lock the oven door and lock the oven control keypads.



#### To activate the oven lockout feature:

1. Be sure oven door is completely closed.
2. Press and hold  for 3 seconds. **door Loc** (See Fig. 5) will appear in the display. The motor driven door latch mechanism will begin locking the oven door automatically. Do not open the oven door. Allow about 15 seconds for the oven door to completely lock. Once the oven door is locked, the **Loc** will appear in the display (See Fig. 6).



Fig. 5



Fig. 6

#### To cancel the oven lockout feature:

1. Press and hold  for 3 seconds. The motor driven door latch mechanism will begin unlocking the oven door automatically. Do not open the oven door. Allow about 15 seconds for the oven door to completely unlock.
2. When the **Loc** message (Fig. 6) no longer displays, the oven door may be opened and the oven control keypads will be available for use.

#### Important notes:

- To avoid possible damage to the oven door latching mechanism, do not attempt to open or close the oven door whenever the **doorLoc** message is displayed.
- If a control keypad is pressed when OVEN LOCKOUT is active, the control may triple beep indicating the keypad action is not available when the OVEN LOCKOUT feature is active.

## Setting Oven Controls

### Setting Preheat

For best baking performance use the **Preheat** feature. The Preheat feature will bring the oven up to the set cooking temperature. A reminder tone will sound indicating when the set temperature is reached and to place the food in the oven.

When the oven is finished preheating the preheat feature will perform like the Bake feature and continue to maintain the oven set temperature until cancelled.

Preheat may be set for any oven temperature between 170°F (77°C) to 500°F (260°C).

**⚠ CAUTION** Always use pot holders or oven mitts when using the oven. When cooking, the oven interior, oven exterior, oven racks and cooktop will become very hot which can cause burns.

**Example — To set Preheat with default oven temperature of 350°F:**

1. Press **PreHeat** keypad.
2. Press  (See Fig. 1).



To cancel preheating at anytime press .



Fig. 1

**Example — To set oven for Preheat to 450°F:**

1. Press **PreHeat** keypad.
2. Press **4 5 0** using numeric keypads.
3. Press .

To cancel preheating at anytime press .

#### Important notes:

- When setting Bake or any cooking feature that preheats the oven (except Broil), the Convection fan will turn on and stay on until the oven reaches set temperature.
- Preheating is not necessary when roasting or cooking casseroles.

### Setting Bake

Use the bake feature whenever the recipe calls for baking using normal temperatures. A reminder tone will sound indicating when the set bake temperature is reached and to place the food in the oven.

Bake may be set for any oven temperature between 170°F (77°C) to 500°F (260°C).

**⚠ CAUTION** Always use pot holders or oven mitts when using the oven. When cooking, the oven interior, oven exterior, oven racks and cooktop will become very hot which can cause burns.

**Example — To set Bake with default oven temperature of 350°F:**

1. Press **Bake** keypad.
2. Press .

To cancel bake at anytime press .

**Example — To set Bake for oven temperature of 425°F:**

1. Press **Bake** keypad.
2. Enter **4 2 5** using numeric keypads.
3. Press .

To cancel bake at anytime press .

#### Important notes:

- For optimum cooking results it is recommended to preheat the oven when baking foods such as cookies, cakes, biscuits and breads.
- When setting Bake or a cooking feature that preheats the oven (except Broil), the Convection fan will turn on and stay on until the oven reaches set temperature.
- Dark or dull pans absorb more heat than shiny bakeware resulting in dark or overbrowning of foods. It may be necessary to reduce the oven temperature or cook time to prevent overbrowning of some foods. Dark pans are recommended for pies. Shiny pans are recommended for cakes, cookies and muffins.
- The oven will bake no longer than 12 hours. If you wish to continuously bake, see **Changing between continuous bake setting or 12-Hour Energy Saving feature** for detailed information.

## Setting Oven Controls

### Setting Cook Time

Use Cook Time to program the oven control to automatically turn the oven function off after a desired length of time.

**⚠ WARNING FOOD POISONING HAZARD.** Do not let food sit for more than one hour before or after cooking. Doing so can result in food poisoning or sickness. Foods that can easily spoil such as milk, eggs, fish, meat or poultry, should be chilled in the refrigerator first. Even when chilled, they should not stand in the oven for more than 1 hour before cooking begins, and should be removed promptly when finished cooking.

**Example — To program oven to Bake with oven default temperature of 350°F and to shut-off after 30 minutes:**

1. Press **Cook Time** keypad.
2. Enter **3 0** using numeric keypads.
3. Press  to accept.
4. Press **Bake** keypad.
5. Press .



Fig. 1

#### When the programmed cook time runs out:

1. **End** will appear in the display window and the oven will shut-off automatically (See Fig. 1)
2. The oven control will provide a beep 3 times every 30 seconds as a reminder until  keypad is pressed.

#### Important notes:



- The Cook Time feature may be set with Bake, Conv Bake, Conv Roast, Slow Cook and Preheat. Cook Time or Delay Start will not operate with the Broil function.
- The maximum default Cook Time setting is 11 hours and 59 minutes.
- After the Cook Time feature has been activated, press the **Cook Time** keypad to display any cook time remaining.
- Dark or dull pans absorb more heat than shiny bakeware resulting in dark or overbrowning of foods. It may be necessary to reduce the oven temperature or cook time to prevent overbrowning of some foods. Dark pans are recommended for pies. Shiny pans are recommended for cakes, cookies and muffins.

### Setting Delay Start

Delay Start sets a delayed starting time to oven cooking or cleaning functions. Prior to setting a delay start, be sure the time of day is set correctly.

**⚠ WARNING FOOD POISONING HAZARD.** Do not let food sit for more than one hour before or after cooking. Doing so can result in food poisoning or sickness. Foods that can easily spoil such as milk, eggs, fish, meat or poultry, should be chilled in the refrigerator first. Even when chilled, they should not stand in the oven for more than 1 hour before cooking begins, and should be removed promptly when finished cooking.

**Example — To program oven for a Delay Start beginning at 5:30, to shut-off automatically after 50 minutes and for baking at 375 F:**

1. Press **Cook Time** keypad.
2. Enter **5 0** using numeric keypads.
3. Press  to accept
4. Press **Delay Start** keypad.
5. Enter **5 3 0** using numeric keypads.
6. Press  to accept.
7. Press **Bake** keypad.
8. Enter **3 7 5** using numeric keypads.
9. Press .

#### When the programmed cook time runs out:

1. **End** will appear in the display window and the oven will shut-off automatically (See Fig. 1).
2. The oven control will provide a beep 3 times every 30 seconds as a reminder until  keypad is pressed.

#### Important notes:

- Delay Start may be set using a 24 hour clock. See Setting 12 or 24 hour display modes for more information.
- The Delay Start feature may be used with the Conv Bake, Conv Roast, Conv Convert, Bake, Slow Cook and Preheat functions and Flex Clean. Delay Start or Cook Time will not operate with the Broil function.

## Setting Oven Controls

### Setting Conv Bake

#### Benefits of the convection bake feature

- Foods may cook up to 25 to 30% faster, saving time and energy.
- Multiple rack baking.
- No special pans or bakeware needed.

Convection functions use a fan to circulate the oven's heat uniformly and continuously around the oven. This improved heat distribution allows for fast, even cooking and browning results. It also gives better baking results when using two oven racks at the same time.

Heated air flows around the food from all sides, sealing in juices and flavors. Breads and pastry brown more evenly.

Most food items will cook faster and more evenly with the convection feature.

Conv Bake may be set for any oven temperature between 170°F (77°C) to 500°F (260°C).

#### Suggestions for Convection baking:

- For optimum cooking results it is recommended to preheat the oven when baking foods such as cookies, cakes, biscuits and breads.
- Reduce oven temperature 25°F from recipe's recommended oven temperature. Follow the remainder of the recipe's instructions using the minimum recommended cook time.

#### Example — To set Conv Bake with a default oven set temperature of 350°F:

1. Press **Conv Bake** keypad.
2. Press .

To cancel Conv Bake at anytime press .

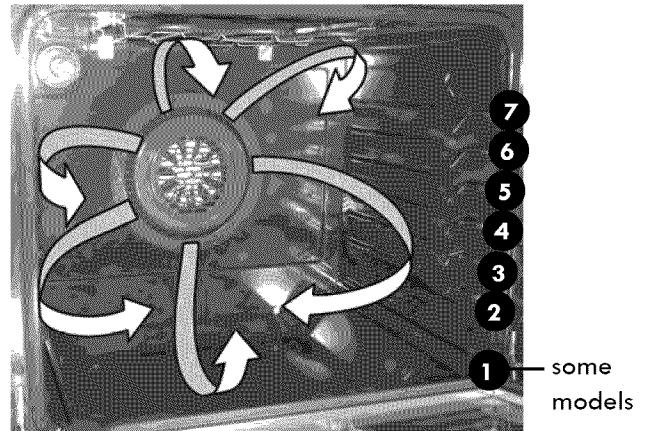

Fig. 1

#### Important notes:

- The convection fan will begin rotating once Conv Bake, Conv Roast or Conv Convert has been activated.
- If the oven door is opened when any convection function is active, the convection fan will **stop rotating** until the oven door is closed.
- When using Conv Bake cook time reductions may vary depending on the amount and type of food being cooked.
- Dark or dull pans absorb more heat than shiny bakeware resulting in dark or overbrowning of foods. It may be necessary to reduce the oven temperature or cook time to prevent overbrowning of some foods. Dark pans are recommended for pies. Shiny pans are recommended for cakes, cookies and muffins.

## Setting Oven Controls

### Setting Conv Roast

The Conv Roast function combines a cook cycle with the convection fan to roast meats and poultry. Meats cooked with Conv Roast function will be juicer and poultry will be crisp on the outside while staying tender and moist on the inside.

Conv Roast may be set for any oven temperature between 170°F (77°C) to 500°F (260°C).

#### Suggestions for Conv Roast:

- Preheating is not necessary when roasting foods using Conv Roast.
- Since Conv Roast cooks food faster, reduce the cook time by 25% from the recommended cook time of your recipe (check the food at this time). If necessary, increase cook time until the desired doneness is obtained.
- Do not cover foods when dry roasting - this will prevent the meat from browning properly.

#### Example — To set Conv Roast with a default oven set temperature of 350°F:

1. Press **Conv Roast** keypad.
2. Press .

To cancel Conv Roast at anytime press .

#### Important notes:

- The convection fan will begin rotating once Conv Bake, Conv Roast or Conv Convert has been activated.
- If the oven door is opened when any convection function is active, the convection fan will **stop rotating** until the oven door is closed.

### Setting Conv Convert

The Conv Convert function makes it easy to convert any baking recipe using the convection feature. The oven control uses the normal recipe settings and **adjusts to a lower temperature** for convection baking.

When Conv Convert is used with a Delay Start setting, the Conv Convert function will display a **CF** message (Fig. 1) as a reminder to check food when the bake time is 75% complete. At this time the oven control will sound 1 long beep at regular intervals until the set cook time has finished.





Fig. 1

#### Example — To add Conv Convert to Conv Bake function using default oven set temperature:

1. Press **Conv Bake** keypad.
2. Press **Conv Convert** keypad.

To cancel Conv Convert at anytime press .

#### Example — To program oven for Conv Convert with oven default temperature of 350°F and to shut-off after 30 minutes:

1. Press **Conv Bake** keypad.
2. Press  to accept.
3. Press **Cook Time** keypad.
4. Enter **3 0** using numeric keypads.
5. Press  to accept.
6. Press **Conv Convert** keypad.

To cancel Conv Convert at anytime press .

#### Important notes:

- Conv Convert may only be used with the **Conv Bake** function.
- When using Conv Convert function Cook Time reductions may vary depending on the oven set temperature.
- The minimum amount of Cook Time that may be entered using the Conv Convert function is 20 minutes.
- The convection fan will begin rotating once Conv Bake, Conv Roast or Conv Convert has been activated.
- If the oven door is opened when any convection function is active, the convection fan will **stop rotating** until the oven door is closed.





# Setting Oven Controls

## Setting Broil

Use the broil function to cook meats that require direct exposure to radiant heat for optimum browning results. The Broil feature is factory preset to broil at 550°F. The Broil function temperature may be set at any temperature between 400°F (205°C) and 550°F (288°C).

Be aware that the suggested broil settings table (Fig. 3) provide recommendations only. Increase or decrease broiling times, or move to a different rack position to suit for doneness. If the food you are broiling is not listed in the table, follow the instructions provided in your cookbook and watch the item closely.

### Example — To set Broil with the default broil oven temperature of 550°F:

1. Arrange the oven racks when cool. For optimum browning results, preheat oven for 5 minutes before adding food.
2. Position cookware in oven. **Leave the oven door open at the broil stop position when broiling** (See Fig. 2).
3. Press **Broil** keypad.
4. Press .
5. Broil on one side until food is browned; turn and broil on other side.
6. When finished broiling press .

To cancel Broil at anytime press .

**⚠ WARNING** Should an oven fire occur, close the oven door and turn the oven OFF. If the fire continues, use a fire extinguisher. **DO NOT** put water or flour on the fire. Flour may be explosive.

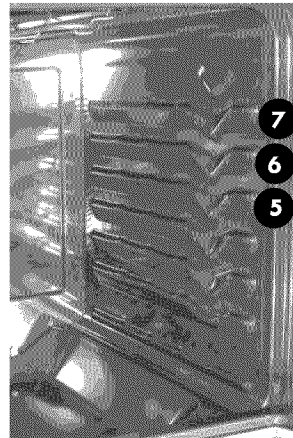

Fig. 1

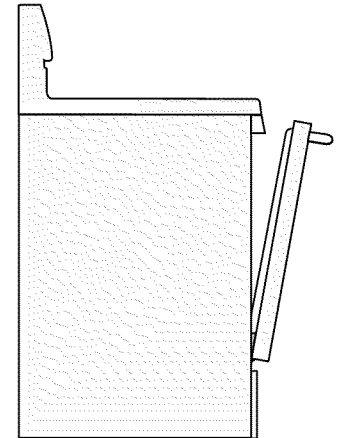

Fig. 2

**⚠ CAUTION** Always use pot holders or oven mitts when using the oven. When cooking, the oven interior, exterior, oven racks and cooktop will become very hot which can cause burns.

### Important notes:

- Always arrange oven racks when the oven is cool.
- For best results when broiling, use a quality broil pan along with a broil pan insert. A broil pan is designed to drain the fat from the food, help avoid spatter and reduce smoking.
- When broiling, always pull the oven rack out to the stop position before turning or removing food.
- Cook Time or Delay Start will not operate with the Broil function.

**Suggested broil settings table (electric oven)**

Food	Rack position (See Fig. 1)	Setting	Cook time in minutes		Doneness
			1st side	2nd side	
Steak 1" thick	6th or 7th*	550°F	6	4	Medium
Steak 1" thick	6th or 7th*	550°F	7	5	Medium-well
Steak 1" thick	6th or 7th*	550°F	8	7	Well
Pork chops 3/4" thick	6th	550°F	8	6	Well
Chicken-bone in	5th	450°F	20	10	Well
Chicken-boneless	6th	450°F	8	6	Well
Fish	6th	550°F	- as directed -		Well
Shrimp	5th	550°F	- as directed -		Well
Hamburger 1" thick	7th*	550°F	9	7	Medium
Hamburger 1" thick	6th	550°F	10	8	Well

\*Use the off-set rack only in rack position 7.

Fig. 3

## Setting Oven Controls

### Setting Slow Cook

The Slow Cook function may be used to cook foods more slowly and at lower oven temperatures. Slow Cook provides cooking results much the same way as a Slow Cooker or Crock-Pot.

Slow Cook is ideal for roasting beef, pork & poultry. Slow cooking meats may result in the exterior of meats becoming dark but not burnt. This is normal.

For Slow Cook two settings are available, high (**Hi**) or low (**Lo**). The high setting is best for cooking foods from a 4 to 5 hour time period. The low setting is best for cooking foods from a 8 to 9 hour time period.

#### Some tips for best results when using Slow Cook:

- Completely thaw all frozen foods before cooking with the Slow Cook.
- When using a single oven rack, place in oven rack position 2 or 3.
- Position multiple racks to accommodate size of cooking utensils when cooking multiple food items.
- Do not open the oven door often or leave the door open when checking foods. If the oven heat escapes often, the Slow Cook time may need to be extended.
- Cover the foods to keep them moist or use a loose or vented type cover to allow foods to turn crisp or brown.
- Roasts may be left uncovered so browning can occur. Cook times will vary; depending on the weight, fat content, bone & the shape of the roast.
- Use the recipe's recommended food temperature and a food thermometer to determine when the food is done.
- Preheating the oven will not be necessary when using the Slow Cook feature.
- Add any cream or cheese sauces during the last hour of cooking.

**⚠ WARNING FOOD POISONING HAZARD.** Do not let food sit for more than one hour before or after cooking. Doing so can result in food poisoning or sickness. Foods that can easily spoil such as milk, eggs, fish, meat or poultry, should be chilled in the refrigerator first. Even when chilled, they should not stand in the oven for more than 1 hour before cooking begins, and should be removed promptly when finished cooking.

#### Example — To set Slow Cook:

1. Position cookware in oven and close oven door.
2. Press **Slow Cook** keypad. Hi will appear in the display indicating the default temperature setting is for high.
3. If a low setting is needed, press **Slow Cook** keypad again to select the low setting.
4. Press  to activate Slow Cook.

To cancel Slow Cook at anytime press .

#### Important notes:

- Slow Cook may be used with additional settings of Cook Time and Delay Start.
- The maximum cook time for the Slow Cook is 11 hours and 59 minutes unless the control has been changed to the continuous Bake mode.

### Using AirGuard™ feature

Your appliance is equipped with a catalytic oven exhaust cleaner that may be turned on during any active oven cooking process. This feature helps remove smoke and eliminates 85% of the odors generated when using your oven.

If you wish to have this AirGuard clean the oven exhaust once cooking has started, press  keypad.

To turn AirGuard off press .

#### Important note:

The AirGuard indicator light will display when the AirGuard is active (See Fig. 1). AirGuard will turn on automatically and cannot be manually turned off when Flex Clean is active.



Fig. 1



## Setting Oven Controls

### Warm & Hold™



Warm & Hold will keep cooked foods warm for serving up to 3 hours after cooking has finished. After 3 hours the Warm & Hold will shut-off automatically. Warm & Hold should only be used with foods that are already at serving temperatures. Warm & Hold will maintain the oven temperature at 170° F (77°C).

**⚠ WARNING FOOD POISONING HAZARD.** Do not let food sit for more than one hour before or after cooking. Doing so can result in food poisoning or sickness. Foods that can easily spoil such as milk, eggs, fish, meat or poultry, should be chilled in the refrigerator first. Even when chilled, they should not stand in the oven for more than 1 hour before cooking begins, and should be removed promptly when finished cooking.

#### Example — To set Warm & Hold:

1. If needed, arrange interior oven racks and place cooked food in oven.
2. Press **Warm & Hold** keypad. **HLd** will appear in the display. If no further keypads are touched within 25 seconds the request for Warm & Hold will clear.
3. Press . Warm & Hold will automatically turn off after 3 hours.  
To turn Warm & Hold off at any time press .

#### Example — To add Warm & Hold to automatically turn ON after baking 45 minutes with default oven set temperature of 350°F:

1. Press **Cook Time** keypad.
2. Enter **4 5** using numeric keypads.
3. Press  to accept.
4. Press **Bake** keypad.
5. Press  to accept.
6. Press **Warm & Hold** keypad. **HLd** will appear in the display.
7. Press  to accept. When the cook time runs out, the Warm & Hold will turn ON automatically. Warm & Hold will automatically turn off after 3 hours.





#### Important notes:

- Warm & Hold will maintain the oven temperature at 170° F (77°C) for 3 hours.
- Warm & Hold may be set when finished cooking or may be added to automatically turn on after cooking using Cook Time. Delay Start may also be added.



### Recipe Recall

Use the **Recipe Recall** feature to record and recall your favorite **baking** recipe settings. This feature may store and recall up to three different recipe settings using the numeric keypads 1, 2 and 3. Recipe Recall may be programmed for any baking temperature between 170°F (77°C) to 500°F (260°C).

#### Example — To store a recipe setting using the number 3 keypad. Recipe in example is for bake at 325°F with a 45 minute cook time:

1. Press **Recipe Recall** keypad.
2. Press **3** keypad to store the recipe.
3. Press **3 2 5** using the numeric keypads to enter oven temperature.
4. Press .
5. Press **Cook Time** keypad.
6. Press **4 5** using numeric keypads to enter cook time.
7. Press and hold  until a tone sounds (about 3 seconds). The tone indicates that the recipe setting has been recorded for future recall.
8. Press . **Important note;** The oven will automatically start heating with the recorded recipe unless  is pressed at this time.

#### Example - to recall recipe stored in the example shown above. Recipe is for bake at 325°F for 45 minutes:

1. Position cookware in oven and close door.
2. Press **Recipe Recall** keypad.
3. Press **3** keypad to recall the stored recipe. If the recipe was stored using the 1 or 2 numeric keypads, press that keypad instead.
4. Press . The oven will begin to cook with the programmed recipe. If Cook Time was recorded this feature will also recall the cooking time.  
To cancel Recipe Recall at anytime press .

#### Important notes:

- The Recipe Recall stores **bake** recipes only. This feature will not work with Delay Start settings.
- If a recalled recipe includes Cook Time the oven will automatically shut-off when the Cook Time is finished.
- To erase all recipes stored see section for **Restoring factory default settings**.

## Setting Oven Controls

### Adjusting oven temperature

Your appliance has been factory calibrated and tested to ensure an accurate baking temperature. For the first few uses, follow your recipe times and temperature recommendations carefully. If you think the oven is cooking too hot or too cool for your recipe times, you may adjust the control so the oven cooks hotter or cooler than the oven temperature displayed.

The oven temperature may be increased as much as +35°F (+19°C) or decreased -35°F (-19°C) from the factory calibrated settings.

#### Example — To increase (+) or decrease (-) the oven temperature by 20°F:

1. Press and hold **Bake** keypad until the control provides the 2nd audible tone (about 6 seconds).
2. Enter **2 0** using numeric keypad.
3. Press **Flex Clean** keypad to toggle between plus (+) if increasing temperature or minus (-) if decreasing the temperature. These symbols will show in the display.
4. Press  to accept change.

#### Important notes:

- Oven temperature adjustments made will not change the Broil or Flex Clean function temperatures.
- If the temperature shows an adjustment of -20°F, and a +20°F adjustment is needed, you can toggle between the minus (-) or plus (+) in the display when pressing **Flex Clean** keypad (See step 3).
- **DO NOT USE** oven thermometers such as those found in grocery stores to check the temperature settings inside your oven. These oven thermometers may vary as much as 20 to 40°F degrees from actual temperatures.
- The oven temperature adjustment may be made if your oven control has been set to display °C (Celsius) temperatures. Minimum and maximum settings for Celsius is plus (+) or minus (-) 19°C.

### Restoring factory default settings

When new, your appliance left the factory with predetermined oven control settings. Over time, the user may make changes to these default settings. The following options have user settings that may be modified and may have been set with changes since the appliance was new:

- 12 or 24 hour display mode
- Continuous bake or 12-Hour Energy Savings mode
- Silent or audible control
- Oven temperature display (Fahrenheit or Celsius)
- Oven temperature adjustments
- Stored recipes

Please remember that if you choose to restore to factory default settings, **ALL** of the above user settings will be restored to factory default settings, the oven temperature offset will reset and any stored recipe information will be cleared.

#### Example — To restore oven control to factory default settings:

1. Press and hold **7** keypad until acceptance tone sounds (about 6 seconds).
2. Press . The control has been reset with default settings.

### Operating oven lights

The interior oven lights will automatically turn ON when the oven door is opened.

Press  to turn the interior oven lights ON and OFF whenever the oven door is closed.

The interior oven lights are located on the rear wall of the oven interior and are covered with a glass shield. The glass shield protects the bulb from high temperatures and should always be in place whenever the oven is in use.

To replace the interior oven light, see **Replacing oven lights** in the Care & Cleaning section.

## Setting Oven Controls

### Setting the Sabbath feature (for use on the Jewish Sabbath & Holidays)



For further assistance, guidelines for proper usage and a complete list of models with the Sabbath feature, please visit the web at <http://www.star-k.org>.

The **Cook Time** and **Delay Start** keypads are used to set the Sabbath feature. The Sabbath feature may only be used after the **Bake** function is active.

Once the oven is properly set using the **Bake** function and the Sabbath mode is active, the oven will remain continuously ON until the Sabbath feature is cancelled. The Sabbath feature will override the factory preset 12-Hour Energy Saving feature and start the continuous bake mode.

**⚠ WARNING FOOD POISONING HAZARD.** Do not let food sit for more than one hour before or after cooking. Doing so can result in food poisoning or sickness. Foods that can easily spoil such as milk, eggs, fish, meat or poultry, should be chilled in the refrigerator first. Even when chilled, they should not stand in the oven for more than 1 hour before cooking begins, and should be removed promptly when finished cooking.

**Example — To program oven to Bake with default oven temperature of 350°F and activate the Sabbath feature:**







1. Be sure the clock is set with the correct time of day.
2. Arrange oven racks, place cookware in oven and close oven door.
3. Press **Bake** keypad.
4. Press .
5. If Cook Time or Delay Start are not needed, **skip this step and continue to step 6.** If a Cook Time or Delay Start are desired enter the times at this point. Refer to the Cook Time and Delay Start sections for detailed instructions.
6. Press and hold both **Cook Time** and **Delay Start** keypads simultaneously for about 3 seconds to set the Sabbath feature. Once the feature is set, **SAb** (Fig. 1) will appear in the display indicating the oven is properly set for the Sabbath feature.



Fig. 1

#### Important notes:

- It is not advised to attempt to activate any other oven function except Bake while the Sabbath feature is active. ONLY the following keypads will function correctly when the Sabbath feature is active: **0-9** number keypads, **Bake**,  and . ALL OTHER KEYPADS should not be used once the Sabbath feature is active.
- You may change the oven temperature once baking has started. Press **Bake** keypad, use the numeric keypads to enter the oven temperature change (170 to 500°F) and press  (for Jewish Holidays only). Remember that the oven control will no longer provide audible tones or display any further changes when the Sabbath feature is active.
- It is recommended that any oven temperature change with the Sabbath feature active be followed with two presses of the  keypad. This will insure the oven remains ON even if the attempt to set the oven temperature was lower or higher than the oven control can accept. If the oven temperature is set incorrectly, the oven temperature will default to 170°F or 500°F. Try to set the desired oven temperature again.
- If the oven light is needed during the Sabbath, press the  keypad to turn oven light on **before** activating the Sabbath feature. Once the oven light is turned ON and the Sabbath feature is active, the oven light will remain on until the Sabbath feature is turned OFF. If the oven light needs to be off, be sure to turn the oven light off **before** activating the Sabbath feature.
- Remember the oven will shut-off automatically after completing a **Cook Time**, **Delay Start** or **Warm & Hold** and therefore may only be used once during the Sabbath/Jewish Holidays.
- If a Delay Start time longer than the default 11 hours and 59 minutes is desired, set the oven control for the 24 hour day display mode setting. For detailed instructions see **Setting 12 or 24 hour display modes**.
- The **Cooktop Lock** will automatically lock the cooktop when the Sabbath feature is active. The induction cooking zones will not be available until the Sabbath feature is cancelled.

## Setting Oven Controls

### Sabbath Feature (for use on the Jewish Sabbath & Holidays)

**Example - to turn the oven off and keep the Sabbath feature active:**

Press .

**Example - to turn off the Sabbath feature:**

Press and hold both **Cook Time** and **Delay Start** key pads simultaneously for at least 3 seconds to turn the Sabbath feature off. The control will provide an acceptance tone and **SAb** will disappear from the display. The oven is no longer programmed for the Sabbath feature.

**What to do during a power failure or power interruption after the Sabbath feature was activated:**

Should you experience a power failure or interruption, the oven will shut-off. When power is restored the oven will not turn back on automatically. The oven will remember that it is set for the Sabbath and the oven display will show the message **SF** for Sabbath failure (Fig. 1).

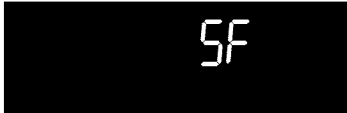

Fig. 1

The food may be safely removed from the oven while still in the Sabbath feature, however the oven cannot be turned back on until after the Sabbath/Holidays. After the Sabbath observance turn OFF the Sabbath feature. Press and hold both **Cook Time** and **Delay Start** keypads for at least 3 seconds simultaneously to turn the Sabbath feature off. **SF** will disappear from the display and the oven may be used with all normal functions.

## Warmer Drawer

### Warm & Ready™ drawer (some models)

The purpose of the warmer drawer is to keep hot cooked foods at serving temperatures. Examples are vegetables, gravies, meats, casseroles, biscuits, rolls and pastries. It is not recommended to heat cold food in the warmer drawer; always start with hot food.

The warmer drawer may also be used to warm dinner plates. All food placed in the warmer drawer should be covered with a lid or aluminum foil to maintain quality.

**⚠ WARNING FOOD POISONING HAZARD.** Do not let food sit for more than one hour before or after cooking. Doing so can result in food poisoning or sickness. Foods that can easily spoil such as milk, eggs, fish, meat or poultry, should be chilled in the refrigerator first. Even when chilled, they should not stand in the oven for more than 1 hour before cooking begins, and should be removed promptly when finished cooking.

**⚠ WARNING Storage in or on appliance—flammable materials should not be stored in an oven, warmer drawer, near surface units.** This includes paper, plastic and cloth items, such as cookbooks, plasticware and towels, as well as flammable liquids. Do not store explosives, such as aerosol cans, on or near the range.

**⚠ WARNING DO NOT LEAVE CHILDREN ALONE — children should not be left alone or unattended in the area where appliance is in use.** They should never be allowed to sit or stand on any part of the appliance, including the warmer drawer.

**⚠ CAUTION** Always use potholders or oven mitts when removing food from the warmer drawer as cookware and plates will be hot and you can be burned.

#### Important note:

The warmer drawer is equipped with a catch that may require extra force to open and close the drawer.

### Arranging warmer drawer rack positions

The keep warmer drawer rack may be used in 2 ways:

- In the **upright position** (See Fig. 1) to allow low profile food items to be placed both under and on top of the rack (for example, rolls or biscuits on top of the rack and a casserole dish underneath).
- In the **downward position** (See Fig. 2) to allow for light weight food items and empty cookware (for example, rolls or pastries and dinner plates) on the rack.

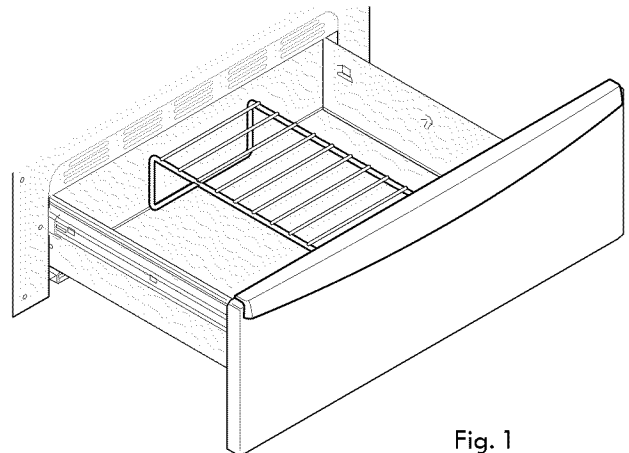

Fig. 1

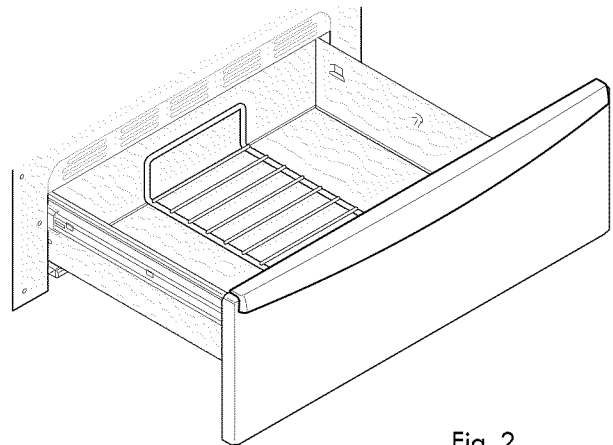

Fig. 2

# Warmer Drawer

## Warmer drawer controls

The warmer drawer controls are located on the left side of the control panel. Use the warmer drawer control keypads to turn ON and OFF and make temperature adjustments. Available temperature settings are approximate, and are designated by **Lo**, **Med**, and **Hi** (See Fig. 2). If needed, refer to **Warmer drawer recommended food settings** provided in this section.

### Warmer drawer indicator light

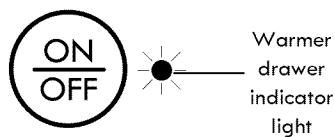

The warmer drawer indicator light is located beside the **ON-OFF** keypad (See Fig. 1). It glows when the warmer drawer is turned ON, and remains on until the warmer drawer is turned OFF.



## Warmer Drawer

Fig. 1

### To set warmer drawer:

1. Arrange the warmer drawer rack (if needed) in the warmer drawer and place the cooked food or dishes in the warmer drawer. Close warmer drawer.
2. Press .
3. Press **Temp** keypad to toggle to the desired temperature setting. Release keypad when the desired temperature setting is displayed by the indicator lights. (**Hi**, **Med**, or **Lo** - See Fig. 2).
4. Once warming is finished, press  to turn OFF and carefully remove items from warmer drawer.

**CAUTION** Always use potholders or oven mitts when removing food from the warmer drawer as cookware and plates will be hot and you can be burned.

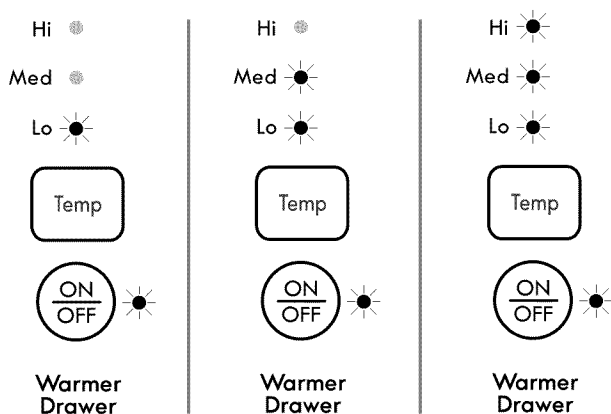

Fig. 2

## Warmer drawer settings

The recommended warmer drawer food settings are shown in Fig. 3. Remember the settings provided are meant to be used as a recommendation only. If a particular food item is not listed, start with the **Med** setting. If more crispness is desired, remove the lid or aluminum foil from the food.

Most foods may be maintained at serving temperatures on the **Med** setting. When a combination of foods are to be kept warm (for example, a meat with 2 vegetables and rolls) use the **Hi** setting. To minimize heat loss, avoid opening the warmer drawer frequently while in use.

### Warmer drawer recommended food settings

Food Item	Setting
Bacon	Hi
Hamburger patties	Hi
Poultry	Hi
Pork chops	Hi
Fried foods	Hi
Pizza	Hi
Gravies	Med
Casseroles	Med
Eggs	Med
Roasts (beef, pork or lamb)	Med
Vegetables	Med
Biscuits	Med
Rolls (hard)	Med
Pastries	Med
Rolls (soft)	Lo
Empty dinner plates	Lo

Fig. 3

### Important notes:

- **Do not use plastic wrap to cover food.** Plastic may melt onto the drawer and be very difficult to clean up. Use only utensils and cookware recommended by the manufacturer for use a warmer drawer.
- Always start with hot food when using the warmer drawer. **DO NOT** heat cold food in the warmer drawer.
- Flex Clean can not be set when the warmer drawer is active.



## Flex Clean

A self-cleaning oven cleans itself with high temperatures that are well above normal cooking temperatures. The high cleaning temperature eliminates soils completely or reduces them to a fine powdered ash you can wipe away afterwards with a damp cloth.

The Flex Clean function allows you to set any amount of cleaning time from 2 hours to 4 hours. A 3-hour cleaning time is best used for normal cleaning; 2-hour time for light soils and a 4-hour clean time for heavier stubborn soils.

### Read before starting Flex Clean

Be sure to read all the following caution and important statements **BEFORE** starting a self-clean cycle:

**⚠ CAUTION** DO NOT leave small children unattended near the appliance. During the self-cleaning cycle, the outside of the range can become very hot to touch and can cause burns.

**⚠ CAUTION** DO NOT line the oven walls, racks, bottom or any other part of the range with aluminum foil. Doing so will destroy heat distribution, produce poor baking results and cause permanent damage to the oven interior. Aluminum foil will melt to the interior of the oven.

**⚠ CAUTION** The health of some birds is extremely sensitive to the fumes given off during the self-cleaning cycle of any range. Move birds to another well-ventilated room.

**⚠ CAUTION** DO NOT force the oven door open. This can damage the automatic door locking system.

**⚠ CAUTION** Use caution when opening the oven door after self-cleaning. **The oven may still be VERY HOT** and can cause burns. To avoid possible burns stand to the side of the oven when opening the oven door to allow hot air or steam to escape.

#### Important notes:

- Completely remove **ALL OVEN RACKS** and **ANY ACCESSORIES FROM OVEN CAVITY** to avoid damage to oven racks. If the oven racks are not removed they may discolor.
- Remove ALL items from the oven and cooktop including cookware, utensils and **ANY ALUMINUM FOIL**. Aluminum foil will not withstand high temperatures from a self-clean cycle and will melt.
- **DO NOT** use oven cleaners or oven protective coatings in or around any part of the oven interior.
- Clean any soil from the oven frame, the door liner outside the oven door gasket and the small area at the front center of the oven bottom (See Fig. 1). These areas heat sufficiently to burn soil on. Clean using soap and water prior to starting Flex Clean (See Fig. 1).

- Remove any excessive spillovers. Any spills on the oven bottom should be wiped-up and removed before starting a self-clean cycle. To clean, use hot, soapy water and a cloth. Large spillovers can cause heavy smoke or fire when subjected to high temperatures. **DO NOT** allow food spills with a high sugar or acid content (such as milk, tomatoes, sauerkraut, fruit juices or pie filling) to remain on the surface as they may leave a dull spot even after cleaning.
- **DO NOT** clean the oven door gasket (See Fig. 1). The woven material of the oven door gasket is essential for a good seal. Care should be taken not to rub, damage or remove the gasket. **DO NOT** use any cleaning materials on the oven door gasket. Doing so could cause damage to the door gasket.

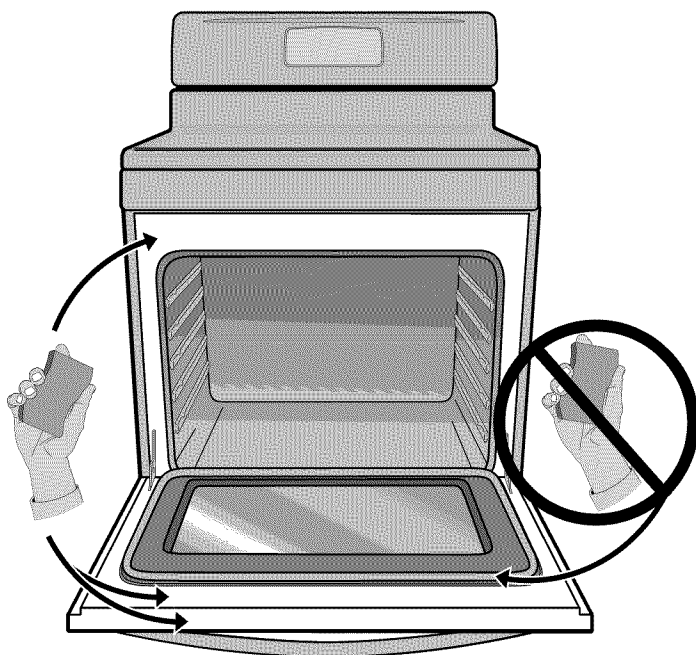

Fig. 1

### Setting Flex Clean

**Example — To set Flex Clean to start immediately:**

1. Be sure the oven is empty and **ALL** oven racks are removed. Remove all items from the cooktop. Be sure oven door is **completely** closed.
2. Press **Flex Clean** keypad for a default 3-hour clean time. After pressing Flex Clean you may accept the default 3-hour clean time by going to step 3.

At this time you may choose a different clean time. The amount of clean time must be within 2 to 4 hours and entered using the numeric keys pads. For example enter **2 0 0** for a 2-hour time or enter **4 0 0** for a 4-hour self-clean time. You may choose a 2 hour 15 minute clean time by entering **2 1 5** (hours and minutes).

3. Press  to activate Flex Clean.

## Flex Clean

### Setting Flex Clean (cont'd)

As soon as Flex Clean becomes active, a motor driven lock mechanism will begin locking the oven door automatically. **door Loc** will appear in the display (See Fig. 1). **DO NOT** open the oven door when **door Loc** is displayed (allow 15 seconds for the lock mechanism to lock the oven).

Once the oven door has locked, **CLn** will appear in the display indicating Flex Clean has started (Fig. 2).



Fig. 1



Fig. 2



Fig. 3



Fig. 4

#### When Flex Clean is finished:

1. **CLn** message will turn off and **Hot** will appear in display window (See Fig. 3).
2. Once the oven has cooled down (about 1 hour) and **Hot** is no longer displayed the **door OPn** message will appear (Fig. 4). **When this message turns off the oven door may be opened.**

**⚠ CAUTION** Use caution when opening the oven door after self-cleaning. The oven may still be **VERY HOT and can cause burns**. To avoid possible burns stand to the side of the oven when opening the oven door to allow hot air or steam to escape.



3. When the oven interior has completely cooled, wipe away any residue or powdered ash with a damp cloth or paper towel.

#### Important notes:

- The kitchen area should be well ventilated using an open window, ventilation fan or exhaust hood during the 1st self-clean cycle to help eliminate the normal odors associated with the 1st self-clean cycle.
- When the clean time finishes the oven door will remain locked until the range has cooled sufficiently. In addition to the clean time that was programmed, you must allow about 1 additional hour for the oven to cool before you will be able to open the oven door.
- The Flex Clean function will not operate whenever a radiant surface element is ON or the oven lockout is active.

### Setting Delay Start Flex Clean

**Example — To start a delay Flex Clean with default clean time of 3 hours and a start time of 9:00 o'clock:**

1. Be sure the clock is set with the correct time of day, the oven is empty and ALL oven racks are removed. Be sure oven door is completely closed.
2. Press **Delay Start** keypad.
3. Using numeric keypad enter **9 0 0** for time to start.
4. Press  to accept.
5. Press **Flex Clean** keypad.
6. Press .

#### If it becomes necessary to stop Flex Clean when active:

1. Press .
2. If Flex Clean has heated the oven to a high temperature, allow enough time for the oven to cool and for the **door OPn** message to appear (Fig. 4). When this message turns OFF the oven door may be opened.
3. Before restarting Flex Clean, be sure to read important notes below.

#### Important notes:

- When Flex Clean function is active you may check the amount of clean time remaining by pressing the Flex Clean keypad once.
- If your control is set with the default 12 hour display mode, the Delay Flex Clean can only be set to start up to 11 hours and 59 minutes in advance. To set a Delay Start Flex Clean to begin 12 or more hours (maximum is 23 hours and 59 minutes) in advance, be sure to set the control for 24 hour display mode.
- If Flex Clean was active and then interrupted by a power failure or cancelled before the oven was thoroughly cleaned, it may be necessary to run another self-clean cycle again. If the oven temperature was high enough when interrupted your oven control may not allow another self-clean cycle to be set for up to 4 hours after the interruption.

## Care & Cleaning

### Cleaning recommendation table

Surface type	Recommendation
<b>Control knobs</b> <b>Painted body parts</b> <b>Painted decorative trim</b> <b>Aluminum, plastic or vinyl trim</b>	For general cleaning, use hot, soapy water and a cloth. For more difficult soils and built-up grease, apply a liquid detergent directly onto the soil. Leave on soil for 30-60 minutes. Rinse with a damp cloth and dry. <b>Do not</b> use abrasive cleaners on any of these materials; they can scratch. To remove control knobs, turn to OFF position; grasp firmly and pull straight off the shaft. To replace knobs after cleaning, line up the flat sides of both knob and shaft; then push knob into place.
<b>Control panel</b> <b>Control keypad membrane</b> <b>Decorative trim</b>	Before cleaning the control panel, turn all controls OFF, activate oven lockout (on some models) and if needed remove any knobs from panel. <b>Do not</b> use abrasive cleaners on any of these materials; they can scratch. Clean using hot, soapy water and a dishcloth. Be sure to squeeze excess water from dishcloth before wiping control panel; especially when wiping around the controls area. Excess water in or around the controls may cause damage to the appliance. When rinsing, use clean water and a dishcloth and be sure to squeeze excess water from dishcloth before wiping the control panel.
<b>Porcelain enamel parts</b>	Gentle scrubbing with a soapy no-scratch cleaning pad will remove most spots. Rinse with a 1:1 solution of clear water and ammonia. If necessary, cover difficult spots with an ammonia-soaked paper towel for 30 to 40 minutes. Rinse with clean water and a damp cloth, and then scrub with a soap-filled no-scratch cleaning pad. Rinse and wipe dry with a clean cloth. Do not allow food spills with high sugar or acid content (milk, tomatoes, sauerkraut, fruit juices or pie filling) to remain on the surface; they may cause a dull spot even after cleaning.
<b>Oven interior</b>	For oven interior remove excessive spillovers from oven cavity bottom before starting Flex Clean. Clean any soils from oven frame and door liner outside the oven door gasket. For very important cleaning precautions be sure to read all the instructions in the Flex Clean section.
<b>Oven racks</b>	Remove oven racks from oven cavity before starting Flex Clean. Clean by using a mild, abrasive cleaner following manufacturer's instructions. Rinse with clean water, dry and then replace in oven.
<b>Oven door</b>	Use soap & water to thoroughly clean the top, sides and front of the oven door. Rinse well. You may use a glass cleaner on the outside glass of the oven door. <b>Do not</b> immerse the door in water. <b>Do not</b> spray or allow water or the glass cleaner to enter the door vents. <b>Do not</b> use oven cleaners, cleaning powders or any harsh abrasive cleaning materials on the outside of the oven door.
<b>Ceramic cooktop</b>	Do not use spray oven cleaners on the cooktop. See "Cooktop cleaning" and "Cooktop maintenance" later in the Care & Cleaning section.
<b>Stainless Steel</b> (some models)	Only use cleaners and polishes that are specifically manufactured for cleaning stainless steel. Always rub in direction of metal grain to avoid damaging. <b>Do not use cleaners with high concentrations of chlorides or chlorine.</b> <b>Do not</b> use harsh scrubbing cleaners. Polish with a lint-free cloth. Always be sure to wipe excess cleaner/polish off from the metal surface as bluish stains may occur during future oven heating that cannot be removed. Clean heavier soils with hot, soapy water and a dishcloth. Rinse and dry using clean water and a cloth.

## Care & Cleaning

### Cooktop maintenance

Consistent and proper cleaning is essential to maintaining your ceramic glass cooktop.

Prior to using your cooktop for the first time, apply the recommended CookTop® Cleaning Creme to the ceramic surface (on the web visit [www.sears.com](http://www.sears.com) for replacement cooktop cleaner, item number 40079). Buff with a non-abrasive cloth or no-scratch cleaning pad. This will make cleaning easier when soiled from cooking. The special cooktop cleaning cream leaves a protective finish on the glass to help prevent scratches and abrasions.

Sliding aluminum or copper clad bottom pans on the cooktop can cause metal markings on the cooktop surface. These marks should be removed immediately after the cooktop has cooled using the cooktop cleaning cream. Metal marks can become permanent if not removed prior to future use.

Cookware (cast iron, metal, ceramic or glass) with rough bottoms can mark or scratch the cooktop surface.

#### Do not:

- Use cookware with dirt or dirt build up on bottom; replace with clean cookware before using.
- Use your cooktop as a cutting board or work surface in the kitchen.
- Cook foods directly on the cooktop surface without a pan.
- Drop heavy or hard objects on the ceramic glass cooktop, they may cause it to crack.
- Slide anything metal or glass across the cooktop.

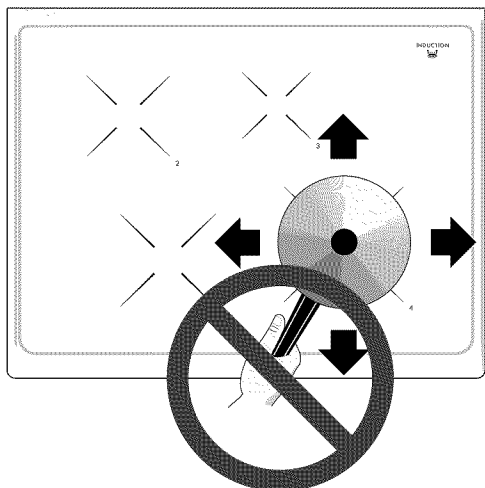

### Cooktop cleaning

**⚠ WARNING** DO NOT use a cooktop cleaner on a hot cooktop. The fumes can be hazardous to your health, and can chemically damage the ceramic-glass surface.

**⚠ CAUTION** Before cleaning the cooktop, be sure the controls are turned to OFF and the cooktop is COOL. The glass surface could be hot and burns may occur if the glass surface is touched before it has cooled sufficiently.

#### For light to moderate soil:

Apply a few drops of CookTop® Cleaning Creme directly to the cooktop. Use a paper towel or use a non-abrasive plastic type no-scratch cleaning pad to clean the entire cooktop surface. Make sure the cooktop is cleaned thoroughly, leaving no residue.

#### For heavy, burned on soil:

Apply a few drops of CookTop® Cleaning Creme directly to the soiled area. Rub the soiled area using a non-abrasive plastic type no-scratch cleaning pad, applying pressure as needed. Do not use the pad you use to clean the cooktop for any other purpose.

If soils remain, carefully scrape soils with a metal razor blade scraper, holding scraper at a 30 degree angle to the surface. Remove loosened soils with cooktop cleaning cream and buff surface clean.

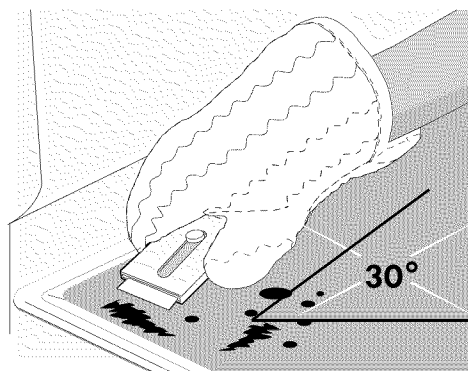

#### Plastic or foods with a high sugar content:

These types of soils need be removed immediately if spilled or melted onto the ceramic cooktop surface. Permanent damage (such as pitting of the cooktop surface) may occur if not removed immediately. After turning the surface elements OFF, use a razor blade scraper or a metal spatula with a mitt and scrape the soil from the hot surface (as illustrated). Allow the cooktop to cool, and use the same method for heavy or burned on soils.

## Care & Cleaning

### Cooktop cleaning (cont'd)

Do not use the following on the cooktop:

- Do not use abrasive cleaners and scouring pads, such as metal and some nylon pads. They may scratch the cooktop, making it more difficult to clean.
- Do not use harsh cleaners, such as chlorine bleach, ammonia or oven cleaners, as they may etch or discolor the cooktop.
- Do not use dirty sponges, cloths or paper towels, as they can leave soil or lint on the cooktop which can burn and cause discoloration.

#### Important note:

Damage to the ceramic glass cooktop may occur if you use an abrasive type cleaning pad. Only use cleaning products that have been specifically designed for ceramic glass cooktops.



### General cleaning

Refer to the **Cleaning recommendation table** in the Care & Cleaning section for more detailed information about cleaning specific parts of the range.

**⚠ CAUTION** Before manually cleaning any part of the range, be sure all controls are turned OFF and the range is COOL. The range may be hot and can cause burns.

**⚠ CAUTION** Ammonia must be rinsed before operating the oven. Provide adequate ventilation.

### Aluminum foil and utensils

**⚠ WARNING** NEVER cover any slots, holes or passages in the oven bottom or cover an entire oven rack with materials such as aluminum foil. Aluminum foil linings may trap heat, causing a fire hazard.

**⚠ WARNING** Protective Liners — DO NOT USE ALUMINUM FOIL to line the oven bottom. Only use aluminum foil as recommended in this manual. Improper installation of these liners may result in risk of electric shock, or fire.

Aluminum foil - Use of aluminum foil on a hot cooktop can damage the cooktop. Do not use thin aluminum cooking utensils or allow aluminum foil to touch the surface elements under ANY circumstances.

### Replacing interior oven lights

**⚠ CAUTION** Be sure the range is unplugged and all parts are COOL before replacing oven light. Wear a leather-faced glove for protection against possible broken glass.

#### Replacing the oven interior light bulb:

1. Turn electrical power off at the main source or unplug the appliance.
2. Remove interior oven light shield (See Fig. 1).
3. Replace bulb with a new **T-4 type 40 Watt halogen** appliance bulb. Do not allow your fingers to touch the halogen bulb when replacing. This will shorten the life of the new bulb. Use a paper towel to cover the new bulb when installing.
4. Replace glass interior oven light shield.
5. Turn power back on again at the main source (or plug the appliance back in).
6. Be sure to reset the time of day on the clock.

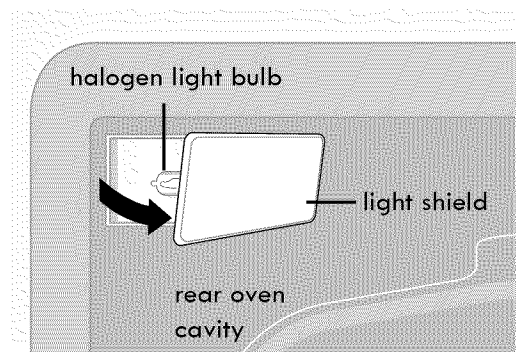

Fig. 1

## Care & Cleaning

### Removing and replacing the lift-off oven door

**⚠ CAUTION** To avoid possible injury when removing or replacing the oven door, follow the instructions below **carefully** and always hold the oven door with both hands positioned **away from the door hinge area**.

**⚠ CAUTION** The door is heavy. For safe, temporary storage, lay the door flat with the inside of the door facing down.

#### To remove oven door:

1. Open oven door completely (horizontal with floor - Fig.1).
2. Pull the door hinge locks on both left and right door hinges down from the oven frame completely towards the oven door (Fig. 2). A tool such as a small flat-blade screwdriver may be required.
3. Firmly grasp both sides of oven door along the door sides (Do not use the oven door handle - Fig. 3).
4. Close the door to the broil stop position (the oven door will stop into this position just before fully closing).
5. With the oven door in the broil stop position, lift the oven door hinge arms over the roller pins located on each side of the oven frame (Fig. 4).

#### To replace oven door:

1. Firmly grasp both sides of oven door along the door sides (Do not use the oven door handle - Fig. 3).
2. Holding the oven door at the same angle as the removal position, seat the hook of the hinge arm over the roller pins located on each side of the oven door frame (Fig. 4). The hook of the hinge arms must be fully seated onto the roller pins.
3. Fully open the oven door (horizontal with floor - Fig. 1).
4. Push the door hinge locks up towards and into the oven frame on both left and right oven door hinges (Fig. 2) to the locked position; then close the oven door.

### Special door care instructions

**Most oven doors contain glass that can break. Read the following recommendations:**

- Do not close the oven door until all the oven racks are fully in place inside the oven cavity.
- Do not hit the glass with pots, pans, or any other object.
- Scratching, hitting, jarring or stressing the glass may weaken its structure causing an increased risk of breakage at a later time.

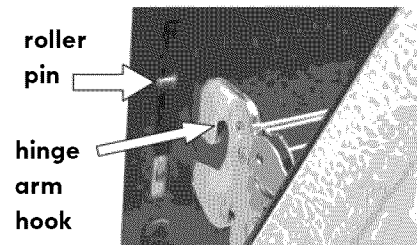
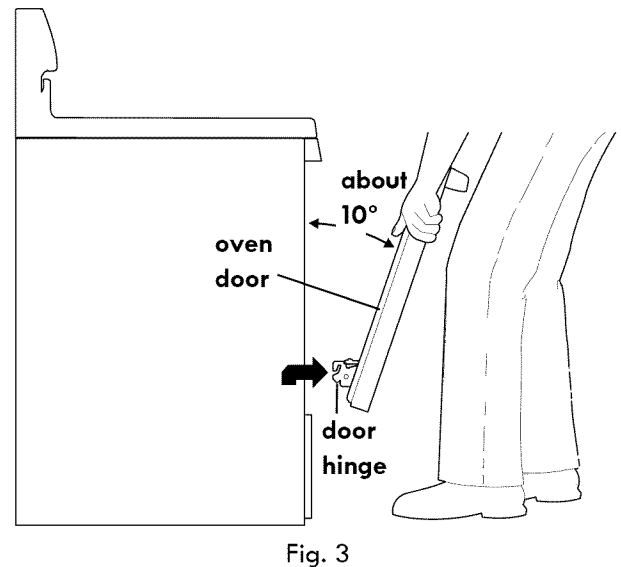
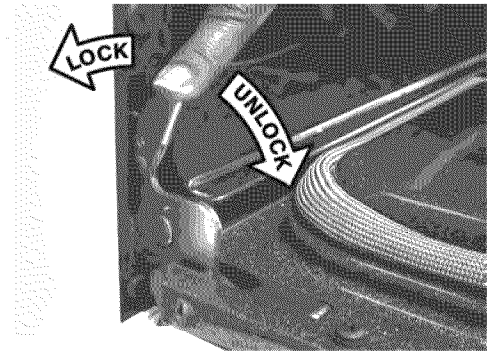
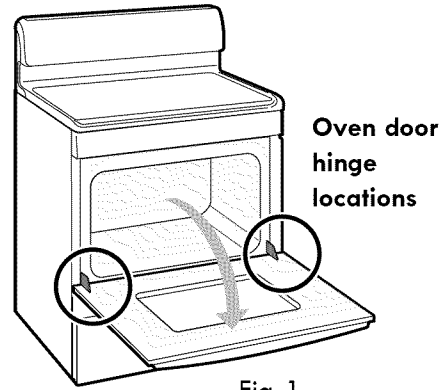



## Before You Call • Solutions to common problems

Before you call for service, review the following list. It may save you time & expense. Possible solutions to these problems are provided with the problem listed:

Problem	Solution
Poor baking results.	<ul style="list-style-type: none"><li>• Many factors affect baking results. Make sure the proper oven rack position is used. Center food in the oven and space pans to allow air to circulate. Allow the oven to preheat to the set temperature before placing food in the oven. Try adjusting the recipe's recommended temperature or baking time. If you feel the oven is too hot or cool, see <b>Adjusting oven temperature</b> in <b>Setting Oven Controls</b> section.</li></ul>
Appliance is not level.	<ul style="list-style-type: none"><li>• Be sure floor is level, strong &amp; stable enough to adequately support range.</li><li>• If floor is sagging or sloping, contact a carpenter to correct the situation.</li><li>• Poor installation. Place oven rack in center of oven. Place a level on the oven rack. Adjust leveling legs at base of appliance until the rack is level.</li><li>• Kitchen cabinet alignment may make range appear not level. Be sure cabinets are square &amp; have sufficient room for appliance clearance.</li></ul>
Cannot move appliance easily. Appliance must be accessible for service.	<ul style="list-style-type: none"><li>• Cabinets not square or are built in too tightly. Contact builder or installer to make appliance accessible.</li><li>• Carpet interferes with appliance. Provide sufficient space so appliance can be lifted over carpet.</li></ul>
Entire appliance does not operate.	<ul style="list-style-type: none"><li>• Make sure power cord is plugged properly into outlet.</li><li>• Electrical power outage. Check house lights to be sure. Call your local electric company for service outage information.</li><li>• Service wiring is not complete. Call 1-800-4-MY-HOME® for assistance (See back cover).</li></ul>
Oven portion of appliance does not operate.	<ul style="list-style-type: none"><li>• The time of day is not set. The time of day must first be set in order to operate the oven. See <b>Setting clock</b> in <b>Setting Oven Controls</b> section.</li><li>• Be sure the oven controls are set properly for the desired function. See <b>Setting Oven Controls</b> section and review instructions for the desired cooking function in this manual or see "Entire appliance does not operate" in this checklist.</li></ul>
Surface element is too hot or not hot enough.	<ul style="list-style-type: none"><li>• Incorrect surface control setting. Adjust power level setting.</li></ul>
Surface element or induction cooking zone does not heat or does not heat evenly.	<ul style="list-style-type: none"><li>• Be sure the correct surface control is turned ON for the element or cooking zone.</li><li>• <b>Induction cooking only</b> - Make sure to use the correct cookware material type on cooking zones. Use cookware specifically identified by the manufacturer to use for induction cooking. If you're not sure, use a magnet to test whether the cookware type will work. If a magnet sticks to the bottom of the cookware, the material type is correct for induction cooking. Be sure to read about pan-sensing in the <b>Induction Cooking</b> section and correct any pan-sensing issues in the checklist provided.</li></ul>
Oven light does not work.	<ul style="list-style-type: none"><li>• Be sure the oven light is secure in the socket. Also see <b>Replacing oven light</b> in the <b>Care &amp; Cleaning</b> section.</li></ul>

## Before You Call • Solutions to common problems

Problem	Solution
Cooking zones do not glow when heating.	<ul style="list-style-type: none"><li>• The induction cooking zones will not glow when they are hot. Induction cooking uses electromagnetic energy to induce heat directly to the cookware.</li></ul>
Oven smokes excessively when broiling.	<ul style="list-style-type: none"><li>• Incorrect setting. Follow broiling instructions in Setting Oven Controls section.</li><li>• Be sure oven door is opened to broil stop position when broiling.</li><li>• Meat too close to the broil element. Reposition the broil rack to provide proper clearance between the meat &amp; the element. Preheat the broil element for searing.</li><li>• Meat not properly prepared. Remove excess fat from meat. Cut remaining fatty edges to prevent curling, but do not cut into lean.</li><li>• Grease has built up on oven surfaces. Regular cleaning is necessary when broiling frequently. Old grease or food spatters cause excessive smoking.</li></ul>
Flames inside oven or smoking from oven vent.	<ul style="list-style-type: none"><li>• Excessive spillovers in oven. For example this will happen for pie spillovers or large amounts of grease left on the oven bottom. Wipe up excessive spillovers before starting oven. If flames or excessive smoke are present see <b>Broil</b> in Setting Oven Controls section.</li></ul>
Oven control panel beeps & displays any F or E code error.	<ul style="list-style-type: none"><li>• Oven control has detected a fault or error condition. Press  keypad to clear the error code. Try Bake or Broil function. If the F or E code error repeats, remove power from appliance, wait 5 minutes and then repower appliance and set clock with the correct time of day. Try Bake or Broil function again. If the fault recurs, press  to clear and call 1-800-4-MY-HOME® for assistance (See back cover).</li></ul>
Flex Clean does not work.	<ul style="list-style-type: none"><li>• Oven control not set properly. Review instructions in Flex Clean section.</li></ul>
Soil not completely removed after Flex Clean.	<ul style="list-style-type: none"><li>• Flex Clean was interrupted. Review instructions in Flex Clean section.</li><li>• Excessive spillovers on oven bottom. Remove before starting Flex Clean.</li><li>• Failure to clean soil from the oven frame, the door liner outside the oven door gasket and the small area at the front center of the oven bottom. These areas are not in the self-cleaning area, but get hot enough to burn on residue. Clean these areas before the self-cleaning cycle is started. Burned-on residue can be cleaned with a stiff nylon brush and water or a nylon scrubber. Be careful not to damage the oven gasket.</li></ul>
Oven racks discolored.	<ul style="list-style-type: none"><li>• Oven racks left in oven cavity during Flex Clean. Always remove oven racks from oven cavity before starting a self-clean cycle. Clean by using a mild, abrasive cleaner following manufacturer's instructions. Rinse with clean water, dry and replace in oven.</li></ul>
Convection fan does not rotate.	<ul style="list-style-type: none"><li>• Oven door is open. Convection fan will turn off if oven door is opened when Convection is active. Close oven door.</li></ul>



## Before You Call • Solutions to common problems

Problem	Solution
Scratches or abrasions on cooktop surface.	<ul style="list-style-type: none"><li>• Coarse particles such as salt or hardened soils between cooktop and utensils can cause scratches. Be sure cooktop surface and bottoms of utensils are clean before usage. Small scratches do not affect cooking and will become less visible with time.</li><li>• Cleaning materials not recommended for ceramic-glass cooktop have been used. Apply the recommended CookTop® Cleaning Creme to the ceramic surface (on the web visit <a href="http://www.sears.com">www.sears.com</a> for replacement cooktop cleaner, item number 40079). Buff with a non-abrasive cloth or no-scratch cleaning pad. For more information see “Cooktop maintenance” and “Cooktop cleaning” in the Care and Cleaning section of this Use &amp; Care Guide.</li><li>• Cookware with rough bottom was used. Use smooth, flat-bottomed cookware.</li></ul>
Metal marks on the cooktop.	<ul style="list-style-type: none"><li>• Sliding or scraping of metal utensils on cooktop surface. Do not slide metal utensils on cooktop surface. Apply the recommended CookTop® Cleaning Creme to the ceramic surface (on the web visit <a href="http://www.sears.com">www.sears.com</a> for replacement cooktop cleaner, item number 40079). Buff with a non-abrasive cloth or no-scratch cleaning pad. For more information see “Cooktop maintenance” and “Cooktop cleaning” in the Care &amp; Cleaning section of this Use &amp; Care Guide.</li></ul>
Brown streaks or specks on cooktop surface.	<ul style="list-style-type: none"><li>• Boilovers are cooked onto surface. Use razor blade scraper to remove soil. For more information see “Cooktop maintenance” and “Cooktop cleaning” in the Care and Cleaning section of this Use &amp; Care Guide.</li></ul>
Areas of discoloration with metallic sheen on cooktop surface.	<ul style="list-style-type: none"><li>• Mineral deposits from water and food. Remove using the recommended CookTop® Cleaning Creme to the ceramic surface (on the web visit <a href="http://www.sears.com">www.sears.com</a> for replacement cooktop cleaner, item number 40079). Buff with a non-abrasive cloth or no-scratch cleaning pad.</li></ul>

## Notes

## Protection Agreements

### Master Protection Agreements

*Congratulations on making a smart purchase. Your new Kenmore® product is designed and manufactured for years of dependable operation. But like all products, it may require preventive maintenance or repair from time to time. That's when having a Master Protection Agreement can save you money and aggravation.*

The Master Protection Agreement also helps extend the life of your new product. Here's what the Agreement\* includes:

- ☑ **Parts and labor** needed to help keep products operating properly **under normal use**, not just defects. Our coverage goes **well beyond the product warranty**. No deductibles, no functional failure excluded from coverage – **real protection**.
- ☑ **Expert service** by a force of more than **10,000 authorized Sears service technicians**, which means someone you can trust will be working on your product.
- ☑ **Unlimited service calls and nationwide service**, as often as you want us, whenever you want us.
- ☑ **"No-lemon" guarantee** – replacement of your covered product if four or more product failures occur within twelve months.
- ☑ **Product replacement** if your covered product can't be fixed.
- ☑ **Annual Preventive Maintenance Check** at your request – no extra charge.
- ☑ **Fast help by phone** – we call it **Rapid Resolution** – phone support from a Sears representative on all products. Think of us as a "talking owner's manual".
- ☑ **Power surge protection** against electrical damage due to power fluctuations.
- ☑ **\$250 Food Loss Protection** annually for any food spoilage that is the result of mechanical failure of any covered refrigerator or freezer.
- ☑ **Rental reimbursement** if repair of your covered product takes longer than promised.
- ☑ **10% discount** off the regular price of any non-covered repair service and related installed parts.

Once you purchase the Agreement, a simple phone call is all that it takes for you to schedule service. You can call anytime day or night, or schedule a service appointment online.

The Master Protection Agreement is a risk free purchase. If you cancel for any reason during the product warranty period, we will provide a full refund. Or, a prorated refund anytime after the product warranty period expires. Purchase your Master Protection Agreement today!

**Some limitations and exclusions apply. For prices and additional information in the U.S.A. call 1-800-827-6655.**

**\* Coverage in Canada varies on some items. For full details call Sears Canada at 1-800-361-6665.**

### Sears Installation Service

*For Sears professional installation of home appliances, garage door openers, water heaters, and other major home items, in the U.S.A. or Canada call 1-800-4-MY-HOME®.*

## Acuerdos de protección

### Acuerdos maestros de protección

*Enhorabuena por haber hecho una compra inteligente. Su nuevo producto Kenmore® está diseñado y fabricado para brindarle años de funcionamiento fiable. Pero, como cualquier producto, puede necesitar mantenimiento preventivo o reparaciones periódicas. Es por eso que tener un Acuerdo maestro de protección podría ahorrarle dinero y molestias.*

El Acuerdo maestro de protección también sirve para prolongar la durabilidad de su nuevo producto. El acuerdo\* incluye lo siguiente:

- ☑ **Piezas y mano de obra** necesarias para contribuir a mantener el funcionamiento adecuado de los productos **utilizados en condiciones normales de uso**, no sólo en caso de defectos de los productos. Nuestra cobertura va **mucho más allá que la garantía del producto**. No se aplican deducibles ni exclusiones por fallas del funcionamiento: es decir, **verdadera protección**.
- ☑ **Servicio técnico por expertos** (más de **10000 técnicos autorizados de Sears**), lo cual significa que quien repare o realice el mantenimiento de su producto será un profesional de confianza.
- ☑ **Servicio técnico a escala nacional y número ilimitado de llamadas de solicitud de servicio técnico**: se puede poner en contacto con nosotros cuantas veces lo desee y cuando lo desee.
- ☑ **Garantía "sin sorpresas"**: se reemplaza el producto cubierto por el acuerdo si ocurren cuatro o más fallas del producto en un periodo de 12 meses.
- ☑ **Reemplazo del producto**: en caso de que no se pueda reparar el producto cubierto por el acuerdo.
- ☑ **Revisión anual preventiva de mantenimiento del producto**: puede solicitarla en cualquier momento, sin costo alguno.
- ☑ **Rápida asistencia telefónica**, la cual denominamos **Solución rápida**: es decir, asistencia telefónica a través de cualquiera de nuestros representantes de Sears, sobre cualquiera de nuestros productos. Piense en nosotros como en un "manual parlante del usuario".
- ☑ **Protección contra fallas eléctricas**, contra daños debidos a fluctuaciones de la corriente eléctrica.
- ☑ **\$250 al año para cubrir cualquier posible deterioro de alimentos** que haya tenido que desechar debido a una falla mecánica de cualquiera de nuestros refrigeradores o congeladores cubiertos por este acuerdo.
- ☑ **Devolución de gastos de alquiler de electrodomésticos** si la reparación de su producto asegurado toma más que el tiempo prometido.
- ☑ **10% de descuento** aplicable tanto a los costos del servicio de reparación, como de las piezas instaladas relacionadas que no hayan quedado cubiertos por este acuerdo.

Una vez que haya realizado el pago de este acuerdo, bastará una simple llamada telefónica para concertar una visita de servicio. Puede llamar a cualquier hora del día o de la noche, o bien concertar una visita de servicio por Internet.

La adquisición del Acuerdo maestro de protección es una inversión exenta de riesgos. Si por cualquier motivo decide cancelar dicho acuerdo durante el periodo de garantía del producto, le haremos un reintegro total del valor. O bien un importe proporcional si cancela el acuerdo en cualquier otro momento posterior al vencimiento del periodo de garantía del producto. ¡Adquiera hoy mismo su Acuerdo maestro de protección!

**Algunas limitaciones y exclusiones podrían aplicarse. Para solicitar precios e información adicional, llame al 1-800-827-6655 (en los EE.UU.).**

**\* La cobertura en Canadá varía en el caso de algunos artículos. Para obtener detalles completos al respecto, llame al 1-800-361-6665 de Sears de Canadá.**

### Servicio de instalación de Sears

*Para solicitar la instalación por profesionales de Sears de electrodomésticos, abridores de puertas de garage, calentadores de agua y otros artículos de uso prioritario en el hogar, llame al 1-800-4-MY-HOME en los EE.UU. o Canadá.*

# Get it fixed, at your home or ours!

## Your Home

For troubleshooting, product manuals and expert advice:



[www.managemylife.com](http://www.managemylife.com)

For repair – **in your home** – of **all** major brand appliances, lawn and garden equipment, or heating and cooling systems, **no matter who made it, no matter who sold it!**

For the replacement parts, accessories and owner's manuals that you need to do-it-yourself.

For Sears professional installation of home appliances and items like garage door openers and water heaters.

**1-800-4-MY-HOME<sup>®</sup>** (1-800-469-4663)

Call anytime, day or night (U.S.A. and Canada)

[www.sears.com](http://www.sears.com)    [www.sears.ca](http://www.sears.ca)

## Our Home

For repair of carry-in items like vacuums, lawn equipment, and electronics, call anytime for the location of your nearest

**Sears Parts & Repair Service Center**

**1-800-488-1222** (U.S.A.)

[www.sears.com](http://www.sears.com)

**1-800-469-4663** (Canada)

[www.sears.ca](http://www.sears.ca)

To purchase a protection agreement on a product serviced by Sears:

**1-800-827-6655** (U.S.A.)

**1-800-361-6665** (Canada)

Para pedir servicio de reparación a domicilio, y para ordenar piezas:

**1-888-SU-HOGAR<sup>®</sup>**

(1-888-784-6427)

[www.sears.com](http://www.sears.com)

Au Canada pour service en français:

**1-800-LE-FOYER<sup>MC</sup>**

(1-800-533-6937)

[www.sears.ca](http://www.sears.ca)

The Sears logo, featuring the word "Sears" in a large, stylized, serif font with a shadow effect.

® Registered Trademark / <sup>TM</sup> Trademark of KCD IP, LLC in the United States, or Sears Brands, LLC in other countries

® Marca Registrada / <sup>TM</sup> Marca de Fábrica de KCD IP, LLC en Estados Unidos, o Sears Brands, LLC in otros países

<sup>MC</sup> Marque de commerce / <sup>MD</sup> Marque déposée de Sears Brands, LLC