

HEALTHY HOME VACUUM™

USER'S GUIDE
16N5 SERIES



3 Safety Instructions

4 Product View

5 Assembly

6-9 Operation

10-15 Maintenance and Care

16-17 Troubleshooting

18 Consumer Services

**19 Replacement Parts
and Accessories**

20 Warranty



Thank you for buying a BISSELL Healthy Home Vacuum™

We're glad you purchased a BISSELL vacuum. Everything we know about floor care went into the design and construction of this complete, high-tech home cleaning system. By purchasing this product you are helping BISSELL with our commitment to reducing our impact on the environment through an expanding range of sustainable design efforts.

Your vacuum is well made, and we back it with a limited five year warranty. We also stand behind it with a knowledgeable, dedicated Consumer Services department, so, should you ever have a problem, you'll receive fast, considerate assistance.

My great-grandfather invented the floor sweeper in 1876. Today, BISSELL is a global leader in the design, manufacture, and service of high quality homecare products like your carpet cleaner.

Thanks again, from all of us at BISSELL.

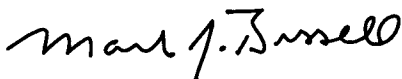

Mark J. Bissell
President and Chief Executive Officer

IMPORTANT SAFETY INSTRUCTIONS

When using an electrical appliance, basic precautions should be observed, including the following:

READ ALL INSTRUCTIONS BEFORE USING YOUR UPRIGHT VACUUM.

Always connect to a polarized outlet (one slot is wider than the other). Unplug from outlet when not in use and before conducting maintenance.

WARNING: To reduce the risk of fire, electric shock, or injury:

- Do not modify the polarized plug to fit a non-polarized outlet or extension cord.
- Do not leave vacuum cleaner unattended when it is plugged in.
- Unplug from outlet when not in use and before servicing.
- Do not use outdoors or on wet surfaces.
- Do not allow children to operate vacuum cleaner or use as a toy.
- Close attention is necessary when used by or near children.
- Do not use for any purpose other than described in this User's Guide.
- Use only manufacturer's recommended attachments.
- Do not use with damaged cord or plug.
- If appliance is not working as it should, has been dropped, damaged, left outdoors, or dropped into water, have it repaired at an authorized service center.
- Do not pull or carry by cord, use cord as a handle, close a door on cord, or pull cord around sharp edges or corners. Do not run appliance over cord. Keep cord away from heated surfaces.
- Do not unplug by pulling on cord. To unplug, grasp the plug, not the cord.
- Do not handle vacuum cleaner or plug with wet hands.
- Do not put any object into openings. Do not use with any opening blocked; keep openings free of dust, lint, hair, and anything that may reduce air flow.
- Keep hair, loose clothing, fingers, and all parts of body away from openings and moving parts.

- Turn off all controls before plugging or unplugging vacuum cleaner.
- Use extra care when cleaning stairs.
- Unplug before attaching the TurboBrush.
- Do not pick up flammable materials (lighter fluid, gasoline, kerosene, etc.) or use in the presence of explosive liquids or vapors.
- Do not pick up toxic material (chlorine bleach, ammonia, drain cleaner, etc.).
- Do not use vacuum cleaner in an enclosed space filled with vapors given off by oil base paint, paint thinner, some moth proofing substances, flammable dust, or other explosive or toxic vapors.
- Do not pick up hard or sharp objects such as glass, nails, screws, coins, etc.
- Do not pick up anything that is burning or smoking, such as cigarettes, matches, or hot ashes.
- Do not use without filters in place.
- Use only on dry, indoor surfaces.
- Keep appliance on a level surface.
- Do not carry the vacuum cleaner while it is running.
- Brush may unexpectedly restart. Unplug from outlet when cleaning or servicing.

SAVE THESE INSTRUCTIONS FOR FUTURE USE

THIS APPLIANCE HAS A POLARIZED PLUG.

To reduce the risk of electric shock, this appliance has a polarized plug (one blade is wider than the other). This plug will fit in a polarized outlet only one way. If the plug does not fit fully in the outlet, reverse the plug. If it still does not fit, contact a qualified electrician to install a proper outlet. Do not change the plug in any way.

This model is for household use only.

Product view

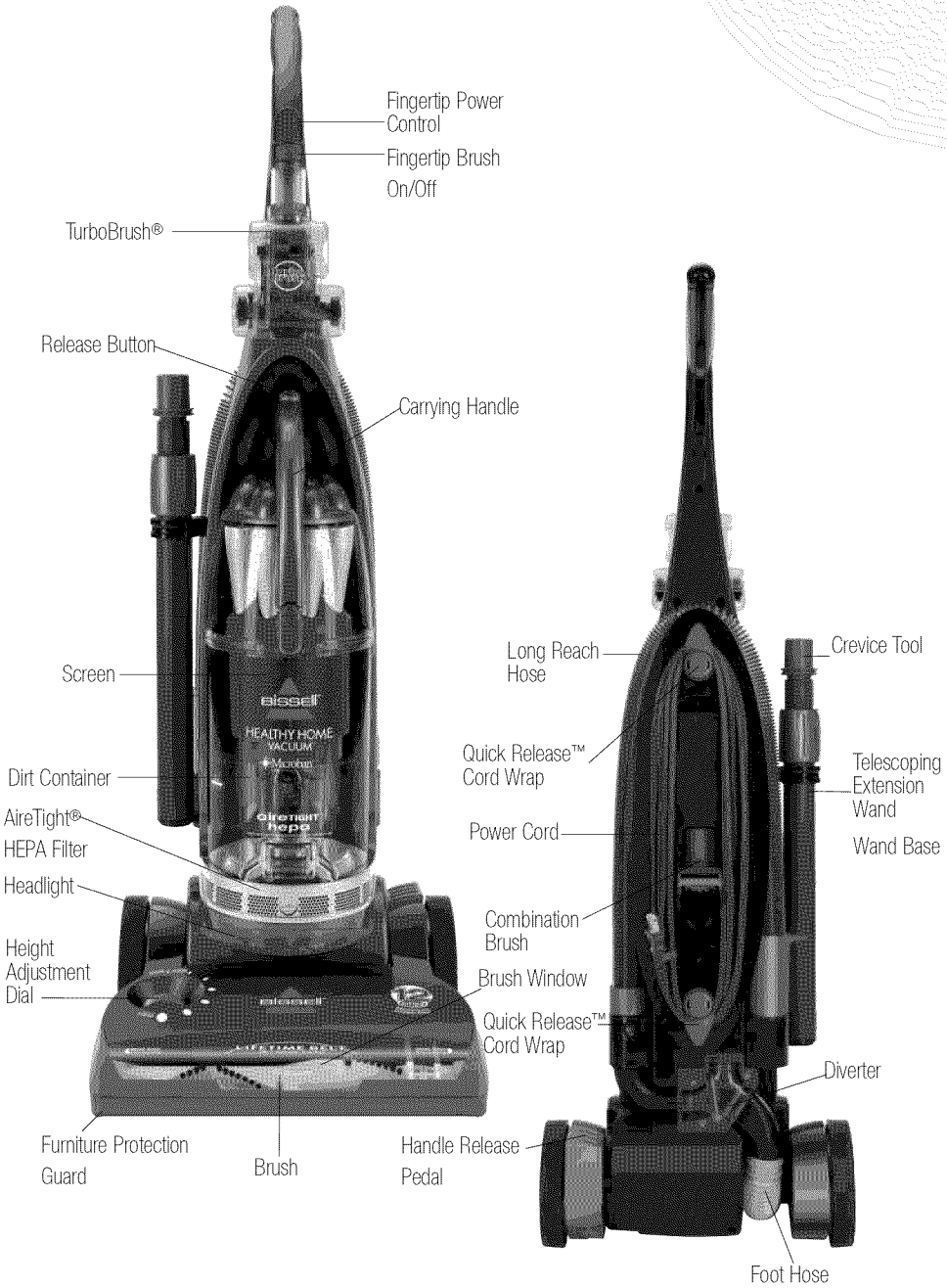

Assembly

Tool required: Phillips screwdriver

1. Slide upper handle into lower handle by pushing forward. Insert two long screws into the holes marked with arrows and tighten both until snug.
2. Attach hose rack by placing the rack over the center back portion of the vacuum. Be sure to feed the power cord through the hole in the center of the rack. Line up both screws holes and use the two smaller screws to attach. Tighten both until snug.
3. Attach hose by placing the tabbed end into the lower left opening on corded side of the vacuum. Make sure the tab on the hose cuff and the hole in the vacuum line up. Place the working end of the hose into the hole on the side with the extension wand guides.
4. Arrange the hose so it lays between the vacuum and the rack.
5. Store the TurboBrush on the front of the handle by aligning the slot on the bottom with the tab on the handle. Snap into place.
6. Store the Combination Brush in the slot shown.
7. Make sure the crevice tool is inside the extension wand. Store tools on vacuum as shown.



CAUTION:

Do not plug in your vacuum cleaner until you are familiar with all instructions and operating procedures.

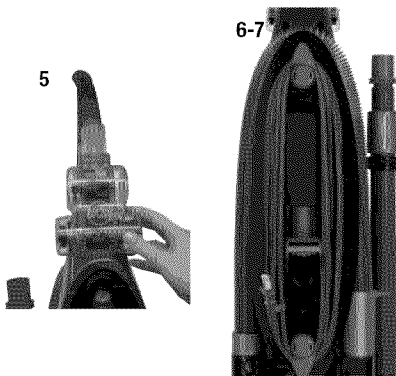
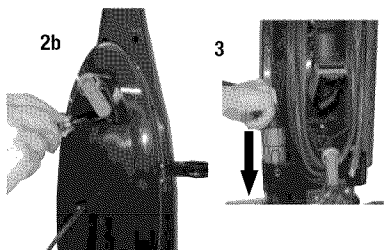
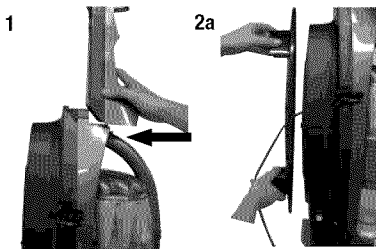

Operation

Transporting your cleaner

Use the handle on the front to carry the cleaner or place the cleaner in the upright position and tip back to roll on the rear wheels.

Releasing the power cord

The upper and lower cord wraps rotate to allow for quick and easy removal of the power cord.

Fingertip power switch

The power button is located at the top of the vacuum handle.

To turn cleaner on, press  button once.

To turn cleaner OFF, press  button again.

Note: The rotating brush will not turn on unless the unit is in the reclined position and the brush switch is on.

Handle positions

Use your foot to pull the handle release pedal back to recline the vacuum cleaner.

Height adjustment

There are seven height settings available for various floor surfaces. Turn the dial on the foot of the cleaner to the desired setting.

Lowest setting – For low pile carpet or bare floors. To pick up debris it may be necessary to move up one setting.

Medium settings – For medium pile carpet.

High setting – For high pile and most shag carpet.

Note: For optimal carpet cleaning performance, adjust to the lowest practical setting. If your cleaner is difficult to push, adjust to the next higher setting.

If the dial is difficult to turn, tilt the cleaner back slightly to take the weight off the foot while turning.

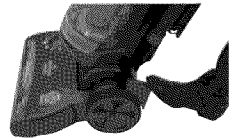
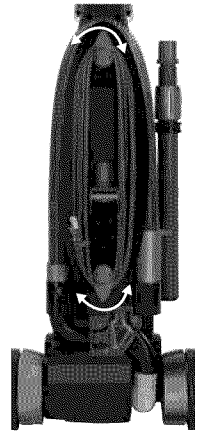
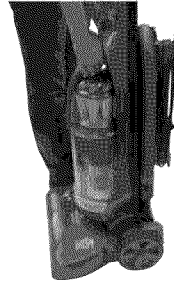

ATTENTION:
Some Berber carpets have a tendency to fuzz with wear. Repeated strokes in the same area may aggravate this condition. Consider setting your cleaner on a higher than normal setting for this type of carpet.

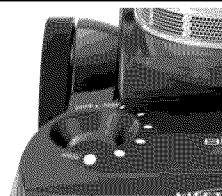

Operation

Fingertip brush switch

The rotating brush is turned on or off using the switch located below the power switch on the top of the handle. The brush will start rotating when the unit is reclined. The brush should be on for most carpeted floors. You may want to turn the brush off for bare floor cleaning or other delicate surfaces.

To turn the brush ON, press  button once.

To turn the brush OFF, press  button again.



Brush auto shut-off feature

When your cleaner is in the upright position, the brush will not rotate. The brush will rotate only when the cleaner is in the reclined position and the brush switch is on.

Microban® antimicrobial product protection

Microban® antimicrobial protection fights the growth of odor causing bacteria, mold and mildew in your vacuum. It is built-in to key components during the manufacturing process and won't wash off or wear away. Microban provides continuous antimicrobial product protection for the useful lifetime of the product keeping your vacuum cleaner and fresher.

Note: This should not replace normal cleaning and maintenance procedures.

Microban is a registered trademark of Microban Products Company.

Operation

Using the tools

1. Make sure the cleaner is in the upright position.
2. Remove the hose wand from the wand base. This automatically diverts the suction to the hose. Unwrap the hose from the cleaner.
3. Use the hose and wand alone or attach any of the tools to the end of the hose wand.

TurboBrush

Use rotating brush action for small areas such as stairs and upholstery.

Note: Press gently when using the TurboBrush to gain maximum cleaning. Too much pressure could cause the brush to stop rotating.

Combination brush

Use longer soft bristles for dusting.

Remove long bristle portion and use shorter stiff bristles when agitation is needed to remove debris.

Crevice tool

Use in tight narrow spaces

Telescoping extension wand

Use with desired attachment for a longer reach. To extend the wand, twist the collar to "Unlock" and push away from you. Twist the collar to "Lock" to lock into place. To retract, twist to unlock, pull toward you and twist to relock.

All available items may not be included with your model. Other tools are available; to order, please refer to page 19.

ATTENTION:

Always place the vacuum cleaner on the floor in its fully upright position when using tools. Placing the vacuum in this position automatically stops the rotating brush.

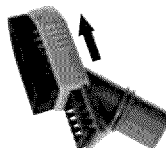
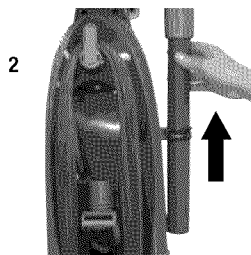

CAUTION:

To avoid personal injury and to prevent the cleaner from falling when cleaning stairs, always place it at the bottom of the stairs.

Operation

Emptying the dirt container

Empty the dirt container as soon as the dirt reaches the "Full" line on the side of the container.

1. Press the release button on top of the carrying handle to remove the dirt container.
2. Choose an emptying method. Method #2 is recommended for allergy sufferers.

Method #1 – hold the dirt container over trash can and push the emptying button to open the bottom (2a). Close the bottom after the dirt empties.

Method #2 – place a plastic bag over the bottom of the dirt container. Push the emptying button through the plastic to open the bottom (2b). After the dust settles, close the bottom and remove the bag to discard.

3. Replace dirt container on cleaner by aligning the bottom and pushing back until it snaps into place.



CAUTION:

Make sure vacuum cleaner has been switched off and unplugged before removing dirt container.

1

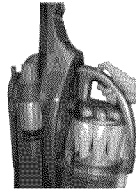

2a

2b

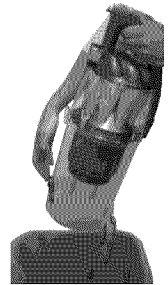

3

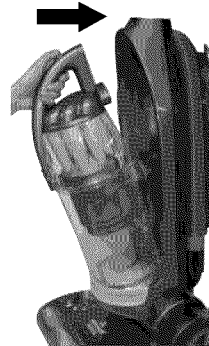

Maintenance and care

Cleaning the dirt container

Additional steps can be taken to clean the dirt container as necessary.

1. Ensure the dirt container has been emptied.
2. Remove the lower portion by pressing the front latch on the upper portion as shown.
3. Clean the screen with a cloth or soft brush to remove dust or debris.
4. If desired, the lower dirt container may be washed in warm water. Make sure it is completely dry before reassembling. **Do not put in dishwasher.**
5. To reassemble, hold the carry handle and place the upper portion into the lower portion, lining up the front and back latches. Push down until both latches click into place. Make sure the dirt container is securely assembled before replacing it on machine.

Cleaning the pre-motor filter

The pre-motor filter should be checked monthly and washed as needed to maintain performance. More or less frequent cleaning may be required based on individual vacuuming habits and types of debris picked up .

1. The filter is located in the door labeled "Filter" behind the dirt container. Push the tab at the top and swing the door down to access.
2. Remove foam filter and hold under running water to wash. Mild detergent may also be used if desired. Wring excess water from filter. **Air dry thoroughly before replacing.**

WARNING:

To reduce the risk of electric shock, turn power switch OFF and disconnect polarized plug from electrical outlet before performing maintenance or troubleshooting checks.

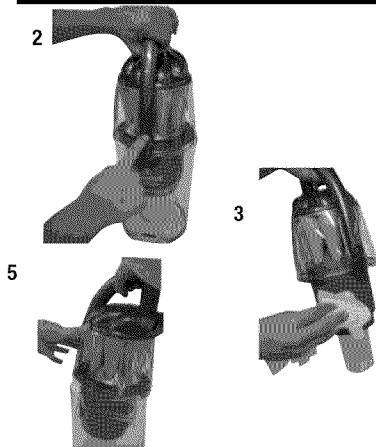

WARNING:

Do not operate the cleaner with a damp or wet filter or without all the filters in place.

Maintenance and care

Replacing the HEPA filter cartridge

The HEPA filter cartridge should be replaced if machine performance is noticeably declining. More or less frequent replacing may be required based on individual vacuuming habits and types of debris picked up.

Note: To have the benefits of the Airtight® HEPA System, you must use the BISSELL HEPA filter cartridge.

1. Remove the dirt container.
2. To remove the HEPA filter cartridge, push in on the front of the filter door to unlatch. Lift up to access.
3. To check or remove, unscrew the center screw.
4. If necessary, replace the used HEPA filter cartridge with a new one.

Note: To avoid damaging the HEPA filter cartridge and reducing its filtration capabilities, be careful not to touch the filter material. The HEPA filter cartridge is not washable.

5. To ensure a tight seal be sure to tighten the filter cartridge screw until snug. **DO NOT OVER TIGHTEN.**

Make sure the filter door latches completely.

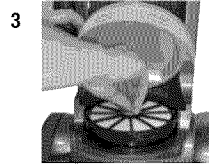
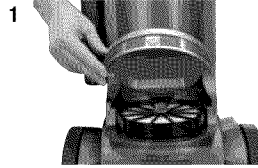

Maintenance and care

Clearing clogs

Low suction or poor pickup may be due to a clog in the vacuum cleaner. If you notice a change in the sound of the motor or a reduction in the spinning action in the dirt container, check for a clog.

If there is no suction or if suction is reduced at the hose, follow these steps to check for and clear the clog:

1. Turn power switch off.
2. Unplug cleaner from electrical outlet.
3. Check the pre-motor filter and clean as necessary (see cleaning your pre-motor filter on page 10).
4. Check the HEPA filter cartridge and replace if necessary (see replacing the HEPA filter cartridge on page 11).
5. Check to see if dirt container is full. Empty if needed.
6. Remove lower portion of dirt container. Clean the screen and check center tubes for dirt accumulation.
7. While dirt container is removed, check dirt inlet for clogs.
8. Remove the hose from the cleaner by pushing on the tab. Straighten the hose and check for a clog.
9. Check diverter area at back of machine for diverter position and clogs. When the hose wand is removed from the base, the diverter should be up to the right. If a clog is visible near the diverter, the plastic cover may be removed to clear the clog by removing the 3 screws as shown (9b).



WARNING:

To reduce the risk of electric shock, turn power switch off and disconnect polarized plug from electrical outlet before performing maintenance or troubleshooting checks.

6

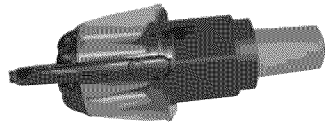

7

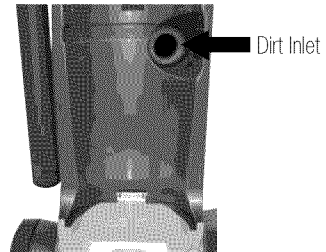

8

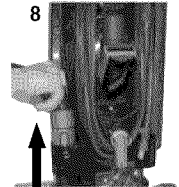

9a

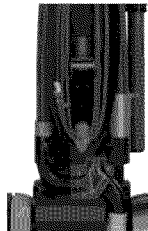

9b

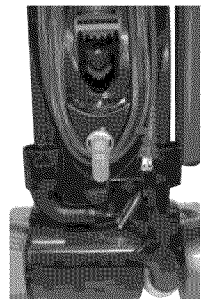

Maintenance and care

Clearing clogs continued

If suction is normal at the hose, follow these steps to check for and clear the clog for floor cleaning:

1. Check diverter area at back of machine for diverter position and clogs. When the hose wand is inserted in the base, the diverter should be to the left. If a clog is visible near the diverter, the plastic cover may be removed to clear the clog by removing the 3 screws.
2. Check the foot hose for clogs (1). If you are not able to tell from the outside if a clog is present, remove the bottom 3 screws from the diverter cover to loosen and straighten the foot hose (2).

Remove any clogs found and fully reassemble the cleaner before attempting to check suction again or using the cleaner.

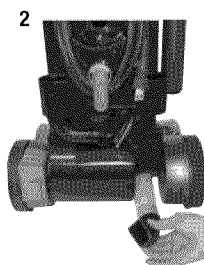
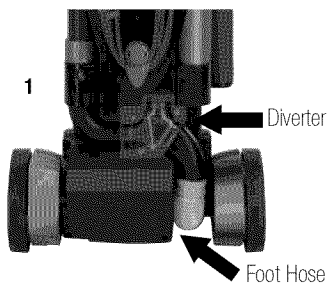

Thermal motor protection

An internal thermal protector has been designed into your cleaner to protect it from overheating. When the thermal protector activates, the main vacuum motor will stop operating. If this happens, proceed as follows.

1. Turn the cleaner OFF and unplug from electrical outlet.
2. Check the cleaner for the source of overheating problem (i.e. full dirt cup, dirty filters or clog).
3. Fix the problem by following the steps in the maintenance section of the user guide.
4. When the motor cools for approximately 30 minutes, the thermal protector automatically resets and cleaning may continue. If the cleaner will not turn on or the thermal protector continues to activate, your cleaner may need servicing. Call BISSELL Consumer Services or visit the website to locate an authorized Service Center.

Note: The thermal protector controls the main vacuum motor only, not the brush motor. If the thermal protector activates, the brush will continue to operate normally; however, there will be no suction.

Maintenance and care

Brush reset

If something becomes lodged in the foot and the brush shuts off, turn the cleaner off and unplug from the outlet. Remove the obstruction. The brush will automatically reset when the cleaner is plugged in and turned back on.

Brush maintenance

The rotating brush should be checked regularly for accumulating debris that might reduce the cleaning performance of your vacuum.

1. Unplug cleaner from electrical outlet.
2. Recline the handle and turn your cleaner over so the bottom side is up.
3. Carefully cut away any visible hair, fibers or debris from the brush roll.

Do not attempt to disassemble the vacuum foot or to remove the brush roll. If you feel it needs to be checked or replaced, call BISSELL Consumer Services or visit the website to locate an authorized service center.

Belt maintenance

The brush belt is designed to last the useful life of the cleaner when used according to all instructions in the user guide under normal household conditions. If you feel that it needs to be checked or replaced, call BISSELL Consumer Services or visit the website to locate an authorized service center. Do not attempt to disassemble the vacuum foot to change the belt.



CAUTION:

To reduce the risk of injury from moving parts, turn off the vacuum cleaner and disconnect power plug from electrical outlet.

3

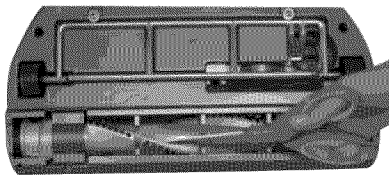

Maintenance and care

Changing the light bulb

1. Turn power switch off.
2. Unplug cleaner from electrical outlet.
3. Recline handle for easier access to light bulb and remove 2 screws to lift off lens.
4. Remove the bulb by grasping bulb and pulling straight out of the socket. Install the new bulb by pushing gently into the socket until the bulb snaps into place.

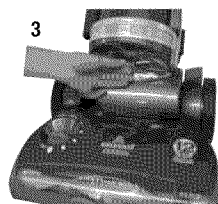
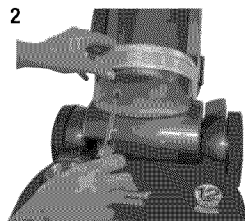

TurboBrush maintenance

The TurboBrush should be checked regularly for clogs or debris wrapping around the brush.

1. Remove tool from hose or front of vacuum.
2. Twist collar so opening is at the top and lift top cover to remove.
3. Remove the brush from the belt and clean debris.
4. Replace the brush inside the belt and place ends into slots on sides as shown.
5. Reposition top cover making sure to line up inside tab at the front with the opening on the cover. Twist collar until opening is at the bottom to lock into place.

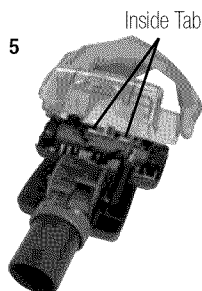
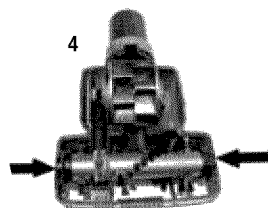
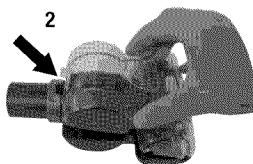

Troubleshooting



WARNING:

To reduce the risk of electric shock, turn power OFF and disconnect polarized plug from electrical outlet before performing maintenance or troubleshooting.

Vacuum cleaner won't turn on

Possible causes

1. Power cord not plugged in
2. Blown fuse/tripped breaker
3. Thermal protector activated
4. Handle not fully attached

Remedies

1. Check electrical plug
2. Check/replace fuse or reset breaker
3. Allow cleaner to cool for 30 minutes, see pg. 13
4. Remove handle and reinstall

Brush not rotating

Possible causes

1. Brush switch turned to "Off"
2. Vacuum is in upright position
3. Brush is jammed
4. Brush needs to be reset
5. Handle not fully attached

Remedies

1. Make sure brush switch is in "On" position
2. Recline vacuum to operate brush
3. Remove obstruction or debris (pg. 14), unplug cleaner to reset brush (pg. 14)
4. Unplug cleaner to reset brush (pg. 14)
5. Remove handle and reinstall

Vacuum cleaner won't pick up or low suction

Possible causes

1. Incorrect height setting
2. Hose wand not properly positioned
3. Dirt container not installed properly
4. Dirt container full
5. Clog in cleaner
6. Filters are dirty
7. Hose not properly attached
8. Fiber door and/or gasket missing or not installed properly

Remedies

1. Turn dial to lower setting
2. Make sure hose wand is fully seated in base and diverter is seated to the left
3. Check assembly of upper and lower portions, correctly position and snap into place
4. Empty dirt container
5. Follow instructions on pg. 12-13 for clearing clogs
6. Check and clean foam filter, check and replace HEPA filter cartridge if needed
7. Make sure hose collar is twisted to lock position
8. Check filter door and gasket to verify.

Troubleshooting

Vacuum cleaner is difficult to push

Possible causes

1. Incorrect height setting

Remedies

1. Turn dial to higher setting

Visible dust escaping from cleaner

Possible causes

1. Filter door and/or gasket missing or not installed properly
2. Foam filter missing or not installed properly
3. HEPA filter cartridge missing or not installed properly
4. Dirt container not installed properly
5. Dirt container not assembled properly
6. Hose not installed properly
7. Hole or crack in hose

Remedies

1. Check filter door and gasket
2. Check foam filter for correct installation
3. Check HEPA filter cartridge for correct installation
4. Make sure dirt container is correctly positioned and snapped into place
5. Check screen, upper and lower portions of the dirt container for proper assembly
6. Make sure hose wand is fully seated in base, and that the hose is assembled correctly to the unit. See page 5. Also make sure foot hose is properly attached to diverter area
7. Check hose for holes or cracks and replace if needed

Other maintenance or service not included in the manual should be performed by an authorized service representative.

Thank you for selecting a BISSELL product.

Please do not return this product to the store.

**For any questions or concerns, BISSELL is happy to be of service.
Contact us directly at 1-800-237-7691.**



BISSELL Consumer Services

For information about repairs or replacement parts, or questions about your warranty, call:

BISSELL Consumer Services
1-800-237-7691

Monday - Friday 8 a.m. — 10 p.m. EST

Saturday 9 a.m. — 8 p.m. EST

Or write:

BISSELL HOMECARE, INC

PO Box 3606

Grand Rapids MI 49501

ATTN: Consumer Services

Or visit the BISSELL website - **www.bissell.com**

When contacting BISSELL, have model number of cleaner available.

Please record your Model Number: _____

Please record your Purchase Date: _____

NOTE: Please keep your original sales receipt. It provides proof of date of purchase in the event of a warranty claim. See Warranty on page 20 for details.

Please register your new BISSELL product at
www.bissell.com/productregistration

Replacement parts and accessories

You may purchase parts from your retailer, by calling BISSELL Consumer Services or by visiting our website. Below is a list of common replacement parts*. While not all of these parts may have come with your specific model, they are available for purchase if desired. Please note, all attachments may not store on board your vacuum.

Item	Part No.	Part Name
1	48G7	HEPA Filter Cartridge
2	63M7	Foam Filter
3	203-1362	TurboBrush
4	203-1364	Telescoping Wand
5	203-1365	Combination Brush
6	203-1363	Crevice Tool
7	203-1382	Contour Tool
8	203-1485	Hose
9	203-1469	Light Bulb

***Not all parts are included with every model. Other tools may be available. Contact BISSELL Consumer Services or visit our website for more detail.**

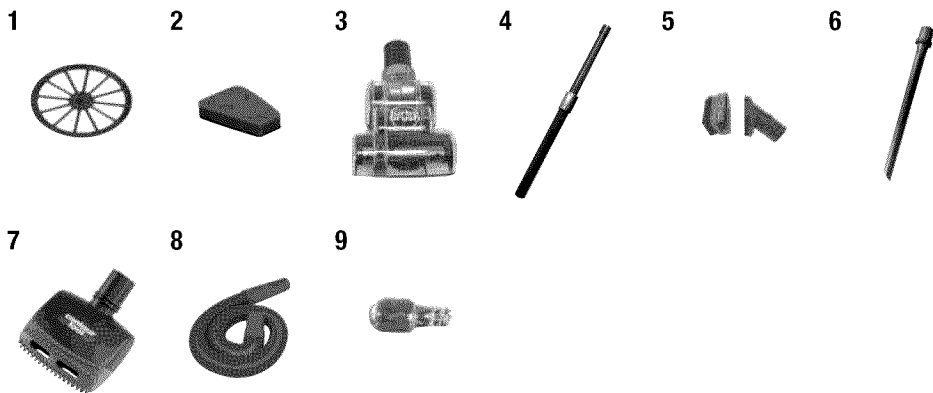

Earn Rewards Points!

To qualify you for discounts, rebates, and other BISSELL perks. Visit www.bissell.com/rewards to learn more.

Warranty - BISSELL Healthy Home Vacuum™

This warranty gives you specific legal rights, and you may also have other rights which may vary from state to state. If you need additional instruction regarding this warranty or have questions regarding what it may cover, please contact BISSELL Consumer Services by E-mail, telephone, or regular mail as described below.

Limited Five Year Warranty

Subject to the ***EXCEPTIONS AND EXCLUSIONS** identified below, upon receipt of the product BISSELL Homecare, Inc. will repair or replace (with new or remanufactured components or products), at BISSELL's option, free of charge from the date of purchase by the original purchaser, for five years on any defective or malfunctioning part.

See information below on "If your BISSELL product should require service".

This warranty applies to product used for personal, and not commercial or rental service. This warranty does not apply to fans or routine maintenance components such as filters, or brushes. Damage or malfunction caused by negligence, abuse, neglect, unauthorized repair, or any other use not in accordance with the User's Guide is not covered.

If your BISSELL product should require service:

Contact BISSELL Consumer Services to locate a BISSELL Authorized Service Center in your area.

If you need information about repairs or replacement parts, or if you have questions about your warranty, contact BISSELL Consumer Services.

Website or E-mail:

www.bissell.com

Use the "Customer Service" tab.

Or Call:

BISSELL Consumer Services

1-800-237-7691

Monday - Friday 8 a.m. - 10 p.m. ET

Saturday 9 a.m. - 8 p.m. ET

Or write:

BISSELL Homecare, Inc.

PO Box 3606

Grand Rapids MI 49501

ATTN: Consumer Services

BISSELL HOMECARE, INC. IS NOT LIABLE FOR INCIDENTAL OR CONSEQUENTIAL DAMAGES OF ANY NATURE ASSOCIATED WITH THE USE OF THIS PRODUCT. BISSELL'S LIABILITY WILL NOT EXCEED THE PURCHASE PRICE OF THE PRODUCT.

Some states do not allow the exclusion or limitation of incidental or consequential damages, so the above limitation or exclusion may not apply to you.

***EXCEPTIONS AND EXCLUSIONS FROM THE TERMS OF THE LIMITED WARRANTY THIS WARRANTY IS EXCLUSIVE AND IN LIEU OF ANY OTHER WARRANTIES EITHER ORAL OR WRITTEN. ANY IMPLIED WARRANTIES WHICH MAY ARISE BY OPERATION OF LAW, INCLUDING THE IMPLIED WARRANTIES OF MERCHANTABILITY AND FITNESS FOR A PARTICULAR PURPOSE, ARE LIMITED TO THE FIVE YEAR DURATION FROM THE DATE OF PURCHASE AS DESCRIBED ABOVE.**

Some states do not allow limitations on how long an implied warranty lasts, so the above limitation may not apply to you.



©2009 BISSELL Homecare, Inc.
Grand Rapids, Michigan
All rights reserved. Printed in China
Part Number 110-4100
Rev 5/09
Visit our website at:
www.bissell.com

