



# Self-Cleaning Dual Fuel Convection Ranges

**Safety Instructions** .....2-8

**Operating Instructions**

Convection Oven .....19-23  
 Roasting Guide .....22  
 Timed Convection Baking .....23  
 Gas/Control Lockout .....25  
 Gas Surface Burners .....9, 11  
 Griddle .....10  
 Lower Oven Drawer .....28  
 Thermostat .....27, 28  
 Upper Oven .....12-27  
 Aluminum Foil .....14  
 Baking or Roasting .....14  
 Broiling Guide .....15  
 Clock and Timer .....16  
 Oven Controls .....12  
 Preheating .....14  
 Probe .....18, 21  
 Sabbath Feature .....26  
 Self-Cleaning .....29, 30  
 Special Features .....24, 25  
 Timed Baking and  
 Roasting Features .....17

**Care and Cleaning**

Burner Grates .....33  
 Burner Caps and Heads .....32  
 Control Panel and Knobs .....37  
 Cooktop Surface .....33  
 Griddle .....34  
 Lift-Off Oven Door .....35  
 Lower Oven Drawer .....36  
 Oven Air Vents .....37  
 Oven Heating Elements .....35  
 Oven Light Replacement .....38  
 Oven Shelves .....38  
 Sealed Burner Assemblies .....31  
 Self-Cleaning .....29, 30  
 Stainless Steel Surfaces .....34

**Installation**

**Instructions** .....39-52  
 Anti-Tip Device .....52  
 Check Ignition of  
 Surface Burners .....50, 51  
 Connect Range  
 to Electric .....44, 46  
 Connect Range to Gas .....43, 45  
 Dimensions and  
 Clearances .....41  
 Electrical Connections .....47-49  
 Level the Range .....51  
 Location Guidelines .....42  
 LP .....52  
 Safety Instructions .....39, 40

**Accessories** .....57

**Troubleshooting Tips** .53-56

**Consumer Support**

Consumer  
 Support .....Back Cover  
 Product Registration .....61, 62  
 Warranty for Customers  
 in Canada .....62  
 Warranty for Customers  
 in the U.S.A. ....61

**Owner's Manual  
& Installation  
Instructions**

C2S980

**Write the model and serial numbers here:**

**Model #** \_\_\_\_\_

**Serial #** \_\_\_\_\_

You can find them on a label on the front of the range behind the lower oven drawer.

In Canada contact us at:  
www.GEAppliances.ca

**IMPORTANT SAFETY INFORMATION.  
READ ALL INSTRUCTIONS BEFORE USING.**

---

Safety Instructions

Operating Instructions

Installation Instructions

Troubleshooting Tips

Consumer Support

**⚠ WARNING:** If the information in this manual is not followed exactly, a fire or explosion may result causing property damage, personal injury or death.

- Do not store or use gasoline or other flammable vapors and liquids in the vicinity of this or any other appliance.
  
- **WHAT TO DO IF YOU SMELL GAS**
  - Do not try to light any appliance.
  - Do not touch any electrical switch; do not use any phone in your building.
  - Immediately call your gas supplier from a neighbor's phone. Follow the gas supplier's instructions.
  - If you cannot reach your gas supplier, call the fire department.
  
- Installation and service must be performed by a qualified installer, service agency or the gas supplier.



# ⚠ WARNING!

For your safety, the information in this manual must be followed to minimize the risk of fire or explosion, electric shock, or to prevent property damage, personal injury, or loss of life.



## ANTI-TIP DEVICE



**⚠ WARNING**

- All ranges can tip.
- BURNS or other SERIOUS INJURIES can result.
- INSTALL and CHECK the ANTI-TIP bracket following the instructions supplied with the bracket.



To reduce the risk of tipping the range, the range must be secured by a properly installed anti-tip bracket. See installation instructions shipped with the bracket for complete details before attempting to install.

To check if the bracket is installed and engaged properly, remove the storage drawer or kick panel and look underneath the range to see that the leveling leg is engaged in the bracket. On models without a storage drawer or kick panel, carefully tip the range forward. The bracket should stop the range within 4 inches. If it does not, the bracket must be reinstalled. If the range is pulled from the wall for any reason, always repeat this procedure to verify the range is properly secured by the anti-tip bracket.

For free-standing or slide-in ranges, never completely remove the leveling legs or the range will not be secured to the anti-tip device properly.

If you did not receive an anti-tip bracket with your purchase, call 1.800.626.8774 to receive one at no cost (in Canada, call 1.800.561.3344). For installation instructions of the bracket, visit [GEAppliances.com](http://GEAppliances.com) (in Canada, [GEAppliances.ca](http://GEAppliances.ca)).

# IMPORTANT SAFETY INFORMATION. READ ALL INSTRUCTIONS BEFORE USING.

## ⚠ WARNING!



### IMPORTANT SAFETY NOTICE

The California Safe Drinking Water and Toxic Enforcement Act requires the Governor of California to publish a list of substances known to the state to cause birth defects or other reproductive harm, and requires businesses to warn customers of potential exposure to such substances.

Gas appliances can cause minor exposure to four of these substances, namely benzene, carbon monoxide, formaldehyde and soot, caused primarily by the incomplete combustion of natural gas or LP fuels. Properly adjusted burners, indicated by a bluish rather than a yellow flame, will minimize incomplete combustion. Exposure to these substances can be minimized by venting with an open window or using a ventilation fan or hood.



### SAFETY PRECAUTIONS

When using electrical appliances, basic safety precautions should be followed, including the following:

- Use this appliance only for its intended purpose as described in this Owner's Manual.
- Be sure your appliance is properly installed and grounded by a qualified technician in accordance with the provided installation instructions.
- Do not attempt to repair or replace any part of your range unless it is specifically recommended in this manual. All other servicing should be referred to a qualified technician.
- Before performing any service, disconnect the range power supply at the household distribution panel by removing the fuse or switching off the circuit breaker.
- Do not leave children alone---children should not be left alone or unattended in an area where an appliance is in use. They should never be allowed to sit or stand on any part of the appliance.
- Do not allow anyone to climb, stand or hang on the door, storage drawer, or cooktop. They could damage the range and even tip it over, causing severe personal injury.
- Do not store flammable materials in an oven or near the cooktop.

**⚠ CAUTION:** *Items of interest to children should not be stored in cabinets above a range or on the backsplash of a range—children climbing on the range to reach items could be seriously injured.*



### SAFETY PRECAUTIONS

Have the installer show you the location of the range gas shut-off valve and how to shut it off if necessary.

- Have your range installed and properly grounded by a qualified installer, in accordance with the Installation Instructions. Any adjustment and service should be performed only by qualified gas range installers or service technicians.
- Do not attempt to repair or replace any part of your range unless it is specifically recommended in this manual. All other service should be referred to a qualified technician.



## SAFETY PRECAUTIONS

- Locate the range out of kitchen traffic path and out of drafty locations to prevent poor air circulation.
- Be sure all packaging materials are removed from the range before operating it to prevent fire or smoke damage should the packaging material ignite.
- Be sure your range is correctly adjusted by a qualified service technician or installer for the type of gas (natural or LP) that is to be used. Your range can be converted for use with either type of gas. See the *Installation of the range* section.
- Never wear loose-fitting or hanging garments while using the appliance. Be careful when reaching for items stored in cabinets over the range. Flammable material could be ignited if brought in contact with flame or hot oven surfaces and may cause severe burns.
- Do not store flammable materials in an oven, a range drawer or near a cooktop.
- Do not store or use combustible materials, gasoline or other flammable vapors and liquids in the vicinity of this or any other appliance.

**⚠ WARNING:** *These adjustments must be made by a qualified service technician in accordance with the manufacturer's instructions and all codes and requirements of the authority having jurisdiction. Failure to follow these instructions could result in serious injury or property damage. The qualified agency performing this work assumes responsibility for the conversion.*

- After prolonged use of a range, high floor temperatures may result and many floor coverings will not withstand this kind of use. Never install the range over vinyl tile or linoleum that cannot withstand such type of use. Never install it directly over interior kitchen carpeting.
- Do not leave children alone or unattended where a range is hot or in operation. They could be seriously burned.
- Do not allow anyone to climb, stand or hang on the oven door, drawer or cooktop. They could damage the range and even tip it over, causing severe personal injury.
- Do not let cooking grease or other flammable materials accumulate in or near the range.
- Do not use water on grease fires. Never pick up a flaming pan. Turn the controls off. Smother a flaming pan on a surface burner by covering the pan completely with a well-fitting lid, cookie sheet or flat tray. Use a multi-purpose dry chemical or foam-type fire extinguisher.

Flaming grease outside a pan can be put out by covering it with baking soda or, if available, by using a multi-purpose dry chemical or foam-type fire extinguisher.

Flame in the upper oven or lower oven drawer can be smothered completely by closing the oven door or drawer and turning the control to off, or by using a multi-purpose dry chemical or foam-type fire extinguisher.

**⚠ CAUTION:** *Items of interest to children should not be stored in cabinets above a range or on the backsplash of a range—children climbing on the range to reach items could be seriously injured.*

- For your safety, never use your appliance for warming or heating the room.
- Large scratches or impacts to glass doors can lead to broken or shattered glass.
- Let the burner grates and other surfaces cool before touching them or leaving them where children can reach them.
- Never block the vents (air openings) of the range. They provide the air inlet and outlet that are necessary for the range to operate properly with correct combustion. Air openings are located at the rear of the cooktop, at the top and bottom of the oven door, and at the bottom of the range under the lower oven drawer or kick panel.
- Do not lift the cooktop. Lifting the cooktop can lead to damage and improper operation of the range.

# IMPORTANT SAFETY INFORMATION. READ ALL INSTRUCTIONS BEFORE USING.

## ⚠️ WARNING!



### SURFACE BURNERS

Use proper pan size—avoid pans that are unstable or easily tipped. Select cookware having flat bottoms large enough to cover burner grates. To avoid spillovers, make sure cookware is large enough to contain the food properly. This will both save cleaning time and prevent hazardous accumulations of food, since heavy spattering or spillovers left on range can ignite. Use pans with handles that can be easily grasped and remain cool.

- Always use the **LITE** position when igniting the top burners and make sure the burners have ignited.
- Never leave the surface burners unattended at high flame settings. Boilovers cause smoking and greasy spillovers that may catch on fire.
- Adjust the top burner flame size so it does not extend beyond the edge of the cookware. Excessive flame is hazardous.
- Use only dry pot holders—moist or damp pot holders on hot surfaces may result in burns from steam. Do not let pot holders come near open flames when lifting cookware. Do not use a towel or other bulky cloth in place of a pot holder.
- When using glass cookware, make sure it is designed for top-of-range cooking.
- To minimize the possibility of burns, ignition of flammable materials and spillage, turn cookware handles toward the side or back of the range without extending over adjacent burners.
- Carefully watch foods being fried at a high flame setting.
- Always heat fat slowly, and watch as it heats.
- Do not leave any items on the cooktop. The hot air from the vent may ignite flammable items and will increase pressure in closed containers, which may cause them to burst.
- If a combination of oils or fats will be used in frying, stir together before heating or as fats melt slowly.
- Use a deep fat thermometer whenever possible to prevent overheating fat beyond the smoking point.
- Use the least possible amount of fat for effective shallow or deep-fat frying. Filling the pan too full of fat can cause spillovers when food is added.
- Do not flame foods on the cooktop. If you do flame foods under the hood, turn the fan on.
- Do not use a wok on the cooking surface if the wok has a round metal ring that is placed over the burner grate to support the wok. This ring acts as a heat trap, which may damage the burner grate and burner head. Also, it may cause the burner to work improperly. This may cause a carbon monoxide level above that allowed by current standards, resulting in a health hazard.
- Foods for frying should be as dry as possible. Frost on frozen foods or moisture on fresh foods can cause hot fat to bubble up and over the sides of the pan.
- Never try to move a pan of hot fat, especially a deep fat fryer. Wait until the fat is cool.
- Do not leave plastic items on the cooktop—they may melt if left too close to the vent.
- Keep all plastics away from the surface burners.
- To avoid the possibility of a burn, always be certain that the controls for all burners are at the **OFF** position and all grates are cool before attempting to remove them.
- If range is located near a window, do not hang long curtains that could blow over the surface burners and create a fire hazard.
- If you smell gas, turn off the gas to the range and call a qualified service technician. Never use an open flame to locate a leak.
- Always turn the surface burner controls off before removing cookware.
- When disabling Gas/Control Lockout, make sure the surface controls are set to the **OFF** position. This will preclude gas flow when the range is turned on.

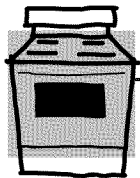

## LOWER OVEN DRAWER

- The purpose of the warm setting of the lower oven drawer is to hold hot cooked foods at serving temperature. Always start with hot food; cold food cannot be heated or cooked using the warm setting of the lower oven drawer.
- Do not use the lower oven drawer to dry newspapers. If overheated, they can catch on fire.
- Do not leave paper products, plastics, canned food or combustible materials in the drawer.
- Never leave jars or cans of fat drippings in or near your lower oven drawer.
- Do not warm food in the lower oven drawer for more than two hours.
- **Do not touch the heating element or the interior surface of the lower oven drawer.** These surfaces may be hot enough to burn.
- **REMEMBER:** The inside surface of the lower oven drawer may be hot when the drawer is opened.
- Use care when opening the lower oven drawer. Open the drawer a crack and let hot air or steam escape before removing or replacing food. Hot air or steam which escapes can cause burns to hands, face and/or eyes.
- Do not use aluminum foil to line the lower oven drawer. Foil is an excellent heat insulator and will trap heat beneath it. This will upset the performance of the drawer and it could damage the interior finish.
- Never place, use or self-clean the lower oven drawer pan in the upper oven.

# IMPORTANT SAFETY INFORMATION. READ ALL INSTRUCTIONS BEFORE USING.



## COOK MEAT AND POULTRY THOROUGHLY...

Cook meat and poultry thoroughly—meat to at least an INTERNAL temperature of 160°F and poultry to at least an INTERNAL temperature of 180°F. Cooking to these temperatures usually protects against foodborne illness.



## UPPER OVEN

Stand away from the range when opening the door of a hot oven. The hot air and steam that escape can cause burns to hands, face and eyes.

- Do not use the oven for a storage area. Items stored in the oven can ignite.
- Keep the oven free from grease buildup.
- Place the oven shelves in the desired position while the oven is cool. If shelves must be handled when hot, do not let pot holder contact the heating elements.
- Pulling out the shelf to the stop-lock is a convenience in lifting heavy foods. It is also a precaution against burns from touching hot surfaces of the door or oven walls. The lowest position "R" is not designed to slide.
- Do not heat unopened food containers. Pressure could build up and the container could burst, causing an injury.
- When using cooking or roasting bags in the oven, follow the manufacturer's directions.
- Do not use your oven to dry newspapers. If overheated, they can catch fire.
- Do not leave paper products, cooking utensils or food in the oven when not in use.
- Keep the oven vent unobstructed.
- Make sure any broiler pan is in place correctly to reduce the possibility of grease fires.
- If you should have a grease fire in a broiler pan, press the **CLEAR/OFF** pad and keep the oven door closed to contain fire until it burns out.
- Never place, use or self-clean the lower oven drawer pan in the upper oven.



## SELF-CLEANING UPPER OVEN

- Be sure to wipe up excess spillage before self-cleaning operation.
- Before self-cleaning the oven, remove the shelves, any broiler pan, grid and other cookware.
- Never place, use or self-clean the lower oven drawer pan in the upper oven.
- Do not clean the door gasket. The door gasket is essential for a good seal. Care should be taken not to rub, damage or move the gasket.
- Clean only parts listed in this Owner's Manual.
- If the self-cleaning mode malfunctions, turn the oven off and disconnect the power supply. Have it serviced by a qualified technician.
- Do not use oven cleaners. No commercial oven cleaner or oven liner of any kind should be used in or around any part of the oven. Residue from oven cleaners will damage the inside of the oven when the self-clean cycle is used.



READ AND FOLLOW THIS SAFETY INFORMATION CAREFULLY.  
**SAVE THESE INSTRUCTIONS**



# Using the gas surface burners.

Throughout this manual, features and appearance may vary from your model.

## Before Lighting a Gas Burner

- Make sure all burners are in place.
- Make sure all grates on the range are properly placed before using any burner.
- If your range has the Gas/Control Lockout feature, make sure it is disabled before attempting to light the surface burners.

## After Lighting a Gas Burner

- Do not operate the burner for an extended period of time without cookware on the grate. The finish on the grate may chip without cookware to absorb the heat.
- Be sure the burners and grates are cool before you place your hand, a pot holder, cleaning cloths or other materials on them.

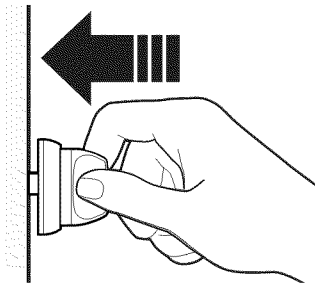

Push the control knob in and turn it to the **LITE** position.

## How to Light a Gas Surface Burner

Make sure all the surface burners are placed in their respective positions.

Push the control knob in and turn it to the **LITE** position.

You will hear a little **clicking** noise—the sound of the electric spark igniting the burner.

Turn the knob to adjust the flame size. If the knob stays at **LITE**, it will continue to click.

When one burner is turned to **LITE**, all the burners spark. Do not attempt to disassemble or clean around any burner while another burner is on. An electric shock may result, which could cause you to knock over hot cookware.

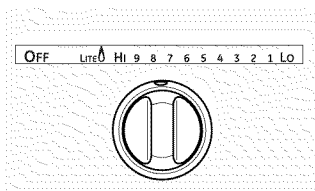
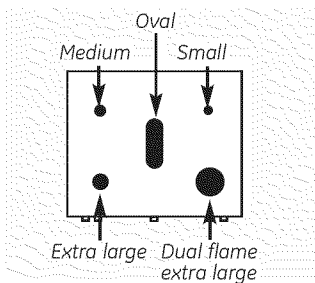

Small, medium and center burner graphics only.

## Sealed Gas Burners

Your gas range cooktop has five sealed gas burners. They offer convenience, cleanability and flexibility to be used in a wide range of cooking applications.

The smallest burner in the right rear position is the simmer burner. This burner can be turned down to **LO** for a very low simmer setting. It provides precise cooking performance for delicate foods such as sauces or foods that require low heat for a long cooking time.

The medium (left rear) and the large (left front) burners are the primary burners for most cooking. These general-purpose burners can be turned down from **HI** to **LO** to suit a wide range of cooking needs. The extra large (left front) burner also has a special **POWER BOIL™** setting designed to be used with cookware 10 inches or larger in diameter.

The dual flame extra large burner (right front) is the maximum output burner. Like the other four burners, it can be turned down from **HI** to **LO** for a wide range of cooking applications; however, this burner is designed to quickly bring large amounts of liquid to a boil. It has a special **POWER BOIL™** setting designed to be used with cookware 10 inches or larger in diameter.

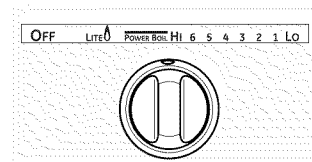

Extra large and dual flame extra large burners only.

The center oval burner is the largest in size and is for large oval pots/pans, round pots/pans 10" or greater in diameter or to be used with the griddle.

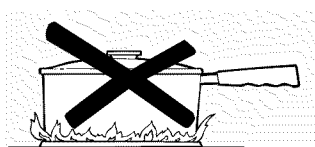

## How to Select Flame Size

For safe handling of cookware, never let the flames extend up the sides of the cookware.

Watch the flame, not the knob, as you reduce heat. When fast heating is desired, the flame size on a gas burner should match the cookware you are using.

Flames larger than the bottom of the cookware will not result in faster heating of the cookware and could be hazardous.

## Using the griddle.

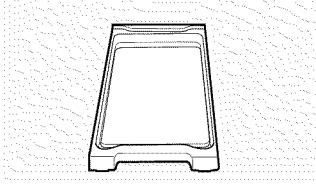

Your non-stick coated griddle provides an extra-large cooking surface for meats, pancakes or other food usually prepared in a frying pan or skillet.

**NOTE:** Your griddle will discolor over time as it becomes seasoned with use.

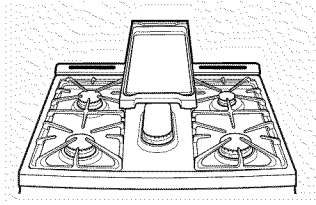

### How to Insert the Griddle

**CAUTION:** Place and remove the griddle only when all grates and griddle are cool and all surface units are turned OFF.

**NOTE:** Do not clean the griddle in the self-cleaning oven.

The griddle can only be used with the center burner. To insert the griddle, remove center grate and replace with griddle.

### Using the Griddle

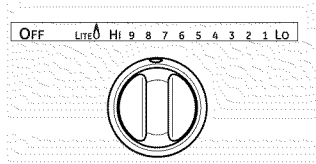

Most griddled foods require cooking on a preheated surface. Preheat griddle according to the guide below, then switch to the desired cook setting.

Type of Food	Preheat Conditions	Cook Setting
Warming Tortillas	none	3 (MED-LOW)
Pancakes	4 (MED) 10 min	4 (MED)
Hamburgers	HI 5 min	5 (MED) Sear on HI for 1 minute each side
Fried Eggs	HI 5 min	4 (MED)
Bacon	None	5 (MED)
Breakfast Sausage Links	HI 5 min	5 (MED)
Hot Sandwiches (such as Grilled Cheese)	HI 4 min	HI

**NOTE:** Griddle settings may need to be adjusted if griddle is used for an extended time.

#### IMPORTANT NOTES:

- Avoid cooking extremely greasy foods and be careful of grease spillover while cooking.
- Do not use oil on the griddle for extended lengths of time. Permanent staining and/or craze lines on the surface could result.
- Never place or store any items on the griddle, even when it is not in use. The griddle can become heated when using the surrounding burners.
- **Do not overheat the griddle.** Leaving the griddle burner on at HI for an extended amount of time without food can damage the non-stick coating.
- Avoid using metal utensils with sharp points or rough, sharp edges that might damage the griddle surface.
- Do not cut foods on the griddle.

## Top-of-Range Cookware

**Aluminum:** Medium-weight cookware is recommended because it heats quickly and evenly. Most foods brown evenly in an aluminum skillet. Use saucepans with tight-fitting lids when cooking with minimum amounts of water.

**Cast-Iron:** If heated slowly, most skillets will give satisfactory results.

**Enamelware:** Under some conditions, the enamel of some cookware may melt. Follow cookware manufacturer's recommendations for cooking methods.

**Glass:** There are two types of glass cookware—those for oven use only and those for top-of-range cooking (saucepans, coffee and teapots). Glass conducts heat very slowly.

**Heatproof Glass Ceramic:** Can be used for either surface or oven cooking. It conducts heat very slowly and cools very slowly. Check cookware manufacturer's directions to be sure it can be used on gas ranges.

**Stainless Steel:** This metal alone has poor heating properties and is usually combined with copper, aluminum or other metals for improved heat distribution. Combination metal skillets usually work satisfactorily if they are used with medium heat as the manufacturer recommends.

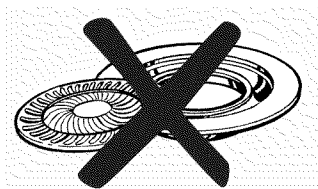

## Stove Top Grills

Do not use stove top grills on your sealed gas burners. If you use the stove top grill on the sealed gas burner, it will cause incomplete combustion and can result in exposure to carbon monoxide levels above allowable current standards.

*This can be hazardous to your health.*



Use a flat-bottomed wok.

## Wok This Way

We recommend that you use a 14-inch or smaller flat-bottomed wok. Make sure the wok bottom sits flat on the grate. They are available at your local retail store.

Only a flat-bottomed wok should be used.

Do not use a wok support ring. Placing the ring over the burner or grate may cause the burner to work improperly, resulting in carbon monoxide levels above allowable standards. This could be dangerous to your health.

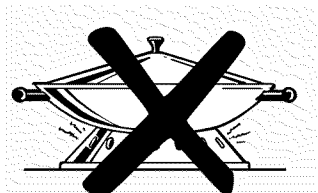

## In Case of Power Failure

In case of a power failure, you can light the gas surface burners on your range with a match. Hold a lit match to the burner, then push in and turn the control knob to the **LITE** position. Use extreme caution when lighting burners this way.

Surface burners in use when an electrical power failure occurs will continue to operate normally.

**NOTE:** If Gas/Control Lockout is in use at the time of a power failure, the surface burners cannot be lit.

## Using the upper oven controls.

(Throughout this manual, features and appearance may vary from your model.)

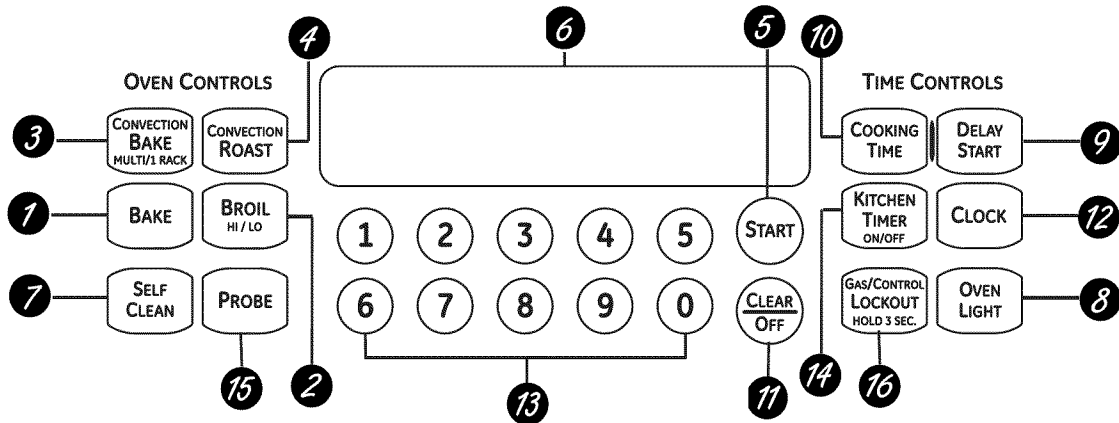

Features and appearance may vary.



### Oven Control, Clock, Timer and Features

- 1** **BAKE Pad**  
Touch to select the bake function.
- 2** **BROIL HI/LO Pad**  
Touch to select the broil function.
- 3** **CONVECTION BAKE MULTI/1 RACK Pad**  
Touch to select baking with the convection function.
- 4** **CONVECTION ROAST Pad**  
Touch to select roasting with the convection function.
- 5** **START Pad**  
Must be touched to start any cooking or cleaning function.
- 6** **Display**  
Shows the time of day, oven temperature, whether the oven is in the bake, broil or self-cleaning mode, the times set for the timer or automatic oven operations, and if the range is locked.
- 7** **SELF-CLEAN Pad**  
Touch to select self-cleaning function. See the *Using the self-cleaning oven* section.  
  
**If "F- and a number or letter" flash in the display and the oven control signals, this indicates a function error code. Touch the CLEAR/OFF pad. Allow the oven to cool for one hour. Put the oven back into operation. If the function error code repeats, disconnect the power to the oven and call for service.**  
  
**If your oven was set for a timed oven operation and a power outage occurred, the clock and all programmed functions must be reset.**  
  
**The time of day will flash in the display when there has been a power outage.**
- 8** **OVEN LIGHT Pad**  
Touch to turn the oven light on or off.
- 9** **DELAY START Pad**  
Use along with **COOKING TIME** or **SELF CLEAN** pads to set the oven to start and stop automatically at a time you set.
- 10** **COOKING TIME Pad**  
Touch and then touch the number pads to set the amount of time you want your food to cook. The oven will shut off when the cooking time has run out.
- 11** **CLEAR/OFF Pad**  
Touch to cancel **ALL** upper oven operations except the clock, timer and Gas/Control Lockout.
- 12** **CLOCK Pad**  
Touch before setting the clock.
- 13** **Number Pads**  
Use to set any function requiring numbers such as the time of day on the clock, the timer, the oven temperature, the internal food temperature, the start time and length of operation for timed baking and self-cleaning.
- 14** **KITCHEN TIMER ON/OFF Pad**  
Touch to select the timer feature.
- 15** **PROBE Pad**  
Touch when using the probe to cook food.
- 16** **GAS/CONTROL LOCKOUT Pad**  
Touch and hold the **GAS/CONTROL LOCKOUT** pad for 3 seconds to lock/unlock the surface burners, oven burners and control panel so they cannot be activated.

# Using the upper oven.

To avoid possible burns, place the shelves in the desired position before you turn the oven on.

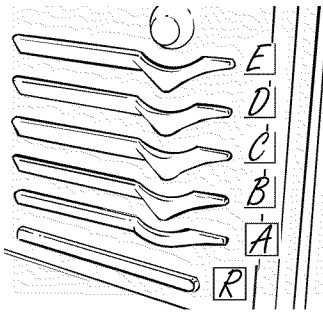

The oven has 5 shelf positions.  
It also has a special low shelf position (R) for extra large items, such as a large turkey.

## Before you begin...

The shelves have stop-locks, so that when placed correctly on the supports, they will stop before coming completely out, and will not tilt.

When placing and removing cookware, pull the shelf out to the bump on the shelf support.

**To remove a shelf,** pull it toward you, tilt the front end up and pull it out.

**To replace,** place the end of the shelf (stop-locks) on the support, tilt up the front and push the shelf in.

**NOTE:** The shelf is not designed to slide out at the special low shelf (R) position.

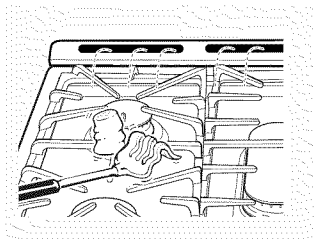

Plastic items on the cooktop may melt if left too close to the vent.  
Vent appearance and location vary.

## Upper Oven Vent

Your oven is vented through ducts at the rear of the range. Do not block these ducts when cooking in the oven—it is important that the flow of hot air from the oven and fresh air to the oven burner be uninterrupted. Avoid touching the vent openings or nearby surfaces during oven or broiler operation—they may become hot.

- Handles of pots and pans on the cooktop may become hot if left too close to the vent.
- Do not leave plastic items on the cooktop—they may melt if left too close to the vent.
- Do not leave any items on the cooktop. The hot air from the vent may ignite flammable items and will increase pressure in closed containers, which may cause them to burst.
- Metal items will become very hot if they are left on the cooktop, and could cause burns.

## Upper Oven Light

Touch the **OVEN LIGHT** pad to turn the light on or off.

## Using the upper oven.

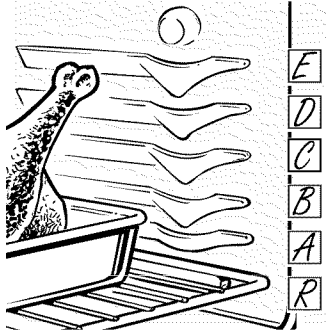

The oven has a special low shelf (R) position just above the oven bottom. Use it when extra cooking space is needed, for example, when cooking a large turkey. The shelf is not designed to slide out at this position.

### How to Set the Upper Oven for Baking or Roasting

- 1 Touch the **BAKE** pad.
- 2 Touch the number pads to set the desired temperature.
- 3 Touch the **START** pad.  
The word **ON** and **100°** will be displayed. As the oven heats up, the display will show the changing temperature. When the oven reaches the temperature you set, a tone will sound.

To change the oven temperature during BAKE cycle, press the BAKE pad and then the number pads to get the new temperature.

- 4 Check food for doneness at minimum time on recipe. Cook longer if necessary.
- 5 Touch the **CLEAR/OFF** pad when cooking is complete.

Type of Food	Shelf Position
Frozen pies (on cookie sheet)	C
Angel food cake	A
Bundt or pound cakes	C
Biscuits, muffins, brownies, cookies, cupcakes, layer cakes, pies	B or C
Casseroles	B or C
Turkey	R or A
Roasting	A or B

### Preheating and Pan Placement

Preheat the oven if the recipe calls for it. To preheat, set the oven at the correct temperature. Preheating is necessary when baking cakes, cookies, pastry and breads.

For ovens without a preheat indicator light or tone, preheat 10 minutes.

Baking results will be better if baking pans are centered in the oven as much as possible. Pans should not touch each other or the walls of the oven. If you need to use two shelves, stagger the pans so one is not directly above the other, and leave approximately 1½" between pans, from the front, back and sides of the wall.

### Aluminum Foil

Do not use aluminum foil on the bottom of the oven.

Do not use aluminum foil to catch spillovers when using the CircuWave fan. The foil will be sucked toward the convection fan.

Never entirely cover a shelf with aluminum foil. This will disturb the heat circulation and result in poor baking.

A smaller sheet of foil may be used to catch a spillover by placing it on a lower shelf several inches below the food.

### Oven Moisture

As your oven heats up, the temperature change of the air in the oven may cause water droplets to form on the door glass. These droplets are harmless and will evaporate as the oven continues to heat up.

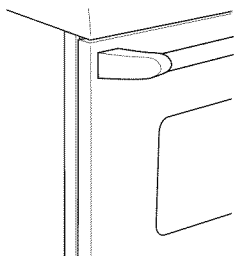

Close the door. Always broil with the door closed.

NOTE: Broil will not work if the temperature probe is plugged in.

### How to Set the Upper Oven for Broiling—Close the oven door

- 1 Place the meat or fish on a broiler grid in a broiler pan.
- 2 Follow suggested shelf positions in the *Broiling Guide*.
- 3 The oven door **must** be closed during broiling.
- 4 Touch the **BROIL HI/LO** pad once for **HI Broil**.
 

To change to **LO Broil**, touch the **BROIL HI/LO** pad again.
- 5 Touch the **START** pad.
 

NOTE: The display will always automatically remind you to close the door.
- 6 When broiling is finished, touch the **CLEAR/OFF** pad.
 

Serve the food immediately, and leave the pan outside the oven to cool during the meal for easiest cleaning.

Use **LO Broil** to cook foods such as poultry or thick cuts of meat thoroughly without over-browning them.

### Broiling Guide

The size, weight, thickness, starting temperature and your preference of doneness will affect broiling times. This guide is based on meats at refrigerator temperature.

†The U.S. Department of Agriculture says "Rare beef is popular, but you should know that cooking it to only 140°F means some food poisoning organisms may survive." (Source: *Safe Food Book, Your Kitchen Guide*, USDA Rev. June 1985.)

Food	Quantity and/or Thickness	Shelf Position	First Side Time (min.)	Second Side Time (min.)	Comments
Ground Beef	1 lb. (4 patties)	C	13	8	Space evenly.
	½ to ¾" thick 4 lbs. (16 patties)	C	15	11	
Beef Steaks	Rare†	E	6	4	Steaks less than ¾" thick are difficult to cook rare. Slash fat.
	Medium	D	8	6	
	Well Done	D	10	8	
	Rare†	C	10	8	
Medium	1½" thick	C	10	8	
	2 to 2½ lbs.	C	15	10-12	
Well Done		D	20	20	
		D	20	20	
Chicken	1 whole cut up	B	25	25	Brush each side with melted butter. Broil skin-side-down first.
	2 to 2½ lbs., split lengthwise Breast	B	25	15	
Bakery Product	Bread (toast)	D	3	1	Space evenly. Place English muffins cut-side-up and brush with butter if desired.
	English Muffin	E	3-4		
Lobster Tails	2-4	B	18-20	Do not turn over.	Cut through back of shell. Spread open. Brush with melted butter before broiling and after half of broiling time.
Fish Fillets	1 lb. (¼ to ½" thick)	D	5	5	Handle and turn very carefully. Brush with lemon butter before and during cooking, if desired.
Salmon Steaks	2 (1" thick)	D	10	5	Turn carefully. Do not turn skin side down.
	2 (½ to ¾" thick)	D	10		
Ham Slices (precooked)	½" thick	C	6	6	
	1" thick	C	8	8	
Pork Chops Well Done	2 (½" thick)	C	10	10	Slash fat.
	2 (1" thick) about 1 lb.	C	15	15	
Lamb Chops	Medium	D	7	4	Slash fat.
	Well Done	D	10	9	
	Medium	D	9	6	
	Well Done	D	14	10	

## Using the clock and timer.

Not all features are on all models.

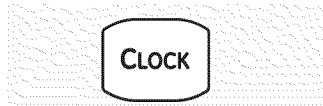

Make sure the clock is set to the correct time of day.

### To Set the Clock

The clock must be set to the correct time of day for the automatic oven timing functions to work properly. The time of day cannot be changed during a timed baking or self-cleaning cycle.

- 1 Touch the **CLOCK** pad.
- 2 Touch the number pads.

Touch the number pads the same way you read them. For example, to set 12:34, touch the number pads **1, 2, 3** and **4** in that order.

If number pads are not touched within one minute after you touch the **CLOCK** pad, the display reverts to the original setting. If this happens, touch the **CLOCK** pad and reenter the time of day.

- 3 Touch the **START** pad until the time of day shows in the display. This enters the time and starts the clock.

To check the time of day when the display is showing other information, simply touch the **CLOCK** pad. The time of day shows until another pad is touched.

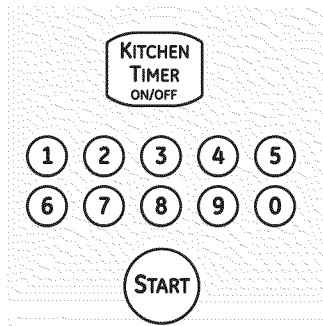

The timer is a minute timer only.

The **CLEAR/OFF** pad does not affect the timer.

### To Set the Timer

The timer does not control oven operations. The maximum setting on the timer is 9 hours and 59 minutes.

- 1 Touch the **KITCHEN TIMER ON/OFF** pad.
- 2 Touch the number pads until the amount of time you want shows in the display. The maximum number of minutes that can be entered is 60. To set additional time, you will need to set it by hours and minutes. For example, to enter 1 hour and 30 minutes, touch **1, 3** and **0** in that order.

If you make a mistake, press the **KITCHEN TIMER ON/OFF** pad and begin again.

- 3 Touch the **START** pad. After pressing the **START** pad, **SET** disappears; this tells you the time is counting down, although the display does not change until one minute has passed.
- 4 When the timer reaches **:00**, the control will beep 3 times followed by one beep every 6 seconds until the **KITCHEN TIMER ON/OFF** pad is touched.

The 6 second tone can be canceled by following the steps in the Special features of your oven control section under Tones at the End of a Timed Cycle.

### To Reset the Timer

If the display is still showing the time remaining, you may change it by touching the **KITCHEN TIMER ON/OFF** pad; then touch the number pads until the time you want appears in the display.

If the remaining time is not in the display (clock, delay start or cooking time are in the display), recall the remaining time by touching the **KITCHEN TIMER ON/OFF** pad and then touching the number pads to enter the new time you want.

### To Cancel the Timer

Touch the **KITCHEN TIMER ON/OFF** pad twice.

### Power Outage

If a flashing time is in the display, you have experienced a power failure. Reset the clock.

To reset the clock, touch the **CLOCK** pad. Enter the correct time of day by touching the appropriate number pads. Touch the **START** pad.



# Using the timed baking and roasting features (upper oven only).

**NOTE:** Foods that spoil easily—such as milk, eggs, fish, stuffings, poultry and pork—should not be allowed to sit for more than 1 hour before or after cooking. Room temperature promotes the growth of harmful bacteria. Be sure that the oven light is off because heat from the bulb will speed harmful bacteria growth.

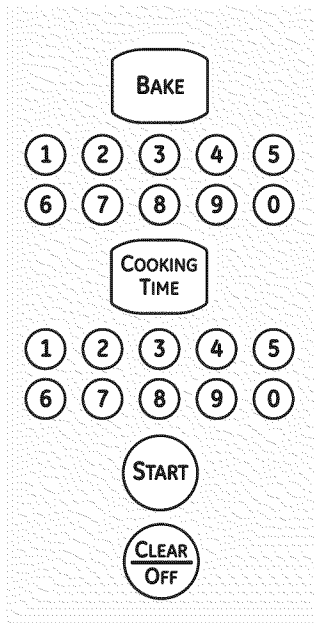

## How to Set an Immediate Start and Automatic Stop

The upper oven will turn on immediately and cook for a selected length of time. At the end of the cooking time, the oven will turn off automatically.

- 1 Touch the **BAKE** pad.
- 2 Using the number pads, enter the desired temperature.
- 3 Touch the **COOKING TIME** pad.

**NOTE:** If your recipe requires preheating, you may need to add additional time to the length of the cooking time.

- 4 Using the number pads, enter the desired baking time. The oven temperature and the cooking time that you entered will be displayed.
- 5 Touch the **START** pad.

The word **ON** and **100°** will be displayed. The cook time will begin to count down. As the oven heats up, the display will show the changing temperature. When the oven reaches the temperature you set, 3 beeps will sound.

At the end of timed baking, the oven will turn off. The end of cycle tone will sound.

Touch the **CLEAR/OFF** pad to clear the display.

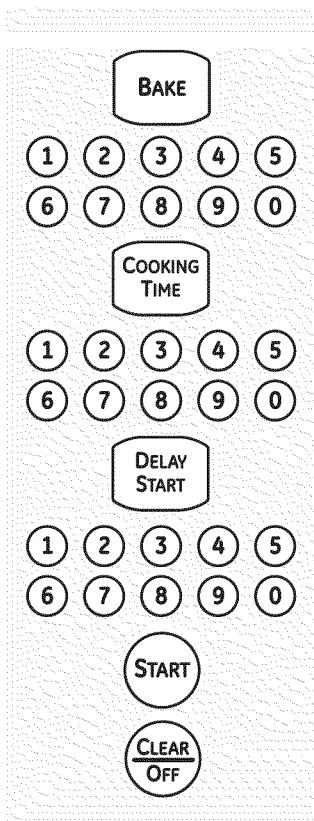

## How to Set a Delayed Start and Automatic Stop

You can set the upper oven control to delay-start the oven, cook for a specific length of time and then turn off automatically.

Make sure the clock shows the correct time of day.

- 1 Touch the **BAKE** pad.
- 2 Using the number pads, enter the desired temperature.
- 3 Touch the **COOKING TIME** pad.

**NOTE:** If your recipe requires preheating, you may need to add additional time to the length of the cooking time.

- 4 Using the number pads, enter the desired baking time.
- 5 Touch the **DELAY START** pad.
- 6 Using the number pads, enter the time of day you want the oven to turn on and start cooking.
- 7 Touch the **START** pad.

**NOTE:** An attention tone will sound if you are using timed baking and do not touch the **START** pad after entering the baking temperature.

If you would like to check the times you have set, touch the **DELAY START** pad to check the start time you have set or touch the **COOKING TIME** pad to check the length of cooking time you have set.

The oven will turn on automatically. The word **ON** and **100°** will be displayed. The cook time will begin to count down.

As the oven heats up, the display will show the changing temperature. The oven will cook for the programmed cooking time and shut off automatically.

At the end of timed baking, the oven will turn off. The end of cycle tone will sound.

Touch the **CLEAR/OFF** pad to clear the display.

## Using the probe.

For many foods, especially roasts and poultry, internal food temperature is the best test for doneness. The temperature probe takes the guesswork out of roasting by cooking foods to the exact doneness you want.

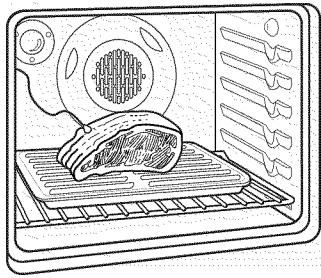

The temperature probe has a skewer-like probe at one end and a plug at the other end that goes into the outlet in the oven.

Use of probes other than the one provided with this product may result in damage to the probe.

Use the handles of the probe and plug when inserting and removing them from the food and outlet.

- To avoid damaging your probe, do not use tongs to pull on the cable when removing it.
- To avoid breaking the probe, make sure food is completely defrosted before inserting.
- To prevent possible burns, do not unplug the probe from the outlet until the oven has cooled.

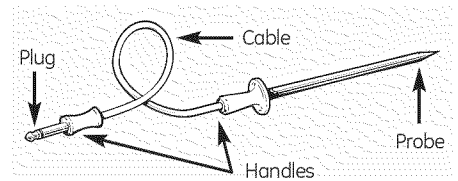

- Never leave your probe inside the oven during a self-cleaning cycle.
- Do not store the probe in the oven.

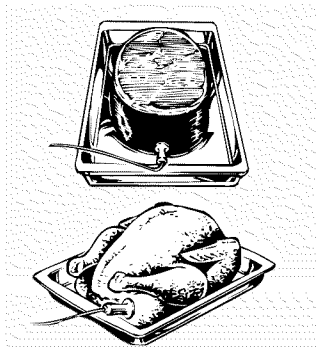

After preparing the meat and placing it on a trivet or on a broiler pan grid, follow these directions for proper probe placement.

Insert the probe completely into the meat. It should not touch the bone, fat or gristle.

For roasts with no bone, insert the probe into the meatiest part of the roast. For bone-in ham or lamb, insert the probe into the center of the lowest large muscle.

Insert the probe into the center of dishes such as meat loaf or casseroles.

Insert the probe into the meatiest part of the inner thigh from below and parallel to the leg of a whole turkey.

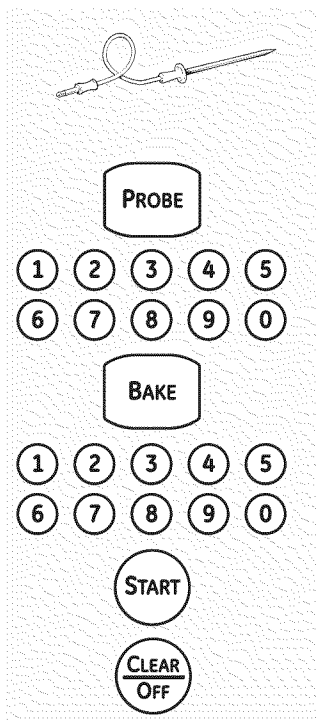

### How to Set the Upper Oven For Roasting When Using the Probe

- 1 Insert the probe into the food.
- 2 Plug the probe into the outlet in the oven. Make sure it's pushed all the way in. Close the oven door.
- 3 Touch the **PROBE** pad.
- 4 Touch the number pads to set the desired internal food or meat temperature.
- 5 Touch the **BAKE** pad.
- 6 Touch the number pads to set the desired oven temperature.
- 7 Touch the **START** pad.

The display will flash if the probe is inserted into the outlet and you have not set a probe temperature and touched the **START** pad.

After the internal temperature of the food reaches 100°F, the changing internal temperature will be shown in the display.

- 8 When the internal temperature of the food reaches the number you have set, the probe and the oven turn off and the oven control signals. To stop the signal, touch the **CLEAR/OFF** pad. Use hot pads to remove the probe from the food. Do not use tongs to pull on it—they might damage it.

To change the oven temperature during the Roast cycle, touch the **BAKE** pad and then the number pads to set the new temperature.

- If the probe is removed from the food before the final temperature is reached, a tone will sound and the display will flash until the probe is removed from the oven.

- You can use the timer even though you cannot use timed oven operations while using the probe.

# Using the convection oven.

The convection oven fan shuts off when the oven door is opened. DO NOT leave the door open for long periods of time while using convection cooking.

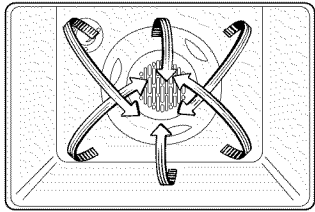

In a convection oven, a fan circulates hot air over, under and around the food. This circulating hot air is evenly distributed throughout the oven cavity. As a result, foods are evenly cooked and browned—often in less time than with regular heat.

NOTE: To maximize cooking evenness, the fan is designed to rotate in both directions with a pause in between. This is normal.

To help you understand the difference between convection bake and roast and traditional bake and roast, here are some general guidelines.

## Convection Bake

- Preheat the oven. See the Using the Oven—Preheating and Pan Placement section.
- Ideal for foods cooked on multiple shelves.
- Good for large quantities of baked foods.
- Good results with cookies, biscuits, brownies, cupcakes, cream puffs, sweet rolls, angel food cake and bread.

The convection fan circulates the heated air evenly over and around the food.

## Convection Roast

- Good for large tender cuts of meat, uncovered.

The convection fan circulates the heated air evenly over and around the food. Meat and poultry are browned on all sides as if they were cooked on a rotisserie. Heated air will be circulated over, under and around the food being roasted. The heated air seals in juices quickly for a moist and tender product while, at the same time, creating a rich golden brown exterior.

Roasts or poultry should be cooked on shelf position (A).

When you are convection roasting, it is important that you use a broiler pan and grid for best convection roasting results. The pan is used to catch grease spills and the grid is used to prevent grease splatters.

- Place the shelf in shelf position (A).

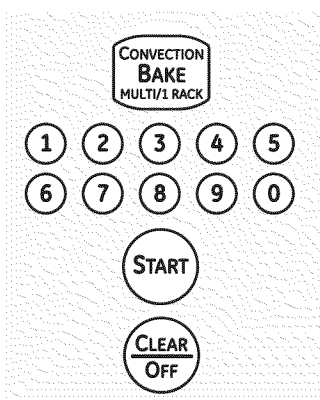
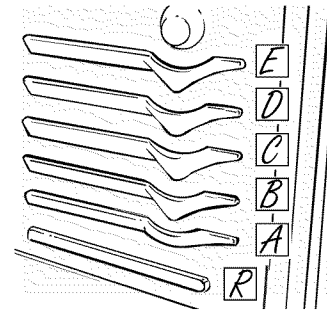

## Auto Recipe™ Conversion

You can use your favorite recipes in the convection oven.

When using CONVECTION BAKE, the oven will automatically convert the oven temperature from regular baking to Convection Bake temperatures.

- 1 Using the number pads, enter the temperature recommended in the recipe.
- 2 Touch the **START** pad.

The display will show the temperature you entered from your recipe. The oven will automatically convert it to the convection cooking temperature.

- 3 Touch the **CLEAR/OFF** pad when baking is finished.

- Use pan size recommended in the recipe.
- Some package instructions for frozen casseroles, main dishes or baked goods have been developed using commercial convection ovens. For best results in this oven, preheat the oven and use the temperature, for regular baking, on the package.

## Using the convection oven.

### Cookware for Convection Cooking

Before using your convection oven, check to see if your cookware leaves room for air circulation in the oven. If you are baking with several pans, leave space between them. Also, be sure the pans do not touch each other or the walls of the oven.

### Paper and Plastic

Heat-resistant paper and plastic containers that are recommended for use in regular ovens can be used in convection ovens. Plastic cookware that is heat-resistant to temperatures of 400°F can also be used, when oven is below 400°F.

### Metal and Glass

Any type of cookware will work in your convection oven. However, metal pans heat the fastest and are recommended for convection baking.

■ *Darkened or matte-finished pans will bake faster than shiny pans.*

■ *Glass or ceramic pans cook more slowly.*

When baking cookies, you will get the best results if you use a flat cookie sheet instead of a pan with low sides.

For recipes like oven-baked chicken, use a pan with low sides. Hot air cannot circulate well around food in a pan with high sides.

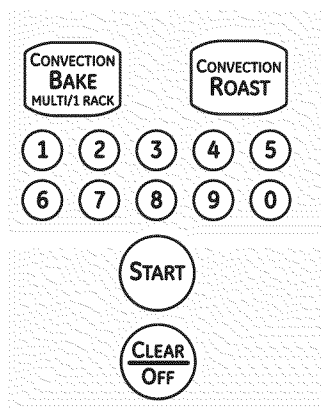

### How to Set the Upper Oven for Convection Baking or Roasting

**1** Touch the **CONVECTION BAKE MULTI/1 RACK** pad once for multi-rack convection baking. This mode is used for cooking food items on more than one rack (i.e., 2, 3 or more racks) at the same time in convection bake. See the *Multi-Shelf Baking* section for more information. Touch the **CONVECTION BAKE MULTI/1 RACK** pad twice for one rack convection baking. This mode is used for cooking food items on only one rack in convection bake.

Touch the **CONVECTION ROAST** pad for convection roasting.

**2** Touch the number pads to set the desired oven temperature. Remember to adjust baking temperature accordingly. See the *Adapting Recipes* section.

**3** Touch the **START** pad.

To change the oven temperature, touch the **CONVECTION BAKE** or **CONVECTION ROAST** pad and then the number pads to set the new temperature.

When the oven starts to heat the changing temperature, starting at 100°F, will be displayed. When the oven reaches the temperature you set, 3 beeps will sound.

**4** Touch the **CLEAR/OFF** pad when finished.

**NOTE:** You will hear a fan while cooking with convection. The fan will stop when the door is opened but the heat will not turn off.

The fan will not start until the preheat temperature is reached.

In convection bake modes, for maximum cooking evenness, the fan is designed to rotate in both directions, with a pause in between. This is normal.

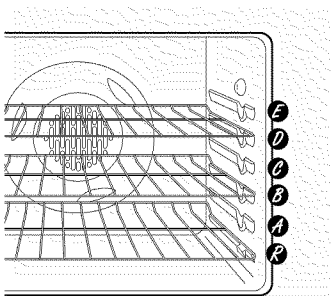

### Multi-Shelf Baking

Because heated air is circulated evenly throughout the oven, foods can be baked with excellent results using multiple shelves.

Multi-shelf baking may increase cook times slightly for some foods but the overall result is time saved. Cookies, muffins, biscuits, and other quick breads give very good results with multi-shelf baking.

To cook food on more than one rack in convection bake, use **CONVECTION BAKE MULTI**.

When baking larger foods on 3 shelves, place one shelf in the 2nd (A) position, one on the 4th (C) position and the third shelf in the 6th (E) position.

When baking cookies, place the shelves in the 3rd (B), 4th (C) and 5th (D) positions.

When convection baking with only 1 shelf, follow the shelf positions recommended in the *Using the Oven* section.

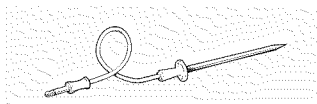

For best results when roasting large turkeys and roasts, we recommend using the probe included in the convection oven.

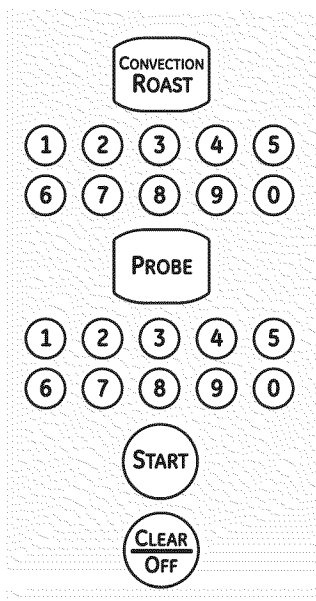

## How to Set the Upper Oven for Convection Roasting when Using the Probe

The display will flash **PROBE** and the oven control will signal if the probe is inserted into the outlet, and you have not set a probe temperature and touched the **START** pad.

- 1 Place the shelf in the shelf position (A). Insert the probe completely into the food.
- 2 Plug the probe into the outlet in the oven. Make sure it is pushed all the way in. Close the oven door.
- 3 Touch the **CONVECTION ROAST** pad.
- 4 Touch the number pads to set the desired oven temperature.
- 5 Touch the **PROBE** pad.
- 6 Touch the number pads to set the desired internal food temperature.

To change the oven temperature during the Convection Roast cycle, touch the **CONVECTION ROAST** pad and then touch the number pads to set the new desired temperature.

- 7 Touch the **START** pad.

When the oven starts to heat, the word **LO** will be in the display.

After the internal temperature of the food reaches 100°F, the changing internal temperature will be shown in the display.

- 8 When the internal temperature of the food reaches the number you have set, the probe and the oven turn off and the oven control signals. To stop the signal, touch the **CLEAR/OFF** pad. Use hot pads to remove the probe from the food. Do not use tongs to pull on it—they might damage it.

**CAUTION:** To prevent possible burns, do not unplug the probe from the oven outlet until the oven has cooled. Do not store the probe in the oven.

### NOTE:

- If the probe is removed from the food before the final temperature is reached, a tone will sound and the display will flash until the probe is removed from the oven.
- You will hear a fan while cooking with this feature. The fan will stop when the door is opened but the heat will not turn off.
- You can use the timer even though you cannot use timed oven operations while using the probe.

## Using the convection oven.

### Convection Roasting Guide

Meats		Minutes/Lb.	Oven Temp.	Internal Temp.	
<b>Beef</b>	Rib (3 to 5 lbs.)	Rare†	20–24	325°F	140°F
		Medium	24–28	325°F	160°F
		Well	28–32	325°F	170°F
	Boneless Rib, Top Sirloin	Rare†	20–24	325°F	140°F
Medium		24–28	325°F	160°F	
	Well	28–32	325°F	170°F	
	Beef Tenderloin	Rare†	10–14	325°F	140°F
		Medium	14–18	325°F	160°F
	Pot Roast (2½ to 3 lbs.) chuck, rump		35–45	300°F	170°F
<b>Pork</b>	Bone-in (3 to 5 lbs.)		23–27	325°F	170°F
	Boneless (3 to 5 lbs.)		23–27	325°F	170°F
	Pork Chops (½ to 1" thick)	2 chops	30–35 total	325°F	170°F
		4 chops	35–40 total	325°F	170°F
6 chops		40–45 total	325°F	170°F	
<b>Ham</b>	Canned (3 lbs. fully cooked)		14–18	325°F	140°F
	Butt (5 lbs. fully cooked)		14–18	325°F	140°F
	Shank (5 lbs. fully cooked)		14–18	325°F	140°F
<b>Lamb</b>	Bone-in (3 to 5 lbs.)	Medium	17–20	325°F	160°F
		Well	20–24	325°F	170°F
	Boneless (3 to 5 lbs.)	Medium	17–20	325°F	160°F
		Well	20–24	325°F	170°F
<b>Seafood</b>	Fish, whole (3 to 5 lbs.)		30–40 total	400°F	
	Lobster Tails (6 to 8 oz. each)		20–25 total	350°F	
<b>Poultry</b>	Whole Chicken (2½ to 3½ lbs.)		24–26	350°F	180°–185°F
	Cornish Hens Unstuffed (1 to 1½ lbs.)		50–55 total	350°F	180°–185°F
			55–60 total	350°F	180°–185°F
	Duckling (4 to 5 lbs.)		24–26	325°F	180°–185°F
	Turkey, whole*	Unstuffed (10 to 16 lbs.)		8–11	325°F
Unstuffed (18 to 24 lbs.)			7–10	325°F	180°–185°F
Turkey Breast (4 to 6 lbs.)			16–19	325°F	170°F

\* Stuffed birds generally require 30–45 minutes additional roasting time. Shield legs and breast with foil to prevent overbrowning and drying of skin.

† The U.S. Department of Agriculture says "Rare beef is popular, but you should know that cooking it to only 140°F means some food poisoning organisms may survive." (Source: *Safe Food Book. Your Kitchen Guide.* USDA Rev. June 1985.)

# Using the timed convection baking features (upper oven only).

You will hear a fan while cooking with this feature. The fan will stop when the door is opened but the heat will not turn off.

**NOTE:** Foods that spoil easily—such as milk, eggs, fish, stuffings, poultry and pork—should not be allowed to sit for more than 1 hour before or after cooking. Room temperature promotes the growth of harmful bacteria. Be sure that the oven light is off because heat from the bulb will speed harmful bacteria growth.

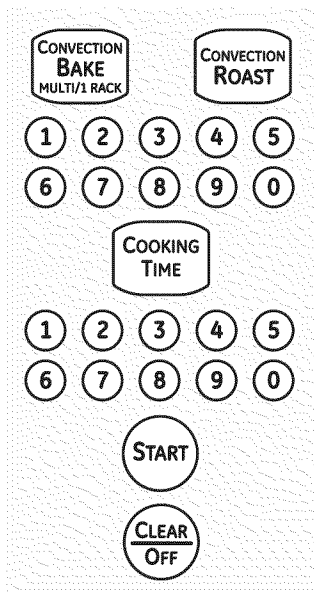

## How to Set an Immediate Start and Automatic Stop

The upper oven will turn on immediately and cook for a selected length of time. At the end of the cooking time, the oven will turn off automatically.

- 1 Touch the **CONVECTION BAKE MULTI/1 RACK** pad once for multi-rack convection baking. This mode is used for cooking food items on more than one rack (i.e., 2, 3 or more racks) at the same time in convection bake. See the *Multi-Shelf Baking* section for more information. Touch the **CONVECTION BAKE MULTI/1 RACK** pad twice for one rack convection baking. This mode is used for cooking food items on only one rack in convection bake. Touch the **CONVECTION ROAST** pad for convection roasting.

- 2 Touch the number pads to set the desired oven temperature.
- 3 Touch the **COOKING TIME** pad.

**NOTE:** If your recipe requires preheating, you may need to add additional time to the length of the cooking time.

- 4 Touch the number pads to set the desired length of cooking time. The minimum cooking time you can set is 1 minute.

The oven temperature that you set and the cooking time that you entered will be in the display.

- 5 Touch the **START** pad.

The display shows the oven temperature that you set and the cooking time countdown. The display starts changing once the temperature reaches 100°F.

- 6 At the end of timed convection bake the oven will turn off. The end of cycle tone will sound. Touch the **CLEAR/OFF** pad to clear the display if necessary.
- 7 Remove the food from the oven. Remember, foods that are left in the oven continue cooking after the controls are off.

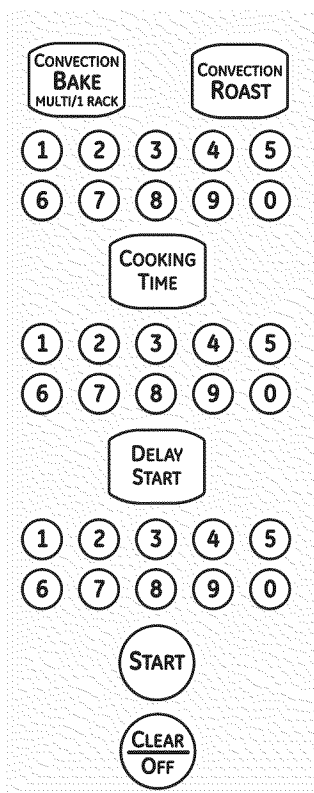

## How to Set a Delayed Start and Automatic Stop

You can set the upper oven control to delay-start the oven, cook for a specific length of time and then turn off automatically.

Make sure the clock shows the correct time of day.

- 1 Touch the **CONVECTION BAKE MULTI/1 RACK** pad once for multi-rack convection baking. This mode is used for cooking food items on more than one rack (i.e., 2, 3 or more racks) at the same time in convection bake. See the *Multi-Shelf Baking* section for more information. Touch the **CONVECTION BAKE MULTI/1 RACK** pad twice for one rack convection baking. This mode is used for cooking food items on only one rack in convection bake.

Touch the **CONVECTION ROAST** pad for convection roasting.

- 2 Touch the number pads to set the desired oven temperature.
- 3 Touch the **COOKING TIME** pad.

**NOTE:** If your recipe requires preheating, you may need to add additional time to the length of the cooking time.

- 4 Touch the number pads to set the desired cooking time.

- 5 Touch the **DELAY START** pad.

- 6 Touch the number pads to set the time of day you want the oven to turn on and start cooking.

If you would like to check the times you have set, touch the **DELAY START** pad to check the start time you have set or touch the **COOKING TIME** pad to check the length of cooking time you have set.

- 7 Touch the **START** pad.

**NOTE:** An attention tone will sound if you are using timed baking and do not touch the **START** pad after entering the baking temperature.

When the oven turns on at the time of day you have set, the display will show the changing temperature (starting at 100°F) and the cooking time countdown.

At the end of timed convection bake the oven will turn off. The end of cycle tone will sound.

- 8 Touch the **CLEAR/OFF** pad to clear the display if necessary. When baking is finished, remove the food from the oven. Remember, even though the oven shuts off automatically, foods continue cooking after the controls are off.

## Special features of your upper oven control.

Your new touch pad control has additional features that you may choose to use. The following are the features and how you may activate them.

The special feature modes can only be activated while the display is showing the time of day. They remain in the control's memory until the steps are repeated.

When the display shows your choice, touch the **START** pad. The special features will remain in memory after a power failure.

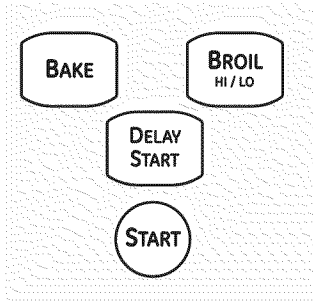

### 12 Hour Shut-Off

With this feature, should you forget and leave the oven on, the control will automatically turn off the oven after 12 hours during baking functions or after 3 hours during a broil function.

If you wish to turn **OFF** this feature, follow the steps below.

- 1 Touch the **BAKE** and **BROIL HI/LO** pads at the same time for 3 seconds until the display shows **SF**.

- 2 Touch the **DELAY START** pad. The display will show **12 shdn** (12 hour shut-off). Touch the **DELAY START** pad again and the display will show **no shdn** (no shut-off).
- 3 Touch the **START** pad to activate the no shut-off and leave the control set in this special features mode.

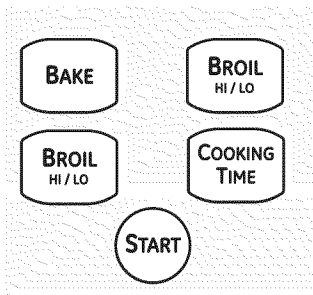

### Fahrenheit or Celsius Temperature Selection

Your oven control is set to use the Fahrenheit temperature selections but you may change this to use the Celsius selections.

- 1 Touch the **BAKE** and **BROIL HI/LO** pads at the same time for 3 seconds until the display shows **SF**.

- 2 Touch the **BROIL HI/LO** pad. The display will show **F** (Fahrenheit).
- 3 Touch the **BROIL HI/LO** pad again. The display will show **C** (Celsius).
- 4 Touch the **START** pad.

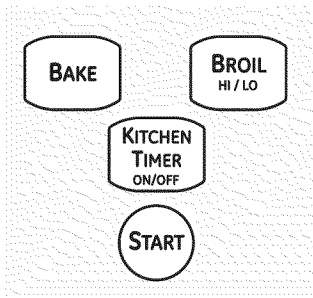

### Tones at the End of a Timed Cycle

At the end of a timed cycle, 3 short beeps will sound followed by one beep every 6 seconds until the **CLEAR/OFF** pad is touched. This continual 6 second beep may be canceled.

To cancel the 6 second beep:

- 1 Touch the **BAKE** and **BROIL HI/LO** pads at the same time for 3 seconds until the display shows **SF**.

- 2 Touch the **KITCHEN TIMER ON/OFF** pad. The display shows **CON BEEP** (continual beep). Touch the **KITCHEN TIMER ON/OFF** pad again. The display shows **BEEP**. (This cancels the one beep every 6 seconds.)
- 3 Touch the **START** pad.





### Gas/Control Lockout (on some models)

Your control will allow you to lock out the surface burners, oven burners and control panel so they cannot be activated.

To lock/unlock the controls:

- 1 Turn all surface burners off.
- 2 Touch and hold the **GAS/CONTROL LOCKOUT** pad for 3 seconds until the display shows **LOC**.
- 3 To unlock the control, touch and hold the **GAS/CONTROL LOCKOUT** pad for 3 seconds until **LOC** disappears from the display.

When this feature is on and the touch pads are touched, the control will beep and the display will show **LOC**.

- The control lock-out mode affects all controls. No controls will work when this feature is activated.
- The adjustment will be retained in memory after a power failure.

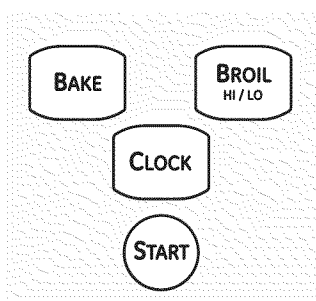

### 12 Hour, 24 Hour or Clock Black-Out

Your control is set to use a 12 hour clock.

If you would prefer to have a 24 hour military time clock or black-out the clock display, follow the steps below.

- 1 Touch the **BAKE** and **BROIL HI/LO** pads at the same time for 3 seconds until the display shows **SF**.
- 2 Touch the **CLOCK** pad once. The display will show **12 hr**. If this is the choice you want, touch the **START** pad.

Touch the **CLOCK** pad again to change to the 24 hour military time clock. The display will show **24 hr**. If this is the choice you want, touch the **START** pad.

Touch the **CLOCK** pad again to black-out the clock display. The display will show **OFF**. If this is the choice you want, touch the **START** pad.

**NOTE:** If the clock is in the black-out mode you will not be able to use the Delay Start function.

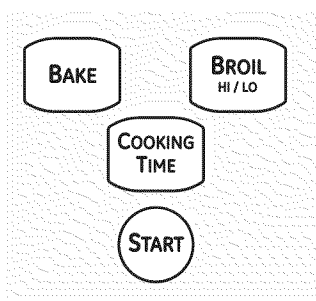

### Cook and Hold

Your new control has a cook and hold feature that keeps cooked foods warm for up to 3 hours after the cooking function is finished.

This feature can only be used when timed cooking.

To activate this feature, follow the steps below.

- 1 Touch the **BAKE** and **BROIL HI/LO** pads at the same time for 3 seconds until the display shows **SF**.

- 2 Touch the **COOKING TIME** pad. The display will show **Hld OFF**.

Touch the **COOKING TIME** pad again to activate the feature. The display will show **Hld ON**.

- 3 Touch the **START** pad to activate the cook and hold feature and leave the control set in this special features mode.

## Using the Sabbath Feature. (on some models)

(Designed for use on the Jewish Sabbath and Holidays)

The Sabbath feature can be used for baking/roasting in the upper oven only. It cannot be used for convection, broiling, self-cleaning, or Delay Start cooking.

**NOTE:** The oven light comes on automatically when the door is opened and goes off when the door is closed. The bulb may be removed. See the Oven Light Replacement section.

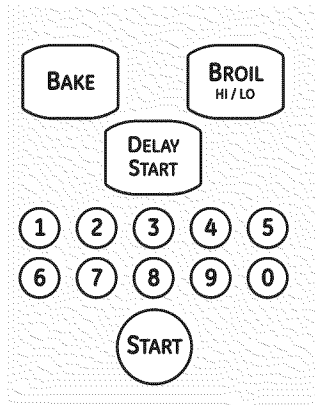

When the display shows  $\square$  the oven is set in Sabbath. When the display shows  $\square \square$  the oven is baking/roasting.

### How to Set for Regular Baking/Roasting

Make sure the clock shows the correct time of day and the oven is off.

- 1 Press and hold **both** the **BAKE** and **BROIL HI/LO** pads, **at the same time**, until the display shows **SF**.
- 2 Tap the **DELAY START** pad until **Sab bAtH** appears in the display.
- 3 Touch the **START** pad and  $\square$  will appear in the display.
- 4 Touch the **BAKE** pad. No signal will be given.
- 5 Using the number pads, enter the desired temperature between 170° and 550°. No signal or temperature will be given.

- 6 Touch the **START** pad.
- 7 After a random delay period of approximately 30 seconds to 1 minute,  $\square \square$  will appear in the display indicating that the oven is baking/roasting. If  $\square \square$  doesn't appear in the display, start again at Step 4.

To adjust the oven temperature, touch the **BAKE** pad, enter the new temperature using the number pads, and touch the **START** pad.

**NOTE:** The **CLEAR/OFF** and **COOKING TIME** pads are active during the Sabbath feature.

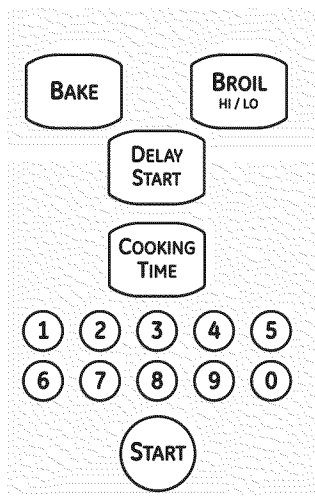

When the display shows  $\square$  the oven is set in Sabbath. When the display shows  $\square \square$  the oven is baking/roasting.

### How to Set for Timed Baking/Roasting—Immediate Start and Automatic Stop

Make sure the clock shows the correct time of day and the oven is off.

- 1 Press and hold **both** the **BAKE** and **BROIL HI/LO** pads, **at the same time**, until the display shows **SF**.
- 2 Tap the **DELAY START** pad until **Sab bAtH** appears in the display.
- 3 Touch the **START** pad and  $\square$  will appear in the display.
- 4 Touch the **COOKING TIME** pad.
- 5 Touch the number pads to set the desired length of cooking time between 1 minute and 9 hours and 99 minutes. The cooking time that you entered will be displayed.
- 6 Touch the **START** pad.
- 7 Touch the **BAKE** pad. No signal will be given.

- 8 Using the number pads, enter the desired temperature. No signal or temperature will be given.

- 9 Touch the **START** pad.
- 10 After a random delay period of approximately 30 seconds to 1 minute,  $\square \square$  will appear in the display indicating that the oven is baking/roasting. If  $\square \square$  doesn't appear in the display, start again at Step 7.

To adjust the oven temperature, touch the **BAKE** pad, enter the new temperature using the number pads, and touch the **START** pad.

When cooking is finished, the display will change from  $\square \square$  to  $\square$  and **0:00** will appear, indicating that the oven has turned **OFF** but is still set in Sabbath. Remove the cooked food.

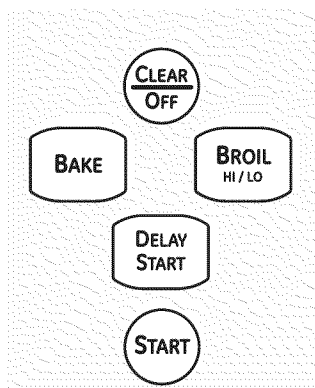

### How to Exit the Sabbath Feature

- 1 Touch the **CLEAR/OFF** pad.
- 2 If the oven is cooking, wait for a random delay period of approximately 30 seconds to 1 minute, until only  $\square$  is in the display.
- 3 Press and hold **both** the **BAKE** and **BROIL HI/LO** pads, **at the same time**, until the display shows **SF**.
- 4 Tap the **DELAY START** pad until **12 shdn** or **no shdn** appears in the display.

**12 shdn** indicates that the oven will automatically turn off after 12 hours.  
**no shdn** indicates that the oven will not automatically turn off.

- 5 Touch the **START** pad.

**NOTE:** If a power outage occurred while the oven was in Sabbath, the oven will automatically turn off and stay off even when the power returns. The oven control must be reset.

## Adjust the upper oven thermostat—Do it yourself!

ge.com

You may find that your new oven cooks differently than the one it replaced. Use your new oven for a few weeks to become more familiar with it. If you still think your new oven is too hot or too cold, you can adjust the thermostat yourself.

Do not use thermometers, such as those found in grocery stores, to check the temperature setting of your oven. These thermometers may vary 20–40 degrees.

**NOTE:** This adjustment will not affect the broiling or the self-cleaning temperatures. The adjustment will be retained in memory after a power failure.

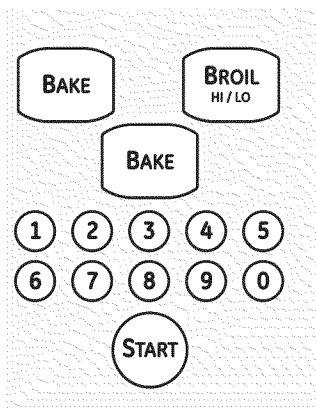

### To Adjust the Thermostat

- 1 Touch the **BAKE** and **BROIL HI/LO** pads at the same time for 3 seconds until the display shows **SF**.
- 2 Touch the **BAKE** pad. A two digit number shows in the display.  
Touch **BAKE** once to decrease (-) the oven temperature, or twice to increase (+).
- 3 The oven temperature can be adjusted up as much as 35°F or down as much as 35°F. Touch the number pads the same way you read them. For example, to change the oven temperature 15°F, touch **1** and **5**.
- 4 When you have made the adjustment, touch the **START** pad to go back to the time of day display. Use your oven as you would normally.

**NOTE:** The thermostat adjustment for Baking will also affect Convection Baking or Convection Roasting.

## The type of margarine will affect baking performance!

Most recipes for baking have been developed using high fat products such as butter or margarine (80% fat). If you decrease the fat, the recipe may not give the same results as with a higher fat product.

Recipe failure can result if cakes, pies, pastries, cookies or candies are made with low-fat spreads. The lower the fat content of a spread product, the more noticeable these differences become.

Federal standards require products labeled "margarine" to contain at least 80% fat by weight. Low-fat spreads, on the other hand, contain less fat and more water. The high moisture content of these spreads affects the texture and flavor of baked goods. For best results with your old favorite recipes, use margarine, butter or stick spreads containing at least 70% vegetable oil.

## Using the lower oven drawer.

The lower oven drawer may be used to bake foods using the same times and temperatures as a standard oven. Foods ideal for baking in the lower oven drawer include pizza, frozen foods, casseroles, biscuits, rolls and many desserts.

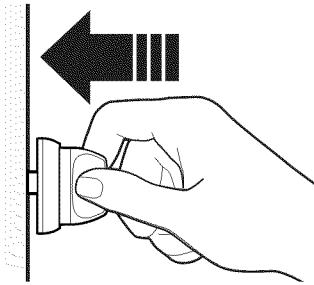
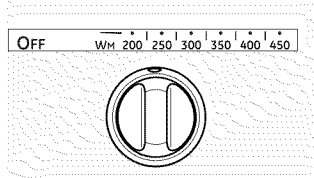

Push in and turn the lower oven drawer knob to any desired setting.

### To Use the Lower Oven Drawer

- 1 Push in and turn the lower oven drawer knob to any desired setting.
- 2 Allow the lower oven drawer to preheat.
  - The ON signal light is located on the upper right side of the knob and glows when the knob is in the ON position. It remains ON until the knob is moved to the OFF position.
  - The "Heating" signal light is located below the ON signal light and glows when the heating elements are active. Preheat is complete after the "Heating" signal has turned off for the first time with each use.

### NOTES:

- Always use the included drawer rack when using the Lower Oven Drawer.
- The lower oven drawer cannot be used during a self-clean cycle of the upper oven.
- Do not put food, foil or cookware directly on the bottom of the lower oven drawer. Always use the included drawer rack.
- If foods require a cover, use only foil or lids able to withstand baking temperatures. Do not use plastic.
- Maximum height of foods that can be placed in the lower oven drawer is 4".
- Do not put liquid or water in the lower oven drawer.
- Never place plastics, paper, canned foods or combustible material in the lower oven drawer.

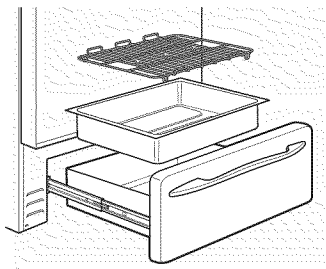

The lower oven drawer uses less energy than the upper oven. Allow the following approximate times for preheating:

Desired Lower Oven Temperature	Preheat Time
WARM	10 minutes
350°F	20 minutes
425°F	30 minutes

## Adjust the oven thermostat—Do it yourself!

You may find that your new oven cooks differently than the one it replaced. Use your new oven for a few weeks to become more familiar with it. If you still think your new oven is too hot or too cold, you can adjust the thermostat yourself.

Do not use thermometers, such as those found in grocery stores, to check the temperature setting of your oven. These thermometers may vary 20–40 degrees.

**NOTE:** This adjustment will not affect the broiling temperatures.

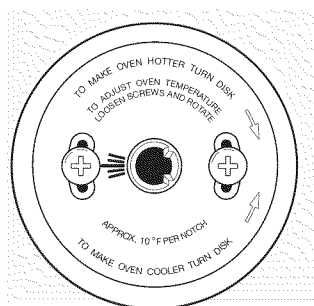

Back of Lower Oven Knob  
(Appearance may vary.)

- 1 Pull the **OVEN CONTROL** knob off the range and look at the back side. To make an adjustment, loosen (approximately one turn), but do not completely remove, the two screws on the back of the knob.
- 2 With the back of the knob facing you, hold the outer edge of the knob with one hand and turn the front of the knob with the other hand.
  - To raise the oven temperature, move the top screw toward the right. You'll hear a click for each notch you move the knob.
  - To lower the temperature, move the top screw toward the left.

Each click will change the oven temperature approximately 10°F. (Range is ± 60°F. from the arrow.) We suggest that you make the adjustment one click from the original setting and check oven performance before making any additional adjustments.

- 3 After the adjustment is made, retighten screws so they are snug, but be careful not to overtighten.
- 4 Re-install knob on range and check performance.

# Using the self-cleaning upper oven.

The oven door must be closed and all controls set correctly for the cycle to work properly.

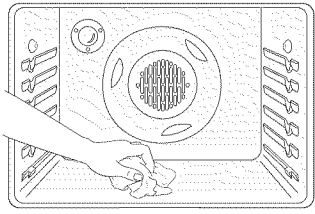

Wipe up heavy soil on the oven bottom.

## Before a Clean Cycle

For the first self-clean cycle, we recommend venting your kitchen with an open window or using a ventilation fan or hood.

Remove the shelves, any broiler pan, broiler grid, probe, all cookware and any aluminum foil from the oven.

The oven shelves can be self-cleaned, but they will darken, lose their luster and become hard to slide.

Soil on the front frame of the range and outside the gasket on the door will need to be cleaned by hand. Clean these areas with hot water, soap-filled scouring pads or cleansers such as Soft Scrub®. Rinse well with clean water and dry.

Do not clean the gasket. The fiberglass material of the oven door gasket cannot withstand abrasion. It is essential for the gasket to remain intact. If you notice it becoming worn or frayed, replace it.

Wipe up any heavy spillovers on the oven bottom.

Make sure the oven light bulb cover is in place and the oven light is off.

**IMPORTANT:** The health of some birds is extremely sensitive to the fumes given off during the self-cleaning cycle of any range. Move birds to another well-ventilated room.

**NOTE:** Use caution when opening the upper oven after the self-clean cycle has ended. The oven may still be hot.

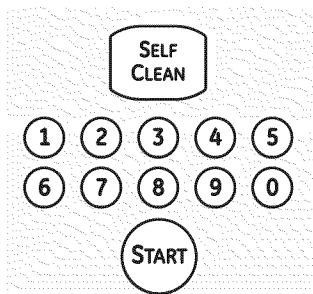

## How to Set the Upper Oven for Cleaning

**NOTE:** The surface burners must be turned off prior to the self-clean start time.

1 Touch the **SELF CLEAN** pad.

**NOTE:** If the display shows **LOC**, touch and hold the **GAS/CONTROL LOCKOUT** pad for 3 seconds to turn it off. See the *Gas/Control Lockout* section.

2 Using the number pads, enter the desired clean time, if a time other than 4 hours is needed.

Clean cycle time is normally 4 hours. You can change the clean time to any time between 3 hours and 5 hours, depending on how dirty your oven is.

3 Touch the **START** pad.

The door locks automatically. The display will show the clean time remaining. It will not be possible to open the oven door until the temperature drops below the lock temperature and the **LOCKED DOOR** light goes off.

The oven shuts off automatically when the clean cycle is complete.

4 When the **LOCKED DOOR** light is off, the door will unlock automatically.

■ The words **LOCK DOOR** will flash and the oven control will signal if you set the clean cycle and forget to close the oven door.

■ To stop a clean cycle, touch the **CLEAR/OFF** pad. When the **LOCKED DOOR** light goes off indicating the oven has cooled below the locking temperature, you may open the door.

■ Do not use the lower oven drawer during a self-clean cycle.

## Using the self-cleaning upper oven.

The oven door must be closed and all controls set correctly for the cycle to work properly.

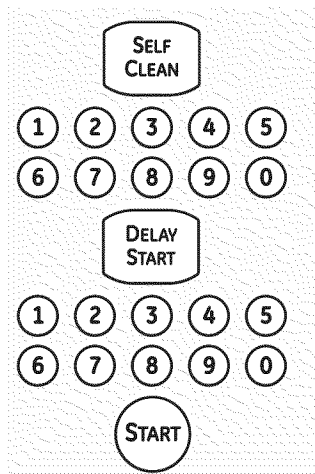

### How to Delay the Start of Cleaning

Make sure the clock shows the correct time of day.

**NOTE:** The surface burners must be turned off prior to the self-clean start time.

**1** Touch the **SELF CLEAN** pad.

**NOTE:** If the display shows **LOC**, touch and hold the **GAS/CONTROL LOCKOUT** pad for 3 seconds to turn it off. See the *Gas/Control Lockout* section.

**2** Using the number pads, enter the desired clean time.

**3** Touch the **DELAY START** pad. The earliest start time you can set will appear in the display.

**4** Using the number pads, enter the time of day you want the clean cycle to start.

**5** Touch the **START** pad.

The door locks automatically. The display will show the start time. It will not be possible to open the oven door until the temperature drops below the lock temperature and the **LOCKED DOOR** light goes off.

The oven shuts off automatically when the clean cycle is complete.

**6** When the **LOCKED DOOR** light is off, the door will unlock automatically.

■ The words **LOCK DOOR** will flash and the oven control will signal if you set the clean cycle and forget to close the oven door.

■ To stop a clean cycle, touch the **CLEAR/OFF** pad. When the **LOCKED DOOR** light goes off indicating the oven has cooled below the locking temperature, you may open the door.

### After a Clean Cycle

You may notice some white ash in the oven. Wipe it up with a damp cloth after the oven cools.

*If white spots remain, remove them with a soap-filled scouring pad and rinse thoroughly with a vinegar and water mixture.*

These deposits are usually a salt residue that cannot be removed by the clean cycle.

If the oven is not clean after one clean cycle, repeat the cycle.

■ You cannot set the oven for cooking until the oven is cool enough for the door to unlock.

■ While the oven is self-cleaning, you can touch the **CLOCK** pad to display the time of day. To return to the clean countdown, touch the **COOKING TIME** pad.

■ If the shelves become hard to slide, apply a small amount of vegetable oil or cooking oil to a paper towel and wipe the edges of the oven shelves with the paper towel.

# Care and cleaning of the range.

Be sure electrical power is off and all surfaces are cool before cleaning any part of the range.

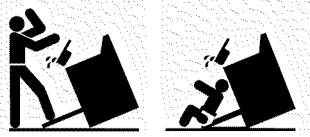

If your range is removed for cleaning, servicing or any reason, be sure the anti-tip device is re-engaged properly when the range is replaced. Failure to take this precaution could result in tipping of the range and cause injury.

## Sealed Burner Assemblies

Turn all controls **OFF** before removing the burner parts.

The round side burner caps and burner heads can be lifted off, making them easy to clean. The electrodes are not removable.

The oval center burner head and cap assembly can be lifted off, making it easy to clean. The burner electrode is not removable.

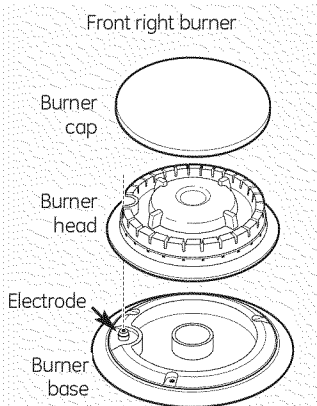

Make sure the hole in the burner head is positioned over the electrode and that the burner head is fully inserted inside the burner base. A small gap between the base and head is normal.

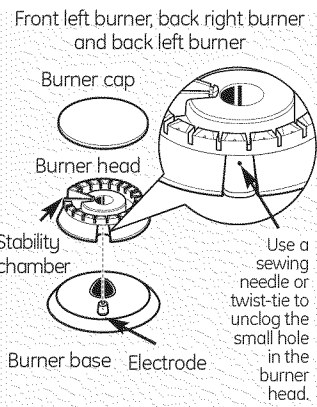

Make sure the slot in the burner head is positioned over the electrode.

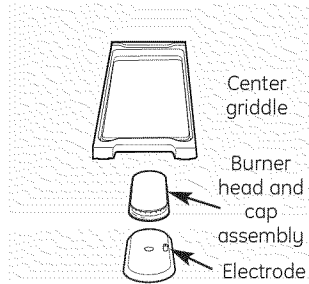

**CAUTION:** Do not operate the cooktop without all burner parts and grates in place.

The electrode of the spark igniter is exposed when the burner head is removed. When one burner is turned to **LITE**, all the burners spark. Do not attempt to disassemble or clean around any burner while another burner is on. An electric shock may result, which could cause you to knock over hot cookware.

# Care and cleaning of the range.

## Burner Caps and Heads

Before removing the burner caps and heads remember their size and location. Replace them in the same location after cleaning.

**NOTE:** Do not use steel wool or scouring powders to clean the burner parts.

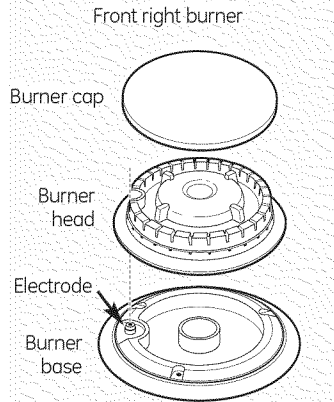
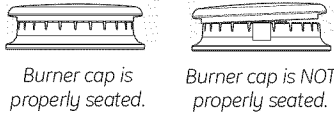

Make sure the hole in the burner head is positioned over the electrode and that the burner head is fully inserted inside the burner base. A small gap between the base and head is normal.

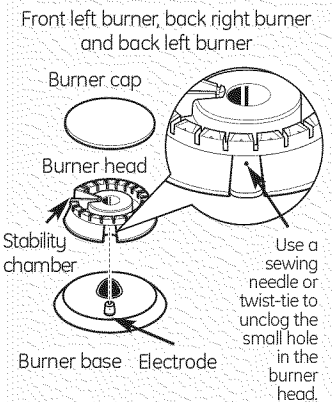

Make sure the slot in the burner head is positioned over the electrode.

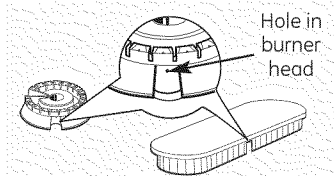

The oval burner head/cap assembly is removable. Simply lift it off the range for cleaning. Use a sewing needle or twist-tie to unplug the small hole in the burner heads.

### Burner caps

Lift off when cool. Wash burner caps in hot, soapy water and rinse with clean water. You may scour with a plastic scouring pad to remove burned-on food particles.

### Burner Heads and Oval (Center) Burner Head/Cap Assembly

The burner heads and the oval burner head/cap assembly are removable. Simply lift them off the range for cleaning.

For proper ignition, make sure the small hole in the section that fits over the electrode is kept open. A sewing needle or wire twist-tie works well to unplug it.

The slits in the burner heads must be kept clean at all times for an even, unhampered flame.

Clogged or dirty burner ports or electrodes will not allow the burner to operate properly.

Any spill on or around an electrode must be carefully cleaned. Take care to not hit an electrode with anything hard or it could be damaged.

Clean the burner heads routinely, especially after bad spillovers, which could clog the openings. Lift off when cool.

To remove burned-on food, soak the burner heads in a solution of mild liquid detergent and hot water for 20–30 minutes. For more stubborn stains, use a toothbrush.

### After cleaning

Before putting the burner caps, heads and oval head/cap assembly back, shake out excess water and then dry them thoroughly by setting in a warm oven for 30 minutes.

## Replacement

### Burner Heads

Replace burner heads over the electrodes on the cooktop, in the correct locations according to their size. There is one small, one medium, one extra large and one dual flame extra large burner head.

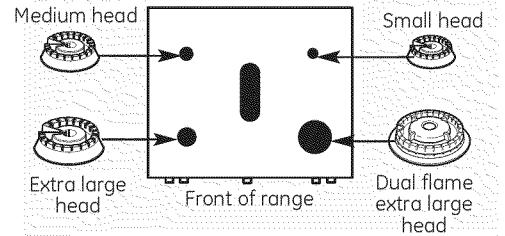

Make sure the slot (on front left, back right and back left heads) and the hole (front right head) in the burner head is positioned over the electrode.

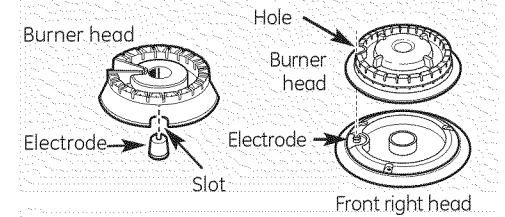

### Oval (Center) Burner Head/Cap Assembly

Replace the oval (center) head/cap assembly over the electrode on the cooktop.

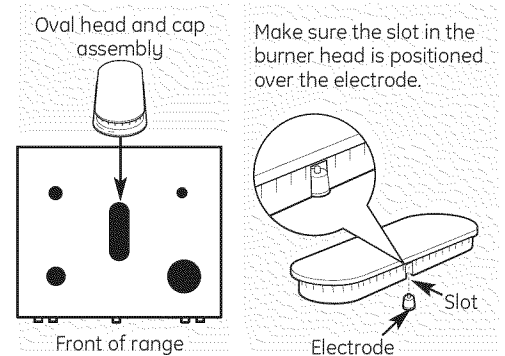

### Caps

Replace the matching size caps onto the burner bases or heads.

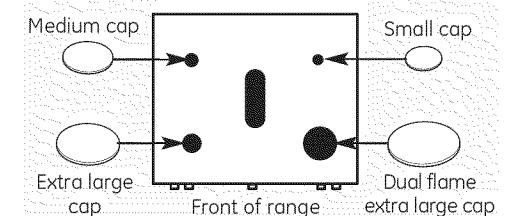

Make sure that the heads and caps are replaced in the correct locations.



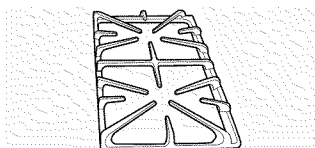

Appearance may vary.

The grates may be cleaned in a dishwasher.

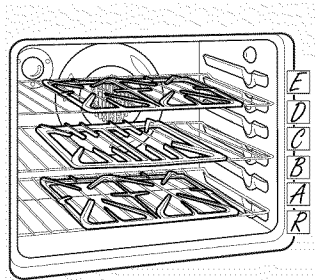
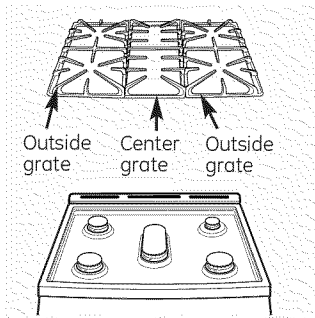

The oven has 5 shelf positions. Place the gray porcelain-coated racks in positions "R", "B" and "D" for self-cleaning the grates. Place one grate each on the oven racks from side to side.

## Burner Grates

Your range has three professional-style double grates. These grates are position-specific. For maximum stability, these grates should only be used in their proper positions. For convenience, the undersides of the side grates are marked "OUTSIDE." Make sure the front portion of both grates is in front. The center grate can be interchanged front to back.

### Cleaning Grates—Soap and Water

Lift grates out when cool. Grates should be washed regularly and, of course, after spillovers. Wash them in hot, soapy water and rinse with clean water. When replacing the grates, be sure they are positioned securely over the burners. Replace the grates so that straight lines are formed with the center ribs of all three grates.

### Cleaning Grates—Self-Clean Oven

To get rid of burned-on food, you may use the self-clean cycle of your range. Remove any burnt-on food particles that you can prior to placing the grates in the oven. Place the gray porcelain-coated racks in positions "R", "B" and "D".

**NOTE:** Do not clean the griddle in the self-cleaning oven.

Place one grate each on the oven racks from side to side. Follow the instructions for how to set the upper oven for cleaning.

**NOTE:** Use caution when removing the grates from the oven after the self-clean cycle has ended. The grates may still be hot.

For heavily-soiled grates, you may notice some white ash on the grate. Wipe it off with a damp cloth after the grate cools.

If white spots remain, remove them with a soap-filled scouring pad and rinse thoroughly with a vinegar and water mixture. These deposits are usually a salt residue that cannot be removed by the clean cycle.

### Cleaning Grates—Dishwasher

The grates may be cleaned in the dishwasher. Remove any burnt-on food particles that you can prior to placing the grates in the dishwasher. Place them on the lowest rack of the dishwasher and run on a "heavy duty" cycle.

Do not operate a burner for an extended period of time without cookware on the grate. The finish on the grate may chip without cookware to absorb the heat.

Although the grates are durable, they will gradually lose their shine, regardless of the best care you can give them. This is due to their continual exposure to high temperatures and abrasion by the cookware.

### Support Bumpers

If one or more of the circular silicone grate support bumpers in the cooktop are missing or damaged, replacement parts can be obtained by calling 1.800.GE.CARES.

To insert the new bumpers, simply insert the cone shaped end and push down while gently twisting or rocking the bumper.

## Cooktop Surface

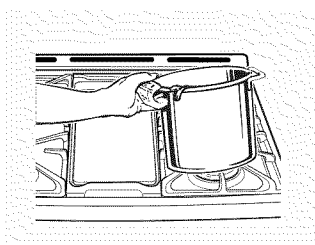

To avoid damaging the stainless steel surface of the cooktop and to prevent it from becoming dull, clean up spills right away. Foods with a lot of acid (tomatoes, sauerkraut, fruit juices, etc.) or foods with high sugar content could cause a dull spot if allowed to set.

When the surface has cooled, wash and rinse. For other spills such as fat splatterings, etc., wash with soap and water once the surface has cooled. Then rinse and polish with a dry cloth.

**NOTE:** Do not store flammable materials in an oven, drawer or near the cooktop. Do not store or use combustible materials, gasoline or other flammable vapors and liquids in the vicinity of this or any other appliance.

**NOTE:** Do not lift the cooktop. Lifting the cooktop can lead to damage and improper operation of the range.

## Care and cleaning of the range.

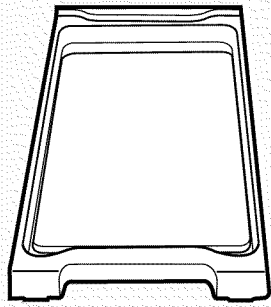

### Griddle

#### NOTES:

- The griddle is to be used over the center burner only.
- Do not clean the griddle in a self-cleaning oven.
- Do not clean the griddle in a dishwasher.
- Wash with hot, soapy water after each use while using a sponge or dishcloth.
- If oil or food residue is left on the griddle, further cooking will harden the residue and cause sticking over time. In this case, use a non-abrasive cleanser such as Bon Ami® or one of the soft scrub cleansers. Apply with a sponge, Scrunge® or other cleaning pad labeled safe for non-stick pans
- Use only plastic, nylon or wooden utensils or SilverStone® kitchen tools to prevent marring of the coating.

- Never use knives or cut food on the griddle. Wash with hot, soapy water after each use. Store carefully to prevent scratching.

#### Griddle Precautions:

- If something has spilled under the griddle, it should be cleaned up as soon as possible to prevent "baked on" food soil.
- Do not allow grease to accumulate under the griddle as it can be a fire hazard. Clean under the griddle as soon as it is cool. Clean with hot soapy water.
- Do not place your griddle in the microwave.
- Always turn off all surface burners before removing the griddle. Use caution when handling a hot griddle.

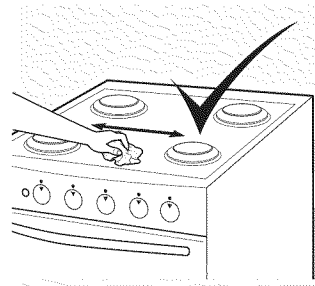

### Stainless Steel Surfaces (on some models)

#### Protecting

STAINLESS STEEL has a reputation for withstanding tough abuse for years. This is a key reason why it is so popular with the food service industry.

However, stainless steel appliances can have surface imperfections, discolorations or blemishes that consumers with a critical eye notice and find unattractive in the home. These discolorations or blemishes can be caused by something as simple as leaving fingerprint smudges on the stainless steel surface overnight.

For stainless steel appliances where blemishes are prone to show on the surface, we recommend APPLYING A COAT OF CERAMA BRYTE® Stainless Steel Cleaning Polish & Conditioner (purchased separately—follow instructions).

This will help you to maintain the brightness and appearance of your stainless steel appliance.

#### Cleaning

**Do not use a steel wool pad; it will scratch the surface.**

- In order to avoid any discolorations and/or grease stains, we recommend cleaning and removing any spills, spots and grease from the range after use.
- It is important to use a soft cloth or paper towel every time the range is cleaned to avoid any scratches.

Read carefully the instructions on the back of the Brightener (included with your range) for better results.

#### Cleaning Instructions:

- 1 Remove grates.
- 2 Wash using warm, soapy water:  
Wet soft cloth or paper towel (avoid using excessive water).  
Wipe the surface in the direction of the grain (following the steel lines).  
Rinse and wring out a soft cloth or paper towel and dry the range.
- 3 Apply a degreaser that does not contain sodium hydroxide or Stainless Steel Cleaner (follow instructions).
- 4 Apply Cerama Bryte® Stainless Steel Brightener (follow instructions).
- 5 Repeat steps 2–4 as many times as needed.
- 6 Put grates back in place.

Follow these instructions for any Stainless Steel surface on your range.

**DO NOT USE the following products for cleaning the Cooktop or Stainless Steel parts:**

- Caustic Lye (Sodium Hydroxide) or cleaners containing this chemical
- Hard or Steel Wool Pads
- Abrasive Materials or Chemicals

To inquire about purchasing stainless steel appliance cleaner or polish, or to find the location of a dealer nearest you, please call our toll-free number:

**National Parts Center 800.626.2002 (U.S.)  
888.261.3055 (Canada)**

**ge.com (U.S.)**

**www.GEAppliances.ca (Canada)**

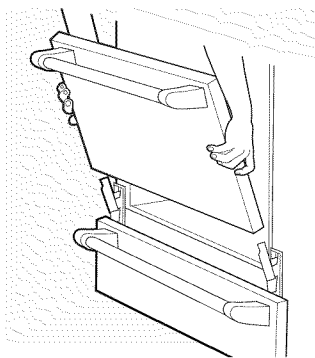

Lift the door straight up and off the hinges.

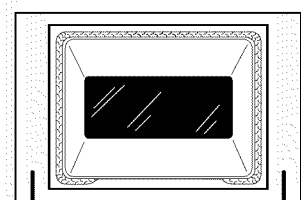

The gasket is designed with a gap at the bottom to allow for proper air circulation.

Do not rub or clean the door gasket—it has an extremely low resistance to abrasion.

If you notice the gasket becoming worn, frayed or damaged in any way or if it has become displaced on the door, you should have it replaced.

## Lift-Off Oven Door

The oven door is removable, but it is heavy. You may need help removing and replacing the door.

Do not lift the door by the handle. Make sure the oven is completely cool.

**To remove the door**, open it a few inches to the special stop position that will hold the door open. Grasp firmly on each side and lift the door straight up and off the hinges.

**NOTE:** Be careful not to place hands between the hinge and the oven door frame as the hinge could snap back and pinch fingers.

**To replace the door**, make sure the hinges are in the special stop position. Position the slots in the bottom of the door squarely over the hinges. Then lower the door slowly and evenly over both hinges at the same time. If the hinges snap back against the oven frame, pull them back out.

### To clean the inside of the door:

- Do not allow excess water to run into any holes or slots in the door.
- Because the area inside the gasket is cleaned during the self-clean cycle, you do not need to clean this by hand. Any soap left on the liner causes additional stains when the oven is heated.

- The area outside the gasket can be cleaned with a soap-filled plastic scouring pad.

Do not allow food spills with a high sugar or acid content (such as milk, tomatoes, sauerkraut, fruit juices or pie filling) to remain on the surface. They may cause a dull spot even after cleaning.

### To clean the outside of the door:

- Use soap and water to thoroughly clean the top, sides and front of the oven door. Rinse well. You may also use a glass cleaner to clean the glass on the outside of the door.
- Spillage of marinades, fruit juices, tomato sauces and basting materials containing acids may cause discoloration and should be wiped up immediately. When the surface is cool, clean and rinse.
- Do not use oven cleaners, cleansing powders or harsh abrasives on the outside of the door.

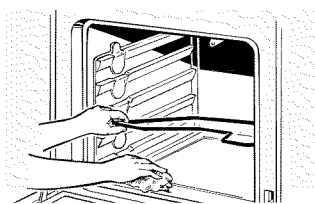

## Oven Heating Elements

Do not clean the bake element or the broil element. Any soil will burn off when the elements are heated.

To clean the oven floor, gently lift the bake element. Clean with warm soapy water.

## Care and cleaning of the range.

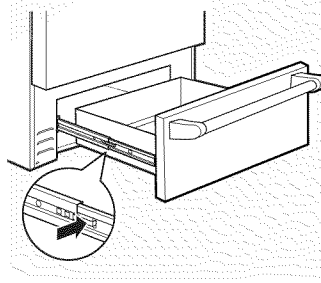

### Removable Lower Oven Drawer

**NOTE:** Before performing any adjustments, cleaning or service, disconnect the range electrical power supply at the household distribution panel by removing the fuse or switching off the circuit breaker. Make sure the drawer heating element is cool.

Most cleaning can be done with the drawer in place. However, the drawer may be removed if further cleaning is needed. Use soap and warm water to thoroughly clean.

#### To remove the drawer:

- 1 Pull the drawer straight out until it stops.
- 2 Press the tabs on both sides in, while pulling the drawer forward and free.

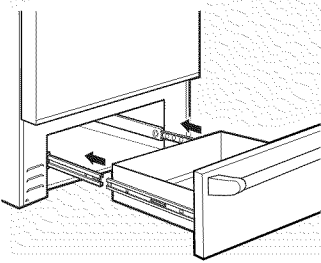

#### To replace the drawer:

- 1 Place the left drawer rail around the inner left rail guide and slide it in slightly to hook it.
- 2 Place the right drawer rail around the inner right rail guide and slide it in slightly to hook it.
- 3 Slide the drawer all the way in.

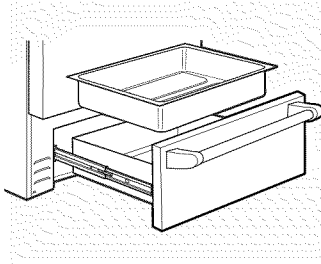

### Removable Lower Oven Drawer Pan

**NOTE:** Before performing any adjustments, cleaning or service, disconnect the range electrical power supply at the household distribution panel by removing the fuse or switching off the circuit breaker. Make sure the drawer heating element is cool.

**NOTE:** Allow lower oven drawer to cool before removing pan.

**NOTE:** Wipe spills promptly after each use.

- Never place, use or self-clean the lower oven drawer pan in the upper oven.
- Lower oven drawer has a removable pan for easy cleaning. Clean with hot, soapy water and a sponge or dish towel. Dry with a clean cloth. An oven cleaner, such as Easy-Off®, may also be used. Be sure to follow the directions on the oven cleaner. Replace the pan in the lower oven drawer.

### Glass Window

To clean the outside glass finish, use a glass cleaner. Rinse and polish with a dry cloth.

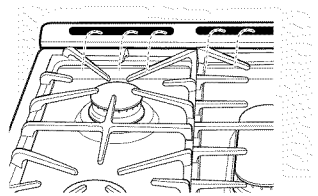

Vent appearance and location vary.

### Oven Air Vents

Never block the vents (air openings) of the range. They provide the air inlet and outlet that are necessary for the range to operate properly with correct combustion.

Air openings are located at the rear of the cooktop, at the top and bottom of the oven door, and at the bottom of the range, under the lower oven drawer.

### Upper Control Panel

Lock out the touch pads before cleaning.

See the *Gas/Control Lockout* information in the *Special features of your oven control* section in this manual.

Clean up splatters with a damp cloth.

You may also use a glass cleaner.

Remove heavier soil with warm soapy water. Do not use abrasives of any kind.

Unlock the touch pads after cleaning.

See the *Control Lockout* information in the *Special features of your oven control* section in this manual.

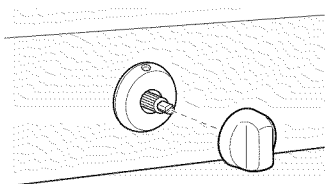

Surface burner knob

### Lower Control Panel and Knobs

It's a good idea to wipe the control panel after each use of the oven. Clean with mild soap and water or vinegar and water, rinse with clean water and polish dry with a soft cloth.

Do not use abrasive cleansers, strong liquid cleaners, plastic scouring pads or oven cleaners on the control panel—they will damage the finish. A 50/50 solution of vinegar and hot water works well.

*The control knobs may be removed for easier cleaning.*

Make sure the knobs are in the **OFF** positions and pull them straight off the stems for cleaning.

The knobs can be cleaned in a dishwasher or they may also be washed with soap and water. Make sure the insides of the knobs are dry before replacing.

Replace the knobs in the **OFF** position to ensure proper placement.

Metal parts can be cleaned with soap and water. Do not use steel wool, abrasives, ammonia, acids or commercial oven cleaners. Dry with a soft cloth.

**NOTE:** *The lower oven drawer control knob is not interchangeable with the surface burner knobs. Be sure to reinstall the lower oven drawer knob to the original location. The lower oven drawer knob may be identified by the increasing numbers from "W<sub>M</sub>" to "450."*

## Care and cleaning of the range.

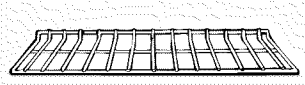

### Oven Shelves and Drawer Racks

Clean the shelves with an abrasive cleanser.

The oven shelves may be cleaned in the self-cleaning oven. However, the shelves will darken in color, lose their luster and become hard to slide if cleaned during the self-cleaning cycle.

To make the shelves slide more easily, apply a small amount of vegetable oil or cooking oil to a paper towel and wipe the edges of the oven shelves with the paper towel.

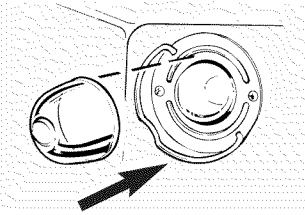

Wire cover holder.

### Oven Light Replacement

**⚠ CAUTION:** Before replacing your oven light bulb, disconnect the electrical power to the range at the main fuse or circuit breaker panel. Be sure to let the light cover and bulb cool completely.

The oven light bulb is covered with a removable glass cover that is held in place with a bail-shaped wire. Remove the oven door, if desired, to reach cover easily.

#### To remove:

- 1 Hold a hand under the cover so it doesn't fall when released. With fingers of the same hand, firmly push back the wire cover holder. Lift off the cover.

**Do not remove any screws to remove the cover.**

- 2 Do not touch hot bulb with a wet cloth. Replace bulb with a 40-watt household appliance bulb.

#### To replace cover:

- 1 Place it into the groove of the light receptacle. Pull the wire forward to the center of the cover until it snaps into place. When in place, the wire holds the cover firmly. Be certain the wire is in the depression in the center of the cover.
- 2 Connect electrical power to the range.

# Installation of the range.

Read these instructions completely and carefully.

## IN THE COMMONWEALTH OF MASSACHUSETTS

- This product must be installed by a licensed plumber or gas fitter.
- When using ball type gas shut-off valves, they shall be the T-handle type.
- A flexible gas connector, when used, must not exceed 3 feet.



### BEFORE YOU BEGIN

Installation of this range must conform with local codes, or in the absence of local codes, with the National Fuel Gas Code, ANSI Z223.1/NFPA.54, latest edition. In Canada, installation must conform with the current Natural Gas Installation Code, AN/CGA-B149.1 or the current Propane Installation Code, CAN/CGA-B149.2, and with local codes where applicable. This range has been design-certified by CSA International according to ANSI Z21.1, latest edition and Canadian Gas Association according to CAN/CGA-1.1 latest edition.

As with any appliance using gas and generating heat, there are certain safety precautions you should follow. You will find these precautions in the *Important Safety Information* section in the front of this manual. Read them carefully.

**IMPORTANT: OBSERVE ALL GOVERNING CODES AND ORDINANCES.**

**NOTE:** This appliance must be properly grounded.

**IMPORTANT:** Save these instructions for the local electrical inspector's use.

**NOTE TO INSTALLER:** Leave these instructions with the appliance after installation is completed.

**NOTE TO CONSUMER:** Keep this Owner's Manual and Installation Instructions for future use.

**SERVICER:** The electrical diagram is in an envelope attached to the back of the range.

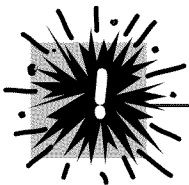

### FOR YOUR SAFETY

Do not store or use combustible materials, gasoline or other flammable vapors and liquids in the vicinity of this or any other appliance.

**If you smell gas:**

- 1 Open windows.
- 2 Don't touch electrical switches.
- 3 Extinguish any open flame.
- 4 Immediately call your gas supplier.



### ELECTRICAL REQUIREMENTS

**⚠ CAUTION:** FOR PERSONAL SAFETY, DO NOT USE AN EXTENSION CORD WITH THIS APPLIANCE. REMOVE HOUSE FUSE OR OPEN CIRCUIT BREAKER BEFORE BEGINNING INSTALLATION.

This appliance must be supplied with the proper voltage and frequency, and connected to an individual, properly grounded circuit, protected by a circuit breaker or time-delay fuse, as noted on the rating plate.

Wiring must conform to National Electric Codes.

If the electric service provided does not meet the above specifications, have a licensed electrician install an approved outlet.

Because range terminals are not accessible after range is in position, flexible service conduit or cord must be used.

## Installation of the range.



### WARNING! INSTALLATION SAFETY INSTRUCTIONS

*Improper installation, adjustment, alteration, service or maintenance can cause injury or property damage. Refer to this manual. For assistance or additional information, consult a qualified installer, service agency, manufacturer (dealer) or the gas supplier.*

Never reuse old flexible connectors. The use of old flexible connectors can cause gas leaks and personal injury. Always use **NEW** flexible connectors when installing a gas appliance.

**IMPORTANT:** Remove all packing material and literature from oven before connecting gas and electrical supply to range.

- Have your range installed by a qualified installer.
- Your range must be electrically grounded in accordance with local codes or, in the absence of local codes, in accordance with the National Electrical Code (ANSI/NFPA 70, latest edition). In Canada, electrical grounding must be in accordance with the current CSA C22.1 Canadian Electrical Code Part I and/or local codes. See Electrical Connections in this section.
- Before installing your range on linoleum or any other synthetic floor covering, make sure the floor covering can withstand 180°F without shrinking, warping or discoloring. Do not install the range over carpeting unless a sheet of 1/4" thick plywood or similar insulator is placed between the range and carpeting.
- Make sure the wall coverings around the range can withstand heat generated by the range up to 200°F.
- Avoid placing cabinets above the range. To reduce the hazard caused by reaching over the open flames of operating burners, install a ventilation hood over the range that projects forward at least 5" beyond the front of the cabinets.

- The ventilating hood must be constructed of sheet metal not less than 0.0122" thick. Install above the cooktop with a clearance of not less than 1/4" between the hood and the underside of the combustible material or metal cabinet. The hood must be at least as wide as the appliance and centered over the appliance. Clearance between the cooking surface and the ventilation hood surface **MUST NEVER BE LESS THAN 24 INCHES.**

**EXCEPTION:** Installation of a listed microwave oven or cooking appliance over the cooktop shall conform to the installation instructions packed with that appliance.

- If cabinets are placed above the range, allow a minimum clearance of 30" between the cooking surface and the bottom of unprotected cabinets.
- If a 30" clearance between cooking surface and overhead combustible material or metal cabinets cannot be maintained, protect the underside of the cabinets above the cooktop with not less than 1/4" insulating millboard covered with sheet metal not less than 0.0122" thick.
- Clearance between the cooking surface and protected cabinets **MUST NEVER BE LESS THAN 24 INCHES.** The vertical distance from the plane of the cooking surface to the bottom of adjacent overhead cabinets extending closer than 1" to the plane of the range sides must not be less than 18". (See the *Dimensions and Clearances* illustration in this section.)

**CAUTION:** *Items of interest to children should not be stored in cabinets above a range or on the backsplash of a range—children climbing on the range to reach items could be seriously injured.*



Read these instructions completely and carefully.

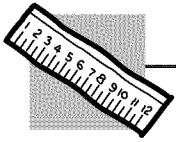

## DIMENSIONS AND CLEARANCES

Provide adequate clearances between the range and adjacent combustible surfaces. These dimensions must be met for safe use of your range. The location of the electrical outlet and pipe opening (see Gas Pipe and Electric Outlet Locations) may be adjusted to meet specific requirements.

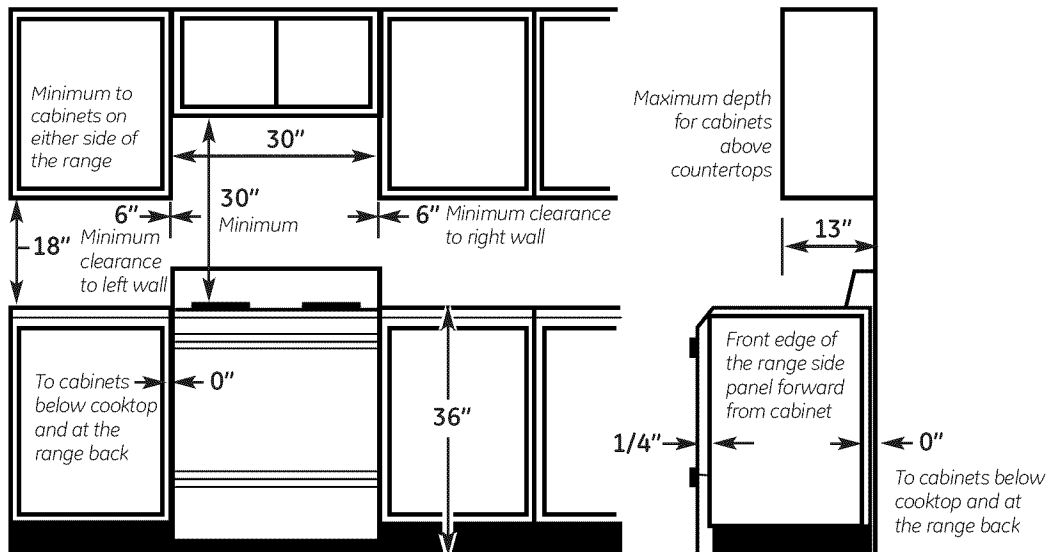
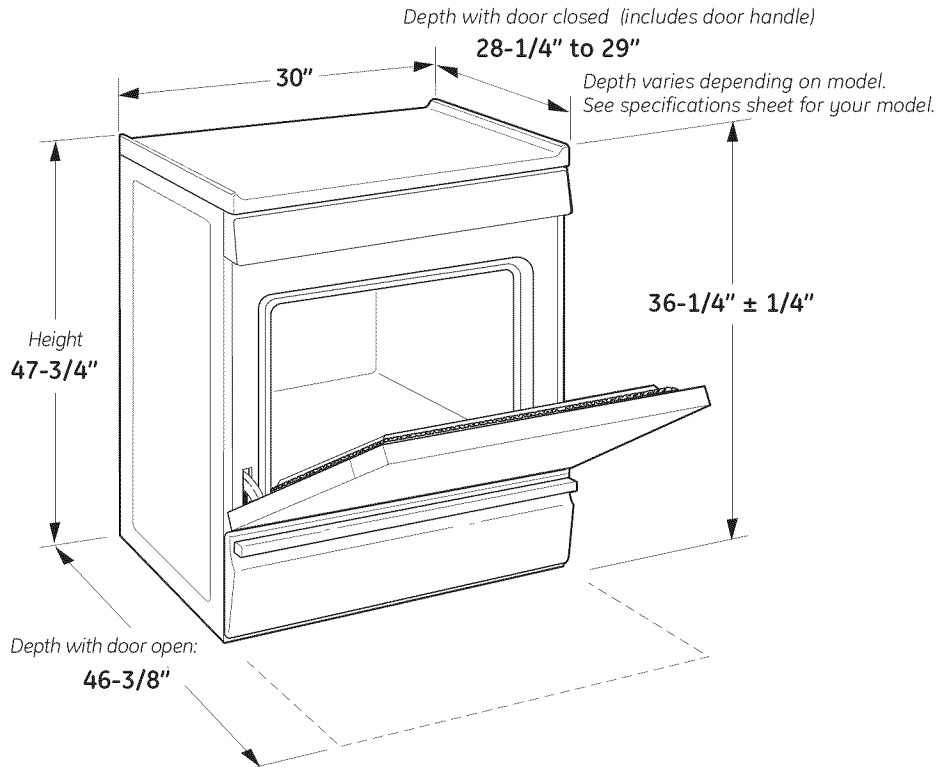

## Installation of the range.

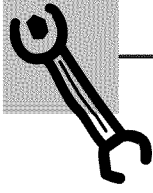

### TOOLS YOU WILL NEED

- Phillips and flat-blade screwdrivers
  - Pencil and ruler
  - Two pipe wrenches (one for backup)
  - Open-end or adjustable wrench
  - Nut driver or wrench: 1/4"
  - Drill
  - Flare union adapter for connection to gas supply line (3/4" or 1/2" NPT x 1/2" I.D.)
  - Flare union adapter for connection to pressure regulator on range (1/2" NPT x 1/2" I.D.)
  - Liquid leak detector or soapy water.
  - Lag bolt or 1/2" O.D. Sleeve anchor (for concrete floors only).
  - Squeeze Connector matching the size of the bracket opening (on the range back behind the wiring cover) and the house conduit. Obtain only if replacing the power cord with conduit.
- ADDITIONAL MATERIALS YOU MAY NEED:**
- Gas line shut-off valve
  - Pipe joint sealant or UL-approved pipe thread tape with Teflon\* that resists action of natural and LP gases.  
\*Teflon: Registered trademark of DuPont
  - Flexible metal appliance connector (1/2" I.D.). A 5-foot length is recommended for ease of installation but other lengths are acceptable. Never use an old connector when installing a new range.



### LOCATION GUIDELINES

Do not locate the range where it may be subject to strong drafts. Any openings in the floor or wall behind the range should be sealed. Make sure the openings around the base of the range that supply fresh air for combustion and ventilation are not obstructed by carpeting or woodwork.

Your range, like many other household items, is heavy and can settle into soft floor coverings such as cushioned vinyl or carpeting. Use care when moving the range on this type of flooring. It is recommended that the following simple and inexpensive instructions be followed to protect your floor.

The range should be installed on a sheet of plywood (or similar material). When the floor covering ends at the front of the range, the area that the range will rest on should be built up with plywood to the same level or higher than the floor covering.

This will allow the range to be moved for cleaning or servicing. Also, make sure your floor covering will withstand 180°F. (See the *Installation Safety Instructions* section.)

Make sure the wall coverings around your range can withstand the heat generated (up to 200°F) by the range. (See the *Installation Safety Instructions* section.)



### IMPORTANT!

Remove all tape and packaging. Make sure the burners are properly seated and level.

Take the accessory pack out of the oven.

Check to be sure that no range parts have come loose during shipping.

Read these instructions completely and carefully.

## 7 Gas Supply Requirements

### Recommended Gas Pipe Outlet Locations

**NOTE:** Make gas connections on the left side of the cutout opening.

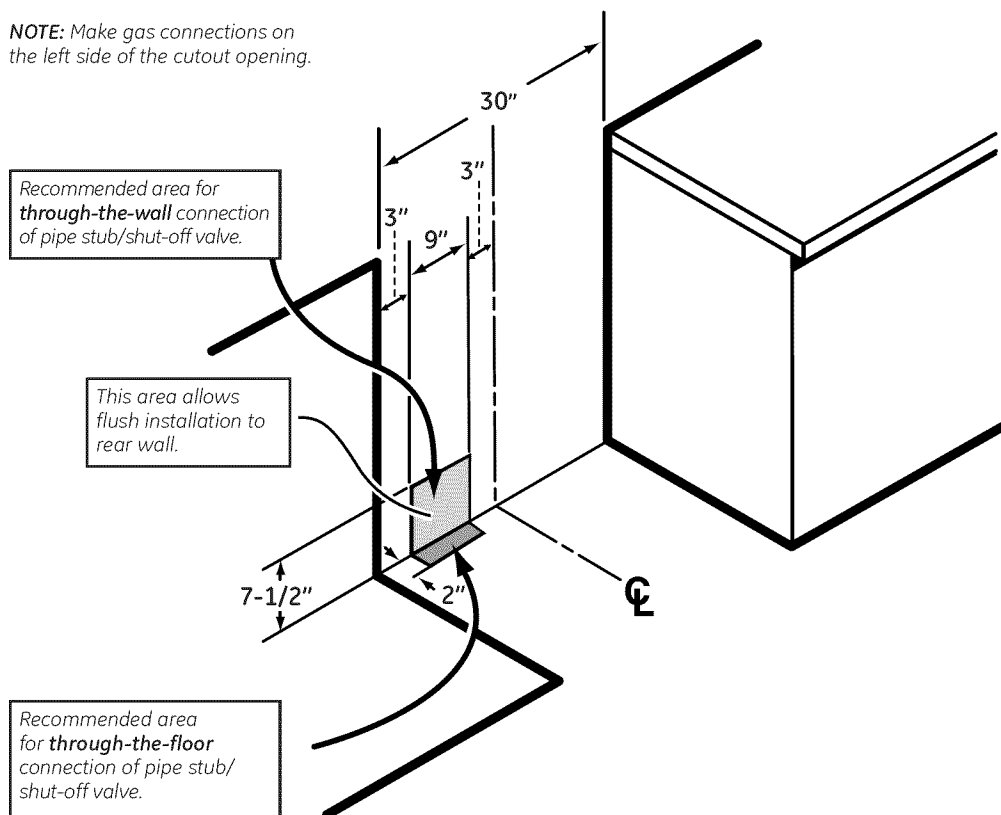

### Provide Adequate Gas Supply

Your range is designed to operate at a pressure of 5" of water column on natural gas or, if designed for LP gas (propane or butane), 10" of water column.

Make sure you are supplying your range with the type of gas for which it is designed.

This range is convertible for use on natural or propane gas. If you decide to use this range on LP gas, conversion must be made by a qualified LP installer before attempting to operate the range on that gas.

For proper operation, the pressure of natural gas supplied to the regulator must be between 5" and 13" of water column.

For LP gas, the pressure supplied must be between 10" and 13" of water column.

When checking for proper operation of the regulator, the inlet pressure must be at least 1" greater than the operating (manifold) pressure as given above.

The pressure regulator located at the inlet of the range manifold must remain in the supply line regardless of whether natural or LP gas is being used.

A flexible metal appliance connector used to connect the range to the gas supply line should have an I.D. of 1/2" and be 5 feet in length for ease of installation. In Canada, flexible connectors must be single wall metal connectors no longer than 6 feet in length.

# Installation of the range.

## 2 Electrical Power Supply Requirements

### Recommended Electrical Outlet Locations

**NOTE:** Make electrical connections on the right side of the cutout opening.

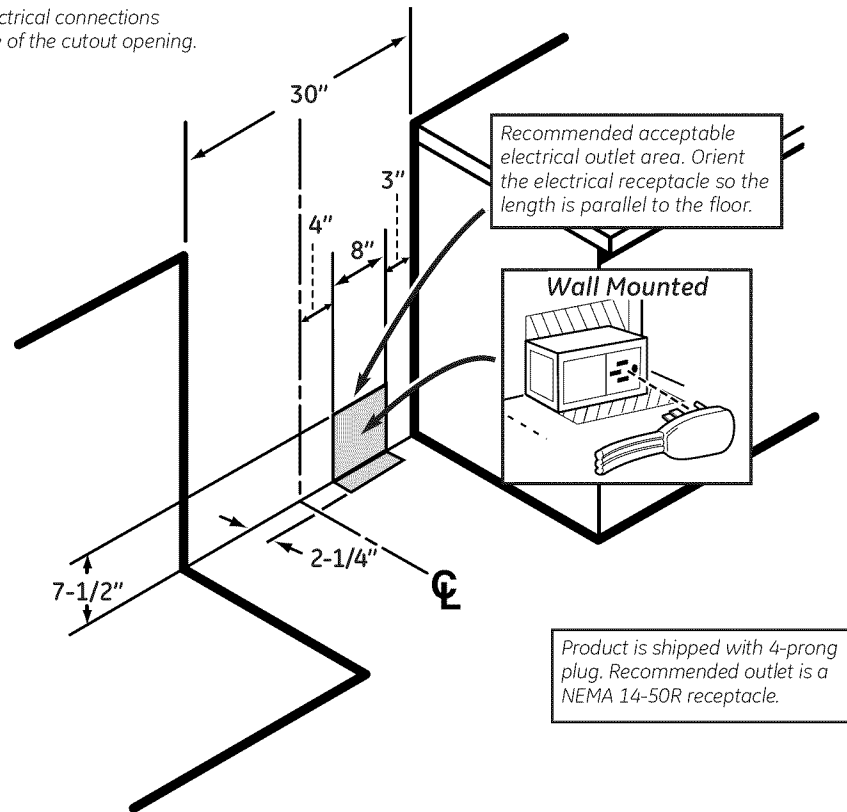

### Provide Proper Electrical Supply

These ranges must be supplied with 208/240 volt, 60 Hz., and connected to an individual, properly grounded circuit protected by a circuit breaker or time-delay fuse (40 amp). The receptacle must be NEMA 14-50R to accept the 4-prong plug supplied with the range.

If the electrical service provided does not meet the above specifications, it is recommended that a licensed electrician install an approved outlet.

■ Locate the electric supply as illustrated.

Read these instructions completely and carefully.

### 3 Connect the Range to the Gas Supply

Shut off the main gas supply valve before disconnecting the old range and leave it off until the new hookup has been completed. Don't forget to relight the pilot on other gas appliances when you turn the gas back on.

Because hard piping restricts movement of the range, the use of a CSA International-certified flexible metal appliance connector is recommended unless local codes require a hard-piped connection.

Never use an old connector when installing a new range. If the hard piping method is used, you must carefully align the pipe; the range cannot be moved after the connection is made.

To prevent gas leaks, put pipe joint compound on, or wrap pipe thread tape with Teflon\* around, all male (external) pipe threads.

**A** Install a manual gas line shut-off valve in the gas line in an easily accessed location outside of the range. Make sure everyone operating the range knows where and how to shut off the gas supply to the range.

**B** Install male 1/2" flare union adapter to the 1/2" NPT internal thread elbow at inlet of regulator. Use a backup wrench on the regulator fitting to avoid damage.

When installing the range from the front, remove the 90° elbow for easier installation.

**C** Install male 1/2" or 3/4" flare union adapter to the NPT internal thread of the manual shut-off

valve, taking care to backup the shut-off valve to keep it from turning.

**D** Connect flexible metal appliance connector to the adapter on the range. Position range to permit connection at the shut-off valve.

**E** When all connections have been made, make sure all range controls are in the off position and turn on the main gas supply valve. Use a liquid leak detector at all joints and connections to check for leaks in the system.

**CAUTION: DO NOT USE A FLAME TO CHECK FOR GAS LEAKS.**

When using test pressures greater than 1/2 psig to pressure test the gas supply system of the residence, disconnect the range and individual shut-off valve from the gas supply piping. When using test pressures of 1/2 psig or less to test the gas supply system, simply isolate the range from the gas supply system by closing the individual shut-off valve.

\*Teflon: Registered trademark of DuPont

#### Flexible Connector Hookup

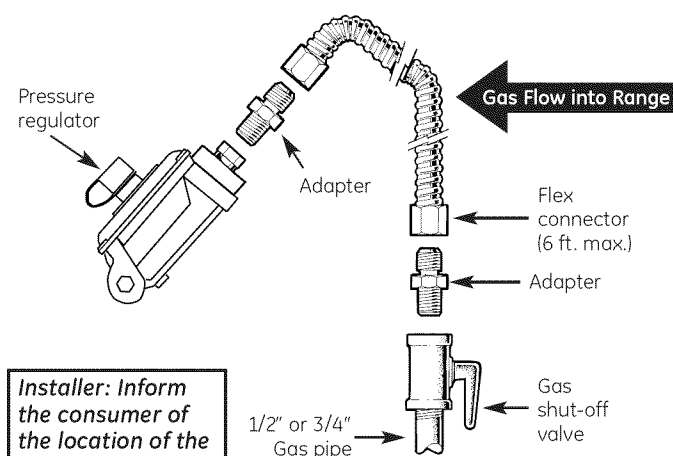

Installer: Inform the consumer of the location of the gas shut-off valve.

#### Rigid Pipe Hookup Options

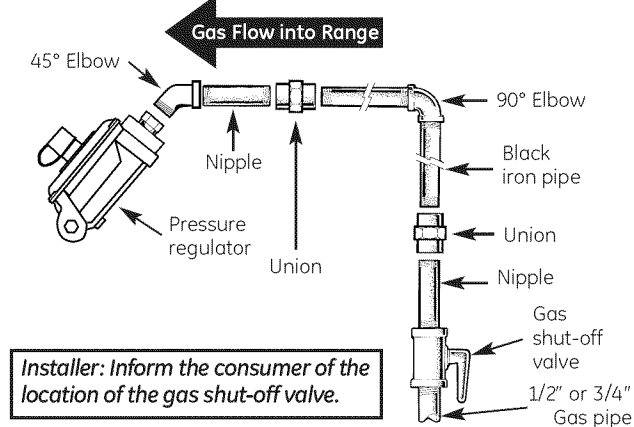

Installer: Inform the consumer of the location of the gas shut-off valve.

#### Alternate Hookup

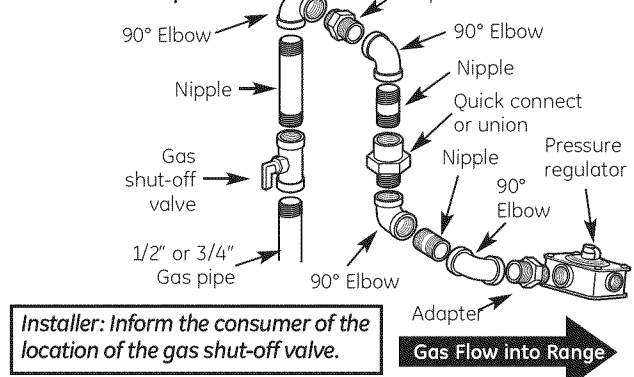

Installer: Inform the consumer of the location of the gas shut-off valve.

## Installation of the range.

### 4 Connect the Range to the Electrical Supply

Skip to Step 5 if the power cord shipped on the range does not match your wall receptacle.

#### Using an Existing NEMA 14-50R Receptacle

- Plug the range power cord into a properly grounded wall receptacle. Skip to Step 6 if the range power cord matches the wall receptacle.

**NOTE:** Your range is shipped with a 4-prong plug to be used in a NEMA 14-50R receptacle. Should you choose to change your plug, use only a 3-wire power cord, 3-wire conduit or 4-wire conduit. Follow the appropriate instructions below, in Step 5, for your application.

Effective January 1, 1996, the National Electric Code requires that new construction (not existing) utilize a 4-conductor connection to an electric range.

A range cord rated at 40 amps with 125/250 minimum volt range is required. A 50-amp range cord is not recommended but if used, it should be marked for use with nominal 1 $\frac{3}{8}$ " diameter connection openings. Care should be taken to center the cable and strain relief within the knockout hole to keep the edge from damaging the cable.

**NOTE:** A 4-conductor cord is to be used when the appliance is installed in a mobile home or when local codes do not permit grounding through the neutral.

### 5 Replace the Power Cord (Optional)

Perform this step only if the power cord shipped on the range does not match your wall receptacle.

- 1 Remove the wire cover (on the back of the range) by removing two (2) screws using a 1/4" nut driver.

**Do not discard these screws.**

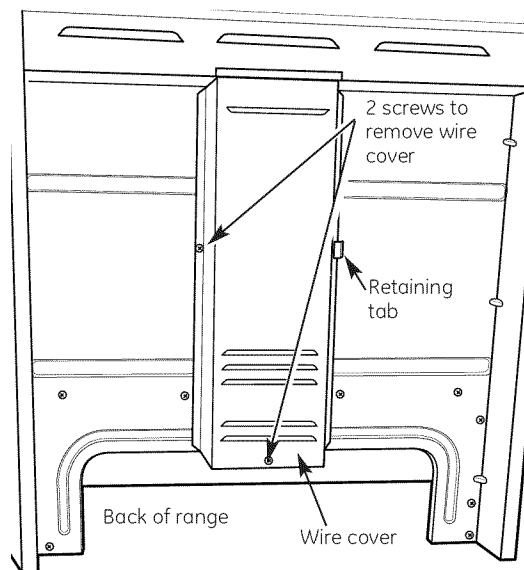

- 2 Remove the 3 lower power cord terminal screws from the terminal block and the ground screw and plate.

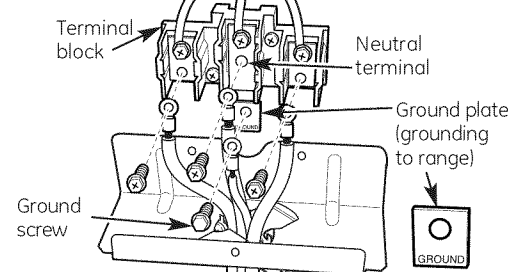

- 3 Place the terminal screws and ground screw in safe location for later use.

- 4 Loosen the strain relief screws and remove the power cord.

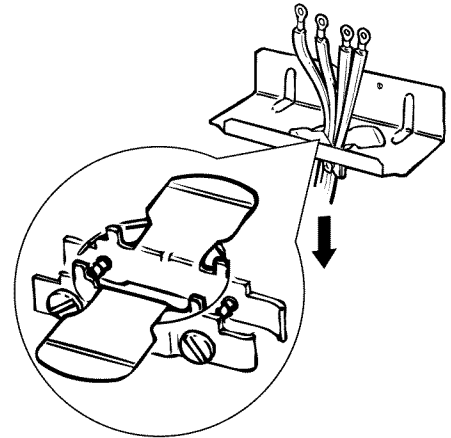

**NOTE:** The replacement power cord must be a 3-conductor or a 4-conductor UL-listed range cord or conduit. Cords may be provided with ring terminals on wire and a strain relief device.

- 5 Follow the 3-wire power cord (option 5A), 3-wire conduit (option 5B) or 4-wire conduit (option 5C) sections as appropriate for your application.

Read these instructions completely and carefully.

### 5 Replace the Power Cord (Optional) Continued

Perform this step only if the power cord shipped on the range does not match your wall receptacle.

#### A 3-Wire Power Cord Installation Option

**⚠ WARNING:** The neutral or ground wire of the power cord must be connected to the neutral terminal located in the center of the terminal block. The power leads must be connected to the lower left and the lower right terminals of the terminal block.

- 1 Locate the copper ground strap on the lower back of the range.
- 2 Loosen the upper center screw on the terminal block.
- 3 Slide the open slotted end of the ground strap under the upper center screw on the terminal block. Make sure the ground strap is all the way against the upper center screw and tighten it in place.
- 4 Place the ground plate (removed earlier) over the bottom of the ground strap, press them against the range frame and attach them with the ground screw (removed earlier).
- 5 Insert the new power cord through the strain relief. Allow enough slack to easily attach the wires to the terminal block.
- 6 Insert the 3 terminal screws (removed earlier) through each power cord terminal ring and into the lower terminals of the terminal block. Be certain that the center wire (white/neutral) is connected to the center lower position of the terminal block. Tighten screws securely (approximately 20 inch-lbs.) into the terminal block.
- 7 Secure the strain relief in place in the bracket by tightening the strain relief screws.

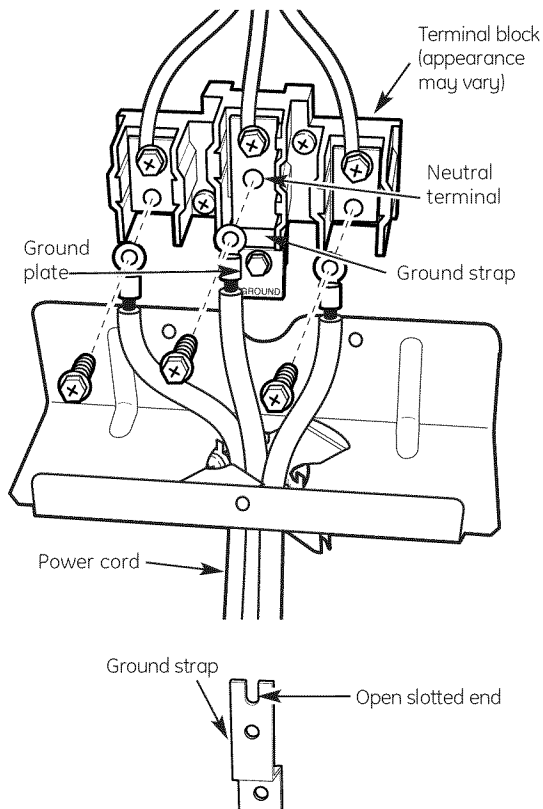

## Installation of the range.

### 5 Replace the Power Cord (Optional) Continued

Perform this step only if the power cord shipped on the range does not match your wall receptacle.

#### B 3-Wire Conduit Installation Option

- 1 Locate the copper ground strap on the lower back of the range.
- 2 Loosen the upper center screw on the terminal block.
- 3 Slide the open slotted end of the ground strap under the upper center screw on the terminal block. Make sure the ground strap is all the way against the upper center screw and tighten it in place.
- 4 Place the ground plate (removed earlier) over the bottom of the ground strap, press them against the range frame and attach them with the ground screw (removed earlier).
- 5 Remove the strain relief clamp from the bracket.
- 6 Assemble the squeeze connector (obtained locally), matching the diameter of your conduit, in the bracket hole. Insert the conduit through the squeeze connector. Allow enough slack to easily attach the wires to the terminal block.

**NOTE:** Do not install the conduit without a squeeze connector.

- 7 Insert the center bare wire (white/neutral) tip through the bottom center terminal block opening. On certain models, the wire will need to be inserted through the ground strap opening and then into the bottom center terminal block opening. Insert the two side bare wire tips into the lower left and the lower right terminal block openings. Tighten the screws until the wire is firmly secure (approximately 20 inch-lbs.).

**NOTE:** Make sure the wire is completely inserted into the terminal block and a secure connection is made.

- 8 Secure the squeeze connector in place in the bracket by tightening the squeeze connector screws.

**NOTE: ALUMINUM WIRING:**

Aluminum building wire may be used but it must be rated for the correct amperage and voltage to make connection.

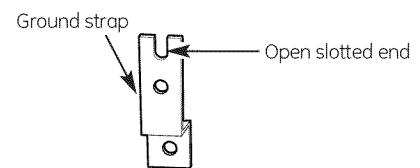
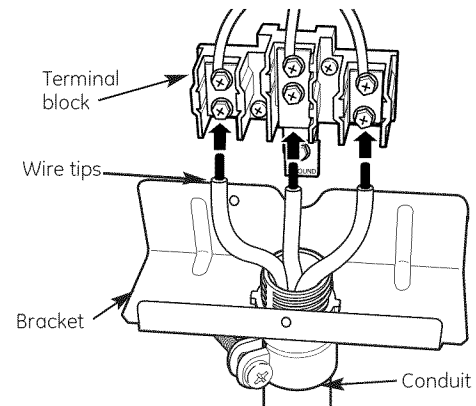
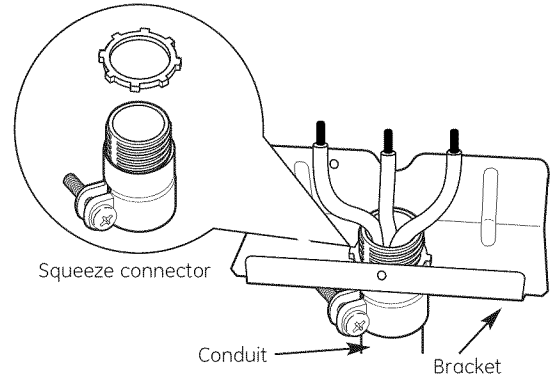

**Wire used, location and enclosure of splices, etc., must conform to good wiring practices and local codes.**



Read these instructions completely and carefully.

### 5 Replace the Power Cord (Optional) Continued

Perform this step only if the power cord shipped on the range does not match your wall receptacle.

#### C 4-Wire Conduit Installation Option

- 1 Remove the strain relief clamp from the bracket.
- 2 Assemble the squeeze connector (obtained locally), matching the diameter of your conduit, in the bracket hole. Insert the conduit through the squeeze connector. Allow enough slack to easily attach the wires to the terminal block.

**NOTE:** Do not install the conduit without a squeeze connector.

- 3 Insert the ground bare wire tip between the range frame and the ground plate (removed earlier) and secure it in place with the ground screw (removed earlier). Insert the bare wire (white/neutral) tip through the bottom center of the terminal block opening. Insert the two side bare wire tips into the lower left and the lower right terminal block openings. Tighten the screws until the wire is firmly secure (approximately 20 inch-lbs.).

**NOTE:** Make sure the wire is completely inserted into the terminal block and a secure connection is made.

- 4 Secure the squeeze connector in place in the bracket by tightening the squeeze connector screws.

#### **NOTE: ALUMINUM WIRING:**

Aluminum building wire may be used but it must be rated for the correct amperage and voltage to make connection.

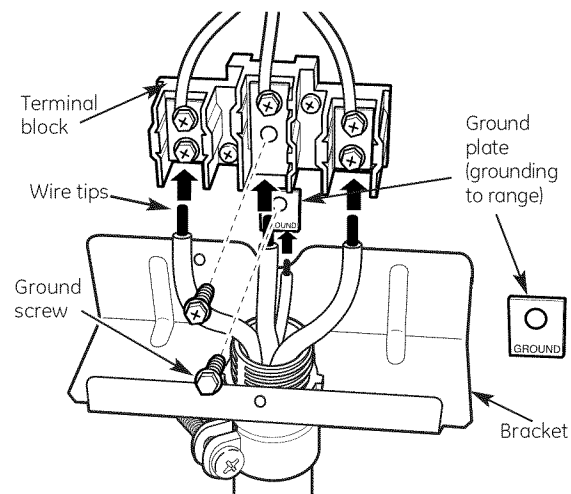
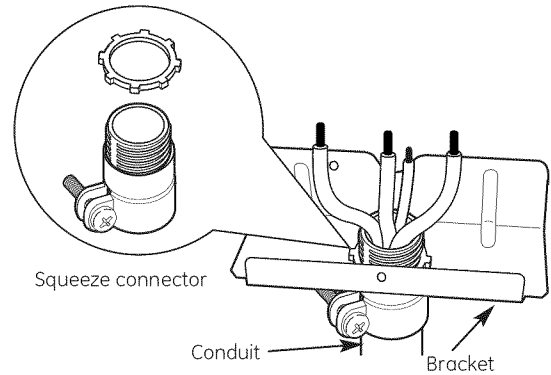

Wire used, location and enclosure of splices, etc., must conform to good wiring practices and local codes.

### D Replace the Wire Cover

Replace the wire cover on the range back by sliding its right edge under the retaining tab and replacing the two screws removed earlier. Make sure that no wires are pinched between the cover and the range back.

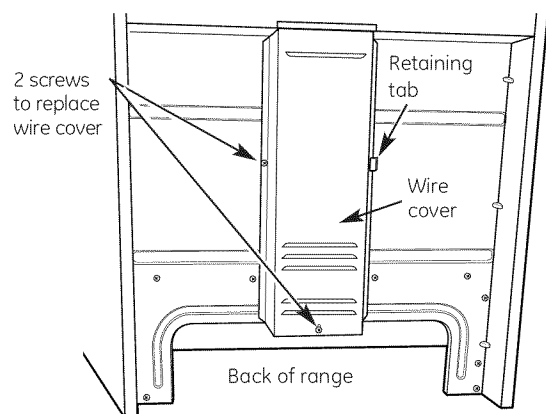

# Installation of the range.

## 6 Seal the Openings

Seal any openings in the wall behind the range and in the floor under the range when hookups are completed.

## 7 Assemble Surface Burners

### A Burner Heads (on some models)

Place burner heads over the electrodes on the cooktop, in the correct locations according to their size. There is one small, one medium, one extra large and one dual flame extra large burner head.

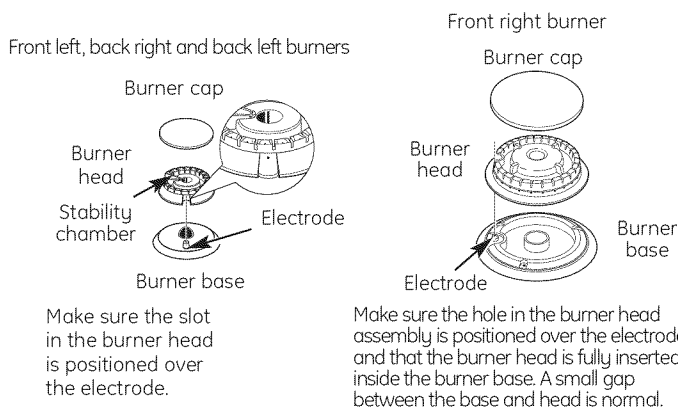
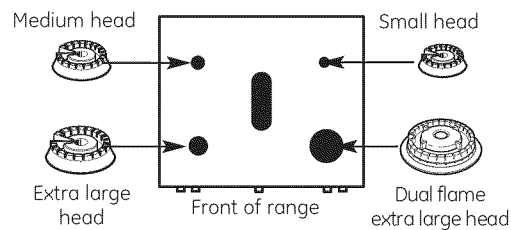

### B Oval (Center) Burner Head/Cap Assembly

Place the oval (center) head/cap assembly over the electrode on the cooktop.

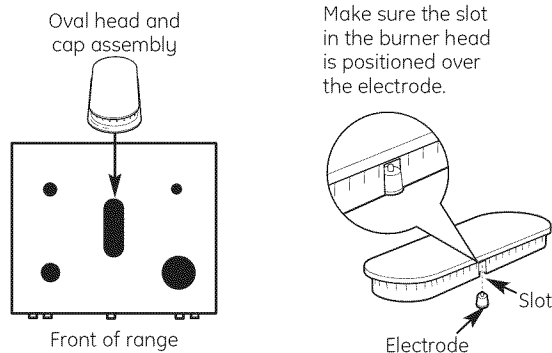

### C Caps

Place the matching size caps onto the burner bases or heads.

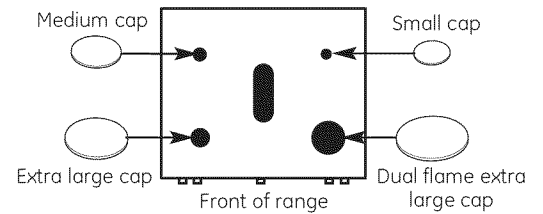

Make sure that the heads and caps are replaced in the correct locations.

### D Grates

Place the left, right and center grates on the cooktop. These grates are position specific. The undersides of the left and right grates are marked "OUTSIDE." Place the middle grate with its bowed front toward the front of the range.

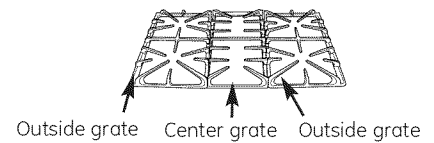

**CAUTION:** Do not operate the burner without all burner parts in place.

Read these instructions completely and carefully.

## 8 Check Ignition of Surface Burners

Operation of all cooktop burners should be checked after the range and gas supply lines have been carefully checked for leaks.

### Electric Ignition

Select a top burner knob and simultaneously push in and turn to **LITE** position. You will hear a **clicking** sound indicating proper operation of the spark module. Once the air has been purged from the supply lines, burners should light within 4 seconds. After burner lights, rotate knob out of the **LITE** position. Try each burner in succession until all burners have been checked.

## Quality of Flames

The combustion quality of burner flames needs to be determined visually.

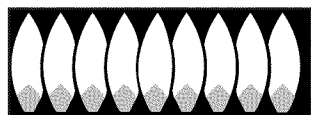

(A) Yellow flames—  
Call for service

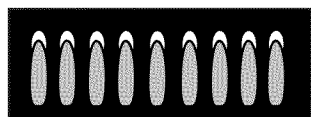

(B) Yellow tips on  
outer cones—  
Normal for LP gas



(C) Soft blue  
flames—Normal  
for natural gas

If burner flames look like (A), call for service. Normal burner flames should look like (B) or (C), depending on the type of gas you use.

With LP gas, some yellow tipping on outer cones is normal.

## 9 Level the Range

- A** Install the oven shelves in the oven and position the range where it will be installed.

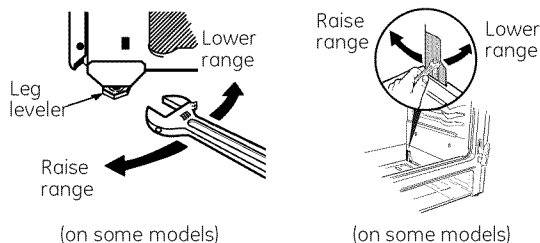

- B** Check for levelness by placing a spirit level or a cup, partially filled with water, on one of the oven shelves. If using a spirit level, take two readings—with the level placed diagonally first in one direction and then the other.

- C** Remove the lower oven drawer. See the *Care and cleaning of the range* section. The front leveling legs can be adjusted from the bottom and the rear legs can be adjusted from the top or the bottom.
- D** Use an open-end or adjustable wrench to adjust the leveling legs until the range is level.

**⚠ WARNING:** Never completely remove the leveling leg as the range will not be secured to the anti-tip device properly.

- E** After the range is level, slide the range away from the wall so that the Anti-Tip device can be installed.

## Installation of the range.

### 10 Anti-Tip Device Installation



**! WARNING**

- All ranges can tip.
- **BURNS** or other **SERIOUS INJURIES** can result.
- **INSTALL** and **CHECK** the **ANTI-TIP** bracket following the instructions supplied with the bracket.

To reduce the risk of tipping the range, the range must be secured by a properly installed anti-tip bracket. See installation instructions shipped with the bracket for complete details before attempting to install.

To check if the bracket is installed and engaged properly, remove the storage drawer or kick panel and look underneath the range to see that the leveling leg is engaged in the bracket. On models without a storage drawer or kick panel, carefully tip the range forward. The bracket should stop the range within 4 inches. If it does not, the bracket must be reinstalled. If the range is pulled from the wall for any reason, always repeat this procedure to verify the range is properly secured by the anti-tip bracket. Never completely remove the leveling legs or the range will not be secured to the anti-tip device properly.

If you did not receive an anti-tip bracket with your purchase, call 1.800.626.8774 to receive one at no cost. (In Canada, call 1.800.561.3344.) For installation instructions of the bracket, visit [www.GEAppliances.com](http://www.GEAppliances.com). (In Canada, [www.GEAppliances.ca](http://www.GEAppliances.ca).)

#### *When All Hookups Are Completed:*

**MAKE SURE ALL CONTROLS ARE LEFT IN THE OFF POSITION.**

**MAKE SURE THE FLOW OF COMBUSTION AND VENTILATION AIR TO THE RANGE IS UNOBSTRUCTED.**

#### *Converting to LP Gas (or converting back to natural gas from LP)*

*This range leaves the factory set for use with natural gas. If you want to convert to LP gas, the conversion must be performed by a qualified LP gas installer.*

The conversion instructions and LP orifices can be found attached to the range next to the pressure regulator.

Keep these instructions and the orifices in case you want to convert back to natural gas.

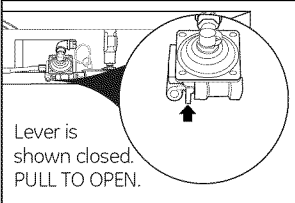
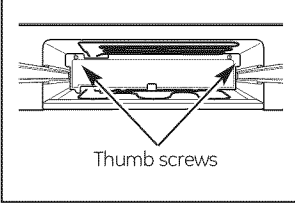

**Troubleshooting Tips**  
Save time and money! Review the charts on the following pages first and you may not need to call for service.

Problem	Possible Causes	What To Do
Top burners do not light or do not burn evenly	Plug on range is not completely inserted in the electrical outlet.	<ul style="list-style-type: none"> <li>Make sure electrical plug is plugged into a live, properly grounded outlet.</li> </ul>
	Burner hole or slits on the side of the burner may be clogged.	<ul style="list-style-type: none"> <li>Remove the burner caps and clean them. Check and clean the electrode area for burned-on food or grease. See the <i>Care and cleaning of the range</i> section.</li> </ul>
	Improper burner assembly.	<ul style="list-style-type: none"> <li>Make sure the burner parts are installed correctly. See the <i>Care and cleaning of the range</i> section.</li> </ul>
Surface burners light but oven does not	The oven gas shut-off valve may have accidentally been moved during cleaning or moving.	<ul style="list-style-type: none"> <li>To check the oven gas shut-off valve, remove the drawer (see the <i>Care and cleaning of the range</i> section) Remove the rear access panel by unscrewing the thumb screws in the upper left and right corner. Look for the gas shut-off lever at the back of the range.</li> </ul>
		<div style="display: flex; justify-content: space-around;"> <div style="text-align: center;">  <p>Lever is shown closed. PULL TO OPEN.</p> </div> <div style="text-align: center;">  <p>Thumb screws</p> </div> </div>
Burner flames very large or yellow	Improper air to gas ratio.	<ul style="list-style-type: none"> <li>If range is connected to LP gas, contact the person who installed your range or made the conversion.</li> </ul>
Control signals after entering cooking time or start time	You forgot to enter a bake temperature or cleaning time.	<ul style="list-style-type: none"> <li>Touch the <b>BAKE</b> pad and desired temperature or the <b>SELF CLEAN</b> pad and desired clean time.</li> </ul>
Food does not bake or roast properly in the upper oven	Oven controls improperly set.	<ul style="list-style-type: none"> <li>See the <i>Using the upper oven</i> section.</li> </ul>
	Shelf position is incorrect.	<ul style="list-style-type: none"> <li>See the <i>Using the upper oven</i> section.</li> </ul>
	Incorrect cookware or cookware of improper size being used.	<ul style="list-style-type: none"> <li>See the <i>Using the upper oven</i> section.</li> </ul>
	Oven thermostat needs adjustment.	<ul style="list-style-type: none"> <li>See the <i>Adjust the upper oven thermostat—Do it yourself!</i> section.</li> </ul>
	Clock not set correctly.	<ul style="list-style-type: none"> <li>See the <i>Using the clock and timer</i> section.</li> </ul>
	Aluminum foil used improperly in the oven.	<ul style="list-style-type: none"> <li>See the <i>Care and cleaning of the range</i> section.</li> </ul>
	Oven bottom not securely seated in position.	<ul style="list-style-type: none"> <li>See the <i>Installation of the range</i> section.</li> </ul>
Burners do not light	Gas/Control Lockout feature is activated.	<ul style="list-style-type: none"> <li>Allow the range to cool down and touch and hold the <b>GAS/CONTROL LOCKOUT</b> pad (on some models) for 3 seconds until <b>LOC</b> disappears from the display.</li> </ul>
	Plug on range is not completely inserted in the electrical outlet.	<ul style="list-style-type: none"> <li>Make sure electrical plug is plugged into a live, properly grounded outlet.</li> </ul>
	Gas supply not connected or turned on.	<ul style="list-style-type: none"> <li>See the Installation Instructions that came with your range.</li> </ul>
	A fuse in your home may be blown or circuit breaker tripped.	<ul style="list-style-type: none"> <li>Replace the fuse or reset the circuit breaker.</li> </ul>
	Burner parts not replaced correctly.	<ul style="list-style-type: none"> <li>See the <i>Care and cleaning of the range</i> section.</li> </ul>

## Before you call for service...



### Troubleshooting Tips

Problem	Possible Causes	What To Do
<i>Gas/Control Lockout or Control Lockout feature is activated</i>		<ul style="list-style-type: none"> <li>If <b>LOC ON</b> appears in the display, the range control is locked. Turn this feature off to use the range. See the <i>Gas/Control Lockout</i> section.</li> </ul>
<i>"Close Door" scrolls in the display when BROIL is set</i>	The display will always automatically remind you to close the door.	<ul style="list-style-type: none"> <li>This is a normal reminder to close the door when broiling.</li> </ul>
<i>Food does not broil properly in the upper oven</i>	Oven controls improperly set.	<ul style="list-style-type: none"> <li>Make sure you touch the <b>BROIL HI/LO</b> pad.</li> </ul>
	Oven door not closed.	<ul style="list-style-type: none"> <li>See the <i>Using the upper oven</i> section.</li> </ul>
	Improper shelf position being used.	<ul style="list-style-type: none"> <li>See the <i>Broiling Guide</i>.</li> </ul>
	Food being cooked in a hot pan.	<ul style="list-style-type: none"> <li>For best results, use a pan designed for broiling. Make sure it is cool.</li> </ul>
	Cookware not suited for broiling.	<ul style="list-style-type: none"> <li>For best results, use a pan designed for broiling.</li> </ul>
	Oven bottom not securely seated in position.	<ul style="list-style-type: none"> <li>See the <i>Installation of the range</i> section.</li> </ul>
<i>Upper oven temperature too hot or too cold</i>	Oven thermostat needs adjustment.	<ul style="list-style-type: none"> <li>See the <i>Adjust the oven thermostat—Do it yourself!</i> section.</li> </ul>
<i>Clock and timer do not work</i>	Plug on range is not completely inserted in the electrical outlet.	<ul style="list-style-type: none"> <li>Make sure electrical plug is plugged into a live, properly grounded outlet.</li> </ul>
	A fuse in your home may be blown or the circuit breaker tripped.	<ul style="list-style-type: none"> <li>Replace the fuse or reset the circuit breaker.</li> </ul>
	Oven controls improperly set.	<ul style="list-style-type: none"> <li>See the <i>Using the clock and timer</i> section.</li> </ul>
<i>Upper oven light does not work</i>	Light bulb is loose or defective.	<ul style="list-style-type: none"> <li>Tighten or replace the bulb.</li> </ul>
	Plug on range is not completely inserted in the electrical outlet.	<ul style="list-style-type: none"> <li>Make sure electrical plug is plugged into a live, properly grounded outlet.</li> </ul>
<i>Upper oven will not self-clean</i>	The oven temperature is too high to set a self-clean operation.	<ul style="list-style-type: none"> <li>Allow the range to cool to room temperature and reset the controls.</li> </ul>
	Oven controls improperly set.	<ul style="list-style-type: none"> <li>See the <i>Using the self-cleaning upper oven</i> section.</li> </ul>
<i>"Crackling" or "popping" sound</i>	This is the sound of the metal heating and cooling during both the cooking and cleaning functions.	<ul style="list-style-type: none"> <li>This is normal.</li> </ul>
<i>Excessive smoking</i>	Excessive soil.	<ul style="list-style-type: none"> <li>Touch the <b>CLEAR/OFF</b> pad. Open the windows to rid the room of smoke. Wait until the <b>LOCKED DOOR</b> light goes off. Wipe up the excess soil and reset the clean cycle.</li> </ul>
<i>Oven door will not open after a clean cycle</i>	Oven too hot.	<ul style="list-style-type: none"> <li>Allow the oven to cool below locking temperature.</li> </ul>

Problem	Possible Causes	What To Do
Oven not clean after a clean cycle	Oven controls not properly set. Oven was heavily soiled.	<ul style="list-style-type: none"> <li>See the <i>Using the self-cleaning oven</i> section.</li> <li>Clean up heavy spillovers before starting the clean cycle. Heavily soiled ovens may need to self-clean again or for a longer period of time.</li> </ul>
"LOCK DOOR" flashes in the display	The self-clean cycle has been selected but the door is not closed.	<ul style="list-style-type: none"> <li>Close the oven door.</li> </ul>
LOCKED DOOR light is on when you want to cook	The oven door is locked because the temperature inside the oven has not dropped below the locking temperature.	<ul style="list-style-type: none"> <li>Touch the <b>CLEAR/OFF</b> pad. Allow the oven to cool.</li> </ul>
"F—and a number or letter" flash in the display	You have a function error code. If the function code repeats.	<ul style="list-style-type: none"> <li>Touch the <b>CLEAR/OFF</b> pad. Allow the oven to cool for one hour. Put the oven back into operation.</li> <li>Disconnect all power to the range for 5 minutes and then reconnect power. If the function error code repeats, call for service.</li> </ul>
"Probe" appears in the display	This is reminding you to enter a probe temperature after plugging in the probe.	<ul style="list-style-type: none"> <li>Enter a probe temperature.</li> </ul>
Display goes blank	A fuse in your home may be blown or the circuit breaker tripped. The clock is in the black-out mode.	<ul style="list-style-type: none"> <li>Replace the fuse or reset the circuit breaker.</li> <li>See the <i>Special features of your oven control</i> section.</li> </ul>
Display flashes	Power failure.	<ul style="list-style-type: none"> <li>Reset the clock.</li> </ul>
Unable to get the display to show "SF"	Oven control pads were not pressed properly.	<ul style="list-style-type: none"> <li>The <b>BAKE</b> and <b>BROIL HI/LO</b> pads must be touched at the same time and held for 3 seconds.</li> </ul>
Power outage, clock flashes	Power outage or surge.	<ul style="list-style-type: none"> <li>Reset the clock. If the oven was in use, you must reset it by touching the <b>CLEAR/OFF</b> pad, setting the clock and resetting any cooking function.</li> </ul>
"Burning" or "oily" odor emitting from the vent	This is normal in a new oven and will disappear in time.	<ul style="list-style-type: none"> <li>To speed the process, set a self-clean cycle for a minimum of 3 hours. See the <i>Using the self-cleaning oven</i> section.</li> </ul>
Strong odor	An odor from the insulation around the inside of the oven is normal for the first few times the oven is used.	<ul style="list-style-type: none"> <li>This is temporary.</li> </ul>
LOC appears in the display	The Gas/Control Lockout feature is activated.	<ul style="list-style-type: none"> <li>Be sure the surface burner controls are turned OFF. Turn this feature off to use the range. See the <i>Gas/Control Lockout</i> section.</li> </ul>

## Before you call for service...



### Troubleshooting Tips

Problem	Possible Causes	What To Do
<b>Fan noise</b>	The convection fan may turn on and off automatically.	<ul style="list-style-type: none"> <li>This is normal. To maximize cooking evenness, the fan is designed to operate in both directions with a pause in between.</li> </ul>
<b>Convection fan not working</b>	Preheat temperature not reached.	<ul style="list-style-type: none"> <li>Fan will start automatically once the preheat temperature is reached.</li> </ul>
<b>Drawer does not slide smoothly or drags</b>	The drawer is out of alignment.	<ul style="list-style-type: none"> <li>Fully extend the drawer and push it all the way in. See the <i>Care and cleaning of the range</i> section.</li> </ul>
	Drawer is overloaded or load is unbalanced.	<ul style="list-style-type: none"> <li>Reduce weight. Redistribute drawer contents.</li> </ul>
<b>Lower oven drawer will not work</b>	A fuse in your home may be blown or the circuit breaker tripped.	<ul style="list-style-type: none"> <li>Replace the fuse or reset the circuit breaker.</li> </ul>
	The upper oven is self-cleaning.	<ul style="list-style-type: none"> <li>Wait for the self-clean cycle to finish and the oven to cool.</li> </ul>
	Controls improperly set.	<ul style="list-style-type: none"> <li>See the <i>Lower oven drawer</i> section.</li> </ul>
<b>Excessive condensation in the drawer</b>	Liquid in drawer.	<ul style="list-style-type: none"> <li>Remove liquid.</li> </ul>
	Uncovered foods.	<ul style="list-style-type: none"> <li>Cover food with lid or aluminum foil.</li> </ul>
	Temperature setting too high.	<ul style="list-style-type: none"> <li>Reduce temperature setting.</li> </ul>
<b>Food dries out in the lower oven drawer</b>	Moisture escaping.	<ul style="list-style-type: none"> <li>Cover food with lid or aluminum foil.</li> </ul>
	Oven drawer not fully closed.	<ul style="list-style-type: none"> <li>Push drawer in until latch engages.</li> </ul>



# Accessories.

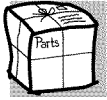

## Looking For Something More?

You can find these accessories and many more at [ge.com](http://ge.com) (U.S.) or [www.GEAppliances.ca](http://www.GEAppliances.ca) (Canada), or call 800.626.2002 (U.S.) or 888.261.3055 (Canada) (during normal business hours). Have your model number ready.

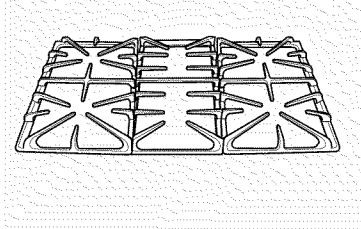

Grates

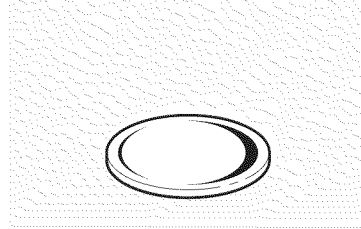

Surface Burner Caps

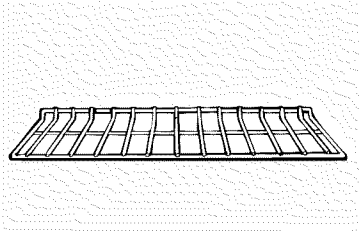

Oven and Drawer Racks

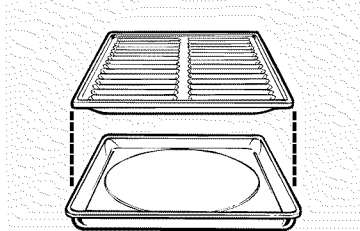

Broiler Pan

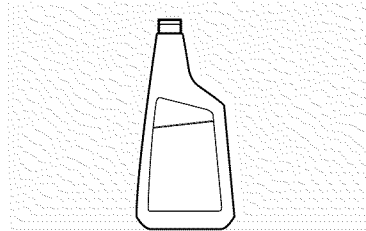

Cleaner

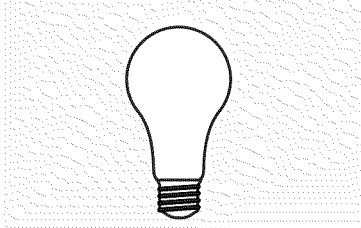

Light Bulbs

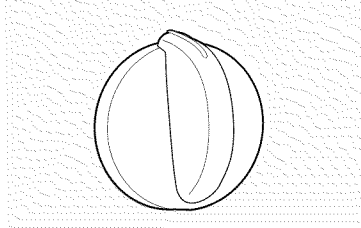

Knobs

Tired of discolored racks? Wishing you had extra-heavy-duty oven racks?

**NOW AVAILABLE** for your range:

GE's innovative, self-cleanable porcelain-coated oven racks!

- Heavy Duty
- Durable
- Able to be cleaned in a self-cleaning oven

Visit [ge.com](http://ge.com) (U.S.) or [www.GEAppliances.ca](http://www.GEAppliances.ca) (Canada) for more information.

<b>Consumer Support</b>	<b>Troubleshooting Tips</b>	<b>Installation Instructions</b>	<b>Operating Instructions</b>	<b>Safety Instructions</b>
-------------------------	-----------------------------	----------------------------------	-------------------------------	----------------------------

**Notes.**

---

## GE Service Protection Plus™

GE, a name recognized worldwide for quality and dependability, offers you Service Protection Plus™—comprehensive protection on all your appliances—**No Matter What Brand!**

**Benefits Include:**

- Backed by GE
- All brands covered
- Unlimited service calls
- All parts and labor costs included
- No out-of-pocket expenses
- No hidden deductibles
- One 800 number to call

***We'll Cover Any  
Appliance. Anywhere.  
Anytime.\****

You will be completely satisfied with our service protection or you may request your money back on the remaining value of your contract. No questions asked. It's that simple.

Protect your refrigerator, dishwasher, washer and dryer, range, TV, VCR and much more—**any brand!** Plus there's no extra charge for emergency service and low monthly financing is available. Even icemaker coverage and food spoilage protection is offered. You can rest easy, knowing that all your valuable household products are protected against expensive repairs.

Place your confidence in GE and call us in the U.S. toll-free at **800.626.2224** for more information.

\*All brands covered, up to 20 years old, in the continental U.S.

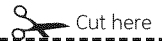

Please place in envelope and mail to:

***General Electric Company***  
**Warranty Registration Department**  
**P.O. Box 32150**  
**Louisville, KY 40232-2150**

# Consumer Product Ownership Registration

Dear Customer:

Thank you for purchasing our product and thank you for placing your confidence in us.

We are proud to have you as a customer!

Follow these three steps to protect your new appliance investment:

# 1

**Complete and mail your Consumer Product Ownership Registration today.** Have the peace of mind of knowing we can contact you in the unlikely event of a safety modification.

# 2

After mailing the registration below, store this document in a safe place. It contains information you will need should you require service. Our service number is 800.GE.CARES (800.432.2737).

# 3

Read your Owner's Manual carefully. It will help you operate your new appliance properly.

Model Number

Serial Number



**Important: If you did not get a registration card with your product, detach and return the form below to ensure that your product is registered, or register online at [ge.com](http://ge.com).**



## Consumer Product Ownership Registration



Model Number

Serial Number



Mr.  Ms.  Mrs.  Miss

First Name

Last Name

Street Address

Apt. #

E-mail Address\*

City

State

Zip Code

Date Placed In Use Month

Day

Year

Phone Number --



**GE Consumer & Industrial Appliances**  
General Electric Company  
Louisville, KY 40225  
[ge.com](http://ge.com)

\* Please provide your e-mail address to receive, via e-mail, discounts, special offers and other important communications from GE Appliances (GEA).

Check here if you do not want to receive communications from GEA's carefully selected partners.

FAILURE TO COMPLETE AND RETURN THIS CARD DOES NOT DIMINISH YOUR WARRANTY RIGHTS.

For information about GEA's privacy and data usage policy, go to [ge.com](http://ge.com) and click on "Privacy Policy" or call 800.626.2224.

# GE Dual Fuel Range Warranty. (For customers in the United States)



All warranty service provided by our Factory Service Centers, or an authorized Customer Care® technician. To schedule service, on-line, visit us at [ge.com](http://ge.com), or call 800.GE.CARES (800.432.2737). Please have serial number and model number available when calling for service.

Staple your receipt here.  
Proof of the original purchase date is needed to obtain service under the warranty.

## For The Period Of: GE Will Replace:

### One Year

From the date of the original purchase

**Any part** of the range which fails due to a defect in materials or workmanship. During this **limited one-year warranty**, GE will also provide, **free of charge**, all labor and in-home service to replace the defective part.

## What GE Will Not Cover:

- Service trips to your home to teach you how to use the product.
- Improper installation, delivery or maintenance.
- Failure of the product if it is abused, misused, or used for other than the intended purpose or used commercially.
- Replacement of house fuses or resetting of circuit breakers.
- Damage to the product caused by accident, fire, floods or acts of God.
- Incidental or consequential damage caused by possible defects with this appliance.
- Damage caused after delivery.
- Product not accessible to provide required service.

**EXCLUSION OF IMPLIED WARRANTIES—Your sole and exclusive remedy is product repair as provided in this Limited Warranty. Any implied warranties, including the implied warranties of merchantability or fitness for a particular purpose, are limited to one year or the shortest period allowed by law.**

This warranty is extended to the original purchaser and any succeeding owner for products purchased for home use within the USA. If the product is located in an area where service by a GE Authorized Servicer is not available, you may be responsible for a trip charge or you may be required to bring the product to an Authorized GE Service Location for service. In Alaska, the warranty excludes the cost of shipping or service calls to your home.

Some states do not allow the exclusion or limitation of incidental or consequential damages. This warranty gives you specific legal rights, and you may also have other rights which vary from state to state. To know what your legal rights are, consult your local or state consumer affairs office or your state's Attorney General.

Warrantor: General Electric Company. Louisville, KY 40225

Safety Instructions

Operating Instructions

Installation Instructions

Troubleshooting Tips

Consumer Support

# GE Dual Fuel Range Warranty. *(For customers in Canada)*

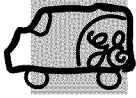

All warranty service provided by our Factory Service Centers or an authorized Customer Care® technician. For service, call 1.800.561.3344. Please have serial number and model number available when calling for service.

Staple your receipt here. Proof of the original purchase date is needed to obtain service under the warranty.

**For The Period Of:**      **Mabe Will Replace:**

**One Year**  
From the date of the original purchase

**Any part** of the range which fails due to a defect in materials or workmanship. During this **limited one-year warranty**, Mabe will also provide, **free of charge**, all labor and in-home service to replace the defective part.

**What Mabe Will Not Cover:**

- Service trips to your home to teach you how to use the product.
- Improper installation, delivery or maintenance.
- Failure of the product if it is abused, misused, or used for other than the intended purpose or used commercially.
- Replacement of house fuses or resetting of circuit breakers.
- Damage to the product caused by accident, fire, floods or acts of God.
- Incidental or consequential damage caused by possible defects with this appliance.
- Damage caused after delivery.
- Product not accessible to provide required service.

**EXCLUSION OF IMPLIED WARRANTIES—Your sole and exclusive remedy is product repair as provided in this Limited Warranty. Any implied warranties, including the implied warranties of merchantability or fitness for a particular purpose, are limited to one year or the shortest period allowed by law.**

WARRANTOR IS NOT RESPONSIBLE FOR CONSEQUENTIAL DAMAGES.

Warrantor: MABE CANADA INC.

Notes.

---

<i>Safety Instructions</i>	<i>Operating Instructions</i>	<i>Installation Instructions</i>	<i>Troubleshooting Tips</i>	<i>Consumer Support</i>
----------------------------	-------------------------------	----------------------------------	-----------------------------	-------------------------

## Consumer Support.

---



### GE Appliances Website

In the U.S.: **ge.com**

Have a question or need assistance with your appliance? Try the GE Appliances Website any day of the year! For greater convenience and faster service, you can now download Owner's Manuals, order parts or even schedule service on-line. **In Canada: [www.GEAppliances.ca](http://www.GEAppliances.ca)**

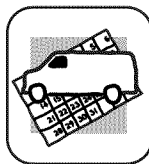

### Schedule Service

In the U.S.: **ge.com**

Expert GE repair service is only one step away from your door. Get on-line and schedule your service at your convenience 24 hours any day of the year! Or call 800.GE.CARES (800.432.2737) during normal business hours.

**In Canada, call 1.800.561.3344**

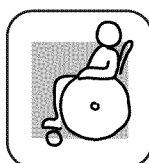

### Real Life Design Studio

In the U.S.: **ge.com**

GE supports the Universal Design concept—products, services and environments that can be used by people of all ages, sizes and capabilities. We recognize the need to design for a wide range of physical and mental abilities and impairments. For details of GE's Universal Design applications, including kitchen design ideas for people with disabilities, check out our Website today. For the hearing impaired, please call 800.TDD.GEAC (800.833.4322).

**In Canada, contact:** Manager, Consumer Relations, Mabe Canada Inc.  
Suite 310, 1 Factory Lane  
Moncton, N.B. E1C 9M3



### Extended Warranties

In the U.S.: **ge.com**

Purchase a GE extended warranty and learn about special discounts that are available while your warranty is still in effect. You can purchase it on-line anytime, or call 800.626.2224 during normal business hours. GE Consumer Home Services will still be there after your warranty expires. **In Canada, call 1.888.261.2133**

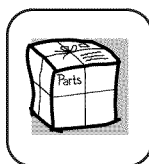

### Parts and Accessories

In the U.S.: **ge.com**

Individuals qualified to service their own appliances can have parts or accessories sent directly to their homes (VISA, MasterCard and Discover cards are accepted). Order on-line today, 24 hours every day or by phone at 800.626.2002 during normal business hours.

**Instructions contained in this manual cover procedures to be performed by any user. Other servicing generally should be referred to qualified service personnel. Caution must be exercised, since improper servicing may cause unsafe operation.**

Customers **in Canada** should consult the yellow pages for the nearest Mabe service center, or call 1.888.261.3055.



### Contact Us

In the U.S.: **ge.com**

If you are not satisfied with the service you receive from GE, contact us on our Website with all the details including your phone number, or write to:

General Manager, Customer Relations  
GE Appliances, Appliance Park  
Louisville, KY 40225

**In Canada: [www.GEAppliances.ca](http://www.GEAppliances.ca), or write to:** Director, Consumer Relations, Mabe Canada Inc.  
Suite 310, 1 Factory Lane  
Moncton, N.B. E1C 9M3



### Register Your Appliance

In the U.S.: **ge.com**

**Register your new appliance on-line—at your convenience!** Timely product registration will allow for enhanced communication and prompt service under the terms of your warranty, should the need arise. You may also mail in the pre-printed registration card included in the packing material. **In Canada: [www.GEAppliances.ca](http://www.GEAppliances.ca)**