

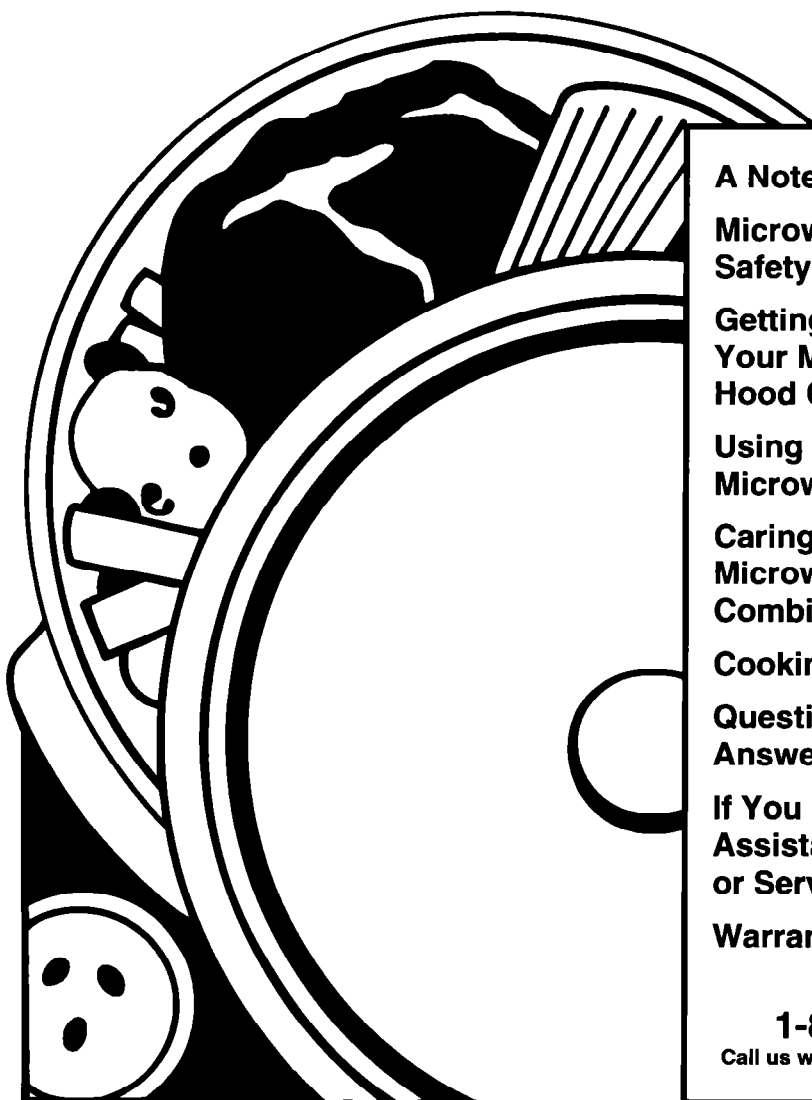

HOW TO MAKE A HOME RUN.™

Use And Care

G U I D E



A Note to You	2
Microwave Oven Safety	3
Getting to Know Your Microwave Hood Combination	8
Using Your Microwave Oven	20
Caring for Your Microwave Hood Combination	46
Cooking Guide	50
Questions and Answers	54
If You Need Assistance or Service	55
Warranty	60

1-800-253-1301

Call us with questions or comments.

MICROWAVE HOOD COMBINATION

PART NO. 3874W501067/4359223

7195

MODEL MH7110XB

A Note to You

Thank you for buying a WHIRLPOOL® appliance.

Because your life is getting busier and more complicated, WHIRLPOOL microwave ovens are easy to use, save time, and help you manage your home better. To ensure that you enjoy years of trouble-free operation, we developed this Use and Care Guide. It contains valuable information about how to operate and maintain your microwave oven properly and safely. Please read it carefully.

Also, please complete and mail in the Ownership Registration Card provided with your appliance. The card helps us notify you about any new information on your appliance.

Your safety is important to us.

This guide contains warning symbols and statements. Please pay special attention to this symbol and follow any instructions given. Here is a brief explanation of the use of the warning symbol.

⚠ WARNING

This symbol will help alert you to such dangers as fire, electrical shock, burns, and personal injury.

Our Consumer Assistance Center number, 1-800-253-1301, is toll-free, 24 hours a day.

If you ever have a question concerning your appliance's operation, or if you need service, first see "If You Need Assistance or Service" on page 55. If you need further help, feel free to call our Consumer Assistance Center. When calling, you will need to know your appliance's complete model number and serial number. You can find this information on the model and serial number plate (see diagram on page 10). For your convenience, we have included a handy place below for you to record these numbers, the purchase date from the sales slip, and your dealer's name and telephone number. Keep this book and the sales slip together in a safe place for future reference.

Model Number _____

Dealer Name _____

Serial Number _____

Dealer Phone _____

Purchase Date _____

Microwave Oven Safety

IMPORTANT SAFETY INSTRUCTIONS

Microwave ovens have been thoroughly tested for safe and efficient operation. However, as with any appliance, there are special installation and safety precautions which must be followed to ensure safe and satisfactory operation and prevent damage to the unit.

⚠ WARNING

To reduce the risk of fire, electrical shock, burns, injury to persons, exposure to excessive microwave energy, or damage when using the microwave oven, follow basic precautions, including the following:

- Read all instructions before using the microwave oven.
- Read and follow the specific "PRE-CAUTIONS TO AVOID POSSIBLE EXPOSURE TO EXCESSIVE MICROWAVE ENERGY" found on page 5.
- This appliance must be grounded. Connect only to properly grounded outlet. See "GROUNDING INSTRUCTIONS" found in the Installation Instructions.
- Install or locate this appliance only in accordance with the provided Installation Instructions.
- Some products such as whole eggs in the shell and sealed containers – for example, closed glass jars – could explode and should not be heated in this oven.
- Do not heat, store, or use flammable materials in or near the oven. Fumes could create a fire hazard or explosion.
- Use this appliance only for its intended use as described in this manual. Do not use corrosive chemicals or vapors in this appliance. This type of oven is specifically designed to heat or cook food. It is not designed for industrial or laboratory use.
- As with any appliance, close supervision is necessary when used by children.
- Do not operate this appliance if it is not working properly, or if it has been damaged. Electrical shock, fire, or other hazards could result.
- This appliance should be serviced only by qualified service personnel. Call an authorized Whirlpool service company for examination, repair, or adjustment.
- Do not cover or block any opening on the appliance. Fire could result.
- Do not store this appliance outdoors. Do not use this product near water – for example, near a kitchen sink, in a wet basement, or near a swimming pool, and the like.
- Do not immerse cord or plug in water.
- Keep cord away from heated surfaces.
- Do not let cord hang over edge of table or counter.
- This appliance is suitable for use above both gas and electric cooking equipment 36 inches or less wide.
- See door surface and interior cleaning instructions on page 46.
- To reduce the risk of fire in the oven cavity:
 - Do not overcook food. Carefully attend appliance if paper, plastic, or other combustible materials are placed inside the oven to facilitate cooking. Paper could char or burn, and some plastics could melt if used when heating foods.
 - Do not deep fry in oven. Microwavable utensils are not suitable and it is difficult to maintain appropriate deep frying temperatures.

continued on next page

MICROWAVE OVEN SAFETY

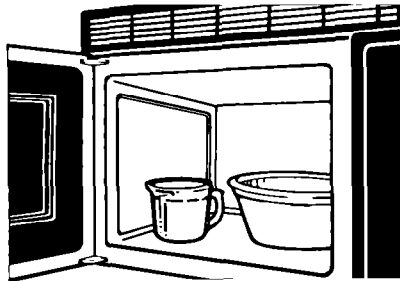

To reduce the risk of fire in the oven cavity (continued):

- **Test dinnerware or cookware before using.** To test a dish for safe use, put it into the oven with a cup of water beside it. Cook at 100% Cook Power for one minute. **If the dish gets hot and water stays cool, do not use it.** Some dishes (melamine, some ceramic dinnerware, etc.) absorb microwave energy, becoming too hot to handle and slowing cooking times. Cooking in metal containers not designed for microwave use could damage the oven, as could containers with hidden metal (twist-ties, foil lining, staples, metallic glaze or trim).
- Remove wire twist-ties from paper or plastic bags before placing bag in oven.

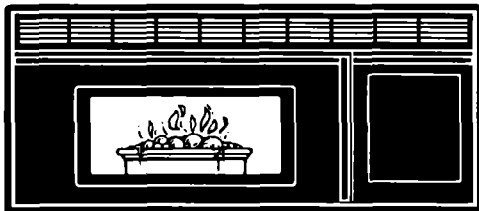

- If materials inside the oven should ignite, keep oven door closed, turn oven off, and disconnect the power cord or shut off power at the fuse or circuit breaker panel.

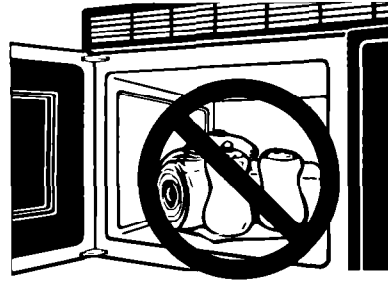

- Do not use the cavity for storage purposes. Do not leave paper products, cooking utensils, or food in the cavity when not in use.
- Because of the automatic exhaust fan feature, the following cautions must be observed:
 - Do not leave the area when using your cooktop at a high setting. Accidental fires from boilovers or spattering on the surface unit could spread, especially if the exhaust fan is operating.
 - Do not allow grease and soil to build up in the grease filter. Exhaust fan efficiency will decrease and fire could result. Clean often following the filter cleaning instructions on page 47.
 - Do not change the cooktop or oven lights without turning the power off at the main power supply (see page 48). Electrical shock could result.
 - Do not flame foods on a cooktop surface below this unit. The fan, if operating, could spread the flame and cause personal injury or property damage.
- Use care when cleaning the vent hood filter. Corrosive cleaning agents, such as lye-based oven cleaners, could damage filter.
- Read and follow “Operating safety precautions” starting on page 6.

MICROWAVE OVEN SAFETY

1. A short power-supply cord is provided to reduce the risks resulting from becoming entangled in or tripping over a longer cord.
2. Longer cord sets or extension cords are available and may be used if care is exercised in their use.
3. If a long cord or extension cord is used temporarily, (a) the marked electrical rating of the cord set or extension cord should be at least as great as the electrical rating of the appliance, (b) the extension cord must be a grounding-type, 3-wire cord that has a 3-blade grounding plug and a 3-slot receptacle that will accept the plug on the appliance, and (c) the longer cord should be arranged so that it will not drape over the countertop or tabletop where it can be pulled on by children or tripped over accidentally.
4. A qualified electrician must install a properly grounded and polarized 3-prong receptacle near the appliance.

- SAVE THESE INSTRUCTIONS -

PRECAUTIONS TO AVOID POSSIBLE EXPOSURE TO EXCESSIVE MICROWAVE ENERGY...

Do not attempt to operate this oven with the door open since open-door operation can result in harmful exposure to microwave energy. It is important not to defeat or tamper with the safety interlocks.

Do not place any object between the oven front face and the door or allow soil or cleaner residue to accumulate on sealing surfaces.

Do not operate the oven if it is damaged. It is particularly important that the oven door close properly and that there is no damage to the:

- (1) Door (bent),
- (2) Hinges and latches (broken or loosened),
- (3) Door seals and sealing surfaces.

Do not operate the microwave oven if the door window is broken.

The microwave oven should be checked for microwave leakage by qualified service personnel after a repair is made.

The oven should not be adjusted or repaired by anyone except properly qualified service personnel.

Do not operate the microwave oven with the outer cabinet removed.

MICROWAVE OVEN SAFETY

Operating safety precautions

⚠ WARNING

To reduce the risk of fire, electrical shock, burns, injury to persons, or damage when using the microwave oven, follow the precautions on pages 6-7.

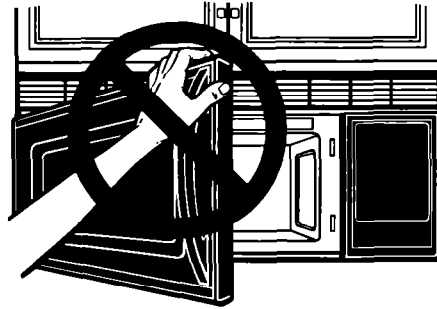

Never lean on the door or allow a child to swing on it when the door is open. Injury could result.

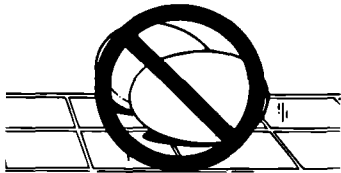

Never cook or reheat a whole egg inside the shell. Steam buildup in whole eggs may cause them to burst and burn you, and possibly damage the oven. **Slice** hard-boiled eggs before heating. In rare instances, poached eggs have been known to explode. **Cover** poached eggs and **allow** a standing time of one minute before cutting into them.

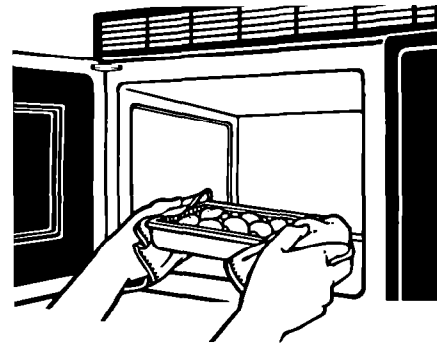

Use hot pads. Microwave energy does not heat containers, but the hot food does.



Stir before heating

For best results, stir any liquid several times before heating or reheating. Liquids heated in certain containers (especially cylindrical containers) may become overheated. The liquid may splash out with a loud noise during or after heating or when adding ingredients (coffee granules, tea bags, etc.) resulting in harm to the oven and possible personal injury.

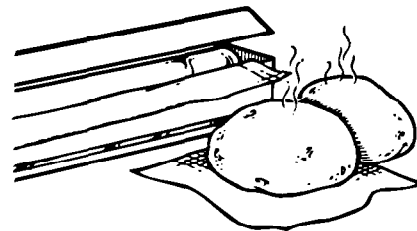

Do not overcook potatoes. Fire could result. At the end of the recommended cooking time, potatoes should be slightly firm because they will continue cooking during standing time. **After microwaving, wrap** potatoes in foil and **set aside** for five minutes. They will finish cooking while standing.

MICROWAVE OVEN SAFETY

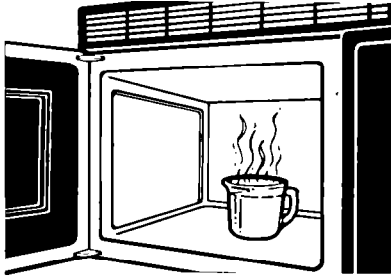

Do not start a microwave oven when it is empty. Product life may be shortened.

If you practice programming the oven, **put** a container of water in the oven.

It is normal for the inside of the oven door to look wavy after the oven has been running for a while.

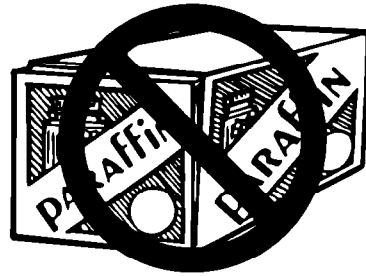

Do not try to melt paraffin wax in the oven. Paraffin wax will not melt in a microwave oven because it allows microwaves to pass through it.

General information

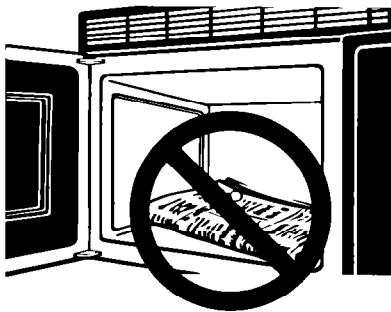

Do not use newspaper or other printed paper in the oven. Fire could result.

Do not dry flowers, fruit, herbs, wood, paper, gourds, or clothes in the oven. Fire could result.

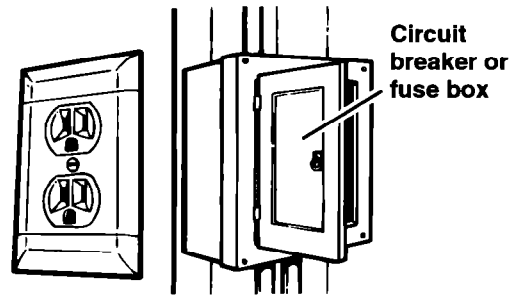

If your electrical power line or outlet voltage is less than 110 volts, cooking times may be longer. Have a qualified electrician check your electrical system.

Getting to Know Your Microwave Hood Combination

This section discusses the concepts behind microwave cooking and introduces you to the basics you need to know to operate your microwave oven. Please read this information before use.

In This Section	
Page	Page
How microwave cooking works 8	Using the cooktop/countertop light 15
Microwave oven features 10	Using the bi-level cooking rack 17
Control panel features 11	Setting the clock 18
Using the exhaust fan 14	Using the Minute Timer 19

How microwave cooking works

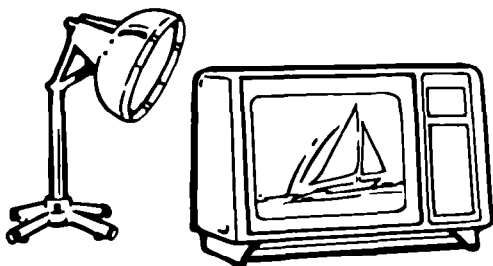

Microwave ovens are safe. Microwave energy is not hot. It causes food to make its own heat, and it's this heat that cooks the food.

Microwaves are like TV waves or light waves. You cannot see them, but you can see what they do.

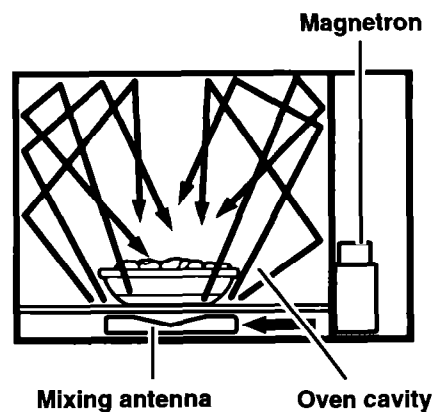

A magnetron in the microwave oven produces microwaves. The microwaves move into the area under the oven floor. There they bounce off the mixing antenna into the oven where they contact the food.

GETTING TO KNOW YOUR MICROWAVE HOOD COMBINATION

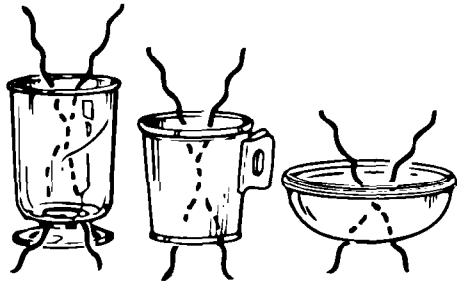

Microwaves pass through most glass, paper, and plastics without heating them so food absorbs the energy. Microwaves bounce off metal pans so food does not absorb the energy.

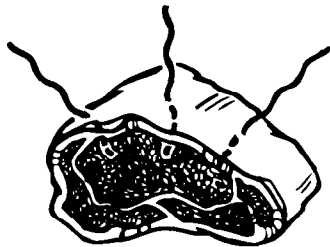

Microwaves may not reach the center of a roast. The heat spreads to the center from the outer, cooked areas just as in regular oven cooking. This is one of the reasons for letting some foods (for example, roasts or baked potatoes) stand for a while after cooking, or for stirring some foods during the cooking time.

The microwaves disturb water molecules in the food. As the molecules bounce around bumping into each other, heat is made, like rubbing your hands together. This is the heat that does the cooking.

Radio interference

Operation of the microwave oven may cause interference to your radio, TV, or similar equipment. When there is interference, it may be reduced or eliminated by taking the following measures:

- **Clean** door and sealing surfaces of the oven.
- **Adjust** the receiving antenna of radio or television.
- **Move** the receiver away from the microwave oven.
- **Plug** the microwave oven into a different outlet so that the microwave oven and receiver are on different branch circuits.

GETTING TO KNOW YOUR MICROWAVE HOOD COMBINATION

Microwave oven features

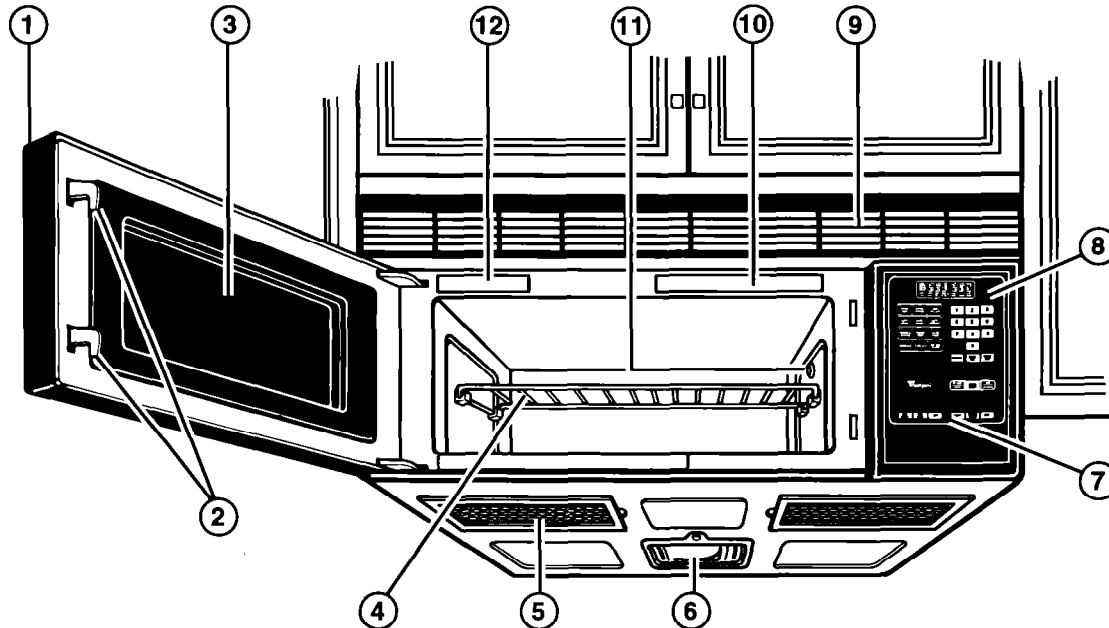

Your microwave oven is designed to make your cooking experience as enjoyable and productive as possible. To get you up and running quickly, the following is a list of the oven's basic features:

- 1. Door Handle.** Pull to open door.
- 2. Door Safety Lock System.** The oven will not operate unless the door is securely closed.
- 3. Window with Metal Shield.** Shield prevents microwaves from escaping. It is designed as a screen to allow you to view food as it cooks.
- 4. Two-Position Bi-Level Cooking Rack.** Use for extra space when cooking in more than one container at the same time. See page 17 for more information.
- 5. Filter.** See page 47 for cleaning information.
- 6. Cooktop/Countertop Light.** Turn on to light your cooktop or countertop or turn on as a night light. See page 15 for more information.
- 7. Exhaust Fan and Cooktop Light Switches.** See pages 14-17 for more information.
- 8. Control Panel.** Touch the pads on this panel to perform all functions. See pages 11-13 for more information.
- 9. Vent Grille.**
- 10. Cooking Guide.** Use as a quick reference for Auto Cook and Auto Defrost settings.
- 11. Temperature Probe Socket** (on oven wall). Plug the Temperature Probe into this socket when using probe for cooking. See page 33 for more information.
NOTE: Do not store the Temperature Probe in the oven when probe is not being used. Store in a handy place.
- 12. Model and Serial Number Plate.**

Smoke deflector accessory kit

A smoke deflector kit for your model is available from your Whirlpool parts dealer to use when installing this microwave oven over cooking products with a grill or griddle. Ask your Whirlpool dealer for details on Kit No. 4358523 – Smoke Deflector Kit.

GETTING TO KNOW YOUR MICROWAVE HOOD COMBINATION

Control panel features

Your microwave oven control panel lets you select the desired cooking function quickly and easily. All you have to do is touch the necessary Command Pad. The following is a list of all the Command and Number Pads located on the control panel. For more information, see pages 14-45.

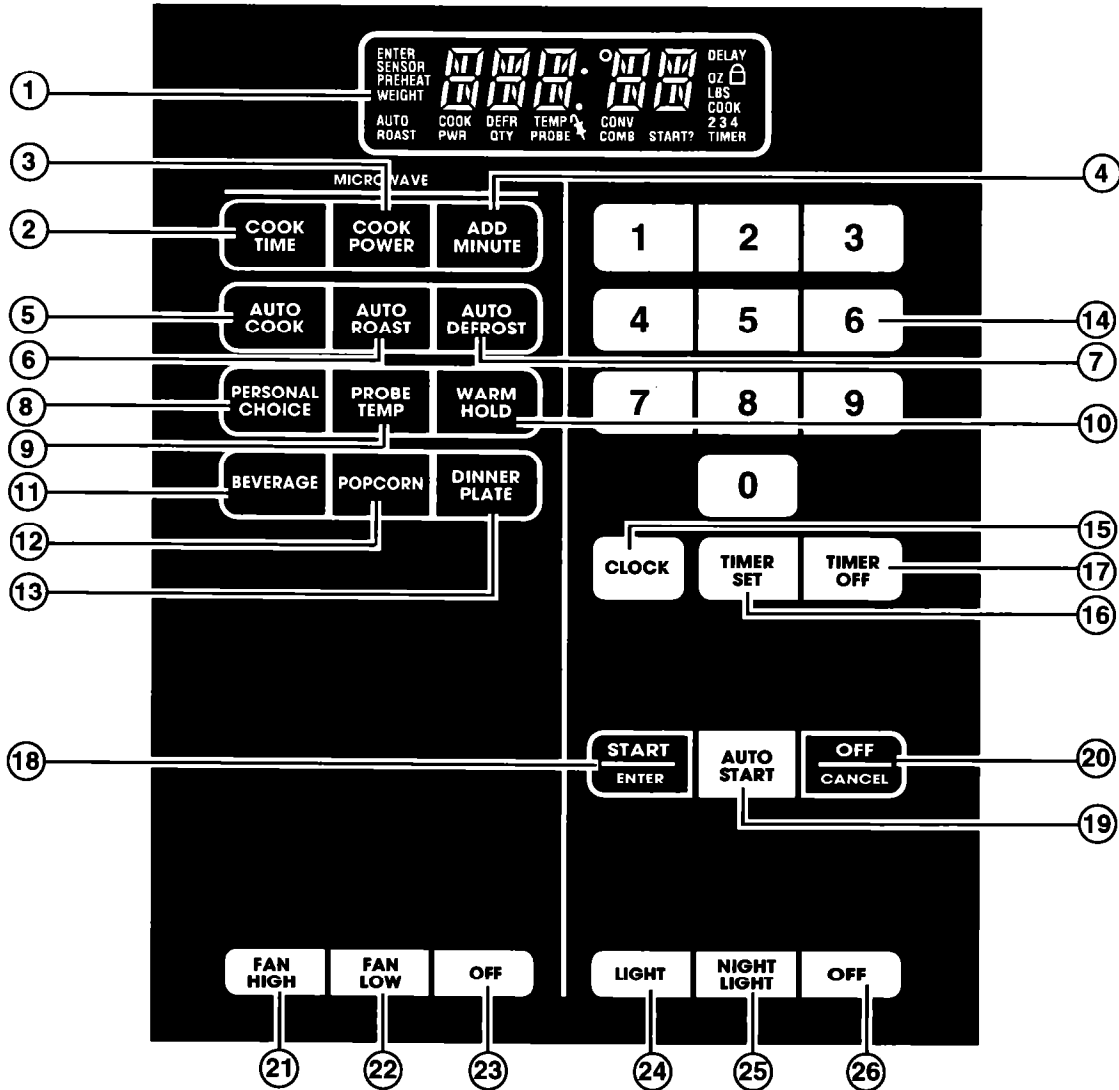

- 1. **Display.** The Display includes a clock and indicators to tell you time of day, cooking time settings, and cooking functions selected.
- 2. **COOK TIME.** Touch this pad followed by Number Pads to set a cooking time. See pages 21, 23, and 24 for more information.
- 3. **COOK POWER.** Touch this pad after the cook time has been set, followed by a

Number Pad to set the amount of microwave energy released to cook the food. The higher the number, the higher the microwave power or "cooking speed." See page 22 for more information. See the "Microwave cooking chart" on page 51 for specific Cook Powers to use for the foods you are cooking.

GETTING TO KNOW YOUR MICROWAVE HOOD COMBINATION

4. **ADD MINUTE.** Touch this pad to cook for one minute, at 100% Cook Power, or to add an extra minute, at the set Cook Power, to your cooking cycle. See page 44 for more information.
5. **AUTO COOK.** Touch this pad to cook common microwave-prepared foods without needing to program times and Cook Powers. See page 25 for more information.
6. **AUTO ROAST.** Touch this pad to roast with the Temperature Probe. See page 36 for more information.
7. **AUTO DEFROST.** Touch this pad followed by Number Pads to thaw frozen meat by weight. See page 27 for more information.
8. **PERSONAL CHOICE.** Touch this pad to recall one cooking instruction previously programmed into memory. See page 40 for more information.
9. **PROBE TEMP.** Touch this pad when using the Temperature Probe to cook. Touch PROBE TEMP followed by Number Pads to set desired final food temperature. See page 33 for more information.
10. **WARM HOLD.** Touch this pad to keep hot, cooked foods safely warm in your microwave oven for up to 99 minutes, 99 seconds. WARM HOLD can be used by itself, or it can automatically follow a cooking cycle. See page 32 for more information.
11. **BEVERAGE.** Touch this pad to reheat one-half cup or one cup of a beverage. The oven will automatically heat for a preset time at a preset Cook Power. See page 41 for more information.
12. **POPCORN.** Touch this pad when popping popcorn in your microwave oven. The oven will automatically heat for a preset time at a preset Cook Power. See page 43 for more information.
13. **DINNER PLATE.** Touch this pad to reheat a dinner-sized plate of refrigerated food. The oven will automatically heat for a preset time at preset Cook Powers. See page 42 for more information.
14. **Number Pads.** Touch Number Pads to enter cooking times, Cook Powers, temperatures, quantities, weights, or food categories.
15. **CLOCK.** Touch this pad to enter the correct time of day. See page 18 for more information.
16. **TIMER SET.** Touch this pad to set the Minute Timer. See page 19 for more information.
17. **TIMER OFF.** Touch this pad to cancel the Minute Timer. See page 19 for more information.
18. **START/ENTER.** Touch this pad to start a function. If you open the door after the oven begins to cook, retouch START/ENTER. See page 13 for more information.
19. **AUTO START.** Touch this pad to program your oven to begin cooking automatically at a chosen time later in the day. See page 38 for more information.
20. **OFF/CANCEL.** Touch this pad to erase an incorrect command, cancel a program during cooking, or to clear the Display. See page 13 for more information.
21. **FAN HIGH.** Touch this pad to turn on the fan at high speed. See page 14 for more information.
22. **FAN LOW.** Touch this pad to turn on the fan at low speed. See page 14 for more information.
23. **OFF.** Touch this pad to turn off the fan. See page 14 for more information.
24. **LIGHT.** Touch this pad to turn on the cooktop/countertop light. See page 15 for more information.

GETTING TO KNOW YOUR MICROWAVE HOOD COMBINATION

25. **NIGHT LIGHT.** Touch this pad to turn on the cooktop/countertop night light. See page 15 for more information.
26. **OFF.** Touch this pad to turn off the cooktop/countertop light. See page 16 for more information.

Audible signals

Audible signals are available to guide you when setting and using your oven:

- **A programming tone will sound** each time you touch a pad.
- **One long tone** signals the end of a Minute Timer countdown.
- **Four tones** signal the end of a cooking cycle.
- **Two tones** sound once every minute after an End-of-Cooking signal as a reminder if food has not been removed from oven.
- **Three tones** sound if you have made an incorrect entry.

To disable audible signals:

- **Touch and hold** Number Pad 1 for four seconds to disable programming tone and End-of-Cooking and End-of-Cycle signals.

OR

- **Touch and hold** Number Pad 2 for four seconds to disable all signals.

To turn signals back on:

Repeat steps under "To disable audible signals" above.

NOTE: Three tones, followed by two tones, will sound when audible signals are turned on or off. The three tones will be omitted if all tones are disabled.

Interrupting cooking

You can stop the oven during a cycle by opening the door. The oven stops heating and the fan stops, but the light stays on.

To restart cooking, close the door and

TOUCH



If you do not want to continue cooking:

- **Close** the door and the light goes off.

OR

- **TOUCH**



Using the demonstration feature

You can set your microwave oven to demonstrate its functions without turning the oven on.

NOTE: This feature can only be used when the microwave oven is first connected to power. You cannot use the demonstration feature after a Command Pad has been touched.

To set the demo feature:

1. **Open** the door and **keep** it open.
2. **Touch and hold** AUTO START for four seconds. Three tones, followed by two tones, will sound.
3. **Release** AUTO START.
4. **Shut** the door to start the demo.

To cancel the demo feature:

Touch OFF/CANCEL.

Using the safety lock

The safety lock prevents unwanted use of the microwave oven by disabling the control panel Command Pads.

To lock or deactivate the control panel:

Touch and hold Number Pad 3 for four seconds. Three tones, followed by two tones, will sound and  will appear on the Display.

To cancel the safety lock:

Touch and hold Number Pad 3 for four seconds. Two tones will sound and  will be cleared from the Display.

GETTING TO KNOW YOUR MICROWAVE HOOD COMBINATION

Using the exhaust fan

The three pads on the bottom left of the control panel control the 2-speed Exhaust Fan.



1. Choose fan speed.

NOTE: If the temperature gets too hot around the microwave oven, the exhaust fan in the vent hood will automatically turn on at the LOW setting to protect the oven. It may stay on up to an hour to cool the oven. When this occurs, the Fan OFF Pad will not turn the fan off.

TOUCH



OR



2. Turn off fan when desired.

TOUCH



To set fan to run for a specific time:

1. Start fan.

TOUCH



OR



2. Choose timer.

NOTE: If both the fan and light are operating and the TIMER Pad is touched twice, both the fan and light will be controlled by the timer. The Display will alternate between "FAN" and "LIGHT" one time before "STOP" is displayed.

TOUCH



twice within 3 seconds

YOU SEE

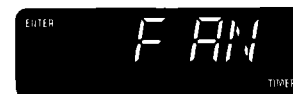

GETTING TO KNOW YOUR MICROWAVE HOOD COMBINATION

3. Set stop time.

Example to stop the fan at 5 o'clock, when time of day is 12 o'clock:

NOTE: You can set the stop time up to the next 12 hours.

TOUCH



YOU SEE



4. Start timer.

TOUCH



OR



YOU SEE



At end of time, the current time of day will show and no tones will sound.

To check the stop time:

The set time will be displayed for three seconds.

TOUCH



To cancel timer:

NOTE: Canceling the timer will cause the fan to shut off; however, canceling the fan will not cancel the timer.

TOUCH



Using the cooktop/countertop light

The three pads on the bottom right of the control panel control the cooktop/countertop light.



1. Turn on light.

TOUCH



OR



continued on next page

GETTING TO KNOW YOUR MICROWAVE HOOD COMBINATION

2. Turn off light when desired.

TOUCH



To set light to be on for a specific time:

1. Turn on light.

TOUCH



OR



2. Choose timer.

NOTE: If both the fan and light are operating and the TIMER Pad is touched twice, both the fan and light will be controlled by the timer. The Display will alternate between "FAN" and "LIGHT" one time before "STOP" is displayed.

TOUCH



twice within
3 seconds

YOU SEE



3. Set stop time.

Example to turn off light at 2 o'clock, when time of day is 12 o'clock:

NOTE: You can set the time up to the next 12 hours.

TOUCH

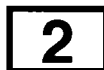

YOU SEE



4. Start timer.

TOUCH



OR



YOU SEE



At end of time, the current time of day will show and no tones will sound.

GETTING TO KNOW YOUR MICROWAVE HOOD COMBINATION

To check the stop time:

The set time will be displayed for three seconds.

TOUCH

TIMER
SET

To cancel timer:

NOTE: Canceling the timer will cause the light to shut off; however, canceling the light will not cancel the timer.

TOUCH

TIMER
OFF

Using the bi-level cooking rack

The Bi-Level Cooking Rack (Part No. 4358524) gives you extra space when cooking in more than one container at the same time. The metal rack can be turned upside-down to help fit taller containers on the bottom of the oven.

If you need a replacement rack and your Whirlpool dealer does not stock the rack, you can order it, by part number, by writing to:

Whirlpool Corporation
Attention: Customer Service Dept.
1900 Whirlpool Drive
LaPorte, IN 46350

Inserting the rack

First position

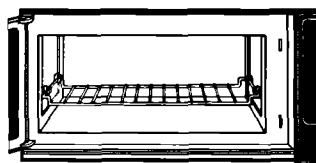

First position: Insert the rack securely into the rack supports on the side walls of the oven.

Second position

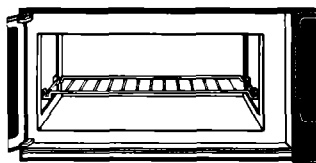

Second position: Turn rack upside-down when using a taller container on the bottom of the oven.

⚠ WARNING

Burn Hazard

Use hot pads when removing rack from oven after cooking.

Failure to do so could cause burns.

NOTES:

- **Do not store** the metal rack in the oven. Arcing and damage to the oven could result if someone accidentally starts the oven.
- **Do not operate** the oven with the metal rack stored on the floor of the oven. Damage to the interior finish will result.
- **Use rack** only in the microwave oven.
- **Do not use rack** with browning dish.
- **Do not let food** container on rack touch the top or sides of the oven.
- **Do not cook foods** directly on rack without putting them in containers first.
- **Do not place** a metal cooking container on rack. Place a microwave-safe plate under container.
- **Only use** the Bi-Level Cooking Rack when cooking at more than one level.

GETTING TO KNOW YOUR MICROWAVE HOOD COMBINATION

Setting the clock

When your microwave oven is first plugged in or after a power failure, the Display will show "888:88". For the first 30 seconds after the power is on, you can set the clock time without touching CLOCK. After 30 seconds has gone by, you must follow the directions below to set the time. If a time of day is not set, "888:88" will show on the Display until you touch CLOCK.

NOTES:

- **You can** only set the clock if the oven is not cooking food.
- **If you touch in** an incorrect time and touch CLOCK, three tones will sound. Enter the correct time.
- **If you touch** OFF/CANCEL while setting the clock, the Display will show the last time of day set or ":" if no time of day has been set.

To set time:

1. Choose setting.

TOUCH



YOU SEE



(for 3 seconds)

2. Enter time of day.

Example for 12:00:

TOUCH



YOU SEE



3. Complete entry.

TOUCH



OR



YOU SEE



GETTING TO KNOW YOUR MICROWAVE HOOD COMBINATION

Using the Minute Timer

You can use your microwave oven as a minute timer. Use the Minute Timer for timing up to 99 minutes, 99 seconds.

NOTE: The oven can operate while the Minute Timer is in use. To see the Minute Timer while the oven is cooking, touch **TIMER SET**. To return the Display to the cooking time countdown, touch **TIMER SET** again.

1. Touch **TIMER SET**.

TOUCH



YOU SEE



2. Enter time to be counted down.

Example for 1 minute, 30 seconds:

NOTE: If you enter more than 4 digits, three tones will sound. Touch **START/ENTER** to count down the 3-digit time you have entered or touch **TIMER OFF** to clear the Display. To start over, touch **TIMER SET** and re-enter desired time.

TOUCH

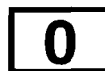
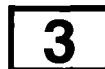

YOU SEE



3. Start countdown.

NOTE: If you do not do this step within three seconds of doing Step 2, "START?" will be displayed. You then have one minute to touch **START/ENTER** or **TIMER SET** before the Display returns to time of day.

TOUCH



OR



YOU SEE

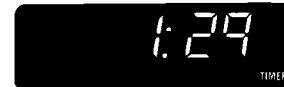

At end of countdown:

YOU SEE



(one tone will sound)

To cancel Minute Timer:

During countdown:

TOUCH



YOU SEE



After countdown:



(time of day)

Using Your Microwave Oven

This section gives you instructions for operating each function. Please read these instructions carefully.

In This Section			
	Page		Page
Getting the best cooking results	20	Cooking with the temperature probe	33
Cooking at high cook power	21	Using AUTO ROAST	36
Cooking at lower cook powers	22	Auto roast chart	37
Cooking with more than one cook cycle	24	Using AUTO START	38
Using AUTO COOK	25	Using PERSONAL CHOICE	40
Auto cook chart	26	Using BEVERAGE	41
Using AUTO DEFROST	27	Using DINNER PLATE	42
Auto defrost chart	29	Using POPCORN	43
Defrosting tips	31	Using ADD MINUTE	44
Using WARM HOLD	32	Adding or subtracting cook time	45

Getting the best cooking results

- **ALWAYS** cook food for the minimum recommended cooking time. If necessary, touch ADD MINUTE while the oven is operating or after it has completed the cooking cycle (see page 44 for more information). Then check for doneness to avoid overcooking the food.
- **Stir, turn over, or rearrange food** being cooked about halfway through the cook time for most even doneness with all recipes.
- **If a glass cover is not available, use** wax paper, paper towels, or microwave-approved plastic wrap. **Turn back** a corner to vent steam during cooking.
- **Although a new rating method*** rates this oven at 850 watts, you may use a reliable cookbook and recipes developed for microwave ovens previously rated at 700-800 watts.

* IEC-705 Test Procedure. The IEC-705 Test Procedure is an internationally recognized method of rating microwave wattage output and does not represent an actual change to output power or cooking performance.

USING YOUR MICROWAVE OVEN

Cooking at high cook power

1. Put food in oven and close the door.

2. Set cooking time.

TOUCH



YOU SEE



Example for 1 minute, 30 seconds:

TOUCH



YOU SEE



3. Start oven.

TOUCH



YOU SEE



At end of cooking time:

YOU SEE



Changing instructions

You can change the cooking time after cooking starts by repeating Steps 2 and 3.

USING YOUR MICROWAVE OVEN

Cooking at lower cook powers

For best results, some recipes call for lower Cook Powers. The lower the Cook Power, the slower the cooking. Each Number Pad also stands for a different percentage of Cook Power. Many microwave cookbook recipes tell you by number, percent, or name which Cook Power to use.

The following chart gives the percentage of Cook Power each Number Pad stands for, and the Cook Power name usually used. It also tells you when to use each Cook Power. Follow recipe or food package instructions if available.

COOK POWER	NAME	WHEN TO USE IT
Automatic 100% of full power	High	<ul style="list-style-type: none"> • Quick heating many convenience foods and foods with high water content, such as soups and beverages • Cooking tender cuts of meat, ground meat, poultry pieces, fish fillets, and vegetables
9=90% of full power		<ul style="list-style-type: none"> • Heating cream soups
8=80% of full power		<ul style="list-style-type: none"> • Heating rice, pasta, or casseroles
7=70% of full power	Medium-High	<ul style="list-style-type: none"> • Cooking and heating foods that need a Cook Power lower than high (for example, whole fish and meat loaf) or when food is cooking too fast • Reheating a single serving of food
6=60% of full power		<ul style="list-style-type: none"> • Cooking requiring special care, such as cheese and egg dishes, pudding, and custards • Finishing cooking casseroles
5=50% of full power	Medium	<ul style="list-style-type: none"> • Cooking ham, whole poultry, and pot roasts • Melting chocolate
4=40% of full power		<ul style="list-style-type: none"> • Simmering stews • Heating pastries
3=30% of full power	Medium-Low, Defrost	<ul style="list-style-type: none"> • Defrosting foods, such as bread, fish, meats, poultry, and precooked foods
2=20% of full power		<ul style="list-style-type: none"> • Softening butter, cheese, and ice cream
1=10% of full power	Low	<ul style="list-style-type: none"> • Keeping food warm • Taking chill out of fruit

NOTE: Once cook time has been entered you can also use the Cook Power pad as a second Minute Timer by entering "0" for the Cook Power. The oven will count down the cooking time you set without cooking.

USING YOUR MICROWAVE OVEN

1. Put food in oven and close the door.

2. Set cooking time.

TOUCH



YOU SEE



Example for 7 minutes, 30 seconds:

TOUCH



YOU SEE



3. Set Cook Power.

TOUCH



YOU SEE

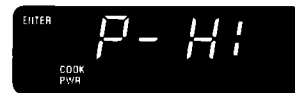

Example for 50% Cook Power:

TOUCH



YOU SEE

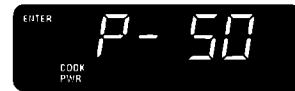

4. Start oven.

TOUCH



YOU SEE

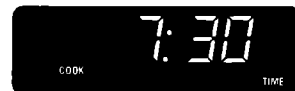

At end of cooking time:

YOU SEE



Changing instructions

You can change the cooking time or Cook Power after cooking starts by repeating Steps 2 and/or 3 and 4.

USING YOUR MICROWAVE OVEN

Cooking with more than one cook cycle

For best results, some recipes call for one Cook Power for a certain length of time, and another Cook Power for another length of time. Your oven can be set to change from one to another automatically, for up to two cycles.

1. Put food in oven and close the door.

2. Set cooking time for first cycle.

TOUCH

COOK
TIME

YOU SEE



Example for 7 minutes, 30 seconds:

TOUCH

7

3

0

YOU SEE



3. Set Cook Power for first cycle.

TOUCH

COOK
POWER

YOU SEE

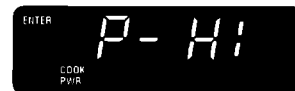

Example for 50% Cook Power:

TOUCH

5

YOU SEE

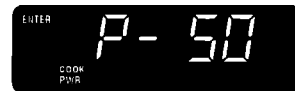

4. Repeat Steps 2 and 3 to set cooking time and Cook Power for the second cycle.

USING YOUR MICROWAVE OVEN

5. Start oven.

TOUCH



YOU SEE



(first cycle)

After the first cycle is over, the next cycle will count down.

At end of cooking time:

YOU SEE



Changing instructions

You can change times or Cook Powers for a cycle any time after that cycle starts by repeating Steps 2 and/or 3 and 4.

Using AUTO COOK

Cooking with AUTO COOK lets you cook common microwave-prepared foods without needing to program times and Cook Powers. AUTO COOK has preset times and Cook Powers for five major food categories: Casseroles, Baked Potatoes, Bread, Fresh/Canned Vegetables, and Frozen Vegetables. All you do is touch the Number Pad assigned

to the desired category and enter the number of items or servings being heated. Your microwave oven does the rest.

NOTE: See "Microwave cooking chart" on page 51 for cooking with Cook Power and cooking time.

1. Put food in oven and close the door.

2. Choose AUTO COOK.

TOUCH



YOU SEE



continued on next page

USING YOUR MICROWAVE OVEN

3. Choose food category.

Touch any of Number Pads 1-5.

NOTE: See "Auto cook chart" below or the Cooking Guide label on the frame behind the door for food categories available.

Example for Category 1 (casserole):

TOUCH



YOU SEE



Then:



4. Enter quantity/servings.

Example for 2 servings:

NOTE: If the quantity you entered is not correct, you can change it by touching AUTO COOK again and starting over.

TOUCH



YOU SEE

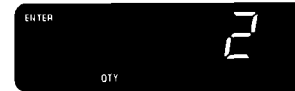

5. Start oven.

TOUCH



YOU SEE

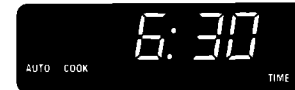

At end of cooking time:

YOU SEE



Auto cook chart

CATEGORY	FOOD	NUMBER OF SERVINGS/ITEMS YOU CAN COOK
1	Casserole	1-2
2	Baked Potatoes	1-4
3	Bread	1-2
4	Fresh/Canned Vegetables	1-4
5	Frozen Vegetables	1-4

USING YOUR MICROWAVE OVEN

Using AUTO DEFROST

Your microwave oven automatically defrosts a variety of common meats at preset Cook Powers for preset times. The 2-stage defrost cycle is programmed for meat, poultry, and fish. All you do is touch the Command Pad assigned to the desired category and enter the weight of the items being defrosted. Your microwave oven does the rest.

NOTES:

- See the "Auto defrost chart" on pages 29 and 30 for defrosting directions for each food.
- To defrost items not listed in "Auto defrost chart" on pages 29 and 30, use 30% Cook Power. Refer to a reliable cookbook for defrosting information.

1. Put frozen food in oven and close the door.

2. Choose AUTO DEFROST.

TOUCH



YOU SEE



3. Choose food category (1 for meat, 2 for poultry, 3 for fish).
Example for meat:

TOUCH



YOU SEE



Then:



4. Enter food's weight (in pounds and tenths of a pound).

Example for 1.2 lbs:

NOTES:

- For converting fractions of a pound to decimals, see "Weight conversion chart" on page 31.
- If you enter an incorrect weight, touch AUTO DEFROST again and enter the correct weight.

TOUCH



YOU SEE



continued on next page

USING YOUR MICROWAVE OVEN

5. Start oven.

TOUCH



YOU SEE



6. After half the cook time is over, Display will prompt you to turn over food.

Open door, turn over food, and shield any warm portions.

NOTE: If you do not open the door within two minutes, the Display will resume the countdown.

YOU SEE



7. Restart oven.

TOUCH



YOU SEE



(time remaining)

At end of defrosting time:

YOU SEE



USING YOUR MICROWAVE OVEN

Auto defrost chart

Meat setting

FOOD	AT PAUSE	SPECIAL INSTRUCTIONS
Beef		Meat of irregular shape and large, fatty cuts of meat should have the narrow or fatty areas shielded with foil at the beginning of a defrost cycle.
Ground Beef, Bulk	Remove thawed portions with fork. Turn over. Return remainder to oven.	Do not defrost less than 1/4 lb. Freeze in doughnut shape.
Ground Beef, Patties	Separate and rearrange.	Do not defrost less than two 4 oz patties. Depress center when freezing.
Round Steak	Turn over. Cover warm areas with aluminum foil.	Place on a microwavable roasting rack.
Tenderloin Steak	Turn over. Cover warm areas with aluminum foil.	Place on a microwavable roasting rack.
Stew Beef	Remove thawed portions with fork. Separate remainder. Return remainder to oven.	Place in a microwavable baking dish.
Pot Roast, Chuck Roast	Turn over. Cover warm areas with aluminum foil.	Place on a microwavable roasting rack.
Rib Roast	Turn over. Cover warm areas with aluminum foil.	Place on a microwavable roasting rack.
Rolled Rump Roast	Turn over. Cover warm areas with aluminum foil.	Place on a microwavable roasting rack.
Lamb		
Cubes for Stew	Remove thawed portions with fork. Return remainder to oven.	Place in a microwavable baking dish.
Chops (1 inch thick)	Separate and rearrange.	Place on a microwavable roasting rack.
Pork		
Chops (1/2 inch thick)	Separate and rearrange.	Place on a microwavable roasting rack.
Hot Dogs	Separate and rearrange.	Place on a microwavable roasting rack.
Spareribs, Country-Style Ribs	Turn over. Cover warm areas with aluminum foil.	Place on a microwavable roasting rack.
Sausage, Links	Separate and rearrange.	Place on a microwavable roasting rack.
Sausage, Bulk	Remove thawed portions with fork. Turn over. Return remainder to oven.	Place in a microwavable baking dish.
Loin Roast, Boneless	Turn over. Cover warm areas with aluminum foil.	Place on a microwavable roasting rack.

USING YOUR MICROWAVE OVEN

Auto defrost chart (continued)

Fish setting

FOOD	AT PAUSE	SPECIAL INSTRUCTIONS
Fish		
Fillets	Turn over. Separate fillets when partially thawed.	Place in a microwavable baking dish. Carefully separate fillets under cold water.
Steaks	Separate and rearrange.	Place in a microwavable baking dish. Run cold water over to finish defrosting.
Whole	Turn over.	Place in a microwavable baking dish. Cover head and tail with foil; do not let foil touch sides of microwave oven. Finish defrosting by immersing in cold water.
Shellfish		
Crabmeat	Break apart. Turn over.	Place in a microwavable baking dish.
Lobster Tails	Turn over and rearrange.	Place in a microwavable baking dish.
Shrimp	Separate and rearrange.	Place in a microwavable baking dish.
Scallops	Separate and rearrange.	Place in a microwavable baking dish.

Poultry setting

FOOD	AT PAUSE	SPECIAL INSTRUCTIONS
Chicken		
Whole (up to 9½ lbs)	Turn over (finish defrosting breast-side down). Cover warm areas with aluminum foil.	Place chicken breast-side up on a microwavable roasting rack. Finish defrosting by immersing in cold water. Remove giblets when chicken is partially defrosted.
Cut Up	Separate pieces and rearrange. Turn over. Cover warm areas with aluminum foil.	Place on a microwavable roasting rack. Finish defrosting by immersing in cold water.
Cornish Hens		
Whole	Turn over. Cover warm areas with aluminum foil.	Place on a microwavable roasting rack. Finish defrosting by immersing in cold water.
Turkey		
Breast (under 6 lbs)	Turn over. Cover warm areas with aluminum foil.	Place on a microwavable roasting rack. Finish defrosting by immersing in cold water.

USING YOUR MICROWAVE OVEN

Weight conversion chart

You are probably used to food weights as being in pounds and ounces that are fractions of a pound (for example 4 ounces equals $\frac{1}{4}$ pound). However, in order to enter food weight in AUTO DEFROST, you must specify pounds and tenths of a pound.

If the weight on the food package is in fractions of a pound, you can use the following chart to convert the weight to decimals.

NUMBER AFTER DECIMAL	EQUIVALENT OUNCE WEIGHT
.10	1.6
.20	3.2
.25 One-Quarter Pound	4.0
.30	4.8
.40	6.4
.50 One-Half Pound	8.0
.60	9.6
.70	11.2
.75 Three-Quarters Pound	12.0
.80	12.8
.90	14.4
1.00 One Pound	16.0

Defrosting tips

- **When using AUTO DEFROST**, the weight to be entered is the net weight in pounds and tenths of pounds (the weight of the food minus the container).
- **Only use AUTO DEFROST** for raw food. AUTO DEFROST gives best results when food to be thawed is a minimum of 0°F. If food has been stored in a refrigerator-freezer that does not maintain a temperature of 0°F or below, always program a lower food weight (for a shorter defrosting time) to prevent cooking the food.
- **If the food is kept outside** the freezer for up to 20 minutes, enter a lower food weight.
- **If the food is kept outside** the freezer for more than 20 minutes, and for defrosting ready-made food, defrost by time and power and let stand after defrosting.
- **The shape of the package** alters the defrosting time. Shallow rectangular packets defrost more quickly than a deep block.
- **Separate pieces** as they begin to defrost. Separated pieces defrost more easily.
- **You can use small pieces** of aluminum foil to shield foods like chicken wings, leg tips, and fish tails, but the foil must not touch the side of the oven. Foil can damage the oven lining.
- **Shield areas of food** with small pieces of foil if they start to become warm.
- **For better results, a preset standing time** is included in the defrosting time. This may make the defrosting time seem longer than expected. (For more information on standing time, see "Microwave cooking tips" on page 52.)

USING YOUR MICROWAVE OVEN

Using WARM HOLD

You can safely keep hot, cooked food warm in your microwave oven for up to 99 minutes, 99 seconds (about 1 hour, 40 minutes). You can use WARM HOLD by itself, or to automatically follow a cooking cycle.

NOTES:

- **WARM HOLD** operates for up to 99 minutes, 99 seconds.
- **Opening** the oven door cancels WARM HOLD. Close the door and touch WARM HOLD, then touch START/ENTER if additional WARM HOLD time is desired.
- **Food cooked covered** should be covered during WARM HOLD.
- **Pastry items** (pies, turnovers, etc.) should be uncovered during WARM HOLD.
- **Complete meals** kept warm on a dinner plate should be covered during WARM HOLD.
- **Do not use** more than one complete WARM HOLD cycle (about 1 hour, 40 minutes). The quality of some foods will suffer with extended time.

1. Put hot, cooked food in oven and close the door.

2. Choose setting.

TOUCH



YOU SEE



3. Start oven.

TOUCH



YOU SEE



To make WARM HOLD automatically follow another cycle:

- **While you are touching in cooking instructions**, touch WARM HOLD before touching START/ENTER.
- **When the last cooking cycle is over**, you will hear two tones. "WARM" will come on while the oven continues to run.
- **You can set WARM HOLD to follow** AUTO DEFROST, COOK, temperature probe cooking, or multi-cycle cooking.

Cooking with the temperature probe

The Temperature Probe helps take the guesswork out of cooking roasts and larger casseroles. The probe is designed to turn off the oven when it senses the temperature you chose (between 90°F and 200°F). See your cookbook for helpful information on cooking different types of food.

NOTE: If you have not plugged in the Temperature Probe properly or if probe is defective, "PROBE" will appear on the Display, three tones will sound, and the oven will not turn on. After correcting the problem or removing the probe, touch START/ENTER to clear the Display.

1. Insert probe into food.

Insert at least $\frac{1}{3}$ of the Temperature Probe into the food. (See page 35.)

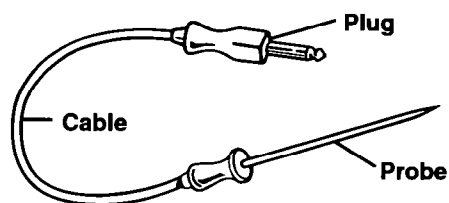

2. Place food in oven and plug probe into socket on oven wall.

Make sure the probe does not touch any part of the oven interior.

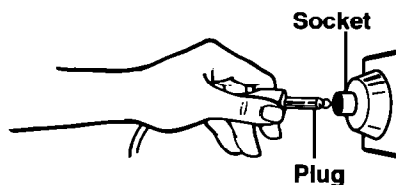

3. Close the door.

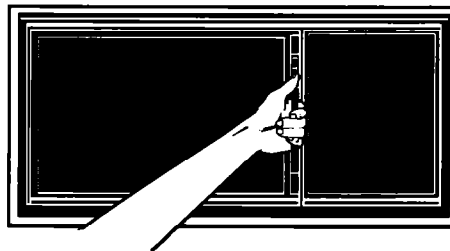

continued on next page

USING YOUR MICROWAVE OVEN

4. Choose setting.

NOTE: Food will automatically cook to 160°F if you do not specify a final food temperature. If you want to specify a final food temperature, do Step 5. Otherwise, skip to Step 6.

TOUCH

PROBE
TEMP

YOU SEE



5. Set desired final food temperature (optional).

Example for 180°:

TOUCH



YOU SEE



6. Start oven.

TOUCH

START
ENTER

YOU SEE



When food temperature reaches 90°F:
The displayed temperature will change each time food temperature increases by 5°F. If the temperature does not change after 20 minutes, the Display will show "CHECK" and "PROBE".

YOU SEE



When food reaches the desired temperature:

YOU SEE



To change final food temperature after oven has started:

1. Touch PROBE TEMP. You will see the current set temperature.
2. Re-enter desired temperature.
3. Touch START/ENTER.

NOTE: If you do not touch START/ENTER within one minute after entering the new temperature, the oven will resume heating to the first temperature you set. You can ensure that your new temperature is set by pressing PROBE TEMP (to display the set temperature for three seconds).

USING YOUR MICROWAVE OVEN

Temperature Probe cooking tips:

- **Stir** foods during cooking when recommended.
- **Stir** soups, casseroles, and drinks before serving.
- **Cover** roasts with foil after cooking and **let stand** a few minutes. **Remove** foil if you decide to cook it longer.
- **Remove** the probe from the oven when not cooking by temperature.

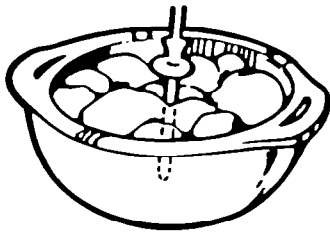

- **For casseroles**, the tip of the probe should be in the center of the food. **Stir** foods when recommended. **Replace** the probe.

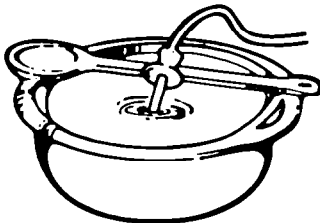

- **For liquids**, **balance** the probe on a wooden spoon or spatula so the tip of the probe is in the center of the liquid.

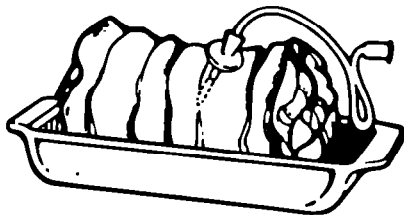

- **For roasts**, the tip of the probe should be in the center of the largest muscle, but not touching fat or bone.

- **Casseroles** cooked using the Temperature Probe should be made from precooked foods. **Do not use raw** meats, raw vegetables, and cream sauces in casseroles.
- **Dry casseroles** do not work well.
- **Thaw** frozen casseroles and meats in the microwave oven before inserting the probe.
- **If you are cooking** more than one individual serving at the same time, such as mugs of soup, **check** the probe setting in several of the items – all the mugs may not heat at the same rate.
- **Dry meat loaf** mixtures do not work well.
- **Check pork and poultry** with thermometer in 2-3 places to ensure adequate doneness.
- **Roasts may vary** in size, shape, and composition. **Use** the Temperature Probe as a guide.

Don't:

- **let probe or probe cable** touch any part of the oven interior.
- **let probe touch foil** (if used). You can keep foil away from probe with wooden toothpicks. **Remove** foil if arcing occurs.
- **use** paper, plastic wrap, or plastic containers. They will be in the oven too long and might distort.
- **force** probe into frozen food.
- **use** probe for food that needs to simmer.
- **plug** the pointed end of the Temperature Probe into the socket.

Removing and cleaning the Temperature Probe:

1. After oven has shut off, **unplug** the Temperature Probe using an oven mitt or hot pad.
2. **Wipe** probe with a hot, sudsy cloth and **dry** thoroughly. **Use** a plastic scouring pad to remove cooked-on foods.
3. **You can place** probe in the silverware basket of a dishwasher.

USING YOUR MICROWAVE OVEN

Using AUTO ROAST

AUTO ROAST lets you roast food with the Temperature Probe, without needing to enter a final food temperature. The probe will turn off the oven when it senses the preprogrammed final food temperature for the food category you chose.

1. Perform Steps 1, 2, and 3 under "Cooking with the temperature probe" on page 33.

2. Choose setting.

TOUCH



YOU SEE



3. Choose food category.

See "Auto roast chart" on page 37 for categories.

Example for Category 1
(Roast Beef [rare]):

TOUCH



YOU SEE



4. Start oven.

TOUCH



YOU SEE



When food temperature reaches 90°F:

The displayed temperature will change each time food temperature increases by 5°F. If the temperature does not change after 20 minutes, the Display will show "CHECK" and "PROBE".

When food reaches the desired temperature:

YOU SEE



YOU SEE



USING YOUR MICROWAVE OVEN

Auto roast chart

CATEGORY	FOOD	SPECIAL INSTRUCTIONS
1	Roast Beef (rare)	Put tip of probe in center of largest muscle, but not touching fat or bone. Shield top of roast with aluminum foil, sauce, or vegetables. Cover roast with foil after cooking and let stand a few minutes.
2	Roast Beef (medium)	Put tip of probe in center of largest muscle, but not touching fat or bone. Shield top of roast with aluminum foil, sauce, or vegetables. Cover roast with foil after cooking and let stand a few minutes.
3	Roast Beef (well)	Put tip of probe in center of largest muscle, but not touching fat or bone. Shield top of roast with aluminum foil, sauce, or vegetables. Cover roast with foil after cooking and let stand a few minutes.
4	Roast Pork (well)	Put tip of probe in center of largest muscle, but not touching fat or bone. Shield top of roast with aluminum foil, sauce, or vegetables. Cover roast with foil after cooking and let stand a few minutes.
5	Poultry	Shield the wing tips with aluminum foil. Check with thermometer in 2-3 places to ensure adequate doneness.
6	Casserole	Make casseroles from precooked foods. Position tip of probe in center of food. Stir before serving.

NOTE: Food to be roasted must be no less than .1 lb and no more than 9.9 lbs.

USING YOUR MICROWAVE OVEN

Using AUTO START

AUTO START lets you program your oven to begin cooking automatically at a time of day you choose. You can preprogram your oven up to 11 hours, 59 minutes in advance.

NOTES:

- **If you hear** the fan start when you touch START/ENTER, you have not set the oven properly. Touch OFF/CANCEL and start over.
- **You cannot use** AUTO START with ADD MINUTE, AUTO DEFROST, POPCORN, BEVERAGE, or DINNER PLATE.
- **Do not use** foods containing baking powder or yeast when using AUTO START. They will not rise properly.

⚠WARNING

Food Spoilage Hazard

Do not let most unfrozen food stand for more than two hours before cooking starts.

Do not allow food to remain in oven for more than two hours after the end of cooking cycle.

Failure to follow the above could result in sickness.

NOTE: Do not use foods that will spoil while waiting for cooking to start. Such foods are: dishes with milk or eggs, cream soups, and cooked meats or fish. Also, foods containing baking powder or yeast will not rise properly when cooked using auto start.

- 1. Put food in oven and close the door.**
- 2. Make sure clock is set to correct time of day.**

USING YOUR MICROWAVE OVEN

3. Choose setting.

TOUCH



YOU SEE



4. Set start time.

Example for 4:30:

TOUCH



YOU SEE



5. Enter cooking instructions for the function you want.

(cooking at high power or lower power, temperature probe cooking, AUTO COOK, PERSONAL CHOICE, WARM HOLD)

6. Complete entry.

TOUCH



YOU SEE



(time of day)

The oven will start cooking at the set time.

NOTE: If the door is opened before the start time is reached, the Display will show "DOOR" and "OPEN" for five minutes or until the door is closed, whichever comes first. You must touch START/ENTER to resume AUTO START.

At end of cooking time:

YOU SEE

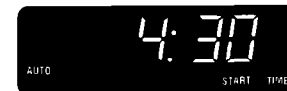

YOU SEE



USING YOUR MICROWAVE OVEN

Using PERSONAL CHOICE

PERSONAL CHOICE allows you to recall one cooking instruction previously placed in memory and begin cooking quickly. For example, if you heat a roll every morning, program the cooking steps into PERSONAL CHOICE. You can heat your roll each morning by touching PERSONAL CHOICE.

PERSONAL CHOICE also allows you to program a function for another person to cook at a later time.

NOTE: You can reprogram PERSONAL CHOICE by repeating the instructions below. A power failure will erase your Personal Choice program.

To program PERSONAL CHOICE:

1. Choose PERSONAL CHOICE.

TOUCH

PERSONAL
CHOICE

for 4 seconds

YOU SEE

ENTER
PR CM

2. Set cooking time.

TOUCH

COOK
TIME

Example for 20 seconds:

TOUCH

2 0

YOU SEE

ENTER
COOK
TIME

YOU SEE

ENTER
COOK
:20
TIME

3. Set Cook Power.

TOUCH

COOK
POWER

Example for 50% Cook Power:

TOUCH

5

YOU SEE

ENTER
COOK
PWR
P-41

YOU SEE

ENTER
COOK
PWR
P-50

4. Complete entry.

TOUCH

PERSONAL
CHOICE

YOU SEE

12:00

(time of day)

USING YOUR MICROWAVE OVEN

To use **PERSONAL CHOICE**:

1. Put food in oven and close the door.

2. Choose **PERSONAL CHOICE**.

The oven will cook according to your preprogrammed instructions.

TOUCH



YOU SEE



(display counts down programmed cooking time)

At end of cooking time:

YOU SEE



Using **BEVERAGE**

BEVERAGE lets you heat a beverage by touching just one pad.

NOTE: If you want to change the heating time after choosing **BEVERAGE**, see "Adding or subtracting cook time" on page 45.

1. Place cup of beverage in oven and close the door.

2. Choose **BEVERAGE**.

To heat a half cup of a beverage:

TOUCH



once

YOU SEE



To heat a full cup of a beverage:

TOUCH



twice

YOU SEE



continued on next page

USING YOUR MICROWAVE OVEN

In three seconds, the Display will start counting down.

Example for full cup:

YOU SEE



At end of heating time:

YOU SEE



Using DINNER PLATE

DINNER PLATE lets you reheat a dinner-size plate of refrigerated food. Place meat and bulky vegetables to the outside of the plate. Cover with wax paper.

NOTE: If you want to change the heating time after choosing DINNER PLATE, see "Adding or subtracting cook time" on page 45.

1. Place plate of food in oven and close the door.

-
2. Choose DINNER PLATE.

TOUCH

DINNER
PLATE

YOU SEE



After 3 seconds:

At end of first stage, two tones will sound.

YOU SEE



At end of heating time:

YOU SEE



After one minute:



USING YOUR MICROWAVE OVEN

Using POPCORN

POPCORN lets you pop commercially packaged microwave popcorn by touching just one pad. Pop only one package at a time. If you are using a microwave popcorn popper, follow manufacturer's instructions. You can set your microwave oven to pop different size bags of popcorn. You specify the setting by the number of times you touch POPCORN. To correctly set your microwave oven, follow this chart:

Bag Size – ounces	3.5	1.75
Touch POPCORN	once	twice

Cooking performance may vary with brand. Try several brands to decide which gives best popping results. For best results, use fresh bags of popcorn.

NOTE: If you want to change the popping time after choosing POPCORN, see "Adding or subtracting cook time" on page 45.

1. Place bag in oven and close the door.

2. Choose POPCORN.

Example for 3.5 oz regular bags:

TOUCH



once

YOU SEE



After 3 seconds, oven starts popping popcorn:

YOU SEE

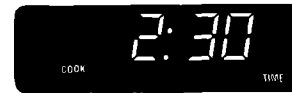

(time counts down)

⚠ WARNING

Fire Hazard

Do not repop unpopped kernels and do not reuse popcorn bags. Doing so could result in fire.

continued on next page

USING YOUR MICROWAVE OVEN

Every 10 seconds the Display will alternate between "POP-" and "CORN" and then show the time remaining.

YOU SEE



(time remaining)

At end of popping time:

YOU SEE



Using ADD MINUTE

ADD MINUTE lets you cook food for one minute at 100% Cook Power or add an extra minute to your cooking cycle. You can also use it to extend cooking time in multiples of one minute, up to 99 minutes.

NOTES:

- **To extend** cooking time in multiples of one minute, touch ADD MINUTE repeatedly during cooking.
- **You can enter** ADD MINUTE only after closing the door, after touching OFF/CANCEL, or during cooking.

- **If you touch** ADD MINUTE during cooking, the oven will cook at the currently selected Cook Power. If you touch ADD MINUTE after cooking is over, the oven will cook at 100% Cook Power.
- **You cannot use** ADD MINUTE with POPCORN, AUTO COOK, or AUTO DEFROST.
- **You cannot use** ADD MINUTE to start the oven if any program, other than the Minute Timer, is on the Display.

1. Make sure food is in oven.

2. Choose ADD MINUTE.

Example for cooking for one minute:

TOUCH



YOU SEE



Adding or subtracting cook time

If a preset cook time is too long or too short, you can increase or decrease the cook time by 10% after choosing the function. You can only increase or decrease cook time before cooking starts.

To increase cook time by 10%:

TOUCH



YOU SEE



(example for auto cook)

To decrease cook time by 10%:

TOUCH



YOU SEE



To reset to the original cook time:

TOUCH



YOU SEE



Caring for Your Microwave Hood Combination

To make sure your microwave oven looks good and works well for a long time, you should maintain it properly. For proper care, please follow these instructions carefully.

Cleaning the microwave oven

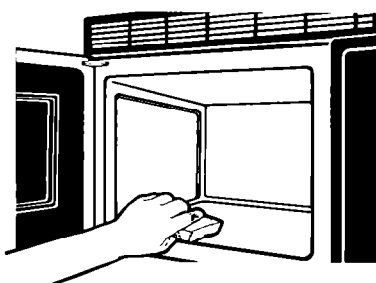

For interior surfaces: Wipe often with warm, sudsy water and a sponge or soft cloth. Use only mild, nonabrasive soaps or a mild detergent. Be sure to keep the areas clean where the door and oven frame touch when closed. Wipe well with clean water.

For exterior surfaces and control panel: Use a soft cloth with spray glass cleaner. Apply spray glass cleaner to soft cloth; do not spray directly on oven.

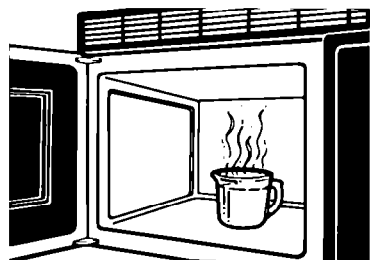

For stubborn soil, **boil** a cup of water in the oven for 2 or 3 minutes. Steam will soften the soil. To get rid of odors inside the oven, **boil** a cup of water with lemon juice or vinegar.

NOTE: Abrasive cleansers, steel-wool pads, gritty wash cloths, some paper towels, etc., can damage the control panel and the interior and exterior oven surfaces.

Cleaning the bi-level cooking rack

- **Wash by hand** with a mild detergent and a soft or nylon scrub brush. Dry completely.
- **Do not use** abrasive scrubbers or cleansers to clean rack.

CARING FOR YOUR MICROWAVE HOOD COMBINATION

Caring for the filters

The grease filters should be removed and cleaned often, at least once a month.

NOTE: If your microwave hood combination is installed to recirculate air, the charcoal filter (Part No. 4358792) should be replaced every 6-12 months. The charcoal filter cannot be cleaned.

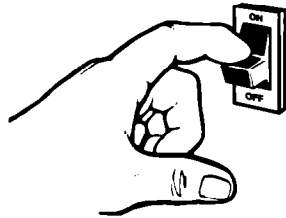

1. For your personal safety, **turn off** the electric power at the main power supply.

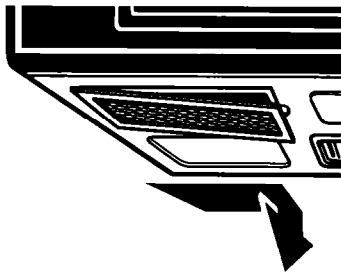

2. To remove grease filters, **slide** each filter to the side. **Pull** filters downward and **push** to the other side. The filter will drop out.

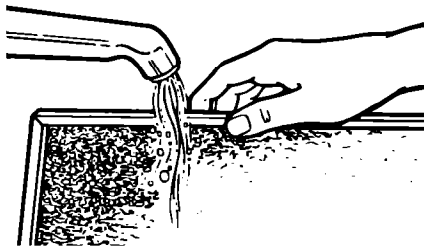

3. **Soak** grease filters in hot water and a mild detergent. **Scrub and swish** to remove embedded dirt and grease.

Rinse well and shake to dry. Do not use ammonia or place in a dishwasher. The aluminum will darken.



4. To replace grease filters, **slide** filter in the frame slot on one side of the opening. **Push** filter upward and **push** to the other side to lock into place.

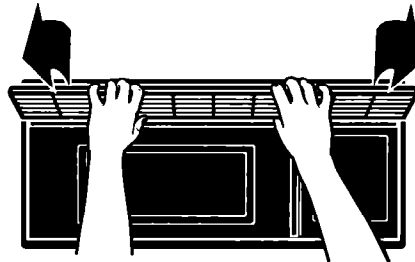

5. To remove charcoal filter: **remove** the vent cover mounting screws.
6. **Tip** the cover forward, then **lift out** to remove.

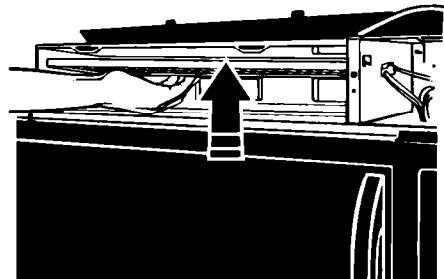

7. **Lift** the back of the charcoal filter. **Slide** the filter straight out.

continued on next page

CARING FOR YOUR MICROWAVE HOOD COMBINATION

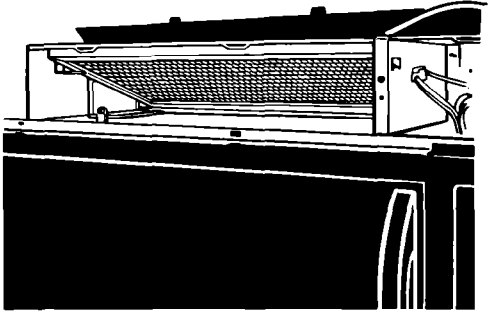

8. **Slide** a new charcoal filter into place. The filter should rest at the angle shown.

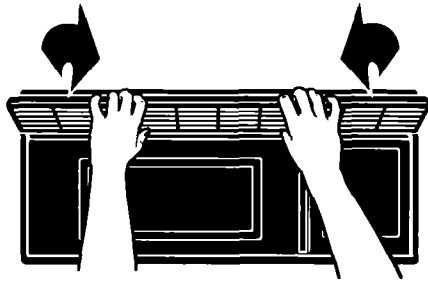

9. **Slide** the bottom of the vent cover into place. **Push** the top until it snaps into place. **Replace** the mounting screws.

10. **Turn** the power back on at the main power supply.



11. **Do not operate** the hood without the filters in place.

Replacing the cooktop and oven lights

⚠ WARNING

Fire Hazard

Use only candelabra-base bulbs, 30-watt maximum.

Turn off power at main power supply before replacing the light bulb.

Failure to follow the above could result in fire or electrical shock.

The cooktop light

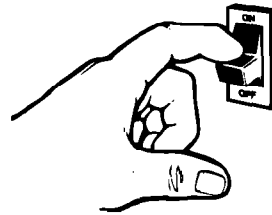

1. **Turn off** power at the main power supply.

CARING FOR YOUR MICROWAVE HOOD COMBINATION

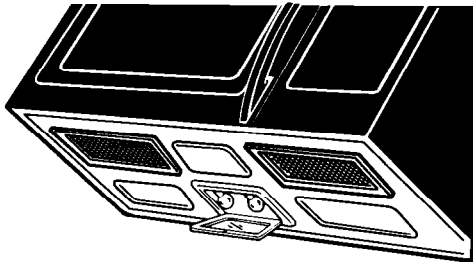

2. **Remove** the bulb cover mounting screws.
3. We recommend replacing bulb(s) with candelabra-base 30-watt bulb(s) available from your authorized Whirlpool service company (Part No. 4158432).
4. **Turn** the power back on at the main power supply.

The oven light

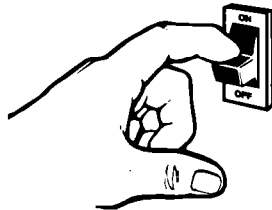

1. **Turn off** power at the main power supply.

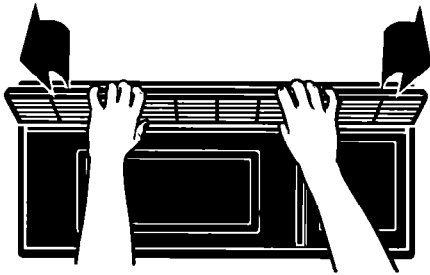

2. **Remove** the vent cover mounting screws.
3. **Tip** the cover forward, then **lift out** to remove.

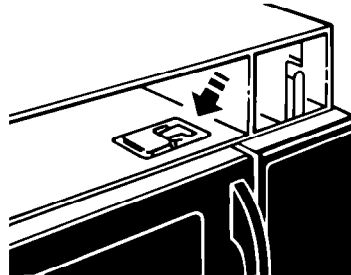

4. **Remove** bulb holder mounting screw.

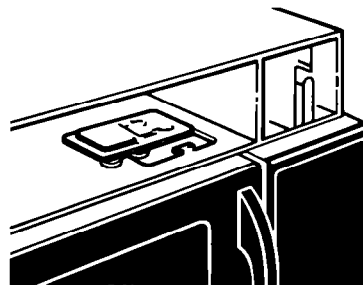

5. **Lift up** the bulb holder.
6. We recommend replacing the bulb with a candelabra-base 30-watt bulb available from your authorized Whirlpool service company (Part No. 4158432).
7. **Replace** the bulb holder and mounting screw.

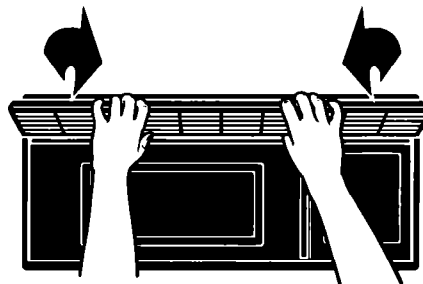

8. **Slide** the top of the vent cover into place. **Push** the bottom until it snaps into place. **Replace** the mounting screws. **Turn** the power back on at the main power supply.

Cooking Guide

Reheating chart

Times are approximate and may need to be adjusted to individual taste.

ITEM	STARTING TEMP	TIME/POWER	PROCEDURE
Meat (Chicken pieces, chops, hamburgers, meat loaf slices) 1 serving 2 servings	Refrigerated Refrigerated	1-2 min at 70% 2½-4½ min at 70%	Cover loosely.
Meat Slices (Beef, ham, pork, turkey) 1 or more servings	Room temp Refrigerated	45 sec-1 min per serving at 50% 1-3 min per serving at 50%	Cover with gravy or wax paper. Check after 30 sec per serving.
Stirrable Casseroles and Main Dishes 1 serving 2 servings 4-6 servings	Refrigerated Refrigerated Refrigerated	2-4 min at 100% 4-6 min at 100% 6-8 min at 100%	Cover. Stir after half the time.
Nonstirrable Casseroles and Main Dishes 1 serving 2 servings 4-6 servings	Refrigerated Refrigerated Refrigerated	5-8 min at 50% 9-12 min at 50% 13-16 min at 50%	Cover with wax paper.
Soup, Cream 1 cup 1 can (10¾ oz)	Refrigerated Room temp	3-4½ min at 50% 5-7 min at 50%	Cover. Stir after half the time.
Soup, Clear 1 cup 1 can (10¾ oz)	Refrigerated Room temp	2½-3½ min at 100% 4-5½ min at 100%	Cover. Stir after half the time.
Pizza 1 slice 1 slice 2 slices 2 slices	Room temp Refrigerated Room temp Refrigerated	15-25 sec at 100% 30-40 sec at 100% 30-40 sec at 100% 45-55 sec at 100%	Place on paper towel.
Vegetables 1 serving 2 servings	Refrigerated Refrigerated	¾-1½ min at 100% 1½-2½ min at 100%	Cover. Stir after half the time.
Baked Potato 1 2	Refrigerated Refrigerated	1-2 min at 50% 2-3 min at 50%	Cut potato lengthwise and then several times crosswise. Cover with wax paper.
Breads (Dinner or breakfast roll) 1 roll 2 rolls 4 rolls	Room temp Room temp Room temp	8-12 sec at 50% 11-15 sec at 100% 18-22 sec at 100%	Wrap single roll, bagel, or muffin in paper towel. To reheat several, line plate with paper towel. Cover with another paper towel.
Pie Whole 1 slice	Refrigerated Refrigerated	5-7 min at 70% 30 sec at 100%	

Microwave cooking chart

Times are approximate and may need to be adjusted to individual taste. **NOTE:** See "Using AUTO COOK" on page 25 for cooking without Cook Powers or cooking times.

MEATS, POULTRY, FISH, SEAFOOD Allow standing time after cooking.			VEGETABLES (continued) Cook at 100% cook power.		
FOOD	COOK POWER	TIME	FOOD	TIME	
Bacon (per slice)	100%	45 sec to 1 min 15 sec per slice	Cauliflower (medium head)	6-9 min	
Ground Beef for Casse-roles (1 lb)	100%	4-6 min	Corn on the Cob (2) (4)	4-9 min 6-16 min	
Hamburger Patties (2)	100%	1st side 2 min 2nd side 1½ to 2½ min	Potatoes, Baked (4 medium)	13-19 min	
Hamburger Patties (4)	100%	1st side 2½ min 2nd side 2-3 min	Squash, Summer (1 lb)	3-8 min	
Meat Loaf (1½ lbs)	100%	13-19 min	OTHER		
Chicken Pieces Internal temperature should be 185°F after standing.	100%	6-9 min/lb	FOOD	COOK POWER	TIME
Turkey Breast Internal temperature should be 185°F after standing.	100% then 70%	5 min 8-12 min/lb	Applesauce (4 servings)	100%	7-10 min
Fish Fillets (1 lb)	100%	5-6 min	Baked Apples (4)	100%	4-6 min
Scallops and Shrimp (1 lb)	100%	3½-5½ min	Chocolate (melt 1 square)	50%	1-2 min
VEGETABLES Cook at 100% cook power.			Eggs, Scrambled (2) (4)	100%	1 min 15 sec to 1 min 45 sec 2-3 min
FOOD		TIME	Hot Cereals (1 serving) (4 servings)	100%	1½-5 min 4½-7 min
Beans, Green or Yellow (1 lb)		6-12 min	Nachos (large plate)	50%	1½-2½ min
Broccoli (1 lb)		6-10 min	Water for Beverage (1 cup) (2 cups)	100%	2½-4 min 4½-6 min
Carrots (1 lb)		8-12 min			

Microwave cooking tips

Amount of food

- **The more food** you prepare, the longer it takes. A rule of thumb is that a double amount of food requires almost double the time. If one potato takes four minutes to cook, you need about seven minutes to cook two potatoes.
- **If you want to cook two meals or containers of food** at the same time, you can do so with the Bi-Level Cooking Rack. For example, you can cook two frozen dinners or reheat two plates of food by placing one on the rack and one under the rack.

Starting temperature of food

- **The lower the temperature** of the food being put into the microwave oven, the longer it takes to cook. Food at room temperature will be reheated more quickly than food at refrigerator temperature.

Composition of food

- **Food with a lot of fat and sugar** will be heated faster than food containing a lot of water. Fat and sugar will also reach a higher temperature than water in the cooking process.
- **The more dense the food**, the longer it takes to heat. "Very dense" food like meat takes longer to reheat than lighter, more porous food like sponge cakes.

Size and shape

- **Smaller pieces of food** will cook faster than larger pieces and same-shaped pieces of food cook more evenly than irregularly-shaped foods.
- **With unevenly shaped foods**, the thinner parts will cook faster than the thicker areas. **Place** the thinner parts of chicken wings and legs in the center of the dish.

Stirring, turning foods

- **Stirring and turning foods** distributes heat quickly to the center of the dish and avoids overcooking at the outer edges of the food.

Covering food

Cover food to:

- **Reduce** splattering
- **Shorten** cooking times
- **Retain** food moisture

All coverings that allow microwaves to pass through are suitable.

Releasing pressure in foods

- **Several foods** (for example: baked potatoes, sausages, egg yolks, and some fruits) are tightly covered by a skin or membrane. This can cause the food to burst from steam building up in them during cooking. To relieve the pressure and to prevent bursting, **prick** these foods before cooking with a fork, cocktail pick, or toothpick.

Using standing time

- **Always allow food to stand** for a while after cooking. Standing time after defrosting, cooking, or reheating always improves the result since the temperature will then be evenly distributed throughout the food.
- **When cooking in a microwave oven**, food continues to cook even when the microwave energy is turned off. Food is no longer cooked by microwaves, but it is still being cooked by the high heat left over from the microwave oven.
- **The length of the standing time** depends on the volume and density of the food. Sometimes it can be as short as the time it takes you to remove the food from the oven and take it to the serving table. However, with larger, denser food, the standing time may be as long as 10 minutes.

Arranging food

For best results, distribute food evenly on the plate. You can do this in several ways:

- **If you are cooking several items of the same food**, such as baked potatoes, **place** them in a ring pattern for uniform cooking.
- **When cooking foods of uneven shapes or thickness**, **place** the smaller or thinner area of the food towards the center of the dish where it will be heated last.
- **Arrange uneven foods**, such as fish, in the oven with the tails to the center.
- **If you are saving a meal in the refrigerator** or “plating” a meal for reheating, **arrange** the thicker, denser foods to the outside of the plate and the thinner or less dense foods in the middle.
- **Place thin slices of meat** on top of each other or interlace them.
- **Place thicker slices of meat**, such as meat loaf and sausages, close to each other.
- **Reheat gravy or sauce** in a separate container.
- **When you cook or reheat whole fish**, **score** the skin – this prevents cracking.
- **Shield the tail and head of whole fish** with small pieces of foil to prevent overcooking and ensure the foil does not touch the sides of the oven.
- **Do not** let food or container touch the top or sides of the oven. This will prevent possible arcing.

Using aluminum foil

Metal containers usually should not be used in a microwave oven. There are, however, some exceptions. If you have purchased food which is prepackaged in an aluminum foil container, then refer to the instructions on the package. When using aluminum foil containers, cooking times may be longer because microwaves will only penetrate the top of the food.

If you use aluminum containers without package instructions, follow these guidelines:

- **Place** container in a glass bowl and add some water so that it covers the bottom of the container, not more than ¼" high. This ensures even heating of the container bottom.
- **Always remove** the lid to avoid damage to the oven.
- **Use only** undamaged containers.
- **Do not use** containers taller than ¾".
- **Container must be** half filled.
- **To avoid sparking**, there must be a minimum ¼" between the aluminum container and the walls of the oven and also between two aluminum containers.
- **Reheating food** in aluminum foil containers usually takes up to double the time compared to reheating in plastic, glass, china, or paper containers. The time when food is ready will vary a great deal.
- **Let food stand** for 2-3 minutes after heating so that heat is spread evenly throughout container.

Cooking you should not do in your microwave oven

- **Do not** do canning of foods in the oven. Closed glass jars may explode, resulting in damage to the oven or possible personal injury.
- **Do not** use the microwave oven to sterilize objects (baby bottles, etc.). It is difficult to maintain the high temperature required for safe sterilization.

Questions and Answers

QUESTIONS	ANSWERS
Can I use a rack in my microwave oven so that I may reheat or cook on two levels at a time?	You can use a rack only if the rack is supplied with your microwave oven. Use of any rack not supplied with the microwave oven can result in poor cooking performance and/or arcing.
Can I use either metal or aluminum pans in my microwave oven?	Useable metal includes aluminum foil for shielding (use small, flat pieces), small skewers, and shallow foil trays (if tray is $\frac{3}{4}$ inch deep and filled with food to absorb microwave energy). Never allow metal to touch walls or door. (For more information, see page 53.)
Sometimes the door of my microwave oven appears wavy. Is this normal?	This appearance is normal and does not affect the operation of your oven.
What are the humming noises that I hear when my microwave oven is operating?	You hear the sound of the transformer when the magnetron tube cycles on.
Why does the dish become hot when I microwave food in it? I thought that this should not happen.	As the food becomes hot it will conduct the heat to the dish. Be prepared to use hot pads to remove food after cooking.
What does "standing time" mean?	"Standing time" means that food should be taken out of the oven and covered for additional time after cooking. This process allows the cooking to finish, saves energy, and frees the oven for another purpose.
Can I pop popcorn in my microwave oven? How do I get the best results?	Yes. Pop packaged microwave popcorn following manufacturer's guidelines or use the preprogrammed POPCORN pad. Do not use regular paper bags. Use the "listening test" by stopping the oven as soon as the popping slows to a "pop" every one or two seconds. Do not repop unpopped kernels. You can also use special microwave poppers. When using a popper, be sure to follow manufacturer's directions. Do not pop popcorn in glass utensils.
Why does steam come out of the air exhaust vent?	Steam is normally produced during cooking. The microwave oven has been designed to vent this steam out the top vent.

If You Need Assistance or Service

This section is designed to help you save the cost of a service call. Part 1 of this section outlines possible problems, their causes, and actions you can take to solve each problem. Parts 2 and 3 tell you what to do if you still need assistance or service. When calling our Consumer Assistance Center for help or calling for service, please provide a detailed description of the problem, your appliance's complete model and serial numbers, and the purchase date. (See page 2.) This information will help us respond properly to your request.

1. Before calling for assistance ...

Performance problems often result from little things you can find and fix without tools of any kind. Please check the chart below for problems you can fix. It could save you the cost of a service call.

PROBLEM	POSSIBLE CAUSE	SOLUTION
Nothing will operate	<p>The unit is not wired into a live circuit with the proper voltage.</p> <p>A household fuse has blown or a circuit breaker has tripped.</p> <p>The electric company has experienced a power failure.</p>	<p>Contact a qualified Whirlpool service technician to wire unit into a live circuit with the proper voltage. (See Installation Instructions.)</p> <p>Replace household fuse or reset circuit breaker.</p> <p>Check electric company for a power failure.</p>
The microwave oven will not run	<p>You are using the oven as a timer.</p> <p>If you are using the Temperature Probe, probe is not plugged tightly into its socket.</p> <p>The door is not firmly closed and latched.</p> <p>You did not touch START/ENTER.</p> <p>You did not follow directions exactly.</p> <p>An operation that was programmed earlier is still running.</p>	<p>Touch TIMER OFF to cancel the Minute Timer.</p> <p>Plug Temperature Probe tightly into its socket.</p> <p>Firmly close and latch door.</p> <p>Touch START/ENTER.</p> <p>Check instructions for the function you are operating.</p> <p>Touch OFF/CANCEL to cancel previous programming.</p>

continued on next page

IF YOU NEED ASSISTANCE OR SERVICE

PROBLEM	POSSIBLE CAUSE	SOLUTION
Microwave cooking times seem too long	<p>The electric supply to your home or wall outlets is low or lower than normal.</p> <p>The Cook Power is not at the recommended setting.</p> <p>There is not enough cooking time for the amount of food being cooked.</p>	<p>Your electric company can tell you if the line voltage is low. Your electrician or service technician can tell you if the outlet voltage is low.</p> <p>Check "Microwave cooking chart" on page 51.</p> <p>Allow for more time when cooking more food at one time.</p>
The Display shows a time counting down but the oven is not cooking	<p>The oven door is not closed completely.</p> <p>You have set the controls as a Minute Timer.</p>	<p>Completely close oven door.</p> <p>Touch TIMER OFF to cancel the Minute Timer.</p>
You do not hear the Programming Tone	<p>The command is not correct.</p>	<p>Re-enter command.</p>
The microwave oven turns off too soon or not soon enough when using the Temperature Probe	<p>Probe is not pushed far enough into the food.</p> <p>Probe is not positioned correctly in the food.</p> <p>When cooking roasts, you have not let roast stand after cooking.</p> <p>Probe is not plugged in correctly.</p> <p>Cook Power is not set correctly.</p> <p>Probe temperature is not set correctly.</p>	<p>Insert at least $\frac{1}{3}$ of probe into the food.</p> <p>Position probe tip in the center of the food.</p> <p>Allow roast to stand for a few minutes after cooking.</p> <p>Plug probe tightly into its socket.</p> <p>Reset the Cook Power.</p> <p>Reset the probe temperature.</p>
The Display shows "888:88"	<p>There has been a power interruption.</p>	<p>Reset the clock.</p>

IF YOU NEED ASSISTANCE OR SERVICE

2. If you need assistance ...

Call the Whirlpool Consumer Assistance Center telephone number. Dial toll-free from anywhere in the U.S.A.:

1-800-253-1301

and talk with one of our trained consultants. The consultant can instruct you in how to obtain satisfactory operation from your appliance or, if service is necessary, recommend a qualified service company in your area.

If you prefer, write to:

Mr. William Clark
Consumer Assistance Representative
Whirlpool Corporation
2000 North M-63
Benton Harbor, MI 49022-2692

Please include a daytime phone number in your correspondence.

3. If you need service ...



Whirlpool has a nationwide network of authorized Whirlpool service companies. Whirlpool service

technicians are trained to fulfill the product warranty and provide after-warranty service, anywhere in the United States. To locate the authorized Whirlpool service company in your area, call our Consumer Assistance Center telephone number (see Step 2) or look in your telephone directory Yellow Pages under:

• APPLIANCE-HOUSEHOLD-MAJOR, SERVICE & REPAIR

- See: Whirlpool Appliances or Authorized Whirlpool Service
(Example: XYZ Service Co.)

• WASHING MACHINES & DRYERS, SERVICE & REPAIR

- See: Whirlpool Appliances or Authorized Whirlpool Service
(Example: XYZ Service Co.)

4. If you are not satisfied with how the problem was solved ...

- Contact the Major Appliance Consumer Action Program (MACAP). MACAP is a group of independent consumer experts that voices consumer views at the highest levels of the major appliance industry.
- Contact MACAP only when the dealer, authorized servicer, and Whirlpool have failed to resolve your problem.
Major Appliance Consumer Action Program
20 North Wacker Drive
Chicago, IL 60606
- MACAP will in turn inform us of your action.

WHIRLPOOL®

Microwave Oven Warranty

LENGTH OF WARRANTY	WHIRLPOOL WILL PAY FOR
FULL ONE-YEAR WARRANTY From Date of Purchase	FSP® replacement parts and repair labor to correct defects in materials or workmanship. Service must be provided by an authorized Whirlpool service company.
LIMITED FOUR-YEAR WARRANTY Second Through Fifth Year From Date of Purchase	FSP replacement magnetron tube on microwave ovens if defective in materials or workmanship.
WHIRLPOOL WILL NOT PAY FOR	
<p>A. Service calls to:</p> <ol style="list-style-type: none"> 1. Correct the installation of your microwave oven. 2. Instruct you how to use your microwave oven. 3. Replace house fuses or correct house wiring. 4. Replace owner-accessible light bulbs. <p>B. Repairs when your microwave oven is used in other than normal, single-family household use.</p> <p>C. Pickup and delivery. Your microwave oven is designed to be repaired in the home.</p> <p>D. Damage to your microwave oven caused by accident, misuse, fire, flood, acts of God, or use of products not approved by Whirlpool.</p> <p>E. Any labor costs during limited warranty.</p> <p>F. Repairs to parts or systems caused by unauthorized modifications made to the appliance.</p>	

5/93

WHIRLPOOL CORPORATION SHALL NOT BE LIABLE FOR INCIDENTAL OR CONSEQUENTIAL DAMAGES. Some states do not allow the exclusion or limitation of incidental or consequential damages, so this exclusion or limitation may not apply to you. This warranty gives you specific legal rights, and you may also have other rights which vary from state to state.

Outside the United States, a different warranty may apply. For details, please contact your authorized Whirlpool distributor or military exchange.

If you need service, first see the "If You Need Assistance or Service" section of this book. After checking "If You Need Assistance or Service," additional help can be found by calling our Consumer Assistance Center telephone number, **1-800-253-1301**, from anywhere in the U.S.A.