



GE Profile Convection/Microwave Oven

Safety Instructions2-6

Operating Instructions

Bake Features 10, 18, 20

Best Method of Cooking Chart21

Changing Power Level 14

Cooking Options10

Cookware Tips20

Fast Bake Feature10, 19, 20

Features of Your Oven 8, 9

Microwave Terms 14

Other Features23-25

 Auto Recipe™ Conversion18, 24

 Automatic Fan25

 Auto Nite Light24

 Bake Temp. Adjust24

 Beeper Volume24

 Child Lock-Out23

 Clear/Off23

 Clock23

 Cooking Complete Reminder ...23

 Display Language24

 Display ON/OFF24

 Display Speed24

 Help23

 Measures25

 More Time Message25

 Resume23

 Start/Pause23

 Surface Light25

 Timer25

 Turntable On/Off25

 Vent Fan25

Roast Features 10, 18, 20

Sensor Features 15-17

Time and Auto Features 9, 11-13

Warm Feature 22

Care and Cleaning

Charcoal Filters29

Inside26

Outside26

Replacing the Light Bulbs27

Stainless Steel27

Vent Filters28, 29

Troubleshooting Tips 30, 31

Things That Are Normal
With Your Microwave Oven 32

Consumer Support

Consumer Support Back Cover

Optional Kits7

Product Registration 33, 34

Warranty 35

Español

For a Spanish version of this manual, visit our Website at www.GEAppliances.com.

Para consultar una version en español de este manual de instrucciones, visite nuestro sitio de internet ge.com.

Owner's Manual
JVM1790

Write the model and serial numbers here:

Model # _____

Serial # _____

You can find them on a label when the door is open.



IMPORTANT SAFETY INSTRUCTIONS. READ ALL INSTRUCTIONS BEFORE USING.

⚠ **WARNING!**

For your safety, the information in this manual must be followed to minimize the risk of fire, explosion, electric shock, exposure to excessive microwave energy, or to prevent property damage, personal injury, or loss of life.

PRECAUTIONS TO AVOID POSSIBLE EXPOSURE TO EXCESSIVE MICROWAVE ENERGY

- (a) **Do Not Attempt** to operate this oven with the door open since open-door operation can result in harmful exposure to microwave energy. It is important not to defeat or tamper with the safety interlocks.
- (b) **Do Not Place** any object between the oven front face and the door or allow soil or cleaner residue to accumulate on sealing surfaces.
- (c) **Do Not Operate** the oven if it is damaged. It is particularly important that the oven door close properly and that there is no damage to the:
 - (1) door (bent),
 - (2) hinges and latches (broken or loosened),
 - (3) door seals and sealing surfaces.
- (d) **The Oven Should Not** be adjusted or repaired by anyone except properly qualified service personnel.

IMPORTANT SAFETY INSTRUCTIONS.

When using electrical appliances basic safety precautions should be followed, including the following:

- Read and follow the specific precautions in the **PRECAUTIONS TO AVOID POSSIBLE EXPOSURE TO EXCESSIVE MICROWAVE ENERGY** section above.
- This appliance must be grounded. Connect only to a properly grounded outlet. See the **GROUNDING INSTRUCTIONS** section on page 6.
- Install or locate this appliance only in accordance with the provided Installation Instructions.
- This microwave oven is UL listed for installation over electric and gas ranges.
- This microwave oven is not approved or tested for marine use.
- This over-the-range oven is designed for use over ranges no wider than 36". It may be installed over both gas and electric cooking equipment.
- Do not operate this appliance if it has a damaged power cord or plug, if it is not working properly, or if it has been damaged or dropped. If the power cord is damaged, it must be replaced by General Electric Service or an authorized service agent using a power cord available from General Electric.
- Do not cover or block any openings on the appliance.
- Use this appliance only for its intended use as described in this manual. Do not use corrosive chemicals or vapors in this appliance. This microwave oven is specifically designed to heat, dry or cook food, and is not intended for laboratory or industrial use.
- To reduce the risk of fire in the oven cavity:
 - Do not overcook food. Carefully attend appliance when paper, plastic or other combustible materials are placed inside the oven while cooking.
 - Remove wire twist-ties and metal handles from paper or plastic containers before placing them in the oven.
 - Do not use the oven for storage purposes. Do not leave paper products, cooking utensils or food in the oven when not in use.
 - Do not pop popcorn in your microwave oven unless in a special microwave popcorn accessory or unless you use popcorn labeled for use in microwave ovens.
 - If materials inside the oven ignite, keep the oven door closed, turn the oven off and disconnect the power cord, or shut off power at the fuse or circuit breaker panel. If the door is opened, the fire may spread.
 - Do not use the Sensor Features twice in succession on the same food portion. If food is undercooked after the first countdown, use **Time Cook** for additional cooking time.

SAVE THESE INSTRUCTIONS

IMPORTANT SAFETY INSTRUCTIONS.

- When using the **Bake**, **Roast** or **Fast Bake** functions, both the outside and inside of the oven will become hot. Always use hot pads to remove containers of food and accessories such as the oven shelf.
- **Thermometer**—Do not use regular cooking or oven thermometers when cooking by microwave or using the **Fast Bake** mode. The metal and mercury in these thermometers could cause **arcing** and possible damage to the oven. Do not use a thermometer in food you are microwaving unless the thermometer is designed or recommended for use in the microwave oven.
- Do not clean with metal scouring pads. Pieces can burn off the pad and touch electrical parts involving risk of electric shock.
- Do not store any materials, other than our recommended accessories, in this oven when not in use.
- Do not store this appliance outdoors. Do not use this product near water—for example, in a wet basement, near a swimming pool, near a sink or in similar locations.
- Keep power cord away from heated surfaces.
- Do not immerse power cord or plug in water.
- Do not mount this appliance over a sink.
- See door surface cleaning instructions in the *Care and cleaning of the microwave oven* section of this manual.
- This appliance must only be serviced by qualified service personnel. Contact nearest authorized service facility for examination, repair or adjustment.
- As with any appliance, close supervision is necessary when used by children.
- Do not store anything directly on top of the microwave oven surface when the microwave oven is in operation.

SAVE THESE INSTRUCTIONS

⚠ WARNING!



ARCING

If you see arcing, press the **CLEAR/OFF** button and correct the problem.

Arcing is the microwave term for sparks in the oven. Arcing is caused by:

- The metal shelf not installed correctly so it touches the microwave wall.
- Metal or foil touching the side of the oven.
- Turntable ring support not installed correctly.
- Foil not molded to food (upturned edges act like antennas).
- Metal, such as twist-ties, poultry pins, or gold-rimmed dishes, in the microwave.
- Recycled paper towels containing small metal pieces being used in the microwave.

IMPORTANT SAFETY INSTRUCTIONS. READ ALL INSTRUCTIONS BEFORE USING.

⚠ WARNING!



FOODS

- Do not pop popcorn in your microwave oven unless in a special microwave popcorn accessory or unless you use popcorn labeled for use in microwave ovens.
- Do not boil eggs in a microwave oven. Pressure will build up inside egg yolk and will cause it to burst, possibly resulting in injury.
- Operating the microwave with no food inside for more than a minute or two may cause damage to the oven and could start a fire. It increases the heat around the magnetron and can shorten the life of the oven.
- Foods with unbroken outer “skin” such as potatoes, hot dogs, sausages, tomatoes, apples, chicken livers and other giblets, and egg yolks should be pierced to allow steam to escape during cooking.
- Some products such as whole eggs and sealed containers—for example, closed jars—are able to explode and should not be heated in this microwave oven. Such use of the microwave oven could result in injury.
- **SUPERHEATED WATER**
Liquids, such as water, coffee, or tea, are able to be overheated beyond the boiling point without appearing to be boiling. Visible bubbling or boiling when the container is removed from the microwave oven is not always present. THIS COULD RESULT IN VERY HOT LIQUIDS SUDDENLY BOILING OVER WHEN THE CONTAINER IS DISTURBED OR A SPOON OR OTHER UTENSIL IS INSERTED INTO THE LIQUID.
- Foods cooked in liquids (such as pasta) may tend to boil more rapidly than foods containing less moisture. Should this occur, refer to the *Care and cleaning of the microwave oven* section for instructions on how to clean the inside of the oven.
- Avoid heating baby food in glass jars, even with the lid off. Make sure all infant food is thoroughly cooked. Stir food to distribute the heat evenly. Be careful to prevent scalding when warming formula. The container may feel cooler than the formula really is. Always test the formula before feeding the baby.
- Don't defrost frozen beverages in narrow-necked bottles (especially carbonated beverages). Even if the container is opened, pressure can build up. This can cause the container to burst, possibly resulting in injury.
- Hot foods and steam can cause burns. Be careful when opening any containers of hot food, including popcorn bags, cooking pouches and boxes. To prevent possible injury, direct steam away from hands and face.
- Do not overcook potatoes. They could dehydrate and catch fire, causing damage to your oven.
- Cook meat and poultry thoroughly—meat to at least an INTERNAL temperature of 160°F and poultry to at least an INTERNAL temperature of 180°F. Cooking to these temperatures usually protects against foodborne illness.

To reduce the risk of injury to persons:

- Do not overheat the liquid.
- Stir the liquid both before and halfway through heating it.
- Do not use straight-sided containers with narrow necks.
- After heating, allow the container to stand in the microwave oven for a short time before removing the container.
- Use extreme care when inserting a spoon or other utensil into the container.

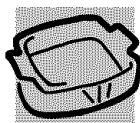

MICROWAVE-SAFE COOKWARE

Do not operate the oven in the microwave mode without the turntable and the turntable support seated and in place. The turntable must be unrestricted so it can rotate.

Make sure all cookware used in your microwave oven is suitable for microwaving. Most glass casseroles, cooking dishes, measuring cups, custard cups, pottery or china dinnerware which does not have metallic trim or glaze with a metallic sheen can be used. Some cookware is labeled "suitable for microwaving."

- If you are not sure if a dish is microwave-safe, use this test: Place in the oven both the dish you are testing and a glass measuring cup filled with 1 cup of water—set the measuring cup either in or next to the dish. Microwave 30–45 seconds at high. If the dish heats, it should not be used for microwaving.
 - If the dish remains cool and only the water in the cup heats, then the dish is microwave-safe.
 - Oversized food or oversized metal cookware should not be used in a microwave/convection oven because they increase the risk of electric shock and could cause a fire.
 - Sometimes the oven floor, turntable and walls can become too hot to touch. Be careful touching the floor, turntable and walls during and after cooking.
 - If you use a meat thermometer while microwaving or using the **FAST BAKE** mode, make sure it is safe for use in microwave ovens.
 - Do not use recycled paper products. Recycled paper towels, napkins and waxed paper can contain metal flecks which may cause arcing or ignite. Paper products containing nylon or nylon filaments should be avoided, as they may also ignite.
 - Some styrofoam trays (like those that meat is packaged on) have a thin strip of metal embedded in the bottom. When microwaved, the metal can burn the floor of the oven or ignite a paper towel.
 - Use of the shelf accessory:
 - Remove the shelf from the oven when not in use.
 - Use pot holders when handling the shelf and cookware. They may be hot.
 - Be sure that the shelf is positioned properly inside the oven to prevent product damage.
 - Do not cover the shelf or any part of the oven with metal foil. This will cause overheating of the microwave/convection oven.
 - Do not use your microwave/convection oven to dry newspapers.
 - Not all plastic wrap is suitable for use in microwave ovens. Check the package for proper use.
 - Paper towels, waxed paper and plastic wrap can be used to cover dishes in order to retain moisture and prevent spattering while microwaving. Be sure to vent plastic wrap so steam can escape.
 - Do not use paper products when the microwave/convection oven is operated in the **BAKE, ROAST** or **FAST BAKE** mode.
 - Cookware may become hot because of heat transferred from the heated food. Pot holders may be needed to handle the cookware.
 - When microwaving "boilable" cooking pouches and tightly closed plastic bags, they should be slit, pierced or vented as directed by package. If they are not, plastic could burst during or immediately after cooking, possibly resulting in injury. Also, plastic storage containers should be at least partially uncovered because they form a tight seal. When cooking with containers tightly covered with plastic wrap, remove covering carefully and direct steam away from hands and face.
 - Use foil only as directed in this manual. TV dinners may be microwaved in foil trays less than 3/4" high; remove the top foil cover and return the tray to the box. When using foil in the microwave oven, keep the foil at least 1" away from the sides of the oven.
 - Plastic cookware—Plastic cookware designed for microwave cooking is very useful, but should be used carefully. Even microwave-safe plastic may not be as tolerant of overcooking conditions as are glass or ceramic materials and may soften or char if subjected to short periods of overcooking. In longer exposures to overcooking, the food and cookware could ignite.
- Follow these guidelines:*
- 1** Use microwave-safe plastics only and use them in strict compliance with the cookware manufacturer's recommendations.
 - 2** Do not microwave empty containers.
 - 3** Do not permit children to use plastic cookware without complete supervision.

IMPORTANT SAFETY INFORMATION. READ ALL INSTRUCTIONS BEFORE USING.

⚠ WARNING!

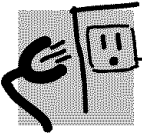

GROUNDING INSTRUCTIONS

WARNING: *Improper use of the grounding plug can result in a risk of electric shock.*

This appliance must be grounded. In the event of an electrical short circuit, grounding reduces the risk of electric shock by providing an escape wire for the electric current.

This appliance is equipped with a power cord having a grounding wire with a grounding plug. The plug must be plugged into an outlet that is properly installed and grounded.

Consult a qualified electrician or service technician if the grounding instructions are not completely understood, or if doubt exists as to whether the appliance is properly grounded.

If the outlet is a standard 2-prong wall outlet, it is your personal responsibility and obligation to have it replaced with a properly grounded 3-prong wall outlet.

Do not under any circumstances cut or remove the third (ground) prong from the power cord.

Do not use an adapter plug with this appliance.

Do not use an extension cord with this appliance. If the power cord is too short, have a qualified electrician or service technician install an outlet near the appliance.

For best operation, plug this appliance into its own electrical outlet to prevent flickering of lights, blowing of fuse or tripping of circuit breaker.

THE VENT FAN

The fan will operate automatically under certain conditions (see Automatic Fan feature). Take care to prevent the starting and spreading of accidental cooking fires while the vent fan is in use.

- Clean the underside of the microwave often. Do not allow grease to build up on the microwave or the fan filters.
- In the event of a grease fire on the surface units below the microwave oven, smother a flaming pan on the surface unit by covering the pan completely with a lid, a cookie sheet or a flat tray.

- Use care when cleaning the vent fan filters. Corrosive cleaning agents, such as lye-based oven cleaners, may damage the filters.
- When preparing flaming foods under the microwave, turn the fan on.
- Never leave surface units beneath your microwave oven unattended at high heat settings. Boilovers cause smoking and greasy spillovers that may ignite and spread if the microwave vent fan is operating. To minimize automatic fan operation, use adequate sized cookware and use high heat on surface units only when necessary.



READ AND FOLLOW THIS SAFETY INFORMATION CAREFULLY.

SAVE THESE INSTRUCTIONS

Available at extra cost from your GE supplier.

Filler Panel Kits

- **JX40WH—White**
- **JX41—Black**

When replacing a 36" range hood, filler panel kits fill in the additional width to provide a custom built-in appearance.

For installation between cabinets only; not for end-of-cabinet installation. Each kit contains two 3" wide filler panels.

Filter Kits

- **JX81D—Recirculating Charcoal Filter Kit**

Filter kits are used when the oven cannot be vented to the outside.

Safety Instructions

Operating Instructions

Care and Cleaning

Troubleshooting Tips

Consumer Support

About the features of your oven.

Throughout this manual, features and appearance may vary from your model.

1000 Watts

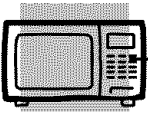
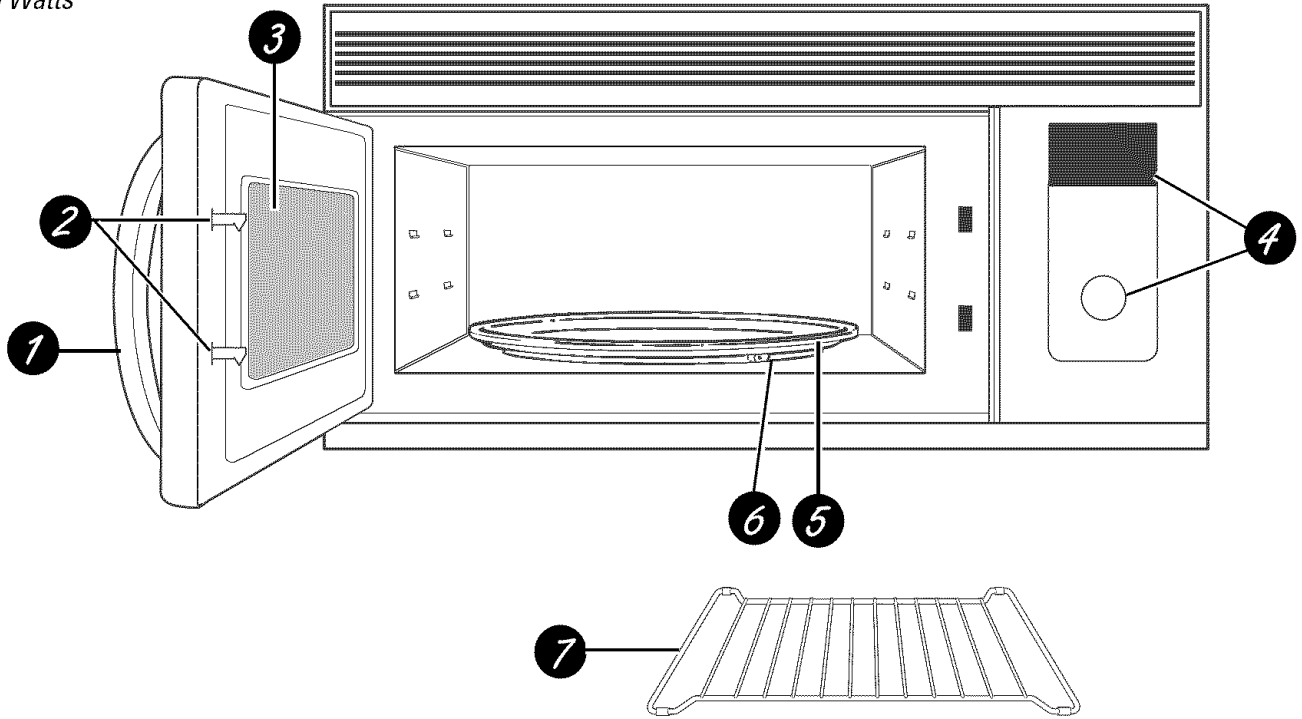

Features of the Oven

- 1 Door Latch Release Handle.**
- 2 Door Latches.**
- 3 Window with Metal Shield.** Screen allows cooking to be viewed while keeping microwaves confined in the oven.
- 4 Control Panel and Selector Dial.**
- 5 Removable Turntable.** Do not operate the oven in the microwave mode without the turntable and turntable support seated and in place.
- 6 Removable Turntable Support.** Do not operate the oven in the microwave mode without the turntable and turntable support seated and in place.
- 7 Shelves.** Use with **CONVECTION BAKE**, **CONVECTION ROAST** or **COMBINATION FAST BAKE**. (Do not use when microwave cooking.)

For best results, use one shelf in the lower position and leave at least a 1-inch gap between the cooking dish and the sides of the oven. For two-level Baking or Fast Baking use both shelves.

About the cooking and warming features of your microwave/convection oven.

ge.com

You can cook by Microwave, Convection Bake, Convection Roast or Combination Fast Bake. Keep hot, cooked foods at serving temperature with the Warm feature.

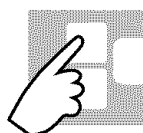
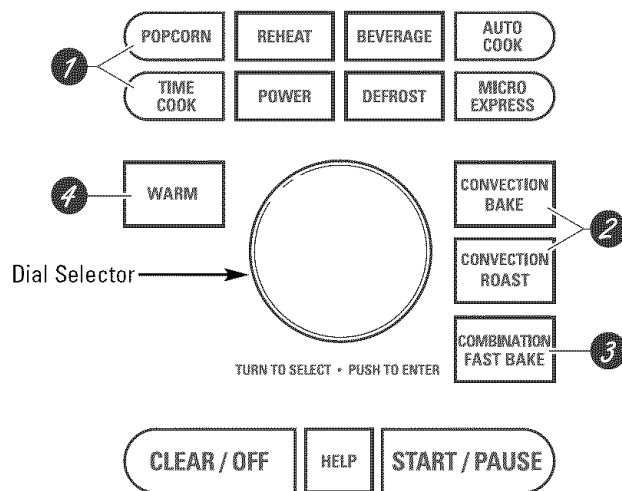

Cooking Controls

1 Microwave Cooking Time and Auto Features

Press *Turn and push dial to enter*

TIME COOK Amount of cooking time

Press once (Time Cook I) to microwave any time between 15 seconds and 95 minutes.

Press twice (Time Cook II) to change power levels automatically during cooking.

MICRO EXPRESS cook/Add 30 sec. Starts immediately!

DEFROST

Press once (Fast) Food weight up to one pound
 Press twice (Auto) Food weight up to six pounds
 Press three times (Time) Amount of defrosting time

BEVERAGE Starts immediately!

Press once (6–7 oz.)
 Press twice (8–9 oz.)
 Press three times (10–12 oz.)

POWER level Power level 1–10

Sensor Features

Press *Turn and push dial to enter* *Option*

POPCORN Starts immediately! more/less time

REHEAT Starts immediately! more/less time

Press once (plate)
 Press twice (pasta)
 Press three times (½ to 1 cup)
 Press four times (1 to 2 cups)

AUTO COOK Food type more/less time

2 Convection Baking or Convection Roasting

Press *Turn and push dial to enter*

CONVECTION BAKE or CONVECTION ROAST Oven temperature and cook time

3 Combination Fast Baking

Press *Turn and push dial to enter*

COMBINATION FAST BAKE Oven temperature and cook time

4 Warming

Press *Turn and push dial to enter*

WARM Oven temperature and warm time

Available cooking options.

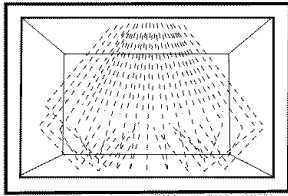

Microwave Cooking

Your oven uses microwave energy to cook by a set time or weight, or automatically by sensor.

Sensor microwave works by detecting the increasing humidity released during cooking. The oven automatically adjusts the cooking time to various types and amounts of food.

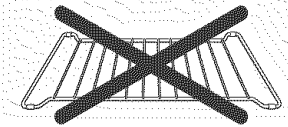

Do not use the shelves when microwave cooking.

Cooking Method

Microwave energy is distributed evenly throughout the oven for thorough, fast cooking of food.

Heat Source

Microwave energy.

Heat Conduction

Heat produced within food by instant energy penetration.

Benefits

Fast, high efficiency cooking. Oven and surroundings do not get hot. Easy clean-up.

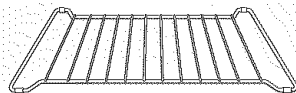
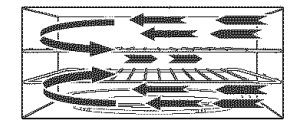
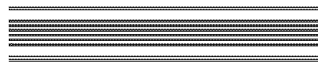

Always use the shelf when baking. For best results, use one shelf in the lower position. For two-level cooking only, use both shelves.

Convection Baking and Convection Roasting

During baking or roasting, a heating element is used to raise the temperature of the air inside the oven. Any oven temperature from 225°F. to 450°F. may be programmed. A fan gently circulates this heated air throughout the oven, over and around the food, producing golden brown exteriors and rich moist interiors. This circulation of heated air is called convection.

Because the heated air is kept constantly moving, not permitting a layer of cooler air to develop around the food, some foods cook faster than in regular oven cooking.

Cooking Method

Hot air circulates around food to produce browned exteriors and seal in juices.

Heat Source

Circulating heated air (Convection).

Heat Conduction

Heat conducted from outside of food to inside.

Benefits

Aids in browning and seals in flavor. Cooks some foods faster than regular ovens.

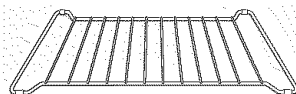
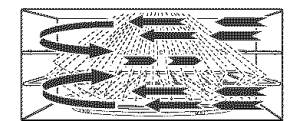

Always use the shelf with Fast Bake. For best results, use one shelf in the lower position. For two-level cooking only, use both shelves.

Combination Fast Baking

Your oven also offers the option of **Combination Fast Bake**, using microwave energy along with convection cooking. You cook with speed and accuracy, while browning and crisping to perfection.

Cooking Method

Microwave energy and convection heat combine to cook foods up to 25% faster than regular ovens, while browning and sealing in juices.

Heat Source

Microwave energy and circulating heated air.

Heat Conduction

Food heats from instant energy from penetration and heat conducted from outside of food.

Benefits

Shortened cooking time from microwave energy, plus browning and crisping from convection heat.

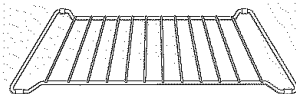
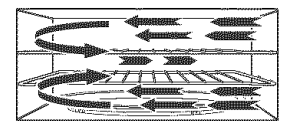

Always use the shelf when warming.

Warming

The warming feature will keep hot, cooked foods at serving temperature. Always start with hot food. Use cookware and utensils that can withstand temperatures up to 230°F.

Cooking Method

Warm air circulates around food to keep previously cooked food warm.

Heat Source

Circulating heated air (Convection).

Heat Conduction

Warmth conducted from outside of food to inside.

Benefits

Keeps hot, cooked foods at serving temperature.

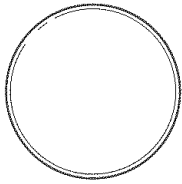

TURN TO SELECT • PUSH TO ENTER

Using the Dial

You can make selections on the oven by turning the dial and pressing it to enter the selection.

Pressing the dial can also be used in place of the **START/PAUSE** button for quicker programming of the oven.

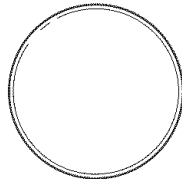

TURN TO SELECT • PUSH TO ENTER

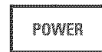

Time Cook (Do not use the shelves when microwave cooking.)

Time Cook I

Allows you to microwave for any time between 15 seconds and 95 minutes.

Power level 10 (High) is automatically set, but you may change it for more flexibility.

- 1 Press the **TIME COOK** button.
- 2 Turn the dial to set the cook time and press the dial to enter.
- 3 Change power level if you don't want full power. (Press **POWER**. Turn the dial to select. Press the dial to enter.)
- 4 Press the dial or the **START/PAUSE** button to start cooking.

You may open the door during **Time Cook** to check the food. Close the door and press the dial or **START/PAUSE** to resume cooking.

NOTE: You may change the cook time at any time during cooking by turning the dial. You may also change the power level by pressing the **POWER** button.

Time Cook II

Lets you change power levels automatically during cooking. Here's how to do it:

- 1 Press the **TIME COOK** button.
- 2 Turn the dial to set the first cook time and press the dial to enter.
- 3 Change the power level if you don't want full power. (Press **POWER**. Turn the dial to select. Press the dial to enter.)
- 4 Press the **TIME COOK** button again.
- 5 Turn the dial to set the second cook time and press the dial to enter.
- 6 Change the power level if you don't want full power. (Press **POWER**. Turn the dial to select. Press the dial to enter.)
- 7 Press the dial or the **START/PAUSE** button to start cooking.

At the end of **Time Cook I**, **Time Cook II** counts down.

NOTE: You may change the cook time at any time during cooking by turning the dial. You may also change the power level by pressing the **POWER** button.

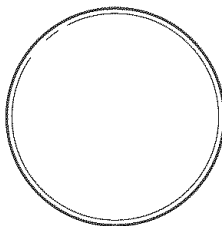

TURN TO SELECT • PUSH TO ENTER

Micro Express Cook (Do not use the shelves when microwave cooking.)

This is a quick way to set and start cooking in 30 second blocks each time the **MICRO EXPRESS** button is pressed. The cook time may be changed by turning the dial at any time during cooking.

The power level will automatically be set at 10 and the oven will start immediately.

The power level can be changed as time is counting down. Press the **POWER** button, turn the dial and press to enter.

About the time and auto microwave features.

DEFROST

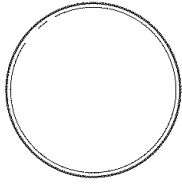

TURN TO SELECT • PUSH TO ENTER

START / PAUSE

Fast Defrost (Do not use the shelves when microwave cooking.)

Fast Defrost automatically sets the defrosting times and power levels to give even defrosting results for meats, poultry and fish weighing up to one pound.

■ Remove meat from package and place on microwave-safe dish.

- 1** Press the **DEFROST** button once.
- 2** Turn the dial to the food weight, using the Conversion Guide at right. For example, dial .5 for .5 pounds (8 oz.) Press the dial to enter.
- 3** Press the **START/PAUSE** button to start defrosting.
- 4** Turn the food over if the oven signals **TURN FOOD OVER**.

■ Remove defrosted meat or shield warm areas with small pieces of foil.

■ After defrosting, most meats need to stand 5 minutes to complete defrosting.

Conversion Guide

If the weight of food is stated in pounds and ounces, the ounces must be converted to tenths (.1) of a pound.

Weight of Food in Ounces	Enter Food Weight (tenths of a pound)
1-2	.1
3	.2
4-5	.3
6-7	.4
8	.5
9-10	.6
11	.7
12-13	.8
14-15	.9

DEFROST

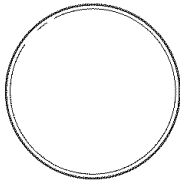

TURN TO SELECT • PUSH TO ENTER

START / PAUSE

Auto Defrost (Do not use the shelves when microwave cooking.)

Use **Auto Defrost** for meat, poultry and fish weighing up to six pounds. Use **Time Defrost** for most other frozen foods.

Auto Defrost automatically sets the defrosting times and power levels to give even defrosting results for meats, poultry and fish.

■ Remove meat from package and place on microwave-safe dish.

- 1** Press the **DEFROST** button twice.
- 2** Turn the dial to the food weight, using the Conversion Guide at right. For example, dial 1.2 for 1.2 pounds (1 pound, 3 oz.) Press the dial to enter.
- 3** Press the **START/PAUSE** button to start defrosting.
- 4** Turn the food over if the oven signals **TURN FOOD OVER**.

■ Remove defrosted meat or shield warm areas with small pieces of foil.

■ After defrosting, most meats need to stand 5 minutes to complete defrosting. Large roasts should stand for about 30 minutes.

Conversion Guide

If the weight of food is stated in pounds and ounces, the ounces must be converted to tenths (.1) of a pound.

Weight of Food in Ounces	Enter Food Weight (tenths of a pound)
1-2	.1
3	.2
4-5	.3
6-7	.4
8	.5
9-10	.6
11	.7
12-13	.8
14-15	.9

DEFROST

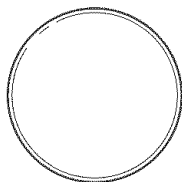

TURN TO SELECT • PUSH TO ENTER

START / PAUSE

Time Defrost (Do not use the shelves when microwave cooking.)

Use **Time Defrost** to defrost for a selected length of time.

- 1** Press the **DEFROST** button three times.
- 2** Turn the dial to select the time you want. Press the dial to enter.
- 3** Press the **START/PAUSE** button to start defrosting.
- 4** Turn the food over if the oven signals **TURN FOOD OVER**.

You may change the defrost time at any time during defrosting by turning the dial.

Power level is automatically set at 3, but can be changed. You can defrost small items quickly by raising the power level after entering the time. **Power level 7** cuts the total defrosting time in about half; **power level 10** cuts the total time to approximately 1/3. However, food will need more frequent attention than usual.

A dull thumping noise may be heard during defrosting. This is normal when oven is not operating at **High** power.

Defrosting Tips

- Foods frozen in paper or plastic can be defrosted in the package. Closed packages should be slit, pierced or vented **AFTER** food has partially defrosted. Plastic storage containers should be partially uncovered.
- Family-size, prepackaged frozen dinners can be defrosted and microwaved. If the food is in a foil container, transfer it to a microwave-safe dish.
- Foods that spoil easily should not be allowed to sit out for more than one hour after defrosting. Room temperature promotes the growth of harmful bacteria.
- For more even defrosting of larger foods, such as roasts, use **Auto Defrost**. Be sure large meats are completely defrosted before cooking.
- When defrosted, food should be cool but softened in all areas. If still slightly icy, return to the microwave very briefly, or let it stand a few minutes.

BEVERAGE

Beverage (Do not use the shelves when microwave cooking.)

The **BEVERAGE** feature heats beverages from 6 to 12 ounces.

Press once for 6–7 oz.

Press twice for 8–9 oz.

Press three times for 10–12 oz.

*Drinks heated with the **Beverage** feature may be very hot. Remove the container with care.*

About changing the power level.

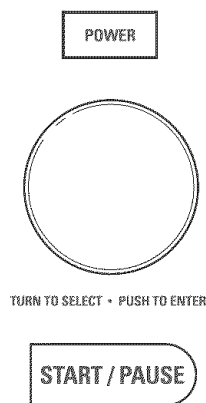

The power level may be entered or changed immediately after entering the time for **Time Cook**, **Time Defrost** or **Express Cook**. The power level may also be changed during time countdown.

- 1** First, follow directions for **Time Cook**, **Time Defrost** or **Express Cook**.
- 2** Press the **POWER** button.
- 3** Turn the dial clockwise to increase and counterclockwise to decrease the power level. Press the dial to enter.
- 4** Press the **START/PAUSE** button to start cooking.

Variable power levels add flexibility to microwave cooking. The power levels on the microwave oven can be compared to the surface units on a range. Each power level gives you microwave energy a certain percent of the time. **Power level 7** is microwave energy 70% of the time. **Power level 3** is energy 30% of the time. Most cooking will be done on **High (power level 10)** which gives you 100% power. **Power level 10** will cook faster but food may need more frequent stirring, rotating or turning over.

A lower setting will cook more evenly and need less stirring or rotating of the food. Some foods may have better flavor, texture or appearance if one of the lower settings is used. Use a lower power level when cooking foods that have a tendency to boil over, such as scalloped potatoes.

Rest periods (when the microwave energy cycles off) give time for the food to “equalize” or transfer heat to the inside of the food. An example of this is shown with **power level 3**—the defrost cycle. If microwave energy did not cycle off, the outside of the food would cook before the inside was defrosted.

Here are some examples of uses for various power levels:

High 10: Fish, bacon, vegetables, heating liquids.

Med-High 7: Gentle cooking of meat and poultry; baking casseroles and reheating.

Medium 5: Slow cooking and tenderizing for stews and less tender cuts of meat.

Low 2 or 3: Defrosting; simmering; delicate sauces.

Warm 1: Keeping food warm; softening butter.

Microwave terms.

Term	Definition
Arcing	Arcing is the microwave term for sparks in the oven. Arcing is caused by: <ul style="list-style-type: none"> ■ the metal shelf being installed incorrectly and touching the microwave walls. ■ metal or foil touching the side of the oven. ■ foil that is not molded to food (upturned edges act like antennas). ■ metal such as twist-ties, poultry pins, gold-rimmed dishes. ■ recycled paper towels containing small metal pieces. ■ the turntable ring support being installed incorrectly.
Covering	Covers hold in moisture, allow for more even heating and reduce cooking time. Venting plastic wrap or covering with wax paper allows excess steam to escape.
Shielding	In a regular oven, you shield chicken breasts or baked foods to prevent over-browning. When microwaving, you use small strips of foil to shield thin parts, such as the tips of wings and legs on poultry, which would cook before larger parts.
Standing Time	When you cook with regular ovens, foods such as roasts or cakes are allowed to stand to finish cooking or to set. Standing time is especially important in microwave cooking. Note that a microwaved cake is not placed on a cooling rack.
Venting	After covering a dish with plastic wrap, you vent the plastic wrap by turning back one corner so excess steam can escape.

Humidity Sensor

What happens when using the Sensor Features:

The Sensor Features detect the increasing humidity released during cooking. The oven automatically adjusts the cooking time to various types and amounts of food.

Do not use the Sensor Features twice in succession on the same food portion—it may result in severely overcooked or burnt food. If food is undercooked after the countdown, use **Time Cook** for additional cooking time.

NOTE: Sensor features will not operate when the oven is hot. If one of the sensor cooking buttons is pressed when the temperature inside the oven is greater than 200°F, "OVEN TOO HOT FOR SENSOR COOKING---USING ALTERNATE METHOD" will be displayed. The oven will automatically change to cook by time (follow the directions in the display) or once the oven is cool enough, the sensor features will function normally.

■ The proper containers and covers are essential for best sensor cooking.

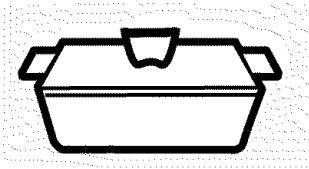

Covered

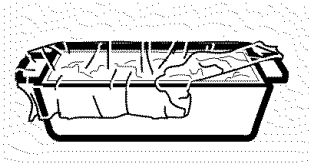

Vented

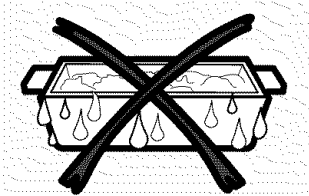

Dry off dishes so they don't mislead the sensor.

■ Always use microwave-safe containers and cover them with lids or vented plastic wrap. Never use tight sealing plastic containers—they can prevent steam from escaping and cause food to overcook.

■ Be sure the outside of the cooking containers and the inside of the microwave oven are dry before placing food in the oven. Beads of moisture turning into steam can mislead the sensor.



Auto Cook (Do not use the shelves when microwave cooking.)

Because most cooking containers must be covered during **Auto Cook**, this feature is best with foods that you want to steam or retain moisture.

NOTE: Use of the metal shelf with **Auto Cook** is not recommended.

Recommended Foods

A wide variety of foods including meats, fish and vegetables can be cooked using this feature.

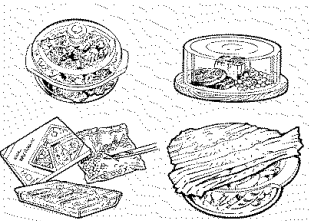

Foods not recommended

Foods that must be cooked uncovered, foods that require constant attention, foods that require addition of ingredients during cooking and foods calling for a dry look or crisp surface after cooking should not be cooked using this feature. It is best to **Time Cook** them.

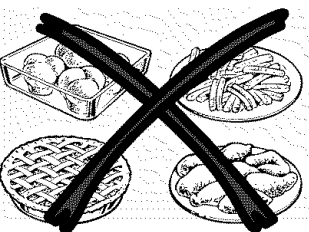

About the sensor microwave features.

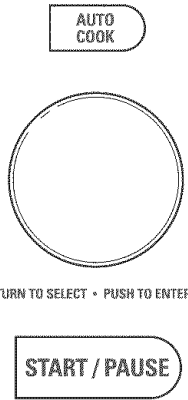

NOTE: Do not use this feature twice in succession on the same food portion—it may result in severely overcooked or burnt food.

Auto Cook (Do not use the shelves when microwave cooking.)

- 1** Place covered food in the oven and close the door. Press the **AUTO COOK** button. **ENTER FOOD TYPE** appears in the display.
- 2** Turn the dial to the desired food type. Press to enter.

See the *Sensor Food Type Guide* below for specific foods and instructions.

The oven starts immediately.

NOTE: If the door was open while the control was being set, close the door and press the **START/PAUSE** button to begin cooking.

If food is undercooked after the countdown, use **Time Cook** for additional cooking time.

*Do not open the oven door before the countdown time is displayed—steam escaping from the oven can affect cooking performance. If the door is opened, close the door and press **START/PAUSE** immediately.*

If ground meat was selected, the oven may signal you to drain and stir the meat. Open the door, drain the meat and close the door. Press the **START/PAUSE** button if necessary to resume cooking.

Cooking Tips

- When oven signals and countdown time is displayed, the door may be opened for stirring, turning or rotating food. To resume cooking, close the door and press **START/PAUSE**.
- Match the amount of food to the size of container. Fill containers at least 1/2 full.
- Be sure outside of container and inside of oven are dry.
- After completion of Cook cycle, if food needs additional cooking, return food to oven and use **Time Cook** to finish cooking.

How to Adjust the Oven's Automatic Settings for a Shorter or Longer Cook Time (Not available for all food types)

To subtract 10% from the automatic cooking time:

Within the first 30 seconds after the oven starts, turn the dial counterclockwise, until a minus ("–") sign appears, and press to enter.

To add 10% to the automatic cooking time:

Within the first 30 seconds after the oven starts, turn the dial clockwise, until a plus ("+") sign appears, and press to enter.

Sensor Food Type Guide

Food Type	Servings	Serving Size	Comments
Chicken Pieces	1 to 4	2 to 8 pieces	Use oblong, square or round dish. Cover with vented plastic wrap.
Fish	1 to 4	4 to 16 oz.	Use oblong, square or round dish. Cover with vented plastic wrap.
Ground Meat (Beef, Pork, Turkey)	—	8 to 32 oz.	Use round casserole dish. Crumble meat into dish. Cover with vented plastic wrap.
Potatoes	1 to 4	8 to 32 oz.	Pierce skin with fork. Arrange in a star pattern in center of turntable.
Canned Vegetables	1 to 4	4 to 16 oz.	Use microwave-safe casserole or bowl. Cover with lid or vented plastic wrap.
Fresh Vegetables	1 to 4	4 to 16 oz.	Use microwave-safe casserole or bowl. Add 2 tablespoons water for each serving. Cover with lid or vented plastic wrap.
Frozen Vegetables	1 to 4	4 to 16 oz.	Use microwave-safe casserole or bowl. Follow package instructions for adding water. Cover with lid or vented plastic wrap.

POPCORN

Use only with prepackaged microwave popcorn weighing 1.5 to 3.5 ounces.

NOTE: Do not use this feature twice in succession on the same food portion—it may result in severely overcooked or burnt food.

Popcorn (Do not use the shelves when microwave cooking.)

To use the **Popcorn** feature:

- 1** Follow package instructions, using **Time Cook** if the package is less than 1.5 ounces or larger than 3.5 ounces. Place the package of popcorn in the center of the turntable.
- 2** Press the **POPCORN** button. The oven starts immediately.

If you open the door while **POPCORN SENSOR** is displayed, an error message will appear. Close the door, press **CLEAR/OFF** and begin again.

If food is undercooked after the countdown, use **Time Cook** for additional cooking time.

How to Adjust the Automatic Popcorn Setting to Provide a Shorter or Longer Cook Time

If you find that the brand of popcorn you use underpops or overpops consistently, you can add or subtract 20–30 seconds to the automatic popping time.

To subtract time:

Within the first 30 seconds after the oven starts, turn the dial counterclockwise, until a minus (“-”) sign appears, for 20 seconds less cooking time. Press to enter. Turn again, until two minus (“--”) signs appear, to reduce cooking time another 10 seconds for a total of 30 seconds less time. Press to enter.

To add time:

Within the first 30 seconds after the oven starts, turn the dial clockwise, until a plus (“+”) sign appears, for an extra 20 seconds cooking time. Press to enter. Turn again, until two plus (“++”) signs appear, to add another 10 seconds for a total of 30 seconds additional time. Press to enter.

REHEAT

NOTE: Do not use this feature twice in succession on the same food portion—it may result in severely overcooked or burnt food.

Reheat (Do not use the shelves when microwave cooking.)

The **Reheat** feature reheats servings of previously cooked foods or a plate of leftovers.

- 1** Place the cup of liquid or covered food in the oven. Press **REHEAT** once, twice, three times or four times. The oven starts immediately.
Press once for a plate of leftovers.
Press twice for a pasta.
Press three times for 1/2 to 1 full cup.
Press four times for 1 to 2 full cups.
- 2** The oven signals when steam is sensed and the time remaining begins counting down.

Do not open the oven door until time is counting down. If the door is opened, close it and press **START** immediately.

After removing food from the oven, stir, if possible, to even out the temperature. Reheated foods may have wide variations in temperature. Some areas of food may be extremely hot.

If food is not hot enough after the countdown use **Time Cook** for additional reheating time.

Some Foods Not Recommended for Use With Reheat

It is best to use **Time Cook** for these foods:

- Bread products.
- Foods that must be reheated uncovered.
- Foods that need to be stirred or rotated.
- Foods calling for a dry look or crisp surface after reheating.

How to Adjust the Oven's Automatic Settings for a Shorter or Longer Time

To subtract 10% from the automatic cooking time:

Within the first 30 seconds after the oven starts, turn the dial counterclockwise, until a minus (“-”) sign appears, and press to enter.

To add 10% to the automatic cooking time:

Within the first 30 seconds after the oven starts, turn the dial clockwise, until a plus (“+”) sign appears, and press to enter.

About the baking and roasting features.

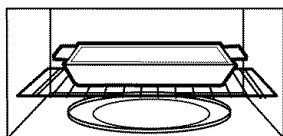

Correct shelf position

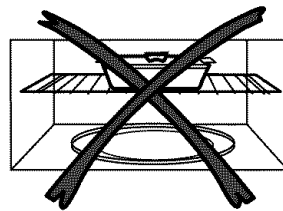

Incorrect shelf position

Baking or roasting uses a heating element to raise the temperature of the air inside the oven. Any oven temperature from 225°F to 450°F may be set. A fan gently circulates this heated air throughout the oven, over and around the food, producing golden brown exteriors and rich, moist interiors. This circulation of heated air is called convection.

Because the heated air is kept constantly moving, not permitting a layer of cooler air to develop around the food, some foods cook faster than in regular oven cooking.

For Best Results...

Use one shelf in the lower position and leave at least a 1-inch gap between the cooking dish and the sides of the oven. For two-level cooking only, use both shelves.

The shelf is required for good air circulation and even browning.

See the *Cookware Tips* section for information on suggested cookware.

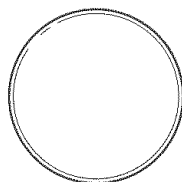

TURN TO SELECT • PUSH TO ENTER

Bake or Roast with Preheat

- 1 Press the **BAKE** or **ROAST** button.
- 2 Turn the dial to set the oven temperature and press dial to enter.
Do not enter bake time now. (The cook time will be entered later, after the oven is preheated.) See the *Auto Recipe™ Conversion* section below.
- 3 Press the dial or the **START/PAUSE** button to start preheating.
- 4 When the oven is preheated, it will signal. If you do not open the door within 1 hour, the oven will turn off automatically.
- 5 Open the oven door and, using caution, place the food in the oven.

- 6 Close the oven door. Turn the dial to set the cook time and press the dial or **START/PAUSE** to start cooking.
- 7 When cooking is complete, the oven will signal and turn off.

NOTE: You may change the cook time at any time during cooking by turning the dial.

You may change the oven temperature at any time during cooking by pressing the **POWER** button. Turn the dial to set the oven temperature and press the dial to enter.

To view the cook time and oven temperature during cooking, press the **BAKE** button.

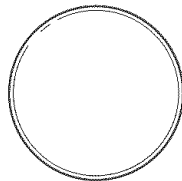

TURN TO SELECT • PUSH TO ENTER

Bake or Roast without Preheating

- 1 If your recipe does not require preheating, press the **BAKE** or **ROAST** button. See the *Auto Recipe™ Conversion* section below.
- 2 Turn the dial to set the oven temperature and press to enter.
- 3 Turn the dial to set the cook time and press to enter.
- 4 Press the dial or the **START/PAUSE** button to start the oven.

NOTE: You may change the cook time at any time during cooking by turning the dial.

You may change the oven temperature at any time during cooking by pressing the **POWER** button. Turn the dial to set the oven temperature and press the dial to enter.

To view the cook time and oven temperature during cooking, press the **BAKE** button.

Auto Recipe™ Conversion

When using **CONVECTION BAKE**, the **Auto Recipe™ Conversion** feature will automatically convert entered regular baking temperatures to convection baking temperatures.

This feature is activated so that the display will show **OFFSET ON** and the actual converted (reduced) temperature. For example, if you enter a regular recipe temperature of 350°F and press the **START** button, the display will show the converted temperature of 325°F.

This feature can be turned off in the **OPTIONS** menu. See the *Auto Recipe™ Conversion Selection* in the *About the other features* section.

NOTE: If convection baking and the **Auto Recipe™ Conversion** feature is turned off, reduce the oven temperature 25°F from the recipe to prevent overbrowning on the top of baked goods

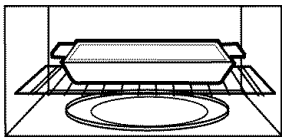

Correct shelf position

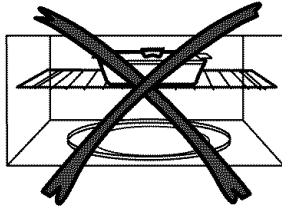

Incorrect shelf position

Fast Bake offers the best features of microwave energy and convection cooking. Microwaves cook food fast and convection circulation of heated air browns foods beautifully. Any oven temperature from 225°F to 450°F may be set.

For Best Results...

Use one shelf in the lower position and leave at least a 1-inch gap between the cooking dish and the sides of the oven. For two-level cooking only, use both shelves.

The shelf is required for good air circulation and even browning.

See the *Cookware Tips* section for information on suggested cookware.

See the *Best Method of Cooking* section to determine the which foods are appropriate to cook using **Fast Bake**.

COMBINATION
FAST BAKE

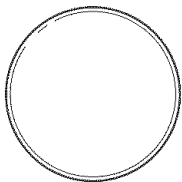

TURN TO SELECT • PUSH TO ENTER

START / PAUSE

Fast Bake with Preheat

- 1 Press the **FAST BAKE** button.
- 2 Turn the dial to set the oven temperature and press dial to enter. Do not enter **FAST BAKE** cook time now. (The cook time will be entered later, after the oven is preheated.)
- 3 Press the dial or the **START/PAUSE** button to start preheating.
- 4 When the oven is preheated, it will signal. If you do not open the door within 1 hour, the oven will turn off automatically.
- 5 Open the oven door and, using caution, place the food in the oven.
- 6 Close the oven door. Turn the dial to set the cook time and press to enter. Press the dial or the **START/PAUSE** button to start cooking.
- 7 When cooking is complete, the oven will signal and turn off.

NOTE: You may change the cook time at any time during cooking by turning the dial.

You may change the oven temperature and microwave power level at any time during cooking by pressing the **POWER** button. Turn the dial to set the oven temperature and press the dial to enter. Then, turn the dial to set microwave power level 1 through 4 and press the dial to enter. The default power level is 4.

To view the cook time and oven temperature during cooking, press the **FAST BAKE** button.

- Check the *Cookware Tips* section for correct cookware when using **Fast Bake**.
- Do not use metal cookware with **Fast Bake**.
- Reduce the recipe cook time by 25%.
- See the *Best Method of Cooking* section to determine the which foods are appropriate to cook using **Fast Bake**.

Fast Bake without Preheat

- 1 If your recipe does not require preheating, press the **FAST BAKE** button.
- 2 Turn the dial to set the oven temperature and press to enter.
- 3 Turn the dial to set the cook time and press to enter.
- 4 Press the dial or the **START/PAUSE** button to start the oven.

NOTE: You may change the cook time at any time during cooking by turning the dial.

You may change the oven temperature and microwave power level at any time during cooking by pressing the **POWER** button. Turn the dial to set the oven temperature and press the dial to enter. Then, turn the dial to set microwave

power level 1 through 4 and press the dial to enter. The default power level is 4.

To view the cook time and oven temperature during cooking, press the **FAST BAKE** button.

NOTE:

- Some recipes call for preheating.
- Check the *Cookware Tips* section for correct cookware when using **Fast Bake**.
- Do not use metal cookware with **Fast Bake**.
- See the *Best Method of Cooking* section to determine the which foods are appropriate to cook using **Fast Bake**.
- Reduce the recipe cook time by 25%.

Cookware tips.

Convection Bake or Roast

Metal Pans are recommended for all types of baked products, but especially where browning is important.

Dark or dull finish metal pans are best for breads and pies because they absorb heat and produce crisper crust.

Shiny aluminum pans are better for cakes, cookies or muffins because they reflect heat and help produce a light tender crust.

Glass or Glass-Ceramic casserole or baking dishes are best suited for egg and cheese recipes due to the cleanability of glass.

Combination Fast Bake

Glass or Glass-Ceramic baking containers are recommended. Be sure not to use items with metal trim as it may cause arcing (sparking) with oven wall or oven shelf. This can damage the cookware, the shelf or the oven.

Heat-Resistant Plastic microwave cookware (safe to 450°F) may be used, but it is not recommended for foods requiring all-around browning, because the plastic is a poor conductor of heat.

Cookware	Microwave	Convection Bake or Roast	Combination Fast Bake
Heat-Resistant Glass, Glass-Ceramic (Pyrex®, Fire King®, Corning Ware®, etc.)	Yes	Yes	Yes
Metal	No	Yes	No
Non Heat-Resistant Glass	No	No	No
Microwave-Safe Plastics	Yes	No	Yes*
Plastic Films and Wraps	Yes	No	No
Paper Products	Yes	No	No
Straw, Wicker and Wood	Yes	No	No

* Use only microwave cookware that is safe to 450°F.

Select the best method of cooking.

Use the following guide to select the best method of cooking. Recipes can be adapted using the guidelines below to determine the appropriate cooking mode.

Foods	Microwave	Bake	Roast	Fast Bake
Appetizers				
Dips and Spreads	✓			
Pastry Snacks	✓	✓		✓
Beverages				
	✓			
Sauces and Toppings				
	✓			
Soups and Stews				
	✓			
Meats				
Defrosting	✓			
Roasting			✓	✓
Poultry				
Defrosting	✓			
Roasting	✓		✓	✓
Fish and Seafood				
Defrosting	✓			
Cooking	✓	✓		✓
Casseroles				
	✓	✓		✓
Eggs and Cheese				
Scrambled, Omelets	✓	✓		
Quiche, Souffle		✓		✓
Vegetables, (fresh)				
	✓			
Breads				
Muffins, Coffee Cake	✓	✓		
Quick		✓		
Yeast		✓		
Desserts				
Cakes, Layer and Bundt		✓		
Angel Food and Chiffon		✓		
Custard and Pudding	✓			
Bar Cookies	✓	✓		
Fruit	✓			
Pies and Pastry		✓		
Candy	✓			
Blanching Vegetables				
	✓			
Frozen Convenience Foods				
	✓	✓		✓

Recipe conversions.

Combination Fast Bake

When using **COMBINATION FAST BAKE**, reduce recipe cook time by 25%.

For Example: A recipe states to cook a roast for 60 minutes at 400°F.

60 minutes x 0.25 = 15 minutes saved

So the new cook time in **FAST BAKE** mode will be:

60 minutes – 15 minutes = **45 minutes.**

About the warming feature.

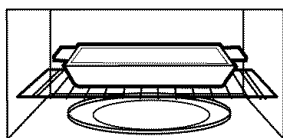

Correct shelf position

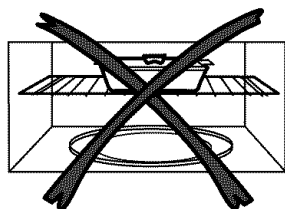

Incorrect shelf position

The **WARM** feature will keep hot, cooked foods at serving temperature. Always start with hot food. Use cookware and utensils that can withstand temperatures up to 230°F.

For Best Results...

Always use the shelf in its "low" position when warming. The shelf is required for good air circulation and even warming.

See the **Cookware Tips** section for information on suggested cookware.

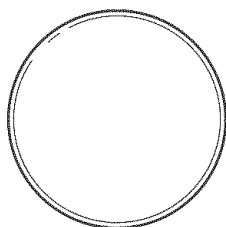

TURN TO SELECT • PUSH TO ENTER

- 1** Press the **WARM** button.
- 2** Turn the dial to select the oven temperature. See the chart and tips below. Press the dial to enter.

LOW	150°F
MEDIUM	170°F
HIGH	210°F

- 3** Press the dial or the **START/PAUSE** button to start warming.

If the oven door is opened during warming, **PAUSE** will appear in the display. Close the door and press **START/PAUSE**.

To Crisp Stale Items:

- Place food or dishes directly on the shelf in the low position.
- Use **LOW** setting.
- Check crispness after 45 minutes. Add time as needed.

Temperature Selection Chart

Food Type	Control Setting	Moist/Crisp
Bread, Hard Rolls	Medium	Crisp
Bread, Soft Rolls	Medium	Moist
Casseroles	Medium	Moist
Fried Foods	High	Crisp
Meats* and Fish	Medium	Crisp
Pancakes, Waffles	High	Crisp
Pizza	High	Crisp
Potatoes, Baked	High	Crisp
Potatoes, Mashed	Medium	Moist
Poultry	High	Moist
Tortilla Chips	Low	Crisp
Vegetables	Medium	Moist

* USDA/FSIS recommends an internal temperature of 145°F as the minimum doneness for beef. Use a portable meat thermometer to check internal temperatures.

Tips for Crisp Foods:

- Leave food uncovered.
- Do not use plastic containers or plastic wrap.

Tips for Moist Foods:

- Cover food with lid or aluminum foil.
- Do not use plastic containers or plastic wrap.

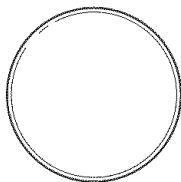

TURN TO SELECT • PUSH TO ENTER

Help

The **HELP** button displays feature information and helpful hints. Press **HELP**, then turn the dial to select a feature and press the dial to enter.

Cooking Complete Reminder

To remind you that you have food in the oven, the oven will display **YOUR FOOD IS READY** and beep once a minute until you

either open the oven door or press the **CLEAR/OFF** button.

Resume

The cooking program just used stays in memory for 5 minutes. After that you will need to begin the program again. To turn this option off, see the *More Time Message* section.

2 **RESUME COOKING** will be displayed and the oven will restart immediately at 10% of the original time.

1 If your food needs to cook a bit longer, you can restart the oven by pressing the **START/PAUSE** button or selector dial.

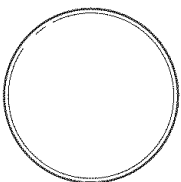

TURN TO SELECT • PUSH TO ENTER

Clock

Press to enter the time of day or to check the time of day while cooking.

1 Turn the dial to select AM or PM. Press the dial to enter.

- 1** Press the **CLOCK** button.
- 2** Turn the dial to set hours. Press the dial to enter.
- 3** Turn the dial to set minutes. Press the dial to enter.



Start/Pause

In addition to starting many functions, **START/PAUSE** allows you to stop cooking without opening the door or clearing the display.



Clear/Off

Press the **CLEAR/OFF** button to stop and cancel cooking at any time.



Child Lock-Out

You may lock the control panel to prevent the oven from being accidentally started or used by children.

To lock or unlock the controls, press and hold the **CLEAR/OFF** button for about three seconds. When the control panel is locked, **CONTROL LOCKED** will be displayed briefly anytime a button or dial is pressed.

About the other features.

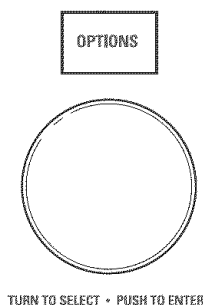

Auto Nite Light

The **Auto Nite Light** can be set to come on and go off at desired times.

- 1** Press the **OPTIONS** button and turn the dial to select **AUTO NITE LIGHT**. Press the dial to enter.
- 2** Turn the dial to select **SET TIMES**. Press the dial to enter.
- 3** Enter the time of day for the light to come on by turning the dial to select the hour, minutes and AM or PM. Press the dial to enter after each selection.

- 4** Enter the time of day for the light to go off by turning the dial to select the hour, minutes and AM or PM. Press the dial to enter after each selection.

NOTE: The NITE indicator will be lit whenever the nite light is set to operate.

To review the nite light settings, turn the dial to select **REVIEW SETTINGS** after selecting the **Auto Nite Light** option. Press the dial to enter.

To clear the nite light settings, turn the dial to select **CLEAR SETTINGS** after selecting the **Auto Nite Light** option. Press the dial to enter.

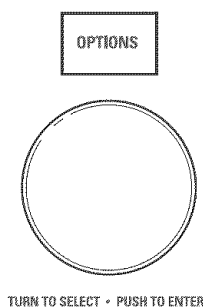

Bake Temp. Adjust

Use to set the oven to automatically adjust set temperatures by 5, 10, 15, 20 or 25 degrees.

- 1** Press the **OPTIONS** button and turn the dial to select **BAKE TEMP ADJUST**. Press the dial to enter.
- 2** Turn the dial to select **NO CHANGE**, 5, 10, 15, 20 or 25 degrees and press to enter.

Beeper Volume

The beeper sound level can be adjusted.

- 1** Press the **OPTIONS** button and turn the dial to select **BEEPER VOLUME**. Press the dial to enter.
- 2** Turn the dial to select mute to loud. Press the dial to enter.

NOTE: The MUTE indicator will be lit whenever the beeper volume is set to mute.

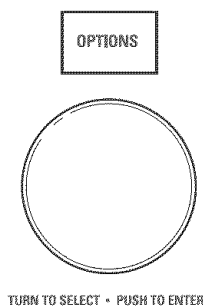

Auto Recipe™ Conversion Selection

When ON the oven will automatically convert entered regular baking temperatures to convection baking temperatures. See *Auto Recipe™ Conversion* in the *About the baking and roasting features* section.

- 1** Press the **OPTIONS** button and turn the dial to select **OFFSET**. Press the dial to enter.
- 2** Turn the dial to select **CONVECTION BAKE TEMP OFFSET-ON/OFF** and press to enter.

Display Language

The language for the scrolling display can be set to either English or Spanish.

- 1** Press the **OPTIONS** button and turn the dial to select **DISPLAY LANGUAGE**. Press the dial to enter.
- 2** Turn the dial to select **ENGLISH** or **SPANISH**. Press the dial to enter.

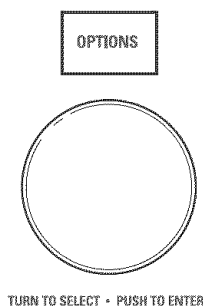

Display ON/OFF

Use to turn your clock display on or off.

- 1** Press the **OPTIONS** button and turn the dial to select **DISPLAY ON/ OFF**. Press the dial to enter.
- 2** Turn the dial to select **ON** or **OFF**. Press the dial to enter.

Display Speed

The scroll speed of the display can be changed.

- 1** Press the **OPTIONS** button and turn the dial to select **DISPLAY SPEED**. Press the dial to enter.
- 2** Turn the dial to select slowest to fastest. Press the dial to enter.

OPTIONS

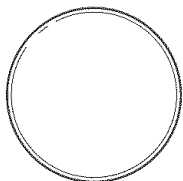

TURN TO SELECT • PUSH TO ENTER

Measures

Measurements can be set to display in Default (English) or metric.

- 1 Press the **OPTIONS** button and turn the dial to select **MEASURES**. Press the dial to enter.
- 2 Turn the dial to select **DEFAULT** or **METRIC** and press to enter.

More Time Message

After cooking is complete, a message can be displayed giving you the option to cook the food longer at the same settings. See the *Resume* section.

- 1 Press the **OPTIONS** button and turn the dial to select **MORE TIME MESSAGE**. Press the dial to enter.
- 2 Turn the dial to select **MESSAGE ON** or **OFF** and press to enter.

SURFACE LIGHT



Surface Light

Press **SURFACE LIGHT** once for bright light, twice for the night light or a third time to turn the light off.

TIMER

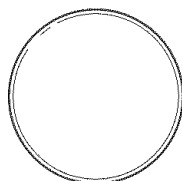

TURN TO SELECT • PUSH TO ENTER

Timer

The **Timer** operates as a minute timer and can be used at any time, even when the oven is operating.

- 1 Press the **TIMER** button.
- 2 Turn the dial to select the minutes. Press the dial to enter.
- 3 Turn the dial to select the seconds. Press the dial to enter.
- 4 Press the dial or **TIMER** to start.

To cancel, press the **TIMER** button.

When time is up, the oven will signal. To turn off the timer signal, press **TIMER**.

NOTE: The **TIMER** indicator will be lit while the timer is operating.

TURNTABLE ON / OFF

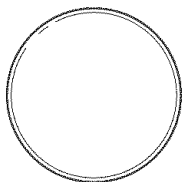

TURN TO SELECT • PUSH TO ENTER

Turntable On/Off

For best cooking results, leave the turntable on. It can be turned off for large dishes.

- 1 Press the **TURNTABLE ON/OFF** button.
- 2 Turn the dial to select **ON** or **OFF**. Press the dial to enter.

Sometimes the turntable can become too hot to touch.

Be careful touching the turntable during and after cooking.

VENT FAN



Vent Fan

The vent fan removes steam and other vapors from surface cooking.

Press **VENT FAN** once for high fan speed, twice for medium fan speed, three times for low fan speed or a fourth time to turn the fan off.

NOTE: The **FAN** indicator will be lit while the fan is operating.

Automatic Fan

An automatic fan feature protects the microwave from too much heat rising from the cooktop below it. It automatically turns on if it senses too much heat.

If you have turned the fan on you may find that you cannot turn it off. The fan will automatically turn off when the internal parts are cool. It may stay on for 30 minutes or more after the cooktop and microwave controls are turned off.

Care and cleaning of the oven.

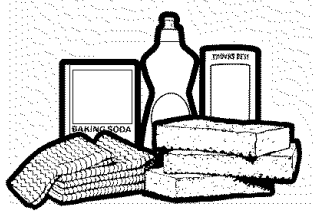

Helpful Hints

An occasional thorough wiping with a solution of baking soda and water keeps the inside fresh.

Be sure the power is off before cleaning any part of this oven.

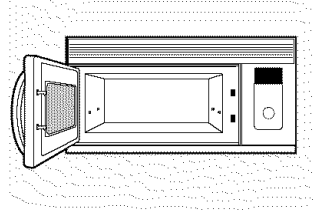

How to Clean the Inside

Walls, Floor, Inside Window, Metal and Plastic Parts on the Door

Some spatters can be removed with a paper towel; others may require a damp cloth. Remove greasy spatters with a sudsy cloth, then rinse with a damp cloth. Do not use abrasive cleaners or sharp utensils on oven walls.

Never use a commercial oven cleaner on any part of your microwave.

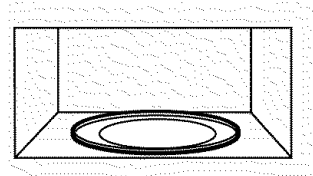

Removable Turntable and Turntable Support

To prevent breakage, do not place the turntable into water just after cooking. Wash it carefully in warm, sudsy water or in the dishwasher. The turntable and support can be broken if dropped. Remember, do not operate the oven in the microwave mode without the turntable and support seated and in place.

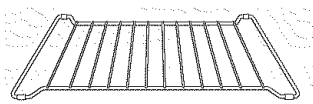

Shelves

Clean with mild soap and water or in the dishwasher.

Do not clean in a self-cleaning oven.

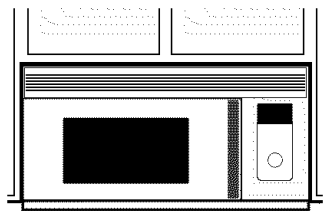

How to Clean the Outside

We recommend against using cleaners with ammonia or alcohol, as they can damage the appearance of the microwave oven. If you choose to use a common household cleaner, first apply the cleaner directly to a clean cloth, then wipe the soiled area.

Bottom

Clean off the grease and dust on the bottom often. Use a solution of warm water and detergent.

Case

Clean the outside of the microwave with a sudsy cloth. Rinse with a damp cloth and then dry. Wipe the window clean with a damp cloth.

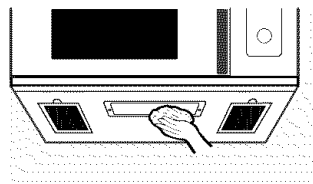

Control Panel and Door

Wipe with a damp cloth. Dry thoroughly. Do not use cleaning sprays, large amounts of soap and water, abrasives or sharp objects on the panel—they can damage it. Some paper towels can also scratch the control panel.

Door Surface

It is important to keep the area clean where the door seals against the microwave. Use only mild, non-abrasive detergents applied with a clean sponge or soft cloth. Rinse well.

Stainless Steel

Do not use a steel-wool pad; it will scratch the surface.

- 1 Shake bottle well.
- 2 Place a small amount of CERAMA BRYTE® Stainless Steel Appliance Cleaner on a **damp** cloth or **damp** paper towel.
- 3 Clean a small area (approximately 8" x 8"), rubbing with the grain of the stainless steel if applicable.
- 4 Dry and buff with a clean, dry paper towel or soft cloth.
- 5 Repeat as necessary.

NOTE: If a mineral oil-based stainless steel appliance cleaner has been used before to clean the appliance, wash the surface with dishwashing liquid and water prior to using

the CERAMA BRYTE® Stainless Steel Appliance Cleaner. After washing the surface with dishwashing liquid and water, use a generous amount of CERAMA BRYTE® Stainless Steel Appliance Cleaner to clean the appliance.

To Order

To order CERAMA BRYTE® Stainless Steel Appliance Cleaner, please call our toll-free number:

National Parts Center 800.626.2002
ge.com

CERAMA BRYTE®
Stainless Steel Appliance
Cleaner #PM10X311

Replacing the light bulb.

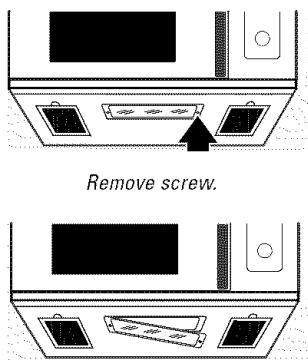

Cooktop Light/Nite Light

Replace with a 120 volt, 40 watt (max.) halogen bulb. Order WB08X10051 from your GE supplier.

- 1 To replace the cooktop light/ nite light, first disconnect the power at the main fuse or circuit breaker panel, or pull the plug.
- 2 Remove the screw from the side of the light compartment cover and lower the cover until it stops.
- 3 Be sure the bulb is cool before removing. Break the adhesive seal by gently unscrewing the bulb.
- 4 Screw in the new bulb, then raise the light cover and replace the screw. Connect electrical power to the oven.

About the exhaust feature.

Charcoal filter (on some models).

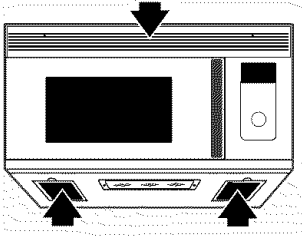

Reusable vent filters
(on all models).

Vent Fan

The vent fan has two metal reusable vent filters.

Models that recirculate air back into the room also use a charcoal filter.

Reusable Vent Filters

The metal filters trap grease released by foods on the cooktop. They also prevent flames from foods on the cooktop from damaging the inside of the oven.

For this reason, the filters must always be in place when the hood is used. The vent filters should be cleaned once a month, or as needed.

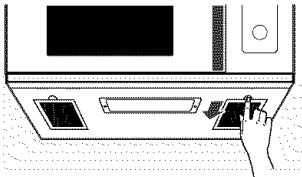

Removing and Cleaning the Filters

To remove, slide them to the rear using the tabs. Pull down and out.

To clean the vent filters, soak them and then swish around in hot water and detergent. Don't use ammonia or ammonia products because they will darken the metal. Light brushing can be used to remove embedded dirt.

Rinse, shake and let dry before replacing.

To replace, slide the filters into the frame slots on the back of each opening. Press up and to the front to lock into place.

Charcoal Filter

The charcoal filter cannot be cleaned. It must be replaced. Order Part No. WB02X10943 from your GE supplier.

If the model is not vented to the outside, the air will be recirculated through a disposable charcoal filter that helps remove smoke and odors.

The charcoal filter should be replaced when it is noticeably dirty or discolored (usually after 6 to 12 months, depending on usage).

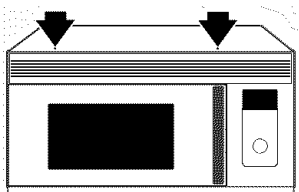

Remove 2 grille screws to remove the grille.

To Remove the Charcoal Filter

To remove the charcoal filter, first disconnect power at the main fuse or circuit breaker, or pull the plug. Remove the top grille by removing the two screws that hold it in place.

You may need to open the cabinet doors to remove the screws.

Lift the filter at the bottom until it comes free of the tabs. Slide the filter down and out.

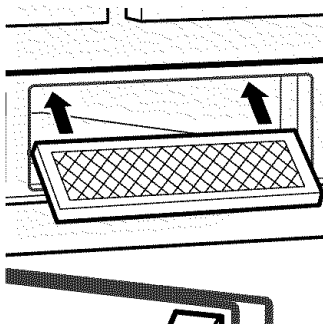
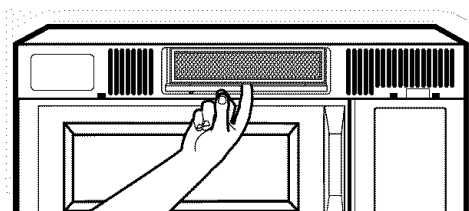

To Install the Charcoal Filter

To install a new charcoal filter, remove plastic and other outer wrapping from the new filter.

Insert the top of the filter up and into the grooves on the inside of the top opening. Push the bottom of the filter in until it rests in place behind the tabs.

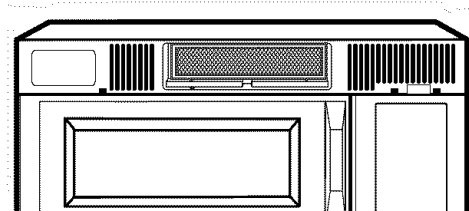

Before you call for service...



Troubleshooting Tips

Save time and money! Review the charts on the following pages first and you may not need to call for service.

Problem	Possible Causes	What To Do
Oven will not start	A fuse in your home may be blown or the circuit breaker tripped.	• Replace fuse or reset circuit breaker.
	Power surge.	• Unplug the microwave oven, then plug it back in.
	Plug not fully inserted into wall outlet.	• Make sure the 3-prong plug on the oven is fully inserted into wall outlet.
	Door not securely closed.	• Open the door and close securely.
Control panel lighted, yet oven will not start	Door not securely closed.	• Open the door and close securely.
	START/PAUSE button not pressed after entering cooking selection.	• Press START/PAUSE .
	Another selection entered already in oven and CLEAR/OFF button not pressed to cancel it.	• Press CLEAR/OFF .
	Cooking time not entered after pressing TIME COOK .	• Make sure you have entered cooking time after pressing TIME COOK .
	CLEAR/OFF was pressed accidentally.	• Reset cooking program and press START/PAUSE .
	Food weight not entered after selecting AUTO DEFROST or FAST DEFROST .	• Make sure you have entered food weight after selecting AUTO DEFROST or FAST DEFROST .
CONTROL LOCKED appears on display	Food type not entered after pressing AUTO COOK .	• Make sure you have entered a food type.
	The control has been locked.	• Press and hold CLEAR/OFF for about 3 seconds to unlock the control.
	OVEN TOO HOT FOR SENSOR COOKING---USING ALTERNATE METHOD appears on display	• These features will not operate when the oven is hot. The oven will automatically change to cook by time (follow the directions in the display) or once the oven is cool enough, the sensor features will function normally.
Floor of the oven is warm even when the oven has not been used	The cooktop light is located below the oven floor. When light is on, the heat it produces may make the oven floor get warm.	• This is normal.
You hear an unusual low-tone beep	You have tried to change the power level when it is not allowed.	• Many of the oven's features are preset and cannot be changed.
Oven emits a smoky odor and gray smoke after using the Bake feature	Oils on the stainless steel cavity are burning off after using the Bake feature the first few times.	• This is normal.

Problem	Possible Causes	What To Do
Food browns on top much faster than on the bottom	Rack has been placed in the “high” position.	<ul style="list-style-type: none"> • Always use the rack in its “low” position.
Oven temperature fluctuates during cooking	The cooking element cycles on and off to maintain the oven temperature at the desired setting.	<ul style="list-style-type: none"> • This is normal.
Vent fan comes on automatically	The vent fan automatically turns on to protect the microwave if it senses too much heat rising from the cooktop below.	<ul style="list-style-type: none"> • This is normal.
	During Bake, Roast or Fast Bake (after preheating), the vent fan will automatically come on to cool the oven components.	<ul style="list-style-type: none"> • This is normal.
SENSOR ERROR appears on the display	When using a Sensor feature, the door was opened before steam could be detected.	<ul style="list-style-type: none"> • Do not open door until steam is sensed and time is shown counting down on the display.
	Steam was not detected in a maximum amount of time.	<ul style="list-style-type: none"> • Use Time Cook to heat for more time.

Before you call for service...

Things That Are Normal With Your Microwave Oven

- Steam or vapor escaping from around the door.
- Light reflection around door or outer case.
- Dimming oven light and change in the blower sound at power levels other than high.
- Dull thumping sound while oven is operating.
- TV/radio interference might be noticed while using the microwave. Similar to the interference caused by other small appliances, it does not indicate a problem with the microwave. Plug the microwave into a different electrical circuit, move the radio or TV as far away from the microwave as possible, or check the position and signal of the TV/radio antenna.

GE Service Protection Plus™

GE, a name recognized worldwide for quality and dependability, offers you Service Protection Plus™—comprehensive protection on all your appliances—**No Matter What Brand!**

Benefits Include:

- Backed by GE
- All brands covered
- Unlimited service calls
- All parts and labor costs included
- No out-of-pocket expenses
- No hidden deductibles
- One 800 number to call

***We'll Cover Any Appliance.
Anywhere. Anytime.****

You will be completely satisfied with our service protection or you may request your money back on the remaining value of your contract. No questions asked. It's that simple.

Protect your refrigerator, dishwasher, washer and dryer, range, TV, VCR and much more—**any brand!** Plus there's no extra charge for emergency service and low monthly financing is available. Even icemaker coverage and food spoilage protection is offered. You can rest easy, knowing that all your valuable household products are protected against expensive repairs.

Place your confidence in GE and call us in the U.S. toll-free at **800.626.2224** for more information.

*All brands covered, up to 20 years old, in the continental U.S.

 Cut here

Please place in envelope and mail to:

General Electric Company
Warranty Registration Department
P.O. Box 32150
Louisville, KY 40232-2150

Consumer Product Ownership Registration

Dear Customer:

Thank you for purchasing our product and thank you for placing your confidence in us.

We are proud to have you as a customer!

Follow these three steps to protect your new appliance investment:

1

Complete and mail your Consumer Product Ownership Registration today. Have the peace of mind of knowing we can contact you in the unlikely event of a safety modification.

2

After mailing the registration below, store this document in a safe place. It contains information you will need should you require service. Our service number is 800.GE.CARES (800.432.2737).

3

Read your Owner's Manual carefully. It will help you operate your new appliance properly.

Model Number

Serial Number

Important: If you did not get a registration card with your product, detach and return the form below to ensure that your product is registered, or register online at ge.com.



Consumer Product Ownership Registration



Model Number

Serial Number

Mr. Ms. Mrs. Miss

First Name _____

Last Name _____

Street Address _____

Apt. # _____

E-mail Address* _____

City _____

State _____

Zip Code _____

Date Placed In Use Month _____

Day _____

Year _____

Phone Number _____

* Please provide your e-mail address to receive, via e-mail, discounts, special offers and other important communications from GE Appliances (GEA).

Check here if you do not want to receive communications from GEA's carefully selected partners.

FAILURE TO COMPLETE AND RETURN THIS CARD DOES NOT DIMINISH YOUR WARRANTY RIGHTS.

For more information about GEA's privacy and data usage policy, go to ge.com and click on "Privacy Policy" or call 800.626.2224.



GE Appliances

GE Consumer & Industrial Appliances
General Electric Company
Louisville, KY 40225
ge.com

GE Microwave Oven Warranty.

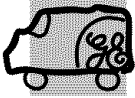

All warranty service provided by our Factory Service Centers, or an authorized Customer Care® technician. To schedule service, on-line, 24 hours a day, visit us at ge.com, or call 800.GE.CARES (800.432.2737).

Staple your receipt here.
Proof of the original purchase date is needed to obtain service under the warranty.

For The Period Of: GE Will Replace:

One Year
From the date of the original purchase **Any part** of the microwave oven which fails due to a defect in materials or workmanship. During this **full one-year warranty**, GE will also provide, **free of charge**, all labor and in-home service to replace the defective part.

Ten Years
From the second through the tenth year from the date of original purchase **The magnetron tube**, if the magnetron tube fails due to a defect in materials or workmanship. During this **additional nine-year limited warranty**, you will be responsible for any labor or in-home service costs.

What GE Will Not Cover:

- Service trips to your home to teach you how to use the product.
- Improper installation, delivery or maintenance.
- Failure of the product if it is abused, misused, or used for other than the intended purpose or used commercially.
- Replacement of the cooktop light bulbs.
- Replacement of house fuses or resetting of circuit breakers.
- Damage to the product caused by accident, fire, floods or acts of God.
- Incidental or consequential damage caused by possible defects with this appliance.
- Damage caused after delivery.

This warranty is extended to the original purchaser and any succeeding owner for products purchased for home use within the USA. In Alaska, the warranty excludes the cost of shipping or service calls to your home.

Some states do not allow the exclusion or limitation of incidental or consequential damages. This warranty gives you specific legal rights, and you may also have other rights which vary from state to state. To know what your legal rights are, consult your local or state consumer affairs office or your state's Attorney General.

Warrantor: General Electric Company, Louisville, KY 40225

Consumer Support.



GE Appliances Website

ge.com

Have a question or need assistance with your appliance? Try the GE Appliances Website 24 hours a day, any day of the year! For greater convenience and faster service, you can now download Owner's Manuals, order parts, catalogs, or even schedule service on-line. You can also "Ask Our Team of Experts™" your questions, and so much more...

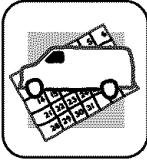

Schedule Service

ge.com

Expert GE repair service is only one step away from your door. Get on-line and schedule your service at your convenience 24 hours any day of the year! Or call 800.GE.CARES (800.432.2737) during normal business hours.

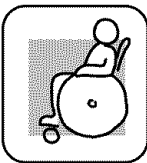

Real Life Design Studio

ge.com

GE supports the Universal Design concept—products, services and environments that can be used by people of all ages, sizes and capabilities. We recognize the need to design for a wide range of physical and mental abilities and impairments. For details of GE's Universal Design applications, including kitchen design ideas for people with disabilities, check out our Website today. For the hearing impaired, please call 800.TDD.GEAC (800.833.4322).



Extended Warranties

ge.com

Purchase a GE extended warranty and learn about special discounts that are available while your warranty is still in effect. You can purchase it on-line anytime, or call 800.626.2224 during normal business hours. GE Consumer Home Services will still be there after your warranty expires.

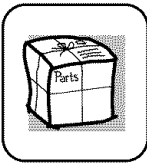

Parts and Accessories

ge.com

Individuals qualified to service their own appliances can have parts or accessories sent directly to their homes (VISA, MasterCard and Discover cards are accepted). Order on-line today, 24 hours every day or by phone at 800.626.2002 during normal business hours.

Instructions contained in this manual cover procedures to be performed by any user. Other servicing generally should be referred to qualified service personnel. Caution must be exercised, since improper servicing may cause unsafe operation.



Contact Us

ge.com

If you are not satisfied with the service you receive from GE, contact us on our Website with all the details including your phone number, or write to: General Manager, Customer Relations
GE Appliances, Appliance Park
Louisville, KY 40225



Register Your Appliance

ge.com

Register your new appliance on-line—at your convenience! Timely product registration will allow for enhanced communication and prompt service under the terms of your warranty, should the need arise. You may also mail in the pre-printed registration card included in the packing material.