

# KitchenAid™

## 6.9 L BOWL-LIFT STAND MIXER Instructions

**KÜCHENMASCHINE MIT SCHÜSSELHEBER UND 6,9-LITER-SCHÜSSEL**  
Bedienungsanleitung

**ROBOT SUR SOCLE À BOL RELEVABLE DE 6,9 LITRES**  
Instructions

**ROBOT DA CUCINA CON SOLLEVAMENTO CIOTOLA DA 6,9 L**  
Istruzioni

**6,9 L MULTIFUNCTIONELE MIXER/KEUKENROBOT  
MET IN DE HOOGTE VERSTELBARE KOM**  
Instructions

**BATIDORA DE PIE CON BOL ELEVABLE DE 6,9 L**  
Instrucciones

**BATEDEIRA COM SUPORTE PARA TAÇA DE 6,9 L**  
Instruções

**ΜΙΞΕΡ ΜΕ ΒΑΣΗ ΚΑΙ ΥΠΕΡΥΨΩΜΕΝΟ ΜΠΟΛ 6,9 L**  
Οδηγίες

**6,9 L KÖKSMASKIN MED SKÅL PÅ HÄVARM**  
Instruktioner

**6,9 L BOLLELØFTENDE KJØKKENMASKIN**  
Bruksanvisning

**6,9 L KULHONNOSTOMALLINEN YLEISKONE**  
Ohjeet

**6,9 L KØKKENMASKINE MED SKÅL-LØFT**  
Vejlledning

**6,9 L BORDHRÆRIVÉL MED LYFTANLEGRI SKÁL**  
Leiðbeiningar

**СТАЦИОНАРНЫЙ МИКСЕР СО СЪЕМНОЙ ЧАШЕЙ 6,9 Л**  
Инструкции

**STOJĄCE WIELOFUNKCYJNE MIKSERY PLANETARNE,  
Z PODNOSZONĄ DZIEŻĄ O POJEMNOŚCI 6,9 L**  
Instrukcja obsługi

**KUCHYŇSKÝ ROBOT SE ZVEDACÍ MÍSOU O OBJEMU 6,9 L**  
Návod

**KUCHYNSKÝ ROBOT SO ZDVÍHACOU MISOU O OBJEME 6,9 L**  
Návod

**MIXER CU SOCLU ŞI BOL DE 6,9 L**  
Instrucţiuni

**6,9 L КУХНЕНСКИ РОБОТ С ПОВДИГАЩА СЕ КУПА**  
Инструкции

Model 5KSM7580

Model 5KSM7591

# Table of Contents

## STAND MIXER SAFETY

Important Safeguards .....	3
Electrical Requirements .....	4
Electrical Waste Disposal .....	4

## PARTS AND FEATURES ..... 5

## SETTING UP YOUR STAND MIXER ..... 6

Assembling your Bowl-Lift Stand Mixer .....	6
Adjusting your Beater to Bowl Clearance .....	7

## USING YOUR STAND MIXER

Speed Control Guide - 10 Speed Stand Mixers .....	8
---	---

## ATTACHMENTS ..... 9

## CARE AND CLEANING ..... 9

## TIPS FOR GREAT RESULTS

Planetary Mixing Action .....	10
Mixing Time .....	10
Mixer Use.....	10
Mixing Tips.....	10
Whipping Tips for Egg Whites.....	11
Whipping Tips for Whipped Cream.....	11
Bread Making Tips .....	12

## SERVICE AND WARRANTY

When You Need Service .....	13
Household KitchenAid™ Bowl-Lift Stand Mixer Warranty .....	13
Service Centers.....	14
Customer Service .....	14

## Your safety and the safety of others are very important.

We have provided many important safety messages in this manual and on your appliance. Always read and obey all safety messages.



This is the safety alert symbol.

This symbol alerts you to potential hazards that can kill or hurt you and others.

All safety messages will follow the safety alert symbol and either the word "DANGER" or "WARNING." These words mean:

**! DANGER**

**You can be killed or seriously injured if you don't immediately follow instructions.**

**! WARNING**

**You can be killed or seriously injured if you don't follow instructions.**

All safety messages will tell you what the potential hazard is, tell you how to reduce the chance of injury, and tell you what can happen if the instructions are not followed.

## IMPORTANT SAFEGUARDS

**When using electrical appliances, basic safety precautions should always be followed, including the following:**

1. Read all instructions.
2. To avoid risk of electrical shock, do not put Stand Mixer in water or other liquid.
3. The appliance is not intended for use by young children or infirm persons without supervision.
4. Unplug Stand Mixer from outlet when not in use, before putting on or taking off parts, and before cleaning.
5. Avoid contacting moving parts. Keep hands, hair, and clothing, as well as spatulas and other utensils away from beater during operation to reduce the risk of injury to persons and/or damage to the Stand Mixer.
6. Do not operate Stand Mixer with a damaged cord or plug or after the Stand Mixer malfunctions, or is dropped or damaged in any manner. Return appliance to the nearest Authorized Service Center for examination, repair or electrical or mechanical adjustment.
7. The use of attachments not recommended or sold by KitchenAid may cause fire, electrical shock, or injury.
8. Do not use the Stand Mixer outdoors.
9. Do not let the cord hang over edge of table or counter.
10. Remove Flat Beater, Stainless Steel Whip, or Spiral Dough Hook from Stand Mixer before washing.

## SAVE THESE INSTRUCTIONS

**THIS PRODUCT IS DESIGNED FOR HOUSEHOLD  
USE ONLY.**

## Electrical Requirements

### **WARNING**



#### **Electrical Shock Hazard**

**Plug into a grounded outlet.**

**Do not remove ground prong.**

**Do not use an adapter.**

**Do not use an extension cord.**

**Failure to follow these instructions can result in death, fire, or electrical shock.**

Volts: 220-240 A.C.

Hertz: 50/60 Hz

**NOTE:** The power rating for your Stand Mixer is printed on the serial plate, placed under your Stand Mixer.

Do not use an extension cord. If the power supply cord is too short, have a qualified electrician or serviceman install an outlet near the appliance.

The wattage rating is determined by using the attachment that draws the greatest load (power). Other recommended attachments may draw significantly less power.

## Electrical Waste Disposal

This appliance is marked according to the European directive 2002/96/EC on Waste Electrical and Electronic Equipment (WEEE).

By ensuring this product is disposed of correctly, you will help avoid potential negative consequences for the environment and human health, which could otherwise be caused by inappropriate waste handling of this product.



The symbol  on the product, or on the documents accompanying the product, indicates that this appliance may not be treated as household waste. Instead it shall be handed over to the applicable collection point for the recycling of electrical and electronic equipment.

Disposal must be carried out in accordance with local environmental regulations for waste disposal.

For more detailed information about treatment, recovery and recycling of this product, please contact your local city office, your household waste disposal service or the shop where you purchased the product.

# Parts and Features

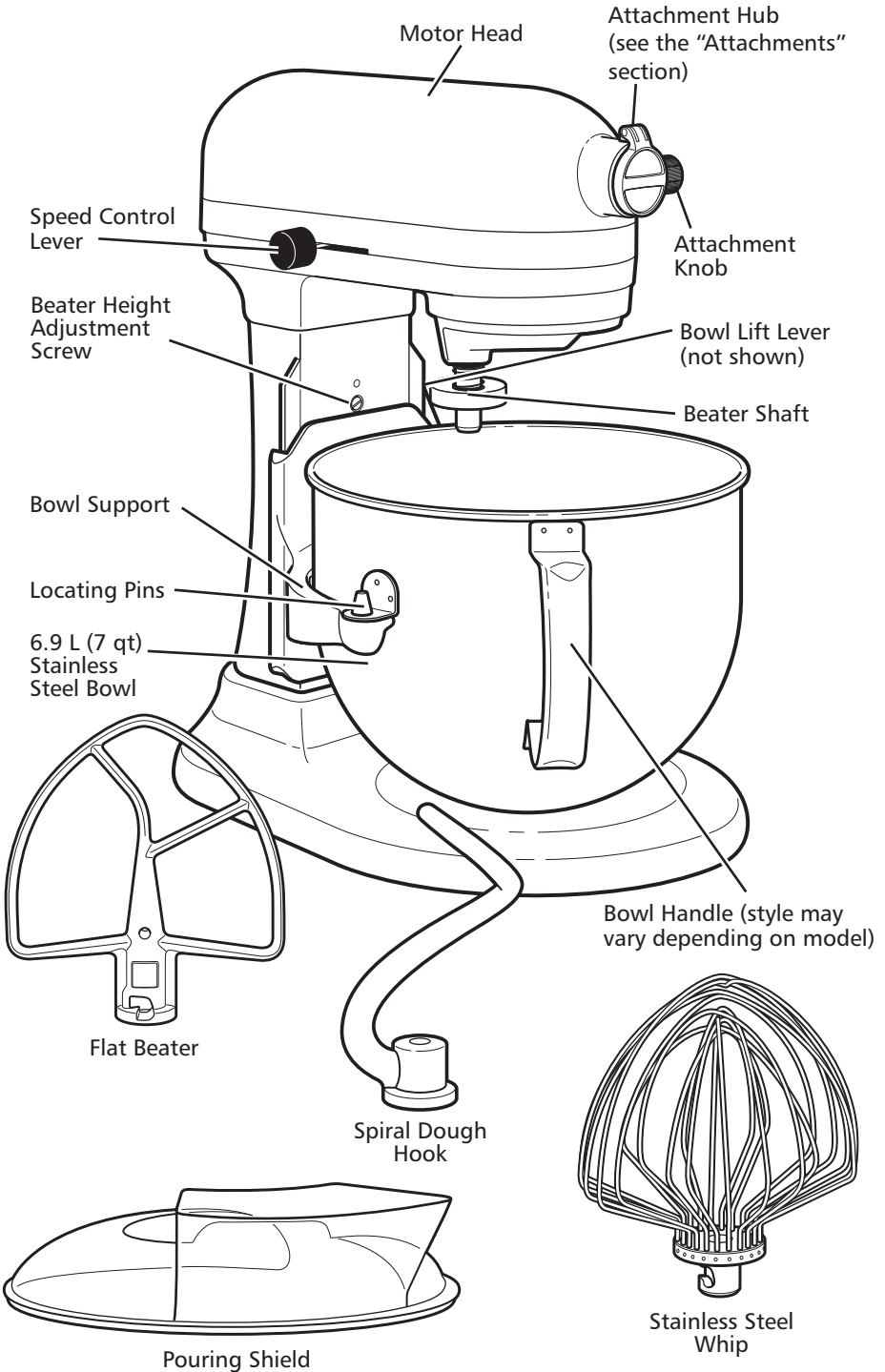

## Assembling your Bowl-Lift Stand Mixer

### To attach the Stainless Steel Bowl

Turn speed control to "0" (OFF). Unplug Stand Mixer or disconnect power. Place Bowl Lift Lever into down position. Fit Bowl Supports over Locating Pins and press down on back of the bowl until the Bowl Pin snaps into the Spring Latch. (Fig. 1)

**IMPORTANT:** If the bowl is not securely snapped into place, it will be unstable and wobble during use.

Fig. 1

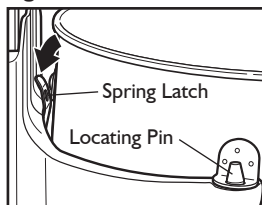

### To raise the Stainless Steel Bowl to mixing position

Rotate Bowl Lift Lever counterclockwise to the straight up position. (Fig. 2)  
The bowl must always be in the raised position when mixing.

Fig. 2

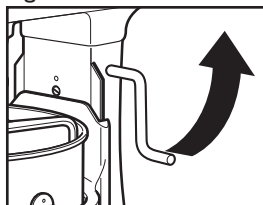

### To remove the Stainless Steel Bowl

Turn speed control to "0" (OFF). Unplug Stand Mixer or disconnect power. Place Bowl Lift Lever in down position. Grasp Bowl Handle and lift straight up and off Locating Pins.

## **⚠ WARNING**

### Injury Hazard

Unplug mixer before touching beaters.

Failure to do so can result in broken bones, cuts, or bruises.

### To attach Flat Beater, Stainless Steel Whip, or Spiral Dough Hook.

Turn speed control to "0" (OFF). Unplug Stand Mixer or disconnect power. Lower bowl by rotating Bowl Lift Lever downward. Slip beater on Beater Shaft and press upward as far as possible. Turn beater to right, hooking it over the Pin on the Beater Shaft. (Fig.3)

Fig. 3

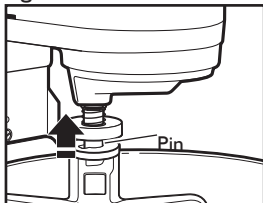

### To remove Flat Beater, Stainless Steel Whip or Spiral Dough Hook

Turn speed control to "0" (OFF). Unplug Stand Mixer or disconnect power. Lower bowl by rotating Bowl Lift Lever downward. Press beater upward as far as possible and turn left. Pull beater from Beater Shaft.

Fig. 4

### To attach Pouring Shield

Turn speed control to "0" (OFF). Unplug Stand Mixer or disconnect power. Attach Flat Beater, Spiral Dough Hook, or Stainless Steel Whip and bowl. From the front of the mixer, slide the Pouring Shield over the bowl until it is centered. The bottom rim of the Pouring Shield should fit within the bowl. (Fig. 4)

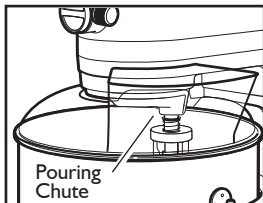

### To use Pouring Shield

For best results, rotate the Pouring Shield so the Motor Head covers the U-shaped gap in the shield. The Pouring Chute will be just to the right of the Attachment Hub as you face the mixer. Pour the ingredients into the bowl through the Pouring Chute.

## Adjusting your Beater to Bowl Clearance

Your Stand Mixer is adjusted at the factory so the Flat Beater just clears the bottom of the bowl. If, for any reason, the Flat Beater hits the bottom of the bowl or is too far away from the bowl, you can correct the clearance easily.

1. Turn speed control to "0" (OFF).
2. Unplug Stand Mixer or disconnect power.
3. Lower the bowl to the down position.
4. Turn Beater Height Adjustment Screw (A) slightly counter clockwise (left) to raise Flat Beater or clockwise (right) to lower Flat Beater.
5. Make adjustment with Flat Beater, so it just clears surface of the bowl.  
If you over adjust the screw, the Bowl Lift Lever may not lock into place.

**NOTE:** When properly adjusted, the Flat Beater will not strike on the bottom or side of the bowl. If the Flat Beater or the Stainless Steel Whip is so close that it strikes the bottom of the bowl, coating may wear off the Flat Beater (for coated beaters) or wires on Stainless Steel Whip may wear.

Scraping sides of bowl may be necessary under certain conditions regardless of beater adjustment. The Stand Mixer must be stopped to scrape bowl or damage to mixer may occur.

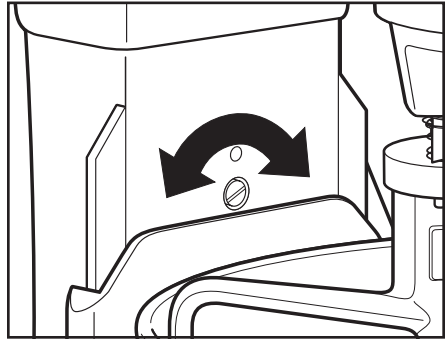



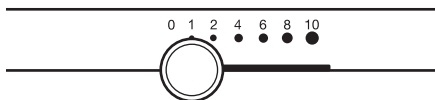

# Using your Stand Mixer

## Speed Control Guide - 10 Speed Stand Mixers

All speeds have the Soft Start feature that automatically starts the Stand Mixer at a lower speed to help avoid ingredient splash-out and “flour puff” at start-up, then quickly increases to the selected speed for optimal performance.



Speed	Used for	Accessories	Description
1	Stirring		For slow stirring, combining, mashing, starting all mixing procedures. Use to add flour and dry ingredients to batter, and add liquids to dry ingredients. Do not use Speed 1 to mix or knead yeast doughs.
2	Slow Mixing, Kneading		For slow mixing, mashing, faster stirring. Use to mix and knead yeast doughs, heavy batters, and candies; start mashing potatoes or other vegetables; cut shortening into flour; mix thin or splashy batters.
4	Mixing, Beating		For mixing semi-heavy batters, such as cookies. Use to combine sugar and shortening and to add sugar to egg whites for meringues. Medium speed for cake mixes.
6	Beating, Creaming		For medium-fast beating (creaming) or whipping. Use to finish mixing cake, doughnut, and other batters. High speed for cake mixes.
8-10	Fast Beating, Whipping, Fast Whipping		For whipping cream, egg whites, and boiled frostings. For whipping small amounts of cream, egg whites or for final whipping of mashed potatoes.

**NOTE:** Use Speed 2 to mix or knead yeast doughs. Use of any other speed creates high potential for Stand Mixer failure. The PowerKnead Spiral Dough Hook efficiently kneads most yeast dough within 4 minutes.

## Capacity Chart

	6.9 L Bowl
Flour	2 to 2.2 kg
Bread	8 breads of 450 g
Cookies / Biscuits	160 pieces
Mashed Potatoes	3.6 kg



## General Information

KitchenAid™ optional Attachments are designed to assure long life. The Attachment Power Shaft and Attachment Hub Socket are of a square design, to eliminate any possibility of slipping during the transmission of power to the attachment. The hub and shaft housings are tapered to assure a snug fit, even after prolonged use and wear. KitchenAid™ Attachments require no extra power unit to operate them; the power unit is built-in.

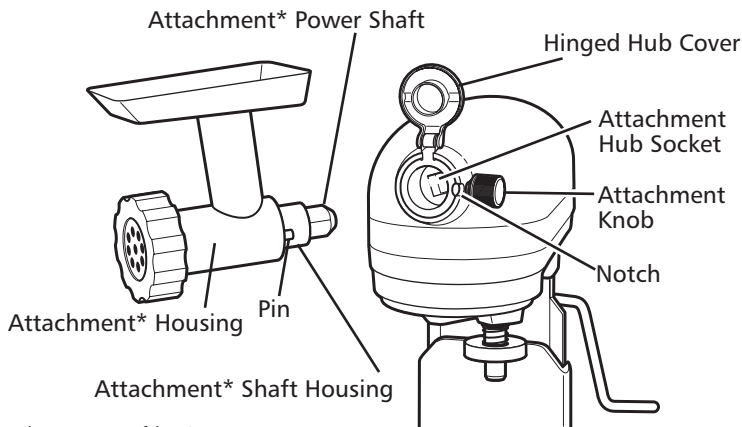

\* Optional Attachment, not part of the mixer.



## Care and Cleaning

Stainless Steel Bowl, Flat Beater, Stainless Steel Whip, and Spiral Dough Hook may be washed in an automatic dishwasher. Or, clean them thoroughly in hot sudsy water and rinse completely before drying. Do not store beaters on shaft.

### **⚠ WARNING**

**ELECTRICAL SHOCK HAZARD**  
**ALWAYS BE SURE TO UNPLUG MIXER BEFORE CLEANING TO AVOID POSSIBLE ELECTRICAL SHOCK.**

**Wipe mixer with a damp cloth. DO NOT IMMERSE IN WATER. Wipe off beater shaft frequently, removing any residue that may accumulate.**

Accessories	Coated Metal	Stainless Steel
	Silver coated metal beaters and dough hooks are dishwasher-safe. (Available on 5KSM7591 model)	Stainless steel beaters and dough hooks are dishwasher-safe. (Available on 5KSM7580 model)
	Not applicable	11-Wire Stainless Steel Elliptical Whips are dishwasher-safe. (Available on 5KSM7580 and 5KSM7591 models)
	Not applicable	All metal bowls are stainless steel and dishwasher-safe. (Available on all Bowl-Lift models)

## Planetary Mixing Action

During operation, the Flat Beater moves around the stationary bowl, at the same time turning in the opposite direction on its own axis.

The diagram shows the complete coverage

of the bowl made by the path of the beater.

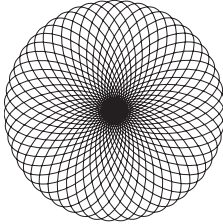

The 5KSM7580 and 5KSM7591 models are rated 500 Watts and use a Direct Current motor. It is a quiet and highly efficient motor, combined with a direct drive transmission system : this enables to drive 1.3 Horse Power at peak power (output motor power), enabling fast and outstanding mixing result even with heavy dough.

## Mixing Time

Your KitchenAid™ Mixer will mix faster and more thoroughly than most other electric mixers. Therefore, the mixing time in most recipes must be adjusted to avoid overbeating.

To help determine the ideal mixing time, observe the batter or dough and mix only until it has the desired appearance described in your recipe, such as “smooth and creamy.” To select the best mixing speeds, use the “Speed Control Guide” section.

## Mixer Use

### **WARNING**

#### **PERSONAL INJURY HAZARD**

**To avoid personal injury and damage to the beater, do not attempt to scrape bowl while mixer is operating; turn mixer off. Should scraper or other object drop into bowl, turn motor OFF before removing.**

The bowl and beater are designed to provide thorough mixing without frequent scraping. Scraping the bowl once or twice during mixing is usually sufficient.

The Stand Mixer may become warm during use. Under heavy loads with extended mixing time periods, you may not be able to comfortably touch the top of the Stand Mixer. This is normal.

## Mixing Tips

### **Adding Ingredients**

Always add ingredients as close to side of bowl as possible, not directly into moving beater. The Pouring Shield can be used to simplify adding ingredients. Use Speed I until ingredients have been blended. Then gradually increase to desired speed.

### **Adding Nuts, Raisins, or Candied Fruits**

Follow individual recipes for guidelines on including these ingredients. In general, solid materials should be folded in the last few seconds of mixing on Speed I. The batter should be thick enough to keep the fruit or nuts from sinking to the bottom of the pan during baking. Sticky fruits should be dusted with flour for better distribution in the batter.

### **Liquid Mixtures**

Mixtures containing large amounts of liquid ingredients should be mixed at lower speeds to avoid splashing. Increase speed only after mixture has thickened.

**NOTE:** If ingredients in very bottom of bowl are not thoroughly mixed, then the beater is not far enough into the bowl. See the “Setting Up Your Stand Mixer” section.

## Whipping Tips for Egg Whites

Place room temperature egg whites in clean, dry bowl. Attach stainless steel bowl and wire whip. To avoid splashing, gradually turn to designated speed and whip to desired stage. See chart below.

AMOUNT	SPEED
1 egg white .....	GRADUALLY to 10
2-4 egg whites .....	GRADUALLY to 8
6 or more egg whites .....	GRADUALLY to 8

### Whipping Stages

With your KitchenAid™ Stand Mixer, egg whites whip quickly. So watch to avoid over whipping. This list tells you what to expect.



#### Frothy

Large, uneven air bubbles.

#### Begins to Hold Shape

Air bubbles are fine and compact; product is white.



#### Soft Peak

Tips of peaks fall over when Stainless Steel Whip is removed.



#### Almost Stiff

Sharp peaks form when Stainless Steel Whip is removed, but whites are actually soft.

#### Stiff but not Dry

Sharp, stiff peaks form when Stainless Steel Whip is removed. Whites are uniform in colour and glisten.

#### Stiff and Dry

Sharp, stiff peaks form when Stainless Steel Whip is removed. Whites are speckled and dull in appearance.

## Whipping Tips for Whipped Cream

Pour cold whipping cream into chilled bowl. Attach stainless steel bowl and wire whip. To avoid splashing, gradually turn to designated speed and whip to desired stage. See chart below.

AMOUNT	SPEED
50-200 mL .....	GRADUALLY to 10
More than 200 mL .....	GRADUALLY to 8

### Whipping Stages

Watch cream closely during whipping. Because your KitchenAid™ Stand Mixer whips so quickly, there are just a few seconds between whipping stages. Look for these characteristics:

#### Begins to Thicken

Cream is thick and custard-like.

#### Holds its Shape

Cream forms soft peaks when Stainless Steel Whip is removed. Can be folded into other ingredients when making desserts and sauces.



#### Stiff

Cream stands in stiff, sharp peaks when Stainless Steel Whip is removed. Use for topping on cakes or desserts, or filling for cream puffs.

## Bread Making Tips

Making bread with a mixer is quite different from making bread by hand. Therefore, it will take some practice before you are completely comfortable with the new process. For your convenience, we offer these tips to help you become accustomed to bread-making the KitchenAid™ brand way.

- ALWAYS use the PowerKnead Spiral Dough Hook to mix and knead yeast doughs.
- Use Speed 2 to mix or knead yeast dough. Use of any other speed with heavy doughs may cause mixer to stop rotating to limit mixer damage. This is normal operation. If this occurs, turn the Speed Control Lever to off, and then turn back on to a lower speed.
- Use a candy or other kitchen thermometer to assure that liquids are at temperature specified in the recipe. Liquids at higher temperature can kill yeast, while liquids at lower temperatures will retard yeast growth.
- Warm all ingredients to room temperature to ensure proper rising of dough. If yeast is to be dissolved in bowl, always warm bowl first by rinsing with warm water to avoid cooling of liquids.
- Allow bread to rise in a warm place, 26°C to 29°C, free from draft, unless otherwise specified in recipe.
- Recipe rising times may vary due to temperature and humidity in your kitchen. Dough has doubled in bulk when indentation remains after tips of fingers are pressed lightly and quickly into dough.
- Most bread recipes give a range for the amount of flour to be used. Enough flour has been added when the dough starts to clean sides of bowl. If dough is sticky or humidity is high, slowly add more flour, about 60g (1/2 cup) at a time but do not exceed recommended flour capacity. Knead after each addition until flour is completely worked into dough. If too much flour is added, a dry loaf will result.
- When done, yeast breads and rolls should be deep golden brown in colour. Other tests for doneness of breads are: Bread pulls away from the sides of pan, and tapping on the top of the loaf produces a hollow sound. Turn loaves and rolls onto racks immediately after baking to avoid sogginess.

## When You Need Service



### ! WARNING

**Electrical Shock Hazard**

**Unplug before servicing.**

**Failure to do so can result in death or electrical shock.**

**Please read the following before calling your service center.**

- I. The Stand Mixer may warm up during use. Under heavy loads with extended mixing time periods, you may not be able to comfortably touch the top of the unit. This is normal.

2. The Stand Mixer may emit a pungent odor, especially when new. This is common with electric motors.
3. If the Flat Beater hits the Bowl, stop the Stand Mixer. See the “Setting Up Your Stand Mixer” section.

**If your Stand Mixer should malfunction or fail to operate, please check the following:**

- Is the Stand Mixer plugged in?
- Is the fuse in the circuit to the Stand Mixer in working order? If you have a circuit breaker box, be sure the circuit is closed.
- Turn off the Stand Mixer for 10-15 seconds, then turn it back on. If the mixer still does not start, allow it to cool for 30 minutes before turning it back on.
- If the problem is not due to one of the above items, see the “Service Centers” section.

## Household KitchenAid™ Bowl-Lift Stand Mixer Warranty

Length of Warranty:	KitchenAid Will Pay For:	KitchenAid Will Not Pay For:
<p><b>Europe, Australia and New Zealand:</b></p> <p>For the Artisan™ Mixer 5KSM7580: Five years Full Warranty from date of purchase.</p> <p>For the Heavy Duty Mixer 5KSM7591: One Year Full Warranty from date of purchase.</p>	<p>The replacement parts and repair labor costs to correct defects in materials or workmanship. Service must be provided by an Authorized KitchenAid Service Center.</p>	<p>A. Repairs when Stand Mixer is used for operations other than normal household food preparation.</p> <p>B. Damage resulting from accident, alterations, misuse, abuse, or installation/operation not in accordance with local electrical codes.</p>

**KITCHENAID DOES NOT ASSUME ANY RESPONSIBILITY FOR INDIRECT DAMAGES.**

## Service Centers

All service should be handled locally by an Authorized KitchenAid Service Center. Contact the dealer from whom the unit was purchased to obtain the name of the nearest Authorized KitchenAid Service Center.

### In the U.K.:

Call: 0845 6011 287

### In Ireland:

M.X. ELECTRIC  
Service Department  
25 Alymer Crescent  
Kilcock, Co. KILDARE

Call: 87 2581574

Fax: 1 628 4368

### In Australia:

Call: 1800 990 990

### In New Zealand:

Call: 0800 881 200

## Customer Service

### In U.K. & Ireland:

Tollfree number 0800 988 1266

(Calls from mobile phones are charged standard network rate)

### Address:

KitchenAid Europa, Inc.  
PO BOX 19  
B-2018 ANTWERP 11  
BELGIUM

### For Southern Ireland:

Tollfree number +44 (0) 20 8616 5148

[www.KitchenAid.co.uk](http://www.KitchenAid.co.uk)  
[www.KitchenAid.eu](http://www.KitchenAid.eu)



FOR THE WAY IT'S MADE.™

® Registered Trademark of KitchenAid, U.S.A.

™ Trademark of KitchenAid, U.S.A.

The shape of the Stand Mixer is a trademark of KitchenAid, U.S.A.

© 2011. All rights reserved.

Specifications subject to change without notice.

