



# Dryers

**Safety Instructions** ..... 2-5

**Operating Instructions**

Control Panels ..... 6-8

Cycle Options ..... 9, 10

Dryer Features ..... 11

Loading and Using  
the Dryer ..... 17, 18

Reversing the Door Swing ..... 12-16

Venting the Dryer ..... 19

Stacking ..... 20-23

**Troubleshooting Tips** ..... 24-26

**Consumer Support**

Consumer Support ..... Back Cover

Warranty ..... 27

**Owner's Manual**

DCVH515

DHDVH52

DBVH512

*Write the model and serial numbers here:*

**Model #** \_\_\_\_\_

**Serial #** \_\_\_\_\_

They are on the label on the front of the dryer behind the door.



## **IMPORTANT SAFETY INFORMATION. READ ALL INSTRUCTIONS BEFORE USING.**

### **⚠ WARNING!**

*For your safety, the information in this manual must be followed to minimize the risk of fire or explosion, electric shock, or to prevent property damage, personal injury, or death.*

- *Do not store or use gasoline or other flammable vapors and liquids in the vicinity of this or any other appliance.*
- *Installation and service must be performed by a qualified installer, service agency or the gas supplier.*

### **WHAT TO DO IF YOU SMELL GAS:**

- 1 *Do not try to light a match, or cigarette, or turn on any gas or electrical appliance.*
- 2 *Do not touch any electrical switch; do not use any phone in your building.*
- 3 *Clear the room, building or area of all occupants.*
- 4 *Immediately call your gas supplier from a neighbor's phone. Follow the gas supplier's instructions carefully.*
- 5 *If you cannot reach your gas supplier, call the fire department.*

#### *California Safe Drinking Water and Toxic Enforcement Act*

This act requires the governor of California to publish a list of substances known to the state to cause cancer, birth defects or other reproductive harm and requires businesses to warn customers of potential exposure to such substances.

Gas appliances can cause minor exposure to four of these substances, namely benzene, carbon monoxide, formaldehyde and soot, caused primarily by the incomplete combustion of natural gas or LP fuels.

Properly adjusted dryers will minimize incomplete combustion. Exposure to these substances can be minimized further by properly venting the dryer to the outdoors.



## PROPER INSTALLATION

This dryer must be properly installed and located in accordance with the Installation Instructions before it is used. If you did not receive an Installation Instructions sheet, you can receive one by visiting [ge.com](http://ge.com), or by calling **800.GE.CARES** (800.432.2737).

- Properly ground dryer to conform with all governing codes and ordinances. Follow details in Installation Instructions.
- Install or store where it will not be exposed to temperatures below freezing or exposed to the weather.
- Connect to a properly rated, protected and sized power supply circuit to avoid electrical overload.
- Remove the colored protective film from both the control panel and the door.
- Remove all sharp packing items and dispose of all shipping materials properly.
- Do not remove the vent protector from the back of the dryer.
- Pull the protector out and down to its lowest position and connect the exhaust duct to the dryer. The lowered protector will prevent the duct from getting crushed.

### Exhaust/Ducting:

- 1 Dryers **MUST** be exhausted to the outside to prevent large amounts of moisture and lint from being blown into the room.
- 2 Use only rigid metal or flexible metal 4" diameter ductwork inside the dryer cabinet or for exhausting to the outside. **USE OF PLASTIC OR OTHER COMBUSTIBLE DUCTWORK CAN CAUSE A FIRE. PUNCTURED DUCTWORK CAN CAUSE A FIRE IF IT COLLAPSES OR BECOMES OTHERWISE RESTRICTED IN USE OR DURING INSTALLATION.**

For complete details, follow the Installation Instructions.

# IMPORTANT SAFETY INFORMATION. READ ALL INSTRUCTIONS BEFORE USING.

## ⚠ **WARNING!**



### YOUR LAUNDRY AREA

- Keep the area underneath and around your appliances free of combustible materials (lint, paper, rags, etc.), gasoline, chemicals and other flammable vapors and liquids.
- Keep the floor around your appliances clean and dry to reduce the possibility of slipping.
- Close supervision is necessary if this appliance is used by or near children. Do not allow children to play on, with or inside this or any other appliance.
- Keep all laundry aids (such as detergents, bleaches, etc.) out of the reach of children, preferably in a locked cabinet. Observe all warnings on container labels to avoid injury.
- Never climb on or stand on the dryer top.



### WHEN USING YOUR DRYER

- Never reach into the dryer while the drum is moving. Before loading, unloading or adding clothes, wait until the drum has completely stopped.
- Clean the lint filter before each load to prevent lint accumulation inside the dryer or in the room. **DO NOT OPERATE THE DRYER WITHOUT THE LINT FILTER IN PLACE.**
- Do not wash or dry articles that have been cleaned in, washed in, soaked in or spotted with combustible or explosive substances (such as wax, oil, paint, gasoline, degreasers, dry-cleaning solvents, kerosene, etc.) which may ignite or explode. Do not add these substances to the wash water. Do not use or place these substances around your washer or dryer during operation.
- Do not place items exposed to cooking oils in your dryer. Items contaminated with cooking oils may contribute to a chemical reaction that could cause a clothes load to catch fire.
- Any article on which you have used a cleaning solvent or that contains flammable materials (such as cleaning cloths, mops, towels used in beauty salons, restaurants or barber shops, etc.) must not be placed in or near the dryer until solvents or flammable materials have been removed. There are many highly flammable items used in homes such as acetone, denatured alcohol, gasoline, kerosene, some household cleaners, some spot removers, turpentine, waxes, wax removers and products containing petroleum distillates.
- The laundry process can reduce the flame retardancy of fabrics. To avoid such a result, carefully follow the garment manufacturer's care instructions.
- Do not dry articles containing rubber, plastic, foam or similar materials such as padded bras, tennis shoes, galoshes, bath mats, rugs, bibs, baby pants, plastic bags, pillows, etc., that may melt or burn. Some rubber materials, when heated, can under certain circumstances produce fire by spontaneous combustion.
- Do not store plastic, paper or clothing that may burn or melt on top of the dryer during operation.
- Garments labeled *Dry Away from Heat* or *Do Not Tumble Dry* (such as life jackets containing kapok) must not be put in your dryer.
- Do not dry fiberglass articles in your dryer. Skin irritation could result from the remaining particles that may be picked up by clothing during subsequent dryer uses.
- To minimize the possibility of electric shock, unplug this appliance from the power supply or disconnect the dryer at the building's distribution panel by removing the fuse or switching off the circuit breaker before attempting any maintenance or cleaning (except the removal and cleaning of the lint filter). **NOTE:** Pressing **START**, **STOP** or **POWER** does **NOT** disconnect the appliance from the power supply.



## WHEN USING YOUR DRYER (cont.)

- Never attempt to operate this appliance if it is damaged, malfunctioning, partially disassembled, or has missing or broken parts, including a damaged cord or plug.
- The interior of the machine and the exhaust duct connection inside the dryer should be cleaned at least once a year by a qualified technician. See the *Loading and Using the Dryer* section.
- If yours is a gas dryer, it is equipped with an automatic electric ignition and does not have a pilot light. **DO NOT ATTEMPT TO LIGHT WITH A MATCH.** Burns may result from having your hand in the vicinity of the burner when the automatic ignition turns on.
- You may wish to soften your laundered fabrics or reduce the static electricity in them by using a dryer-applied fabric softener or an anti-static conditioner. We recommend you use either a fabric softener in the wash cycle, according to the manufacturer's instructions for those products, or try a dryer-added product for which the manufacturer gives written assurance on the package that their product can be safely used in your dryer. Service or performance problems caused by use of these products are the responsibility of the manufacturers of those products and are not covered under the warranty to this appliance.



## WHEN NOT USING YOUR DRYER

- Grasp the plug firmly when disconnecting this appliance to avoid damage to the cord while pulling. Place the cord away from traffic areas so it will not be stepped on, tripped over or subjected to damage.
- Do not attempt to repair or replace any part of this appliance or attempt any servicing unless specifically recommended in this Owner's Manual or in published user-repair instructions that you understand and have the skills to carry out.
- Before discarding a dryer, or removing it from service, remove the dryer door to prevent children from hiding inside.
- Do not tamper with controls.



READ AND FOLLOW THIS SAFETY INFORMATION CAREFULLY.

**SAVE THESE INSTRUCTIONS**

# About the dryer control panel.

You can locate your model number at the top inside of the door opening.

## Model DHDVH52

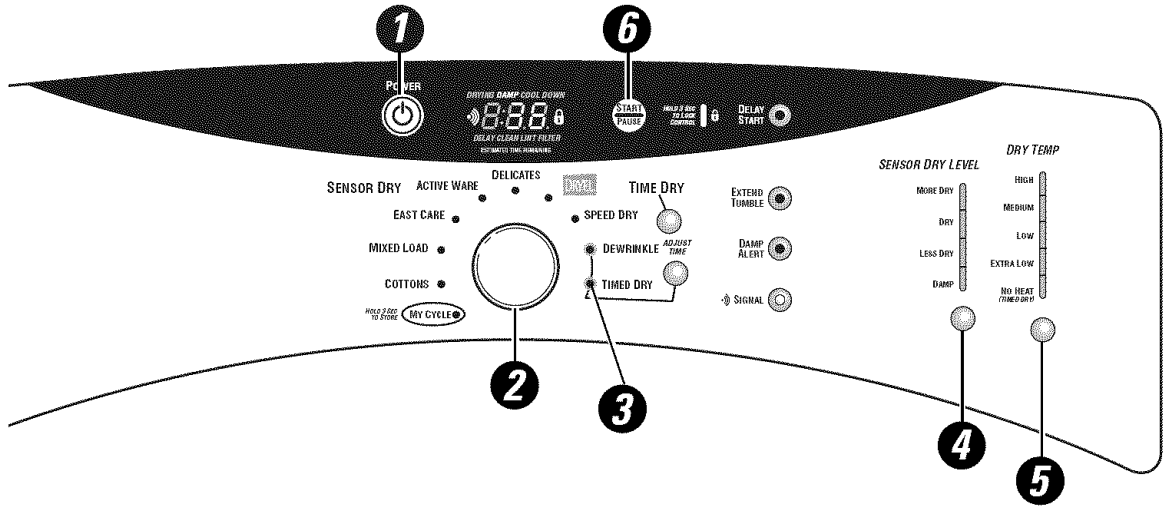

## Model DCVH515

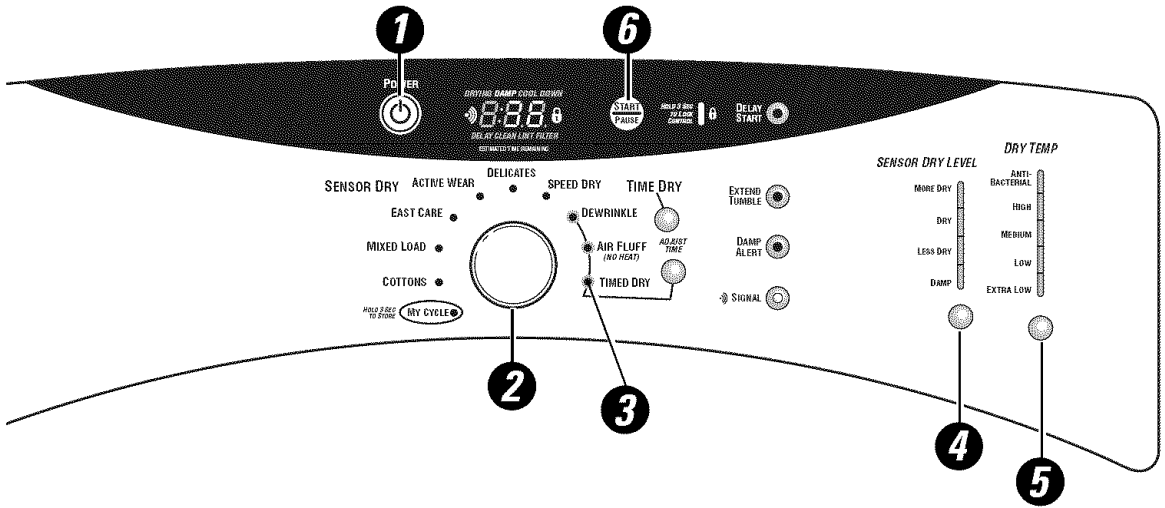

## Model DBVH512

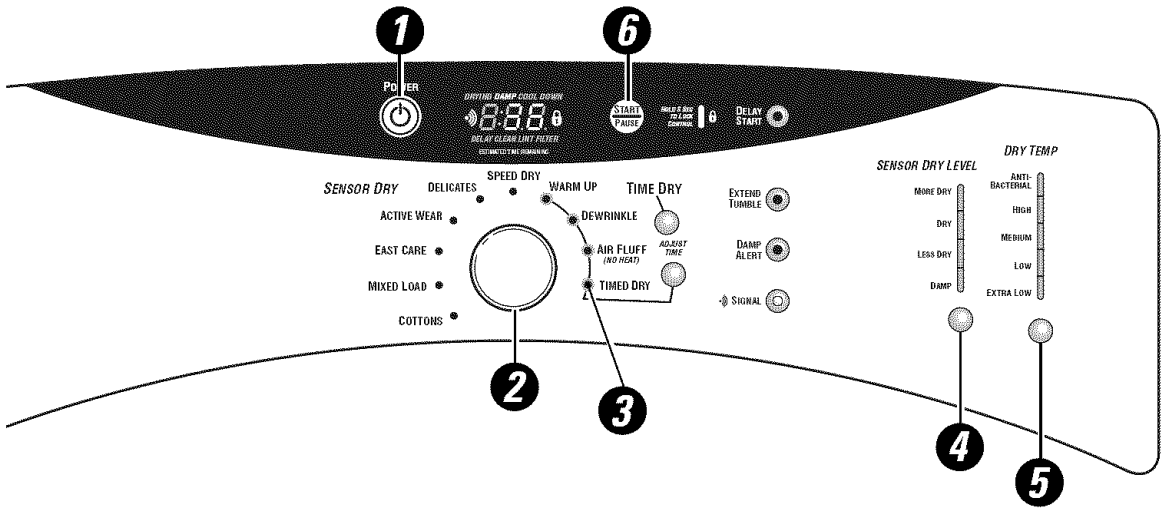

- 1 Power**  
Press to “wake up” the display. If the display is active, press to put the dryer in the standby mode.

**NOTE:** Pressing **POWER** does not disconnect the appliance from the power supply.

- 2 Dry Cycles**  
The dry cycle controls the length and tumble speed of the drying process. The chart below will help you match the dry setting with the loads.

#### Sensor Cycles

<b>COTTONS</b>	For cottons and most linens.
<b>MIXED LOAD</b>	For loads consisting of cottons and poly-blends.
<b>EASY CARE</b>	For wrinkle-free and permanent press items.
<b>ACTIVE WEAR</b>	Clothing worn for active sports exercise and some casual wear. Fabrics include new technology finishes and stretch fibers such as Spandex.
<b>DELICATES</b>	For lingerie and special-care fabrics.
<b>DRYEL™</b>	Designed for use with the DRYEL™ “dry clean only” fabric care system. See product package for directions. For questions or issues related to use and performance of DRYEL™, see the Website at: <a href="http://www.dryel.com">www.dryel.com</a> .
<b>SPEED DRY</b>	For small loads that are needed in a hurry, such as sports or school uniforms. Can also be used if the previous cycle left some items damp, such as collars or waistbands.

#### Timed Dry Cycles

<b>DEWRINKLE</b>	For removing wrinkles from items that are dry or slightly damp. This cycle is not recommended for delicate fabrics.
<b>WARM UP</b>	Provides 10 minutes of warming time to warm up clothes.
<b>AIR FLUFF</b>	Use this feature to tumble items without heat.

#### My Cycle (on some models)

<b>MY CYCLE</b>	Press to use, create or modify custom dry cycles.
-----------------	---

- 3 Timed Dry**  
Use to set your own dry time. **TIMED DRY** is also recommended for small loads.

#### To use TIMED DRY:

1. Turn dry cycle dial to **TIMED DRY**.
2. Select the drying time by pressing the **+** and **-** buttons.
3. Select the **DRY TEMP**.
4. Close the door.
5. Press **START**.

- 4 Sensor Dry Level**  
The sensor continuously monitors the amount of moisture in the load. When the moisture in your clothes reaches your selected dry level, the dryer will stop.

<b>MORE DRY</b>	Use for heavy or mixed type of fabrics.
<b>DRY</b>	Use for normal dryness level suitable for most loads. This is the preferred cycle for energy saving.
<b>LESS DRY</b>	Use for lighter fabric (ideal for ironing).
<b>DAMP</b>	For leaving items partially damp.

## About the dryer control panel.

### 5 Dry Temp

You can change the temperature of your dry cycle.

**ANTI-BACTERIAL** This option may only be used with **COTTONS** or **MIXED LOAD** cycles. This option reduces certain types of bacteria by 99.9%, including: *Staphylococcus aureus*, *Pseudomonas aeruginosa* and *Klebsiella pneumoniae*\*. The anti-bacterial process occurs when high heat is used during a portion of this drying cycle.

**NOTE:** Do not use this cycle on delicate fabrics.

\* The Anti-Bacterial Cycle is Certified by NSF International (formerly National Sanitation Foundation) to NSF Protocol *P154 Sanitization Performance of Residential Clothes Dryers*.



NSF Protocol P154  
Sanitization Performance of  
Residential Clothes Dryers

<b>HIGH</b>	For regular to heavy cottons.
<b>MEDIUM</b>	For synthetics, blends and items labeled permanent press.
<b>LOW</b>	For delicates, synthetics and items labeled <i>Tumble Dry Low</i> .
<b>EXTRA LOW</b>	For lingerie and special-care fabrics.
<b>NO HEAT</b>	Can only be used with <b>TIMED DRY</b> .

### 6 START

Press to start a dry cycle. If the dryer is running, press it once and it will pause the dryer. Press it again to restart the dry cycle.

#### **My Cycle** (on some models)

Set up your favorite combination of settings and save them here for one touch recall. These custom settings can be set while a cycle is in progress.

#### **To store a MY CYCLE combination of settings:**

1. Select your drying cycle.
2. Change **DRY TEMP** and **SENSOR DRY LEVEL** settings to fit your needs.
3. Select any drying **OPTIONS** you want.
4. Press and hold the  pad for three seconds to store your selection. A beep will sound and the pad will light up.

#### **To recall your stored MY CYCLE combination:**

Press the **MY CYCLE** button before drying a load.

#### **To change your stored MY CYCLE combination:**

Follow steps 1–4 in “**To store a MY CYCLE combination of settings**”.



# About cycle options.

**NOTE:** Not all features are available on all dryer models.

ge.com

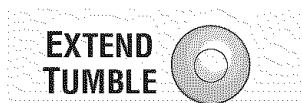

## Extend Tumble

Minimizes wrinkles by adding approximately 60 minutes of no-heat tumbling after clothes are dry. The beeper will sound every 2 minutes to remind you to remove the clothes. The **ESTIMATED TIME REMAINING** display will show **00**.



## Damp Alert

This option causes the dryer to beep when clothes have dried to a damp level. Remove items that you wish to hang dry. The **DAMP ALERT** will only beep when this option is selected.

Removing clothes and hanging them when they are damp can reduce the need to iron some items.



## Signal

Alerts you that the cycle is complete. The beeper will continue to sound every two minutes for the next 6 minutes, until the clothes have been removed. The clothes should be removed when the beeper goes off so wrinkles don't set in.

Press **SIGNAL** to select low, medium or high volume, or to turn the beeper off.

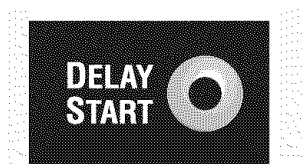

## Delay Start

Use to delay the start of your dryer.

1. Choose your dry cycle and any options.
2. Press **DELAY START**. You can change the delay time in 1 hour increments using the **+** or **-** arrow pads.
3. Press the **START** pad to start the countdown.

The countdown time will be shown in the **ESTIMATED TIME REMAINING** display.

**NOTE:** If the door is opened while the dryer is in **DELAY**, the countdown time will not restart unless the door is closed and **START** has been pressed again.

## About cycle options. *NOTE: Not all features are available on all dryer models.*

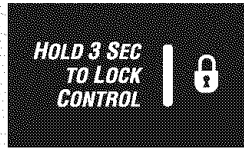

### Lock

You can lock the controls to prevent any selections from being made. Or you can lock the controls after you have started a cycle.

*Children cannot accidentally start the dryer by touching pads with this option selected.*

To lock the dryer, press and hold the lock icon for 3 seconds. To unlock the dryer, press and hold the lock icon for 3 seconds.

The icon of the lock next to the timer will light up when the controls are locked.



### Estimated Time Remaining

Displays the approximate time remaining until the end of the cycle.

As the cycle begins, you will see an initial approximate total cycle time in the display. Then lights will “race” in the display. This means the dryer is continuously monitoring the amount of moisture in the load. The lights will continue until the dryer senses a low level of moisture in the load. At that point, the dryer will calculate and display the approximate time remaining.



### My Cycle (on some models)

To save a favorite cycle, set the desired settings and hold down the **MY CYCLE** button for 3 seconds. A beep will sound to indicate the cycle has been saved.

To use your custom cycle, press the **MY CYCLE** button before drying a load.

To change the saved cycle, set the desired settings and hold down the **MY CYCLE** button for 3 seconds.

See page 8 for more details.

## Drum Lamp

Before replacing the light bulb, be sure to unplug the dryer power cord or disconnect the dryer at the household distribution panel by removing the fuse or switching off the circuit breaker. Reach above dryer opening from inside the drum. Remove the bulb and replace with the same size bulb.

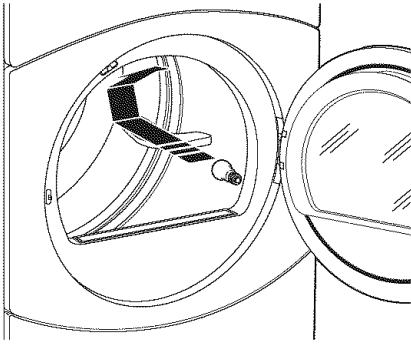

## Drying Rack (on some models)

A handy drying rack may be used for drying delicate items such as washable sweaters. Place items flat on the drying rack and block such items as wool sweaters and delicate fabrics. Dry with low heat.

To install the drying rack, pull up the lint filter slightly. Insert the drying rack into the slots, then push the filter back down.

### NOTE:

- The drying rack must be used with the **TIMED DRY** or **RACK DRY** (on some models) cycles.
- Do not use this drying rack when there are other clothes in the dryer.

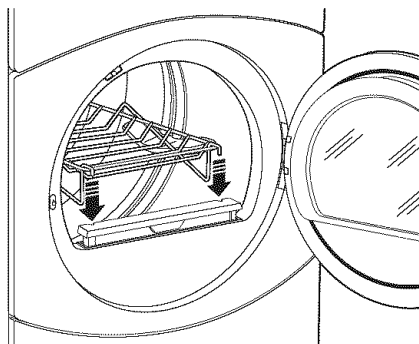

## Reversing the door swing.

### IMPORTANT NOTES:

- Read the instructions all the way through before starting.
- Handle parts carefully to avoid scratching paint.
- Set screws down by their related parts to avoid using them in the wrong places.
- Provide a non-scratching work surface for the doors.
- Normal completion time to reverse the door swing is 30–60 minutes.

**IMPORTANT:** Once you begin, do not move the cabinet until door-swing reversal is completed.

These instructions are for changing the hinges from the right side to the left side—if you ever want to switch them back to the right side, follow these same instructions and reverse all references to the left and right.

## TOOLS YOU WILL NEED



Adjustable Crescent Wrench



Phillips Head Screwdriver

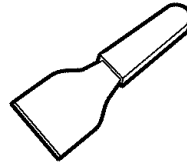

Putty Knife or  
Thin-Blade Screwdriver

## DOOR PARTS

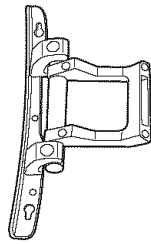

Hinge Assembly



Hinge  
Cover

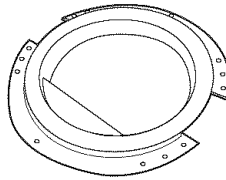

Plastic Cover

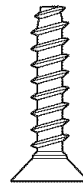

Large Tapping Screw  
(#10) – 6

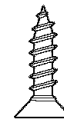

Tapping Screw (#8) – 2



Machine Screw (#8) – 6



Nut (#8) – 2



Washer – 2

## STEP-BY-STEP INSTRUCTIONS

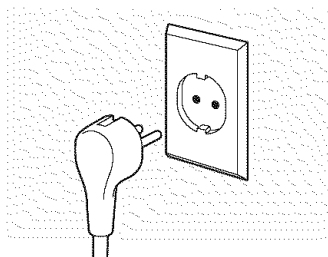

### Before You Start

1. Unplug the dryer from its electrical outlet.

## STEP-BY-STEP INSTRUCTIONS (cont.)

### Remove Door Assembly

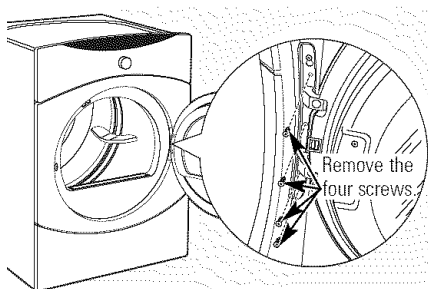

2. Open the door to approximately 90 degrees. Remove the 4 screws starting from the bottom to the top. Make sure the door is supported while removing the screws.

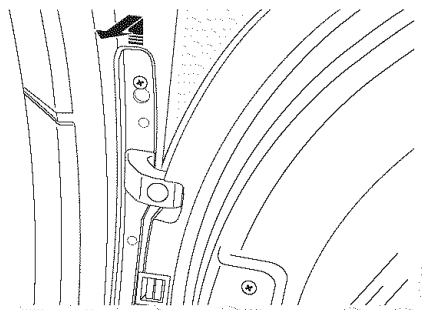

3. Loosen the top screw as shown. Unhook the door by lifting and pulling as shown by the arrows.

4. Lay the door down on a soft protected flat surface so that the inner part faces upward (door resting on the handle side).

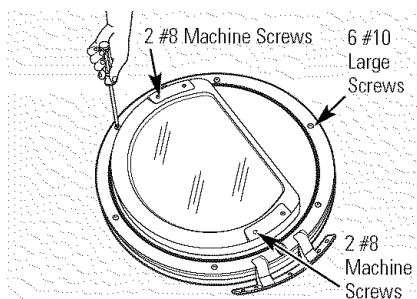

5. Remove the 6 large tapping screws (#10) located around the perimeter of the door outlining the gasket, and the 2 machine screws (#8) on the hinge side.

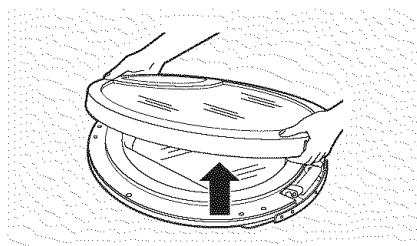

6. With the screws removed, turn the door over and separate the silver cover part of the door from the door frame and set aside.

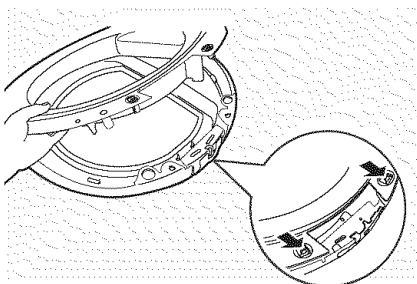

7. Unlock the 4 tabs on the plastic cover and separate the plastic cover from the frame.

**NOTE:** Disregard the “DO NOT REMOVE” label on the plastic cover.

## Reversing the door swing.

### STEP-BY-STEP INSTRUCTIONS (cont.)

#### Remove Hinge

**IMPORTANT:** Note the location of the hinge (left or right) before removing.

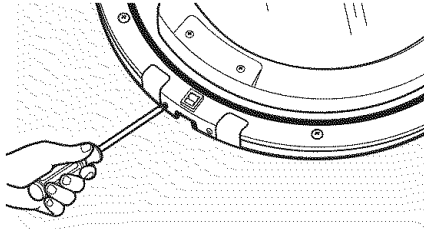

8. With the door frame part of the door laid down on a protected soft surface, remove the hinge cover by removing the 2 tapping screws (#8) that fasten it to the frame. The hinge cover is located at the opposite side of the hinge assembly.

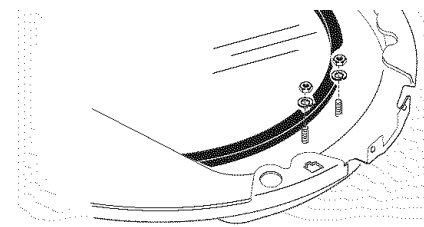

9. Remove the 2 nuts, washers and the 2 machine screws (#8).

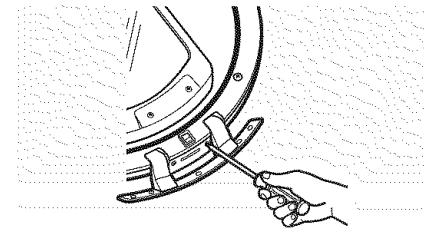

10. Remove the hinge assembly by removing the 2 machine screws (#8) that fasten it to the frame. Pull the hinge assembly out and set it aside.

#### Reinstall Hinge Assembly

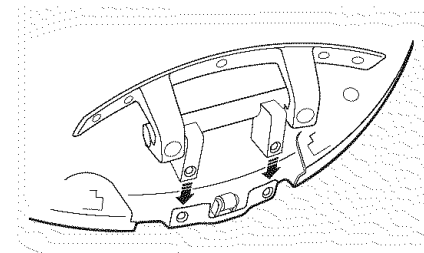

11. Place the hinge assembly in the opposite side of the door. Align the hinge holes with the door holes.

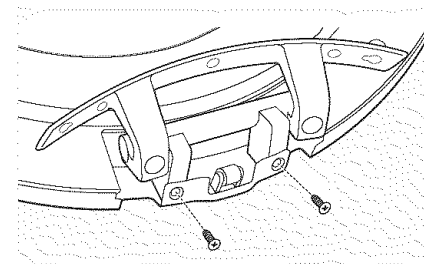

12. Loosely fasten the hinge assembly to the edge using 2 machine screws (#8).

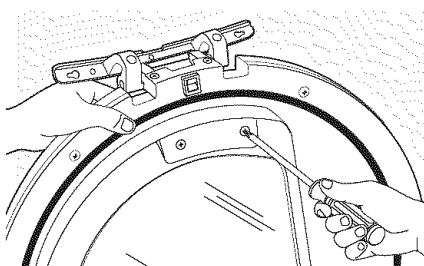

13. Hold the door on its side with one hand and fasten the remaining 2 screws as shown. Then tighten the 2 screws (#8) holding the hinge assembly.

## STEP-BY-STEP INSTRUCTIONS (cont.)

### Reinstall Nuts and Hinge Cover

**14.** Place the door on its edge. Assemble the 2 machine screws (#8), washers and nuts. Tighten using a wrench and screwdriver.

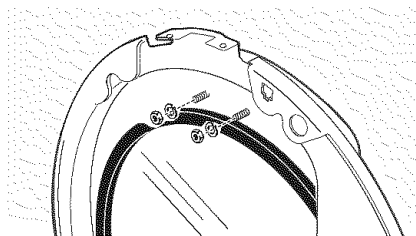

**15.** Place the hinge cover in position. Align the hinge cover holes with the holes in the door.

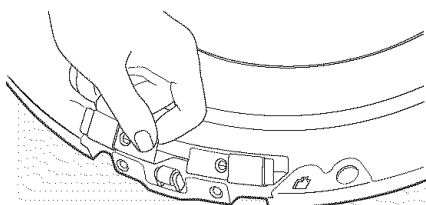

**16.** Secure the hinge cover with the 2 tapping screws (#8).

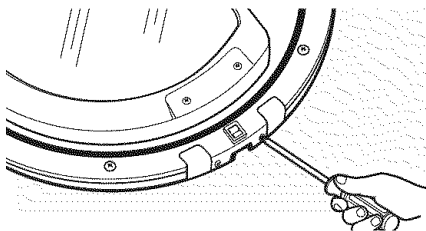

### Reassemble Door Assembly

**IMPORTANT:** Make sure there is no dirt or any other foreign material in between the window panes.

**17.** Place the plastic cover onto the inner door and lock in place with the 4 tabs.

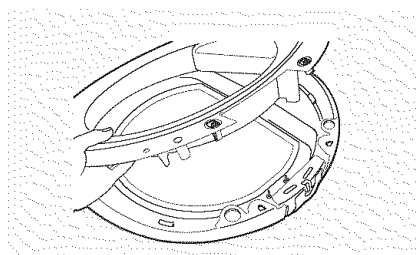

**18.** Place the outer door onto the inner door.

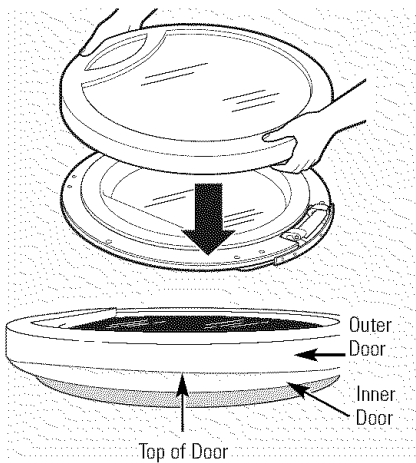

## Reversing the door swing.

### STEP-BY-STEP INSTRUCTIONS (cont.)

#### Reassemble Door Assembly (cont.)

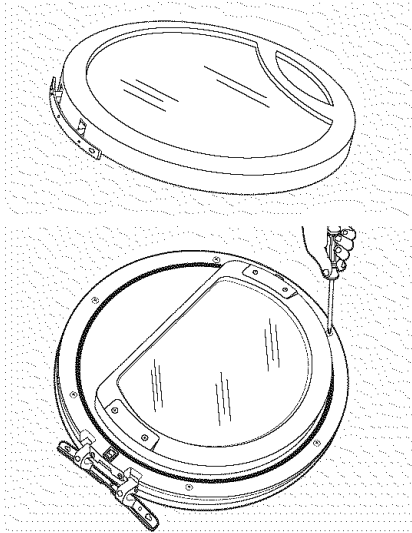

**19.** After reversing door, there will be a mismatch between the outer door and the inner door.

Make sure that the handle part of the outer door is opposite the hinge, as shown.

**20.** Turn the door over and fasten the outer door to the inner door using the 6 large tapping screws (#10).

#### Move Strike Bracket

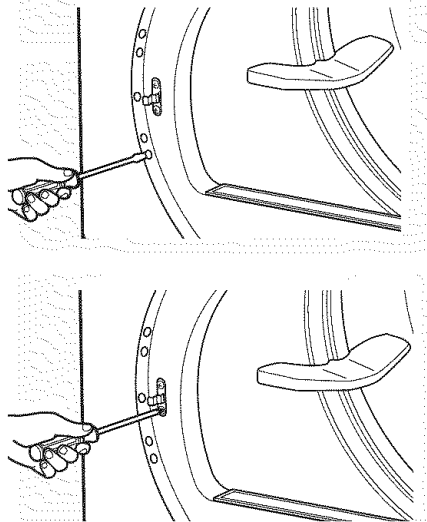

**21.** Using a putty knife or any other flat tool, remove the 5 plastic screw caps located on the dryer where the door will be installed and install them on the opposite side.

**22.** Switch the strike bracket and its cover on the opposite side by removing the screws; then reinstall both on the opposite side.

#### Reinstall Door Assembly

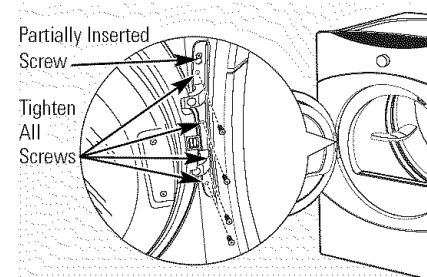

**23.** The door is now ready to be installed on the dryer. To ease this step, the hinge has keyholes that allow a partially fastened screw to be used as a hook.

Partially fasten a screw to the uppermost screw hole. Hook the door on the partially fastened screw.

Fasten the hinge by installing the other 4 screws and tightening the partially fastened screw above.



# Loading and using the dryer.

Always follow the fabric manufacturer's care label when laundering.



## Fabric Care Labels

Below are fabric care label "symbols" that affect the clothing you will be laundering.

### WASH LABELS

Machine wash cycle						
	Normal	Permanent Press/ wrinkle resistant	Gentle/ delicate	Hand wash	Do not wash	Do not wring
Front load target water temperature	<b>Category</b>		<b>Target Water Temperature</b>		<b>Automatic Temperature Control</b>	
	Tap Cold		Inlet Water Temperature		Not used	
	Cold		27°C/80°F		Used	
	Warm		40°C/105°F		Used	
	Hot		50°C/120°F		Used	
	Sanitize		70°C/160°F		Used	

### DRY LABELS

Tumble dry								
	Dry	Normal	Permanent Press/ wrinkle resistant	Gentle/ delicate	Do not tumble dry	Do not dry (used with do not wash)		
	Heat setting							
		High	Medium	Low	No heat/air			
		Special instructions						
			Line dry/ hang to dry	Drip dry	Dry flat	In the shade		

### BLEACH LABELS

Bleach symbols			
	Any bleach (when needed)	Only non-chlorine bleach (when needed)	Do not bleach



## Sorting and Loading Hints

As a general rule, if clothes are sorted properly for the washer, they are sorted properly for the dryer. Try also to sort items according to size. For example, do not dry a sheet with socks or other small items.

Do not add fabric softener sheets once the load has become warm. They may cause fabric softener stains. Bounce® Fabric Conditioner Dryer Sheets have been approved for use in all GE Dryers when used in accordance with the manufacturer's instructions.

**Do not overload.** This wastes energy and causes wrinkling.

**Do not dry the following items:** fiberglass items, woolens, rubber-coated items, plastics, items with plastic trim and foam-filled items.

## Loading and using the dryer.

Always follow the fabric manufacturer's care label when laundering.



### Care and Cleaning of the Dryer

**The Exterior:** Wipe or dust any spills or washing compounds with a damp cloth. Dryer control panel and finishes may be damaged by some laundry pretreatment soil and stain remover products. Apply these products away from the dryer. The fabric may then be washed and dried normally. Damage to your dryer caused by these products is not covered by your warranty.

**The Lint Filter:** Clean the lint filter before each use.

Pull out the lint filter. Moisten your fingers and remove the captured lint. Once clean, slide the filter back into position. Have a qualified technician vacuum the lint from the dryer once a year.

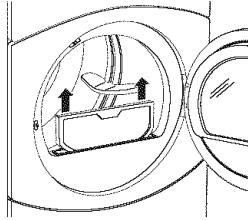

**NEVER OPERATE THE DRYER WITHOUT ITS FILTER IN PLACE.**

**The Exhaust Duct:** Inspect and clean the exhaust ducting at least once a year to prevent clogging. A partially clogged exhaust can lengthen the drying time.

Follow these steps:

- 1 Turn off electrical supply by disconnecting the plug from the wall socket.
- 2 Disconnect the duct from the dryer.
- 3 Vacuum the duct with the hose attachment and reconnect the duct.

**The Exhaust Hood:** Check with a mirror that the inside flaps of the hood move freely when operating. Make sure that there is no wildlife (birds, insects, etc.) nesting inside the duct or hood.

For the best drying performance, the dryer needs to be properly vented. **The dryer will use more energy and run longer if it is not vented to the below specifications. Carefully follow the details on Exhausting in the Installation Instructions.**

- Use only rigid metal or flexible metal 4" diameter ductwork inside the dryer cabinet or for exhausting to the outside.
- Do not use plastic or other combustible ductwork.
- Use the shortest length possible.
- Do not crush, kink or collapse the duct.
- Avoid resting the duct on sharp objects.
- **Venting must conform to local building codes.**
- Do not remove the vent protector from the back of the dryer.
- Flip the protector down to its lowest position and connect the exhaust duct to the dryer. The lowered protector will prevent the duct from getting crushed.

**Correct Venting**

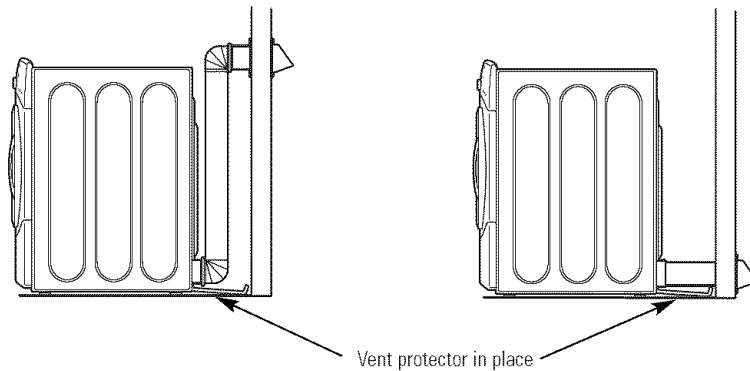

**Incorrect Venting**

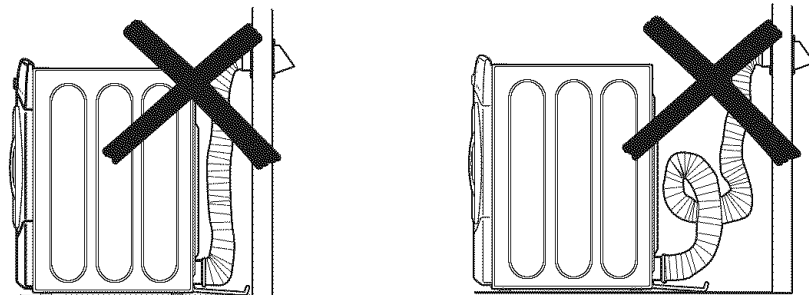

## Stacking.

### BEFORE YOU BEGIN

*Read these instructions completely and carefully.*

- **IMPORTANT:** Save these instructions for local electrical inspector's use.
- **IMPORTANT:** Observe all governing codes and ordinances.
- **Note to Installer** – Be sure to leave these instructions with the Consumer.
- **Note to Consumer** – Keep these instructions for future reference.
- Installation **must** be performed by a qualified installer.
- Proper installation is the responsibility of the installer.

### FOR YOUR SAFETY

#### **⚠ WARNING!**

- Electric Shock Hazard. Disconnect power before installing. Failure to do so could result in serious injury or death.
- **Potential Personal Injury. More than two people are recommended to lift the dryer into position because of its weight and size. Failure to do so could result in personal injury or death.**
- Avoid Tipping and Rupture of Utility Services. Dryer must be securely attached to the washer. **DO NOT** place the washer on top of the dryer. Failure to do so could result in personal injury/death or property damage.
- Mobile Home or Manufactured Home Installation – Stacking of a gas dryer is not permitted in a mobile home or manufactured home.

### MINIMUM CLEARANCE OTHER THAN ALCOVE OR CLOSET INSTALLATION

Minimum clearance to combustible surfaces and for air opening are: 0" both sides and 1" rear. Consideration must be given to provide adequate clearance for installation and service.

### ALCOVE OR CLOSET INSTALLATION

- If your dryer is approved for installation in an alcove or closet, it will be stated on a label on the dryer back.
- The dryer **MUST** be vented to the outdoors. Refer to dryer Installation Instructions for details.
- Minimum clearance between dryer cabinet and adjacent walls or other surfaces is:  
0" either side  
3" front and rear
- Minimum vertical space from floor to overhead cabinets, ceiling, etc. is 43" without pedestal, 55" with pedestal and 84" stacked.
- Closet doors must be louvered or otherwise ventilated and must contain a minimum of 60 square inches of open area equally distributed. If the closet contains both a washer and a dryer, doors must contain a minimum of 120 square inches of open area equally distributed.

# KIT CONTENTS

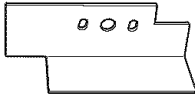

Right Hand Bracket

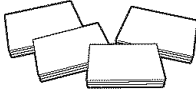

4 Rubber Pads



4 #12 x 1" Screws

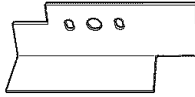

Left Hand Bracket



4 #8 x 1/2" Screws

# TOOLS YOU WILL NEED

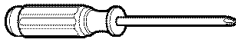

Phillips Screwdriver

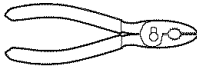

Pliers



Gloves

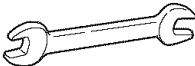

Open-Ended Wrench



Level

# INSTALLATION PREPARATION

Remove the packaging.  
Flatten the product carton to use as a pad to lay the dryer down on its side. Continue using the carton to protect the finished floor in front of the installation location.

## Stacking.

### INSTALLING THE STACK BRACKET KIT

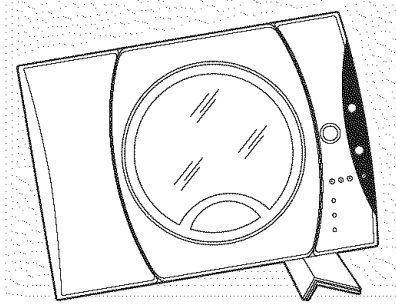

#### 1. Remove the Dryer Leveling Legs

- A. Carefully lay the dryer on its side. Use the packing material so you don't scratch the finish on the dryer.
- B. Use an open-end wrench or pliers to remove the dryer leveling legs.

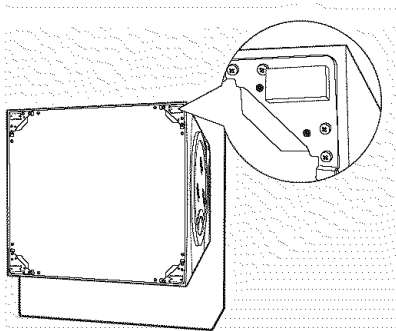
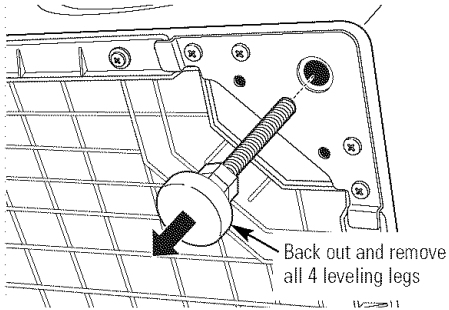

#### 2. Install Rubber Pads to Dryer Base

Locate the 4 rubber pads in the parts package. Remove the adhesive backing and firmly place over on the bracket where you removed the leveling legs.

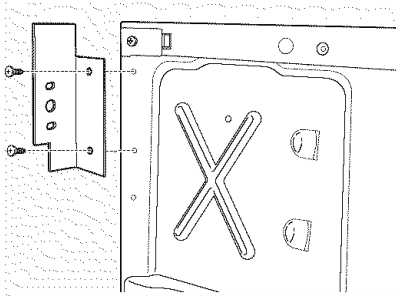

#### 3. Install Bracket to Dryer

- A. Align the holes in the left bracket with the holes in the bottom left corner of the dryer. Use a Phillips screwdriver to install the 2 #12 x 1" tapping screws.
- B. Repeat the above step with the right bracket on the bottom right corner of the dryer.
- C. Set the dryer upright.

**NOTE:** Make sure to set the dryer on a piece of packing material so the brackets that are attached to the bottom of the dryer do not damage the floor.

## INSTALLING THE STACK BRACKET KIT (cont.)

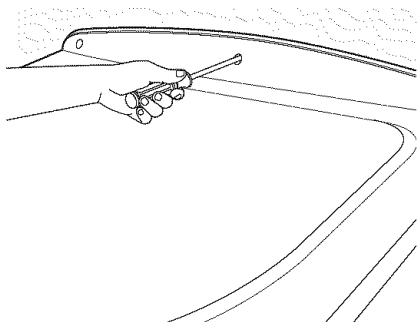

### 4. Prepare the Washer and Dryer

- A. Place the washer in the approximate location.
- B. Make sure the washer is level. Refer to washer Installation Instructions for details.
- C. Remove the back portion of the control panel by removing the 3 screws.

- D. Reverse dryer door swing if desired. See dryer installation instructions for details.

**NOTE:** The washer door swing is not reversible.

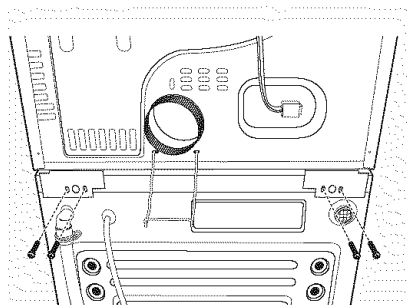

### 5. Install Dryer and Bracket on Washer

- A. Lift the dryer on top of the washer. Be careful not to scratch the top of the washer with the brackets. Protect the washer control panel with cardboard or other protection. Be sure to lift the dryer high enough to clear the washer control panel.

- B. Align the holes in the bracket with the holes in the back of the washer. Using a Phillips screwdriver attach the 2 #8 x 1/2" tapping screws. Repeat on both sides of the washer.

## **⚠ WARNING!**

**Potential Personal Injury. More than two people are recommended to lift the dryer into position because of its weight and size. Failure to do so could result in personal injury or death.**

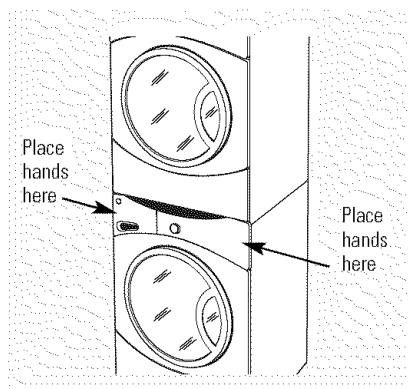

### 6. Finalize the Installation

- A. Refer to the washer Installation Instructions to complete the washer installation.
- B. Refer to the dryer Installation Instructions to complete the dryer installation.
- C. Carefully slide or walk the stacked washer and dryer into place. Use felt pads or other sliding device to assist moving and to protect flooring.

## **⚠ WARNING!**

**Potential Personal Injury. Do not push on the dryer once installed to top of the washer. Pushing on the dryer may result in pinched fingers.**

## Before you call for service...



**Troubleshooting Tips**  
Save time and money! Review the charts on the following pages, or visit [ge.com](http://ge.com). You may not need to call for service.

<b>OPERATION</b>	<b>Possible Causes</b>	<b>What To Do</b>
<b>Control pads not responding</b>	Controls accidentally put in service mode	<ul style="list-style-type: none"> <li>• Press <b>STOP</b>.</li> </ul>
	Controls accidentally put in lock mode	<ul style="list-style-type: none"> <li>• Hold the <b>LOCK</b> button for 3 seconds to unlock the dryer.</li> </ul>
	Controls performed an incorrect operation	<ul style="list-style-type: none"> <li>• Reset the in-house breaker.</li> </ul>
<b>Dryer doesn't start</b>	Control panel is "asleep"	<ul style="list-style-type: none"> <li>• This is normal. Press <b>POWER</b> to activate the control panel.</li> </ul>
	Dryer is unplugged	<ul style="list-style-type: none"> <li>• Make sure the dryer plug is pushed completely into the outlet.</li> </ul>
	Fuse is blown/circuit breaker is tripped	<ul style="list-style-type: none"> <li>• Check the building's fuse/circuit breaker box and replace fuse or reset breaker. <b>NOTE:</b> Electric dryers use two fuses or breakers.</li> </ul>
<b>Dryer doesn't heat</b>	Dryer was accidentally paused when starting Delay Start	<ul style="list-style-type: none"> <li>• If the light on the <b>DELAY START</b> pad is flashing, the dryer is paused. Press <b>START</b> to restart the countdown.</li> </ul>
	Fuse is blown/circuit breaker is tripped; the dryer may tumble but not heat	<ul style="list-style-type: none"> <li>• Check the building's fuse/circuit breaker box and replace both fuses or reset both breakers. Your dryer may tumble if only one fuse is blown or one breaker tripped.</li> </ul>
	Gas service is off	<ul style="list-style-type: none"> <li>• Make sure gas shutoff at dryer and main shutoff are fully open.</li> </ul>
<b>Dryer shakes or makes noise</b>	LP gas supply tank is empty or there has been a utility interruption of natural gas (gas models)	<ul style="list-style-type: none"> <li>• Refill or replace tank. Dryer should heat when utility service is restored.</li> </ul>
	Some shaking/noise is normal. Dryer may be sitting unevenly	<ul style="list-style-type: none"> <li>• Move dryer to an even floor space, or adjust leveling legs as necessary until even.</li> </ul>
<b>Inconsistent drying times</b>	Type of heat	<ul style="list-style-type: none"> <li>• Drying time will vary according to the type of heat used. If you recently changed from an electric to a gas (natural or LP) dryer, or vice versa, the drying time could be different.</li> </ul>
	Type of load and drying conditions	<ul style="list-style-type: none"> <li>• The load size, types of fabric, wetness of clothes and the length and condition of the exhaust system will affect drying times.</li> </ul>
<b>No numbers displayed during cycle, only lights</b>	Dryer is continuously monitoring the amount of moisture in the clothes	<ul style="list-style-type: none"> <li>• This is normal. When the dryer senses a low level of moisture in the load, the dryer will display the dry time remaining.</li> </ul>
<b>Time Remaining jumped to a lower number</b>	The estimated time may change when a smaller load than usual is drying	<ul style="list-style-type: none"> <li>• This is normal.</li> </ul>
<b>Glow at the rear of the drum</b>	Heaters behind the drum	<ul style="list-style-type: none"> <li>• This is normal. Under certain drying conditions and room ambient lighting, the glow of the heaters may be visible at the rear of the drum.</li> </ul>



<b>OPERATION</b>	<b>Possible Causes</b>	<b>What To Do</b>
<b>Clothes are still wet and dryer shut off after a short time</b>	The door was opened mid-cycle. The load was then removed from the dryer and a new load put in without selecting a new cycle	• A dry cycle must be reselected each time a new load is put in.
	Small load	• When drying 3 items or less, choose <b>SPEED DRY</b> or <b>TIMED DRY</b> .
	Load was already dry except for collars and waistbands	• Choose <b>SPEED DRY</b> or <b>TIMED DRY</b> to dry damp collars and waistbands. In the future, when drying a load with collars and waistbands, choose <b>MORE DRY</b> .
	Dryer is not level	• Move dryer to an even floor space or adjust leveling legs as necessary until even.
<b>The DRY dryness level was chosen but load is still damp</b>	Load consists of a mixture of heavy and light fabrics	• When combining heavy and light fabrics in a load, choose <b>MORE DRY</b> .
	Exhaust system is blocked	• Inspect and clean exhaust system.
<b>Cannot make a selection and the dryer beeps twice</b>	The <b>DRYNESS LEVEL</b> , <b>TEMP</b> or <b>OPTION</b> that you are trying to select is incompatible with the chosen dry cycle	• This is normal.
<b>Dryer is running but 00 is displayed in Time Remaining</b>	The <b>EXTEND TUMBLE</b> option was chosen	• This is normal. During extended tumbling, the time remaining is not displayed. The extended tumbling option lasts approximately 20 minutes.
<b>LAUNDRY PRACTICES</b>	<b>Possible Causes</b>	<b>What To Do</b>
<b>Clothes take too long to dry</b>	Improper or obstructed ducting	• Check the Installation Instructions to make sure the dryer venting is correct. • Make sure ducting is clean, free of kinks and unobstructed. • Check to see if outside wall damper operates easily.
	Improper sorting	• Separate heavy items from lightweight items (generally, a well-sorted washer load is a well-sorted dryer load).
	Large loads of heavy fabrics (like beach towels)	• Large, heavy fabrics contain more moisture and take longer to dry. Separate large, heavy fabrics into smaller loads to speed drying time.
	Controls improperly set	• Match control settings to the load you are drying.
	Lint filter is full	• Clean lint filter before every load.
	Blown fuses or tripped circuit breaker	• Replace fuses or reset circuit breakers. Since most dryers use 2 fuses/breakers, make sure both are operating.
	Overloading/combining loads	• Do not put more than one washer load in the dryer at a time.
	Underloading	• If you are drying only one or two items, add a few items to ensure proper tumbling.

## Before you call for service...

<b>LAUNDRY PRACTICES</b>	<b>Possible Causes</b>	<b>What To Do</b>
<b><i>Clothes are wrinkled</i></b>	Overdrying	<ul style="list-style-type: none"> <li>• Select a shorter drying time.</li> <li>• Remove items while they still hold a slight amount of moisture. Select a <b>LESS DRY</b> or <b>DAMP</b> setting.</li> </ul>
	Letting items sit in dryer after cycle ends	<ul style="list-style-type: none"> <li>• Remove items when cycle ends and fold or hang immediately, or use the <b>EXTEND TUMBLE</b> option.</li> </ul>
	Overloading	<ul style="list-style-type: none"> <li>• Separate large loads into smaller ones.</li> </ul>
<b><i>Clothes shrink</i></b>	Some fabrics will naturally shrink when washed. Others can be safely washed, but will shrink in the dryer	<ul style="list-style-type: none"> <li>• To avoid shrinkage, follow garment care labels exactly.</li> <li>• Some items may be pressed back into shape after drying.</li> <li>• If you are concerned about shrinkage in a particular item, do not machine wash or tumble dry it.</li> </ul>
<b><i>Greasy spots on clothes</i></b>	Improper use of fabric softener	<ul style="list-style-type: none"> <li>• Follow directions on fabric softener package.</li> </ul>
	Drying dirty items with clean ones	<ul style="list-style-type: none"> <li>• Use your dryer to dry only clean items. Dirty items can stain clean items and the dryer.</li> </ul>
	Clothes were not completely clean	<ul style="list-style-type: none"> <li>• Sometimes stains which cannot be seen when the clothes are wet <i>appear</i> after drying. Use proper washing procedures before drying.</li> </ul>
<b><i>Lint on clothes</i></b>	Lint filter is full	<ul style="list-style-type: none"> <li>• Clean lint screen before each load.</li> </ul>
	Improper sorting	<ul style="list-style-type: none"> <li>• Sort lint producers (like chenille) from lint collectors (like corduroy).</li> </ul>
	Static electricity can attract lint	<ul style="list-style-type: none"> <li>• See suggestions in this section under <b>STATIC</b>.</li> </ul>
	Overloading	<ul style="list-style-type: none"> <li>• Separate large loads into smaller ones.</li> </ul>
	Paper, tissue, etc., left in pockets	<ul style="list-style-type: none"> <li>• Empty all pockets before laundering clothes.</li> </ul>
<b><i>Static occurs</i></b>	No fabric softener was used	<ul style="list-style-type: none"> <li>• Try a fabric softener.</li> <li>• Bounce® Fabric Conditioner Dryer Sheets have been approved for use in all GE Dryers when used in accordance with the manufacturer's instructions.</li> </ul>
	Overdrying	<ul style="list-style-type: none"> <li>• Try a fabric softener.</li> <li>• Adjust setting to <b>LESS DRY</b> or <b>DAMP</b>.</li> </ul>
	Synthetics, permanent press and blends can cause static	<ul style="list-style-type: none"> <li>• Try a fabric softener.</li> </ul>
<b><i>Collars and waistbands still wet at end of cycle</i></b>	The dryness monitor senses that the body of the clothes is dry	<ul style="list-style-type: none"> <li>• Choose <b>SPEED DRY</b> or <b>TIMED DRY</b> to dry damp collars and waistbands. In the future, when drying a load with collars and waistbands, choose <b>MORE DRY</b>.</li> </ul>

# GE Dryer Warranty.



All warranty service provided by our Factory Service Centers, or an authorized Customer Care® technician. To schedule service, on-line, 24 hours a day, visit us at [ge.com](http://ge.com), or call 800.GE.CARES (800.432.2737).

Please have serial number and model number available when calling for service.

Staple your receipt here.  
Proof of the original purchase date is needed to obtain service under the warranty.

## For The Period Of: We Will Replace:

**One Year**  
From the date of the original purchase

**Any part** of the dryer which fails due to a defect in materials or workmanship. During this **limited one-year warranty**, GE will also provide, **free of charge**, all labor and related service costs to replace the defective part.

## What Is Not Covered:

- Service trips to your home to teach you how to use the product.
- Improper installation, delivery or maintenance.
- Failure of the product if it is abused, misused or used for other than the intended purpose or used commercially.
- Replacement of house fuses or resetting of circuit breakers.
- Damage to the product caused by accident, fire, floods or acts of God.
- Incidental or consequential damage caused by possible defects with this appliance.
- Damage caused after delivery.
- Product not accessible to provide required service.

**EXCLUSION OF IMPLIED WARRANTIES—Your sole and exclusive remedy is product repair as provided in this Limited Warranty. Any implied warranties, including the implied warranties of merchantability or fitness for a particular purpose, are limited to one year or the shortest period allowed by law.**

This warranty is extended to the original purchaser and any succeeding owner for products purchased for home use within the USA. If the product is located in an area where service by a GE Authorized Servicer is not available, you may be responsible for a trip charge or you may be required to bring the product to an Authorized GE Service location for service. In Alaska, the warranty excludes the cost of shipping or service calls to your home.

Some states do not allow the exclusion or limitation of incidental or consequential damages. This warranty gives you specific legal rights, and you may also have other rights which vary from state to state. To know what your legal rights are, consult your local or state consumer affairs office or your state's Attorney General.

**Warrantor: General Electric Company. Louisville, KY 40225**

## Consumer Support.

---



### *GE Appliances Website*

**ge.com**

Have a question or need assistance with your appliance? Try the GE Appliances Website 24 hours a day, any day of the year! For greater convenience and faster service, you can now download Owner's Manuals, order parts or even schedule service on-line.

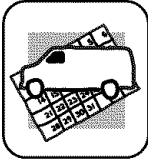

### *Schedule Service*

**ge.com**

Expert GE repair service is only one step away from your door. Get on-line and schedule your service at your convenience 24 hours any day of the year! Or call 800.GE.CARES (800.432.2737) during normal business hours.

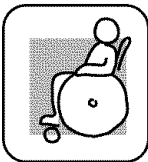

### *Real Life Design Studio*

**ge.com**

GE supports the Universal Design concept—products, services and environments that can be used by people of all ages, sizes and capabilities. We recognize the need to design for a wide range of physical and mental abilities and impairments. For details of GE's Universal Design applications, including kitchen design ideas for people with disabilities, check out our Website today. For the hearing impaired, please call 800.TDD.GEAC (800.833.4322).



### *Extended Warranties*

**ge.com**

Purchase a GE extended warranty and learn about special discounts that are available while your warranty is still in effect. You can purchase it on-line anytime, or call 800.626.2224 during normal business hours. GE Consumer Home Services will still be there after your warranty expires.

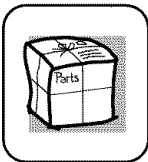

### *Parts and Accessories*

**ge.com**

Individuals qualified to service their own appliances can have parts or accessories sent directly to their homes (VISA, MasterCard and Discover cards are accepted). Order on-line today, 24 hours every day or by phone at 800.626.2002 during normal business hours.

***Instructions contained in this manual cover procedures to be performed by any user. Other servicing generally should be referred to qualified service personnel. Caution must be exercised, since improper servicing may cause unsafe operation.***



### *Contact Us*

**ge.com**

If you are not satisfied with the service you receive from GE, contact us on our Website with all the details including your phone number, or write to: General Manager, Customer Relations  
GE Appliances, Appliance Park  
Louisville, KY 40225



### *Register Your Appliance*

**ge.com**

Register your new appliance on-line—at your convenience! Timely product registration will allow for enhanced communication and prompt service under the terms of your warranty, should the need arise. You may also mail in the pre-printed registration card included in the packing material.