



ENGLISH

ESPAÑOL

OWNER'S MANUAL

ELECTRIC CONVECTION BUILT-IN OVEN

Please read this guide thoroughly before operating and keep it handy for reference at all times.

LWS3010ST

INTRODUCTION

IMPORTANT SAFETY INFORMATION

Safety Precautions	3-4
Electrical Safety.....	4
Safety During Use	5
Child Safety	5
Safety When Cleaning.....	6

PARTS AND FEATURES

Parts And Features.....	7
Control Panel Features	8

OPERATING INSTRUCTIONS

Clock.....	10
Minimum & Maximum Default Settings.....	10
Timer On/Off.....	11
Special Features of your Oven Control	12-13
Bake	14
Baking layer cakes	15
Timed Cook	16
Delayed Timed Cook	17
Broil	18
Recommended Broiling guide	18-19
Roast	20
Convection Bake	21
Crisp Convection	22
Convection Roast	23
Warm	24
Proof.....	25
To Turn on/off the oven light	25
Control Lock Feature.....	26
Favorite.....	26
Self Clean	27-29

MAINTENANCE

Care & Cleaning	30-31
Removing & Replacing the Lift-Off Oven Door.....	32
Door Care Instructions.....	32

TROUBLESHOOTING

Before Calling for Service	33-35
----------------------------------	-------

WARRANTY

Warranty for customers in the U.S.A.....	36
--	----

THANK YOU!

Congratulations on your purchase and welcome to the LG family. Your new LG Built-In Oven combines precision cooking features with simple operation and stylish design. Follow the operating and care instructions in this manual and your oven will provide you with many years of reliable service.

Product Registration Information

Model: _____

Serial Number: _____

Date of Purchase: _____

IMPORTANT SAFETY INFORMATION

READ ALL INSTRUCTIONS BEFORE USE



This is the safety alert symbol. This symbol alerts you to potential hazards that can kill or hurt you and others. All safety messages will follow the safety alert symbol and either the word **WARNING** or **CAUTION**. These words mean:

! WARNING This symbol will alert you to hazards or unsafe practices which could cause serious bodily harm or death.

! CAUTION This symbol will alert you to hazards or unsafe practices which could cause bodily injury or property damage.

SAFETY PRECAUTIONS

- Be certain your appliance is properly installed and grounded by a qualified technician.
- Do not repair or replace any part of the appliance unless specifically recommended in the manual.
- All other servicing should be referred to a qualified technician.
- Always disconnect power to appliance before servicing by unplugging, removing the fuse or switching off the circuit breaker.

• DO NOT TOUCH HEATING ELEMENTS OR INTERIOR SURFACES OF OVEN.

Heating elements may be hot even though they are dark in color. Interior surfaces of an oven become hot enough to cause burns. During and after use, do not touch or let clothing or other flammable materials contact heating elements or interior surfaces of oven until they have had sufficient time to cool. Other surfaces of the appliance may become hot enough to cause burns. Among these surfaces are oven vent openings and surfaces near these openings, oven doors, and windows of oven doors.

- **Use Care When Opening Door.**
Let hot air or steam escape before you remove or replace food in the oven
- **Do Not Heat Unopened Food Containers.**
Build-up of pressure may cause container to burst and result in injury.

• Keep Oven Vent Ducts Unobstructed.

The oven vent could become hot during oven use. Never block this vent and never place plastic or heat-sensitive items on or near the vent.

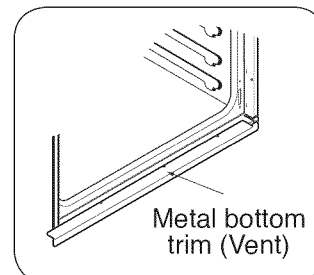

NOTE:

For proper operation vent trim must be installed.

! WARNING

- **NEVER use your appliance for warming or heating the room.**
- **DO NOT use water on grease fires.**
Should an oven fire occur, leave the oven door closed and turn the oven off. If the fire continues, throw baking soda on the fire or use a fire extinguisher.
- **Use dry pot holders only.**
Moist or damp pot holders on hot surfaces may result in burns from steam. Do not let the pot holder touch hot heating elements. Do not use a towel or other bulky cloth.
- **Storage in or on appliance.**
Flammable materials should not be stored in an oven or near surface elements.
- **Wear proper apparel.**
Loose-fitting or hanging garments should never be worn while using the appliance.

IMPORTANT SAFETY INFORMATION

READ ALL INSTRUCTIONS BEFORE USE

SAFETY PRECAUTIONS (cont.)

- **Be certain all packing materials are removed from the appliance before operating.**
Keep plastics, clothes, and paper away from parts of the appliance that may become hot.
- **DO NOT force the door open.**
This can damage the automatic door locking system. Use care when opening the oven door after the self-cleaning cycle. Stand to the side of the oven when opening the door to allow hot air or steam to escape. The oven may still be VERY HOT.
- **DO NOT use a steel-wool pad.**
It will SCRATCH the surface.
- **DO NOT use harsh etching, abrasive cleaners or sharp metal scrapers to clean the oven door glass since they can scratch the surface.**
It may result in shattering of the glass.
- **Be careful when removing and lifting the door.**
- **DO NOT lift the door by the handle.**
The door is very heavy.
- **DO NOT step or sit on oven door.**
Be sure to follow proper installation instructions.

ELECTRICAL SAFETY

- **Protective Liners.** Do not use aluminum foil or any other material to line the oven bottoms. Improper installation of these liners may result in a risk of electric shock or fire.
- **Do Not** allow aluminum foil or meat probe to contact heating elements.
- **Before replacing your oven light bulb, switch off the electrical power to the oven at the main fuse or circuit breaker panel.**
Failure to do so can result in severe personal injury, death, or electrical shock.
- **DO NOT line the oven walls, racks, bottom, or any other part of the oven with aluminum foil or any other material.**
Doing so will disrupt heat distribution, produce poor baking results and cause permanent damage to the oven interior (aluminum foil will melt to the interior surface of the oven.)

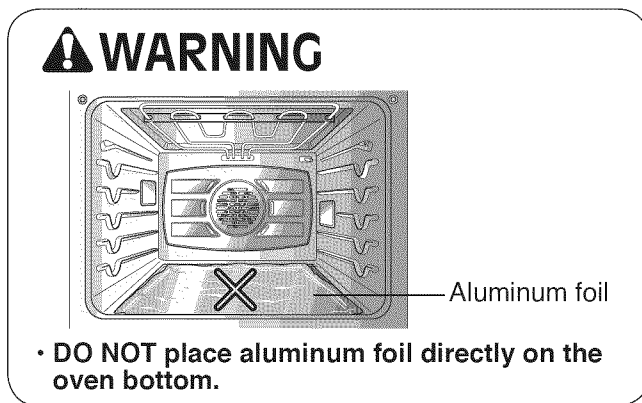

IMPORTANT SAFETY INFORMATION

READ ALL INSTRUCTIONS BEFORE USE

SAFETY DURING USE

- **Oven Racks.** Always place oven racks in desired position while oven is cool.
- **Always use pot holders or oven mitts when removing food from the oven.**
You can be burned because cookware and plates will be hot.
- **Use caution with the TIMED BAKE or DELAYED TIMED BAKE features.** Use the automatic timer when cooking cured or frozen meats and most fruits and vegetables. Foods that can easily spoil, such as milk, eggs, fish, meat or poultry, should be chilled in the refrigerator first. Even when chilled, they should not stand in the oven for more than 1 hour before cooking begins, and should be removed promptly when cooking is completed.
Eating spoiled food can result in sickness from food poisoning.
- **Should an oven fire occur, leave the oven door closed and turn the oven off. If the fire continues, throw baking soda on the fire or use a fire extinguisher.**
- **DO NOT put water or flour on the fire.**
Flour may be explosive and water can cause a grease fire to spread and cause personal injury.
- **DO NOT use the broiler pan without the grid. DO NOT cover the grid with aluminum foil.**

CHILD SAFETY

WARNING

- Children should be kept away from the oven.
- **Accessory parts will become hot when the broiler is in use.**

CAUTION

- **DO NOT leave small children unattended near the appliance.**
During the self-cleaning cycle, the outside of the oven can become very hot to the touch.

CAUTION

- Children should not be left alone or unattended in area where appliance is in use. Children should never be allowed to sit or stand on any part of the appliance.

IMPORTANT SAFETY INFORMATION

READ ALL INSTRUCTIONS BEFORE USE

SAFETY WHEN CLEANING

- **Do Not Clean Door Gasket.** The door gasket is essential for a good seal. Care should be taken not to rub, damage, or move the gasket.
- **Do Not Use Oven Cleaners.** No commercial oven cleaner or oven liner protective coating of any kind should be used in or around any part of the oven.
- **Before self cleaning the oven.** Remove broiler pan, all oven racks, meat probe and any other utensils from the oven cavity.
- **Never keep pet birds in the kitchen.** The health of birds is extremely sensitive to the fumes released during an oven self-clean cycle. Fumes may be harmful or fatal to birds. Move birds to well-ventilated room.
- **Important Instruction.** In the event the self clean error code F is displayed, and error melody sounds, the oven is malfunctioning in the self clean mode. Switch off the electrical power to the main fuse or breaker and have serviced by a qualified technician.
- **Make sure oven lights are cool before cleaning.**
- **DO NOT block the oven vent during operation.** This can damage the electric parts of the oven. Air must be able to move freely. The metal bottom trim (vent) should be properly assembled on the front bottom of oven before installing the oven door.

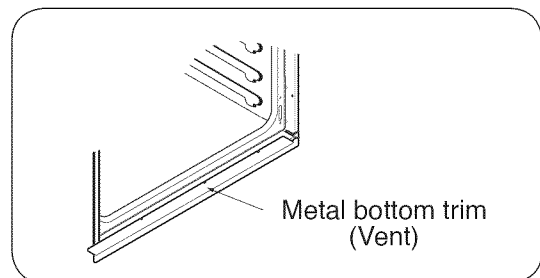

PARTS AND FEATURES

PARTS AND FEATURES

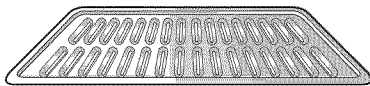
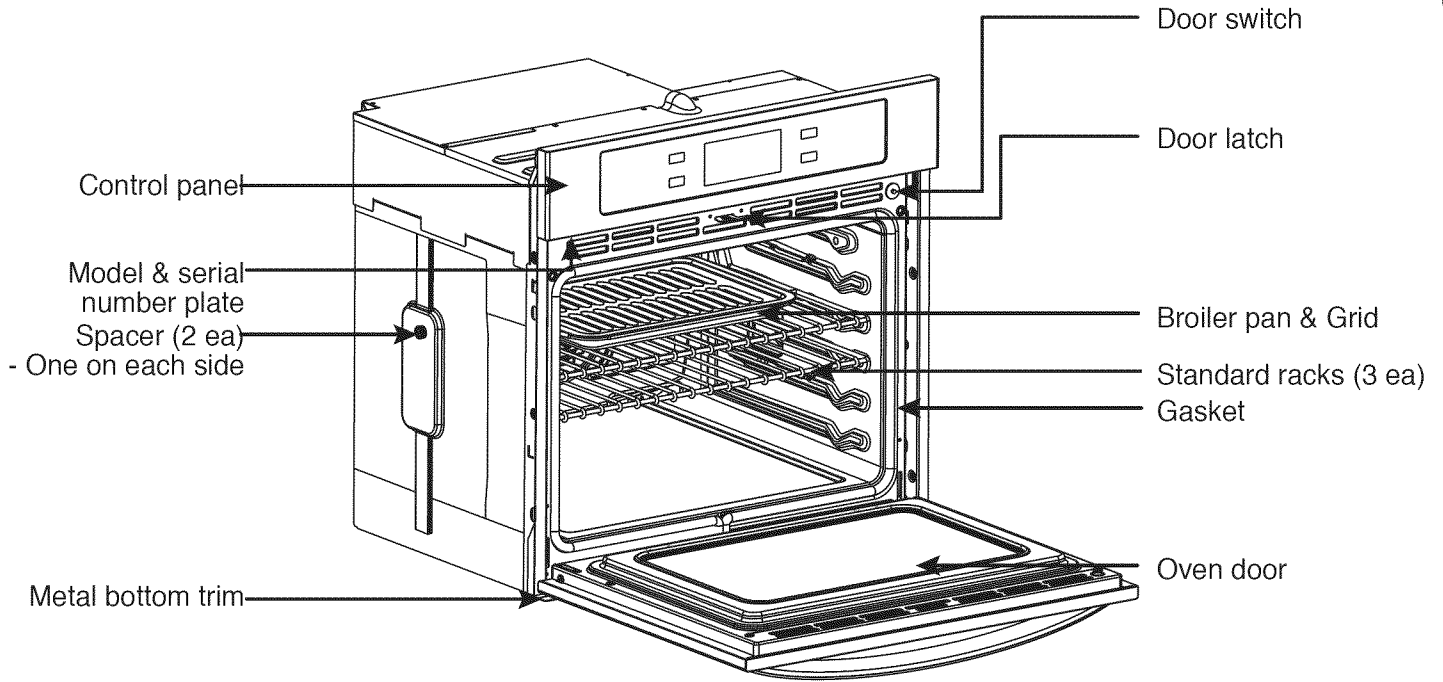

Grid

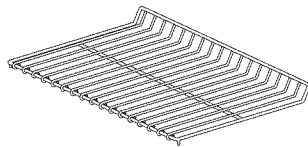

Standard racks (3 ea)



6 Screws For
Bottom Trim
(3 needed for installation
and 3 extras)

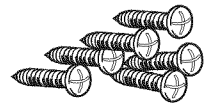

6 Wood Screws
For Mounting
(4 needed for installation
and 2 extras)

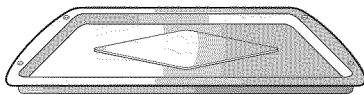

Broiler pan



30" (76.2 cm)
Metal Bottom Trim (1 ea)

PARTS AND FEATURES

CONTROL PANEL FEATURES

READ THE INSTRUCTIONS CAREFULLY BEFORE USING THE OVEN. For satisfactory use of your oven, become familiar with the various features and functions of the oven as described below. **Detailed instructions for each feature and function are listed in this Owner's Manual.**

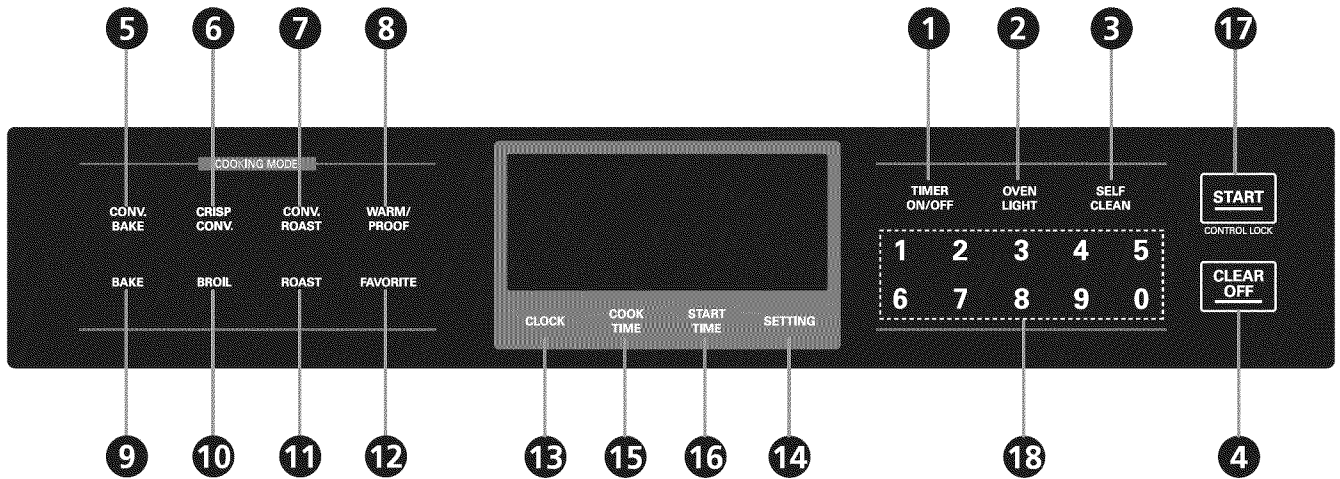

- 1** **TIMER ON/OFF** : Use to set or cancel the timer of the oven.
- 2** **OVEN LIGHT** : Use to turn the Oven lights of the oven on and off.
- 3** **SELF CLEAN** : Use to select the Self Clean of the oven.
- 4** **CLEAR OFF** : Use to stop cooking, cancel settings of the oven.
- 5** **CONV. BAKE** : Use to select the Conv. bake function of the oven.
- 6** **CRISP CONV.** : Use to select the Crisp convection function of the oven.
- 7** **CONV. ROAST** : Use to select the Conv. roast function of the oven.
- 8** **WARM/PROOF** : Use to select the Warm/Proof function of the oven.
- 9** **BAKE** : Use to select the Bake function of the oven.
- 10** **BROIL** : Use to select the Broil function of the oven.
- 11** **ROAST** : Use to select the Roast function of the oven.
- 12** **FAVORITE** : Use to select the Favorite function of the oven.

CONTROL PANEL FEATURES (cont')

COMMON FUNCTION

- 13 **CLOCK** : Use to set the time of day.
- 14 **SETTING** : See page 12 and 13.
- 15 **COOK TIME** : Use to set the length of the cook time. (Bake, Conv. Bake/Roast only)
- 16 **START TIME** : Use to set delay time. (Bake, Conv. Bake/Roast, Self clean only)
- 17 **START** : Use to START all functions in the oven. To activate OVEN LOCK press and hold for 3 seconds.
- 18 **NUMBER PADS** : Use to enter a temperature and all times.

NOTE:

If F- and a number appear in the display and the oven control signals, this indicates a function error code.

See page 33.

Touch the **CLEAR OFF** pad. Allow the oven to cool for one hour. Put the oven back into operation.

If the function error code repeats, disconnect the power to the oven and call for service.

If your oven was set for a timed oven operation and a power outage occurred, the clock and all programmed functions must be reset.

The time of day will flash in the display when there has been a power outage.

OPERATING INSTRUCTIONS

CLOCK

How to set the Clock

The clock must be set to the correct time of day for the automatic oven timing functions to work properly. The time of day cannot be changed during a timed baking or Self Clean cycle.

CLOCK

- 1 Touch the **CLOCK** pad once to set.

1 2 3

- 2 Touch the **number** pad to enter the time. Touch the number pad with the correct time of day. For example, to set 12:34, touch the number pad **1, 2, 3** and **4**. If number pad is not touched within 30 seconds after you touch the **CLOCK** pad, the display reverts to the original setting. If this happens, touch the **CLOCK** pad and reenter the time of day.



- 3 Touch **START**. This enters the time and starts the clock.

To check the time of day when the display is showing other information, simply touch the **CLOCK** pad.

How to change hour mode on Clock (12HR or 24HR)

Your control is set to use a 24-hour clock. If you would prefer to have a 12-hour time clock, follow the steps below.

CLOCK

- 1 Touch the **CLOCK** pad for 3 seconds.

1
or
2

- 2 Touch the number **1** pad for 12-hour, **2** pad for 24-hour.



- 3 Touch the **START** pad to accept the desired change.

Power outage

If a flashing time is in the display, you have experienced a power failure. Reset the clock.

Touch the **CLOCK** pad once to reset. Enter the correct time of day by touching the appropriate number pads. Touch the **START** pad.

MINIMUM & MAXIMUM DEFAULT SETTINGS

All of the features listed have minimum and maximum time or temperature settings that may be entered into the control. An entry acceptance beep will sound each time a control pad is touched.

An entry error tone (2 short melody) will sound if the entry of the temperature or time is below the minimum or above the maximum settings for the feature.

Feature	Min. Temp. / Time	Max. Temp. / Time
BAKE / ROAST	170°F (80°C)	550°F (288°C)
BROIL [Full / Center]	LO (350°F)	HI (550°F)
CONVECTION BAKE/ CONVECTION ROAST/ CRISP CONVECTION	170°F (80°C)	550°F (288°C)
PROOF	100°F	
WARM	LO (140°F) / 3 hours	HI (200°F) / 3 hours
SELF CLEAN	2 hours	4 hours

TIMER ON/OFF

The **TIMER ON/OFF** serves as an extra timer in the kitchen that will beep when the set time has run out. It does not start or stop cooking.

The **TIMER ON/OFF** feature can be used during any of the other oven control functions.

To set the Timer (example to set 5 minutes):

**TIMER
ON/OFF**

- 1 Touch **TIMER ON/OFF** twice. **0:00** and **HR** inside will appear and **TIMER** will flash in the display.



5

- 2 Touch **5** in the number pad. You can see **0:05** in the display



**TIMER
ON/OFF**

- 3 Touch **TIMER to start the Timer**. The time will count down with 5:00 and the time will show in the display.



NOTE:

If **TIMER ON/OFF** is not touched, the timer will return to the time of day.

**TIMER
ON/OFF**

- 4 When the set time has run out, **End** will show in the display. The indicator tones will sound every 15 seconds until **TIMER ON/OFF** is touched.

NOTE:

If the remaining time is not in the display, recall the remaining time by touching the **TIMER ON/OFF**.

NOTE:

- If you touch **TIMER ON/OFF** once, it allows you to set the time in seconds.
(for example: if you touch 50, it means 50 seconds)



- If you touch **TIMER ON/OFF** twice, it allows you to set the time in minutes.
(for example: if you touch 5, it means 5 minutes)



To cancel the Timer before the set time has run out:

**TIMER
ON/OFF**

- 1 Touch **TIMER ON/OFF** once. The display will return to the time of day.

OPERATING INSTRUCTIONS (SET UP)

SPECIAL FEATURES OF YOUR OVEN CONTROL

Your new touch pad control has additional features that you may choose to use. The following pages describe these features and how you may activate them.

The special feature modes can only be activated while the display is showing the time of day.

They remain in the control's memory until the steps are repeated.

When the display shows your choice, touch the **START** pad. The special features will remain in memory after a power failure.

How to set convection auto conversion function

When using convection bake and roast, the Convection Auto Conversion feature will automatically convert entered regular baking temperatures to convection baking temperatures.

This feature is activated so that the display will show the actual converted (reduced) temperature. For example, if you enter a regular recipe temperature of 350°F and press the START function, the display will show the converted temperature of 325°F.

SETTING

- 1 Touch the **SETTING** pad once. "AUTO" will appear in the display.

1
or
2

- 2 Touch the # 1 pad to ENABLE or touch the # 2 pad to DISABLE.



- 3 Touch the **START** pad to accept the change.

How to adjust the oven thermostat

You may find that your new oven cooks differently than the one it replaced. Use your new oven for a few weeks to become more familiar with it. If you still think your new oven is too hot or too cold, you can adjust the thermostat yourself.

Do not use thermometers, such as those found in grocery stores, to check the temperature setting of your oven.

These thermometers may vary 20–40 degrees.

NOTE:

This adjustment will not affect the broiling or the Self Clean temperatures. The adjustment will be retained in memory after a power failure.

The oven temperature can be increased (+) or decreased (-) as much as 35°F or 19°C.

NOTE:

Once the temperature is increased or decreased, the display will show the adjusted temperature until it is readjusted.

NOTE:

The thermostat adjustment for Bake will also affect Convection Bake or Convection Roast.

To Adjust the Oven Temperature

SETTING

- 1 Touch **SETTING** pad 2 times for the lower oven, "AdJU" will appear in the display.

- 2 Using the number pad enter the temperature correction you wish to adjust. Example: to adjust the oven temperature UP 15 degrees, touch 15.



- 3 Touch **START** pad to accept the change.



- 4 To lower the oven temperature enter 15 then touch **SETTING** pad to DECREASE the temperature, (for - value).



- 5 Touch **START** pad to accept the change.

SPECIAL FEATURES OF YOUR OVEN CONTROL (cont')

How to select language

Your oven control is set to display in English but you may change this to display in Spanish or French.

SETTING

- 1 Touch the **SETTING** pad 3 times, "Lng" will appear in the display.

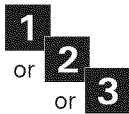

- 2 Touch the # 1 pad for English, touch the # 2 pad for Spanish, touch the # 3 pad for French.

- 3 Touch the **START** pad to accept the change.



How to adjust beeper volume

The beeper volume feature allows you to adjust the volumes to a more acceptable volume. There are four possible volume levels, loud, normal, low and mute.

SETTING

- 1 Touch the **SETTING** pad 4 times and "BEEP" will appear in the display.

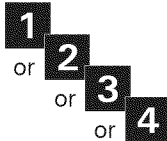

- 2 Touch the # 1 pad for LOUD, touch the # 2 pad for NORMAL, touch the # 3 pad for LOW, and touch the # 4 pad for MUTE.

- 3 Touch the **START** pad to accept the change.



How to select fahrenheit or Centigrade temperature

Your oven control is set to use the Fahrenheit temperature. This can be changed to Centigrade.

SETTING

- 1 Touch the **SETTING** pad 5 times and "UNIT" will appear in the display.



- 2 Touch the # 1 pad for F (Fahrenheit) or touch the # 2 pad for C (Centigrade).

- 3 Touch the **START** pad to accept the change.



OPERATING INSTRUCTIONS

BAKE

The oven can be programmed to bake at any temperature from 170°F (80°C) to 550°F (288°C). Default temperature is 350°F (177°C).

To set the oven to **BAKE** and temperature to 375°F



① Touch **BAKE**.



② Set the oven temperature (Touch **3**, **7** and **5**).



③ Touch **START**.

The word **PREHEATING** and **100°F** will be displayed. As the oven preheats the temperature is displayed in 5 degree increments. Once the oven reaches the desired temperature, a tone will sound.

PREHEATING

Place the food in the oven after preheating. Preheating is necessary for better cooking results.



④ When cooking is finished, touch **CLEAR OFF**.

⑤ Remove food from the oven.

Tips for baking

Follow the recipe or convection food directions for baking temperature, time and rack position. Baking time and temperature will vary depending on the ingredients, size, and shaped of the baking pan used.

- For best results, food should be baked. food on a single rack with at least 1" to 1 1/2" of air space between the pans and oven walls.
- Check for doneness at the minimum time.
- Use metal bakeware (with or without a nonstick finish), heatproof glass-ceramic, ceramic or other bakeware recommended for oven use.
- Dark metal pans or nonstick coatings will cook faster with more browning. Insulated bake ware will slightly lengthen the cooking time for most foods.

Displays of the **BAKE** mode

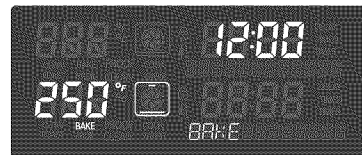

To change the Bake Temperature while cooking (example changing from 375°F to 425°F):



① Touch **BAKE**.



② Set the oven temperature (Touch **4**, **2** and **5**).



③ Touch **START**.

OPERATING INSTRUCTIONS

BAKING LAYER CAKES

Baking results will be better if baking pans are centered in the oven as much as possible. If baking with more than one pan, place the pans so each has at least 2" to 2-1/2" of air space around it. If cooking on multiple racks, place the oven racks in positions B and D (For 2 racks). Place the cookware as shown in Fig. 1, 2.

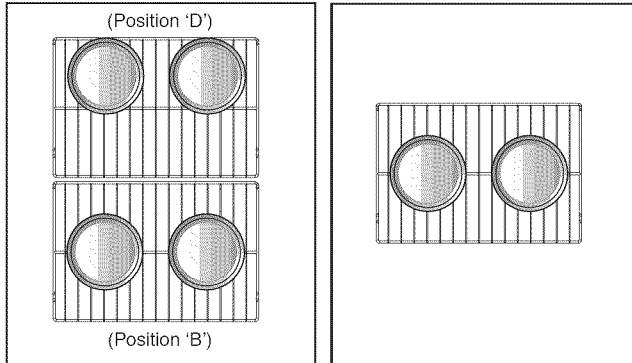
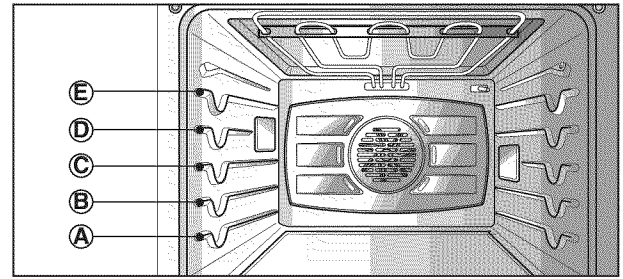

Figure 1

Figure 2

• The oven has 5 rack positions.

Type of Food	Rack Position
Angel food cake, Frozen pies	B
Bundt or pound cakes	B
Biscuits, Muffins, Brownies, Cookies, Cupcakes, Layer cakes, Pies	C
Casseroles	B
Turkey, Roast, or Ham	A

NOTE:

Preheating is necessary for good results when baking cakes, cookies, pastries and breads. After the oven has reached the desired temperature, the preheat melody will sound once.

The heating elements turn off immediately when the door is opened. They will turn on again in approximately 5 seconds after the door is closed. If you leave the oven door open for more than 30 minutes, all settings are canceled.

Touch **CLEAR OFF** to cancel BAKE at any time.

OPERATING INSTRUCTIONS

TIMED COOK

The oven will turn on immediately and cook for a selected length of time. At the end of the cooking time, the oven will turn off automatically.

To set the oven to begin cooking immediately and shut off automatically: (example to set bake at 300°F for 30 minutes.)

- 1 Be sure the clock is set for the correct time of day.



- 2 Touch **BAKE**, 350°F will appear in the display.



- 3 Set the oven temperature (Touch **3**, **0** and **0**).



- 4 Touch **COOK TIME**. **TIMED** will flash. **BAKE**, **0:00** and **300°F** will appear in the display.



- 5 Set the desired baking time (Touch **3** and **0**).

NOTE:

Baking time can be set for any amount of time between 1 minute to 11 hours and 59 minutes.



- 6 Touch **START**. The oven will turn on, and the display will show the cooking time countdown. The oven will continue to cook for the set amount of time, then turn off automatically, unless the **WARM** feature was set. Refer to the Setting the **WARM** feature section on page 24.



- 7 Touch **CLEAR OFF** to cancel this function at any time.

To change the cook time while operating the oven.

(example to change the cook time from 30 minutes to 1 hour 30 minutes.)



- 1 Touch **COOK TIME**.



- 2 Set the changed baking time (Touch **1**, **3** and **0**).



- 3 Touch **START** to accept the change or touch **CLEAR OFF** to reset the time you input.

When Timed Cook finishes:

- 1 **END OF CYCLE** and the time of day will show in the display. The oven will shut off automatically.



- 2 The control will continue to sound the cook end melody every minute until **CLEAR OFF** is touched.

NOTE:

- During the preheating mode, the convection fan operates constantly to circulate the hot air. The convection fan will turn off automatically after the preset temperature is attained.
- After any cooking cycle has been completed cooling fans will operate to protect the control panel. This is normal.

OPERATING INSTRUCTIONS

DELAYED TIMED COOK

The automatic timer of the Delayed Timed Cook will turn the oven ON and OFF at the time you select in advance

**To set the oven for a Delayed Start .
(example to set BAKE at 300°F for 30 minutes
and start operating the bake mode at 4:30pm)**

- 1 Be sure that the clock is set with the correct time of day.
- 2 Arrange interior oven rack(s) and place the food in the oven.
- 3 Touch **BAKE**. 350°F will appear in the display.

BAKE

3 0 0

- 4 Set the oven temperature (Touch **3**, **0** and **0**).

COOK TIME

- 5 Touch **COOK TIME**.

3 0

- 6 Set the desired baking time (Touch **3** and **0**).

NOTE:

Baking time can be set for any amount of time from 1 minute to 11 hours and 59 minutes.

START TIME

- 7 Touch **START TIME**.

1 6 3 0

- 8 Set the desired start time (Touch **1**, **6**, **3** and **0**).

START
CONTROL LOCK

- 9 Touch **START**. At the set time, a short beep will sound. The oven will begin to Bake.

CLEAR OFF

- 10 Touch **CLEAR OFF** to cancel Delayed Timed Bake at any time.

When the Delayed Timed Cook finishes:

- 1 **END OF CYCLE** and the time of day will show in the display. The oven will shut off automatically.
- 2 The control will continue to sound the cook end melody every minute until **CLEAR OFF** is touched.

CLEAR OFF

NOTE:

- If you set 24-hours clock, the maximum hours you can delay will be just 24-hours.
- During the preheating mode, the convection fan operates constantly to circulate the hot air. The convection fan will turn off automatically after the preset temperature is attained.
- After any cooking cycle has been completed cooling fans will operate to protect the control panel. This is normal.

CAUTION

- Use caution with the **TIMED BAKE** or **DELAYED TIMED BAKE** features. Use the automatic timer when cooking cured or frozen meats and most fruits and vegetables. Foods that can easily spoil, such as milk, eggs, fish, meat or poultry, should be chilled in the refrigerator first. Even when chilled, they should not stand in the oven for more than 1 hour before cooking begins, and should be removed promptly when cooking is completed. - Eating spoiled food can result in sickness from food poisoning.

OPERATING INSTRUCTIONS

BROIL

Broiling uses an intense, radiant heat to cook food. Both the inner and outer broil elements heat during full broiling. Only the inner broil element heats during center broiling. The element(s) cycle on and off in intervals to maintain the oven temperature. The meat probe cannot be used with this mode.

IMPORTANT NOTE: Your oven is designed for CLOSED DOOR Broiling.

To set the oven to Broil.

- 1 Place your food on the broiling pan grid.
- 2 Touch Broil.
- 3 Touch #1 pad for full or touch #2 pad for center broiling.
- 4 Touch #1 pad for High or touch #2 pad for Medium or touch #3 pad for Low.
- 5 Touch **START**. The oven will begin to broil.
- 6 Broil on one side until food is browned ; turn and cook on the other side.

BROIL

1
or 2

1
or 2
or 3

START
CONTROL LOCK

NOTE:

Always pull the rack out to the stop position before turning or removing food.

CLEAR OFF

- 7 When broiling is finished, touch **CLEAR OFF**.

Touch **CLEAR OFF** to cancel this function at any time.

IMPORTANT NOTE:

The heating element(s) turn off immediately when the door is opened. They will turn on again in approximately 5 seconds after the door is closed.

If you leave the oven door open for more than 30 minutes, all settings are canceled.

Touch **CLEAR OFF** to cancel Broil at any time.

NOTE:

After any cooking cycle has been completed cooling fans will operate to protect the control panel. This is normal.

RECOMMENDED BROILING GUIDE

The size, weight, thickness, starting temperature, and your preference of doneness will affect broiling times. This guide is based on meats at refrigerator temperature. It is recommended to preheat the oven for about 3 minutes before placing food in the oven.

For best results when broiling, use a pan designed for broiling (refer to Fig. 1.)

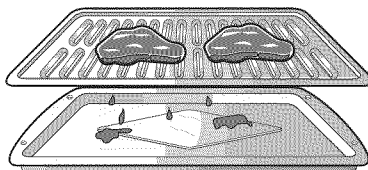
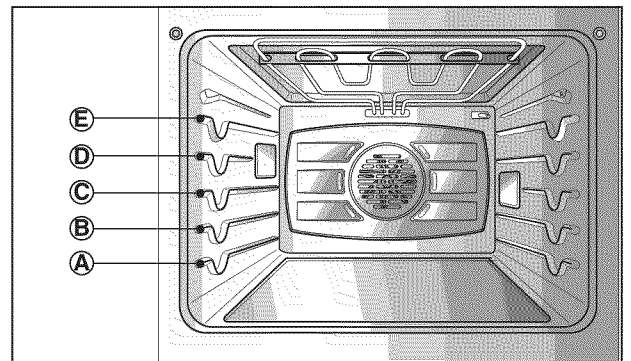

Fig.1



OPERATING INSTRUCTIONS

RECOMMENDED BROILING GUIDE (cont.)

Food	Quantity and/ or Thickness	Shelf Position	First Side Time (min.)	Second Side Time (min.)	Comments
Ground Beef Well Done	1 lb. (4 patties) 1/2 to 3/4" thick	D or E	5-7	4-5	Space evenly. Up to 8 patties may be broiled at once.
Beef Steaks Rare Medium Well Done	1" thick 1 to 1-1/2 lbs.	D D D	6 7 8	2-3 2-3 3-4	Steaks less than 1" thick cook through before browning. Pan frying is recommended. Remove fat.
Rare Medium Well Done	1-1/2" thick 2 to 2-1/2 lbs.	D D D	10 12 14	4-6 6-8 8-10	
Chicken	1 whole cut up 2 to 2-1/2 lbs., split lengthwise 2 Breasts	C C	20 20	6-8 6-10	
Lobster Tails	2-4 10 to 12 oz. each	C	12-14	Do not turn over.	Cut through back of shell. Spread open. Brush with melted butter before broiling and after half of broiling time.
Fish Fillets	1/4 to 1/2" thick	D or E	5-6	3-4	Handle and turn very carefully. Brush with lemon butter before and during cooking, if desired.
Ham Slices (precooked)	1/2" thick	D	5	3-5	Increase time 5 to 10 minutes per side for 1-1/2" thick or home-cured ham.
Pork Chops Well Done	2 (1/2" thick) 2 (1" thick) about 1 lb.	D or E D or E	7 9-10	6-8 7-9	Remove fat.
Lamb Chops Medium Well Done	2 (1" thick) about 10 to 12 oz.	D D	6 8	4-6 7-9	Remove fat.
Medium Well Done	2 (1-1/2" thick) about 1 lb.	D D	11 13	9 9-11	
Salmon Steaks	2 (1" thick) 4 (1" thick) about 1 lb.	D or E D or E	8 9	3-4 4-6	Grease pan. Brush steaks with melted butter.

CAUTION

- Should an oven fire occur, leave the oven door closed and turn the oven off. If the fire continues, throw baking soda on the fire or use a fire extinguisher.
- **DO NOT put water or flour on the fire.**
 - Flour may be explosive and water can cause a grease fire to spread and cause personal injury.

CAUTION



- **DO NOT use the broiler pan without the grid.**
- **DO NOT cover the grid with aluminum foil.**

OPERATING INSTRUCTIONS

ROAST

The oven can be programmed to roast.



To set the Roast feature (example for Meats to cook at 375°F):

-  1 Touch **ROAST**.
-  2 Set the oven temperature (Touch **3**, **7** and **5**)
-  3 Touch **START**.

NOTE:

After any cooking cycle has been completed cooling fans will operate to protect the control panel. This is normal.

To change the Temperature while cooking (example changing from 375°F to 425°F):

-  1 Touch **ROAST**.
-  2 Set the oven temperature (Touch **4**, **2** and **5**)
-  3 Touch **START**.

IMPORTANT NOTE:

The heating elements turn off immediately when the door is opened. They will turn on again in approximately 5 seconds after the door is closed. If you leave the oven door open for more than 30 minutes, all settings are canceled.

When preparing meats for roasting, use the broiler pan and grid. The broiler pan will catch grease spills and the grid will help prevent grease splatters.

Touch **CLEAR OFF** to cancel Roast at any time.

OPERATING INSTRUCTIONS

CONVECTION BAKE

Benefits of Convection Bake:

- 1 Some foods cook up to 25 to 30% faster, saving time and energy.
- 2 Multiple rack baking.
- 3 No special pans or bakeware needed.

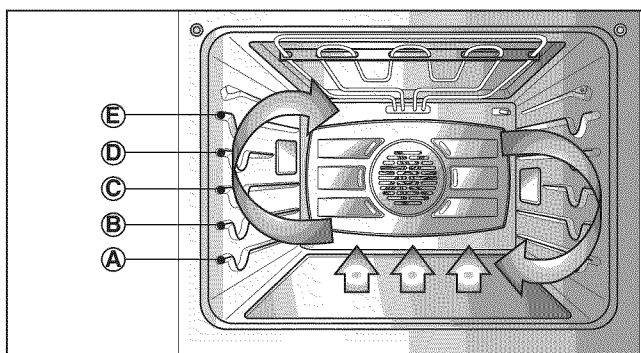

Convection baking uses a fan to circulate the oven's heat evenly and continuously within the oven. This improved heat distribution allows for even cooking and excellent results using multiple racks at the same time. Foods cooked on a single oven rack will generally cook faster and more evenly with Convection Bake. Multiple oven rack cooking may slightly increase cook times for some foods, but the overall result is time saved. Breads and pastries brown more evenly.

Tips for Convection Bake

- Time reductions will vary depending on the amount and type of food to be cooked. Cookies and biscuits should be baked on pans with no sides or very low sides to allow heated air to circulate around the food. Food baked on pans with a dark finish will cook faster.
- When using Convection Bake with a single rack, place oven rack in position C. If cooking on multiple racks, place the oven racks in position B and D.
- Cookies, muffins, biscuits and other quickbreads give very good results when using multiple racks.

NOTE:

After any cooking cycle has been completed cooling fans will operate to protect the control panel. This is normal.

To set oven to Convection BAKE and temperature to 375°F:



- 1 Touch **CONV. BAKE**. The display will flash **350 deg F**.
- 2 Set the oven temperature (Touch **3**, **7** and **5**).
- 3 Touch **START**. The display will show **CONV BAKE** and the converted temperature starting at 100°F. As the oven preheats, the display will show increasing temperatures in 5 degree increments. Once the oven reaches the desired adjusted temperature, a tone will sound. The display will show the auto converted oven temperature **350 deg F**, **CONV BAKE** and the fan icon.
- 4 Touch **CLEAR OFF** to cancel Convection Bake at any time.

IMPORTANT NOTE:

The heating elements and a fan turn off immediately when the door is opened. They will turn on again in approximately 5 seconds after the door is closed. If you leave the oven door open for more than 30 minutes, all settings are canceled.

Touch **CLEAR OFF** to cancel Convection Bake at any time.

Displays of the CONV. BAKE mode

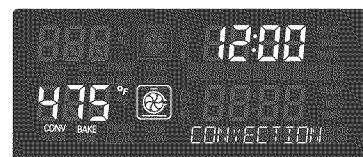

OPERATING INSTRUCTIONS

CRISP CONVECTION

Benefits of Crisp Convection:

This crisp convection feature is best for light colored and delicate baked goods like cakes, tarts, cookies, puff pastries, scones, muffins, biscuits, free from yeast breads etc. The fan circulated hot air continually distributes heat more evenly than the natural movement of air in a standard thermal oven. This movement of hot air maintains cooking foods more evenly, crisping surfaces while sealing in moisture and yielding crustier breads. The low thermal capacity of the heating element itself makes it possible to shorten the cooking time as much as 30%.

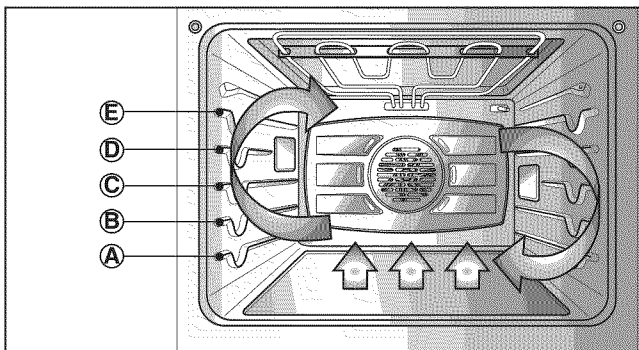

Tips for Crisp Convection

- Time reductions will vary depending on the amount and type of food to be cooked. Choose cookie sheets without sides and roasting pans with very low sides to allow heated air to circulate around the food. Food baked on pans with a dark finish will cook faster.
- When using Crisp Convection with a single rack, place oven rack in position C. If cooking on multiple racks, place the oven racks in position B and D.
- It is important to uncover foods so that surfaces of food remain exposed to the circulating air, allowing browning and crisping.
- Keep heat loss to a minimum by only opening the oven door when necessary.

To set oven for Crisp Convection and temperature to 375°F:



- 1 Touch **CRISP CONV.** The display will flash **350 deg F.**



- 2 Set the oven temperature (Touch **3, 7 and 5**).



- 3 Touch **START.** The display will show **CONV** and the converted temperature starting at 100°F. As the oven preheats, the display will show increasing temperatures in 5 degree increments. Once the oven reaches the desired adjusted temperature, a tone will sound. The display will show the auto converted oven temperature **350 deg F, CONV** and the fan icon.



- 4 Touch **CLEAR OFF** to cancel Crisp Convection at any time.

IMPORTANT NOTE:

The heating elements and a fan turn off immediately when the door is opened. They will turn on again in approximately 5 seconds after the door is closed. If you leave the oven door open for more than 30 minutes, all settings are canceled.

Touch **CLEAR OFF** to cancel Crisp Convection at any time.

NOTE:

After any cooking cycle has been completed cooling fans will operate to protect the control panel. This is normal.

CONVECTION ROAST

This Convection Roast feature is designed to give optimum cooking performance for roasting meats and poultry. Preheating is not necessary for meats and poultry. Heated air circulates around the food from all sides, sealing in juices and flavors. Foods are crispy brown on the outside while staying moist on the inside.

Convection Roast is especially good for large tender cuts of meat. The meat probe may be used in this feature.

To set the oven to CONVECTION ROAST and the temperature to 375°F):

① Arrange oven racks and place food in oven.

**CONV.
ROAST**

② Touch **CONV. ROAST**. The display will flash **350 deg F**.

3 7 5

③ Set the oven temperature (Touch **3**, **7** and **5**).

START
CONTROL LOCK

④ Touch **START**. The display will show **CONV ROAST** and the changing temperature starting at 100°F. As the oven preheats, the display will show increasing temperatures in 5 degree increments. Once the oven reaches the desired adjusted temperature, a tone will sound. The display will show the auto converted oven temperature **350 deg F**, **CONV ROAST** and the fan icon.

**CLEAR
OFF**

⑤ Touch **CLEAR OFF** to cancel this function at any time.

IMPORTANT NOTE:

The heating elements and a fan turn off immediately when the door is opened. They will turn on again in approximately 5 seconds after the door is closed. If you leave the oven door open for more than 30 minutes, all settings are canceled.

When preparing meats for roasting, use the broiler pan and grid. The broiler pan will catch grease spills and the grid will help prevent grease splatters.

Touch **CLEAR OFF** to cancel the Convection Roast feature at any time.

NOTE:

After any cooking cycle has been completed cooling fans will operate to protect the control panel. This is normal.

Displays of the CONV. ROAST mode





OPERATING INSTRUCTIONS

WARM

The WARM function will maintain an oven temperature of less than 200°F. This function should not be used to reheat cold food. The Warm function will keep cooked food warm for serving up to 3 hours after cooking has finished.

After 3 hours the WARM function will shut the oven OFF automatically. The Warm function may be used without any other cooking operations or can be used after cooking has finished using TIMED COOK or DELAYED TIMED COOK.

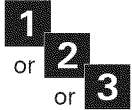



To set Warm feature :

-  Touch the **WARM/PROOF** once.
-  Touch **#1** pad for High or touch **#2** pad for Medium or touch **#3** pad for Low.
-  Touch **START**.
-  To turn Warm off, touch **CLEAR OFF** at any time.

NOTE:

The warm feaure has three temperature levels :
High=200 °F, Med=170 °F, Low=140 °F

To set Warm feature after timed cooking

-  Set the cooking feature that you want to use: **TIMED (BAKE, CONV. BAKE, CONV. ROAST), DELAYED TIMED (BAKE, CONV. BAKE, CONV. ROAST)** refer to the relevant previous page.
-  Touch **START**.
-  Touch **WARM/PROOF** once. **COOK & WARM** mode is set to turn on automatically after completing the **TIMED COOKING** or **DELAYED TIMED COOKING**.
-  To turn Cook & Warm off at any time touch **CLEAR OFF**.

Displays of the WARM mode



OPERATING INSTRUCTIONS

PROOF

The Proof feature maintains a warm environment for rising yeast leavened products before baking. To avoid lowering the oven temperature and lengthening proofing time, do not open the oven door unnecessarily. Check bread products early to avoid over-proofing.

NOTE:

For best results, cover the dough with a cloth or with plastic wrap (the plastic may need to be anchored underneath the container so the oven fan does not blow it off).

To set Proof (example for 1 hour) :



① Touch **WARM/PROOF** Twice.



② Touch **1, 0 and 0**.



③ Touch **START**. The proof feature automatically provides the optimum temperature for the proof process, and therefore does not have a temperature adjustment.



④ When proofing is finished, touch **CLEAR OFF**.

NOTE:

- Do not use the proofing mode for warming food or keeping food hot. The proofing oven temperature is not hot enough to hold foods at safe temperatures. Use the WARM feature to keep food warm.
- Proofing will not operate when oven is above 125°F. Oven is Hot will show in the display.

Displays of the PROOF mode

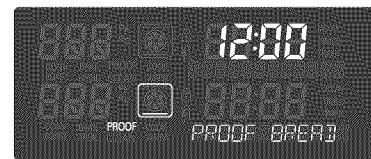

TO TURN ON/OFF THE OVEN LIGHT



The oven light automatically turns ON when the door is opened. The oven light may also be manually turned ON or OFF by touching the **OVEN LIGHT feature**.

NOTE:

The oven light cannot be turned on if the self clean feature is active.

OPERATING INSTRUCTIONS

CONTROL LOCK FEATURE

The START pad controls the Control Lockout feature. The Control Lockout feature automatically locks most oven controls from being turned ON. It does not disable the clock, timer or the interior oven light.

Activate the lock out feature:



- 1 Touch and hold **START** pad for 3 seconds.
- 2 Lock melody will sound, **CONTROL LOCKOUT** will appear.

Deactivate normal oven operation:



- 1 Touch and hold **START** pad for 3 seconds. Unlock melody will sound. **CONTROL LOCKOUT** will disappear.
- 2 The oven is fully operational again.

NOTE:

- In case of Control Lockout mode, Clock, kitchen Timer and Oven light function continue to operate.

FAVORITE

The FAVORITE feature is used to record and recall your favorite recipe settings. This feature may store and recall up to 3 different settings. The Favorite Setting feature may be used with COOK TIME feature. This feature will not work with any other function including START TIME feature.

- 1 Place the food in the oven.



- 2 Touch **FAVORITE** once for Bread, twice for Meat, and 3 times for Chicken. Default temperature will appear and COOK will flash.



- 3 Press the **number** pads to set the desired oven temperature. This temperature will be stored and be recalled next use.



- 4 Press the **START** feature. The preheat indicator tones will sound 3 times when the oven reaches the programmed temperature.

NOTE:

- Only the temperature you selected will be stored, not the cooking time.
- If the oven temperature is changed, the changed temperature will be stored.

Category	How to Select Touch Favorite	Default Temp. (may be changed and recalled)	Operating Feature
1. Bread	Touch FAVORITE pad once.	375°F	BAKE
2. Meat	Touch FAVORITE pad twice.	325°F	Convection Roast
3. Chicken	Touch FAVORITE pad 3 times.	350°F	Convection Roast

SELF-CLEAN

The self-clean cycle uses above normal cooking temperatures to clean the oven's interior automatically.

It is normal for smoking to occur during cleaning if the oven is heavily soiled. It is better to clean the oven regularly rather than to wait until there is a heavy build-up of soil in the oven.

During the cleaning process, the kitchen should be well ventilated to get rid of normal odors associated with cleaning.

Self Clean can only be run in one oven at a time. While Self clean is running the other oven can not be used for any function.

Before a self-clean Cycle

We recommend venting your kitchen with an open window or using a ventilation fan or hood during the first self-clean cycle.

Remove the oven racks, broiler pan, broiler grid, all cookware, and aluminum foil or any other material from the oven.

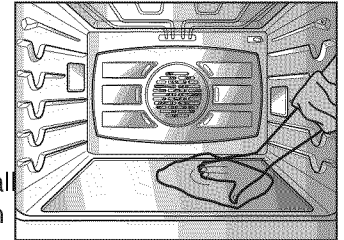

CAUTION

- **DO NOT leave small children unattended near the appliance.**
 - During the self-cleaning cycle, the outside of the oven can become very hot to touch.
- **Move Birds to another well-ventilated room.**
 - The health of some birds is extremely sensitive to the fumes given off during the self-cleaning cycle of any oven.
- **DO NOT line the oven walls, racks, bottom or any other part of the oven with aluminum foil or any other material.**
 - Doing so will destroy heat distribution, produce poor baking results and cause permanent damage to the oven interior (aluminum foil will melt to the interior surface of the oven.)
- **DO NOT force the door open.**
 - This can damage the automatic door locking system. Use care when opening the oven door after the self-cleaning cycle. Stand to the side of the oven when opening the door to allow hot air or steam to escape. The oven may still be VERY HOT.
- **DO NOT block the oven vent(s) during the self-cleaning cycle.**
 - This can damage the electric parts of the oven. Air must be able to move freely.

NOTE:

Remove all racks including the telescoping rack before you begin a self clean cycle.

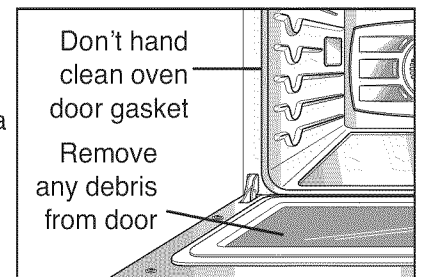

- The silver-colored oven racks can be self-cleaned, but they will darken, lose their luster, and become hard to slide. It is recommended to remove all racks before starting the self clean cycle.
- Soil on the front frame of the range and outside the gasket on the door will need to be cleaned by hand. Clean these areas with hot water, soap-filled steel-wool pads, or cleansers such as Soft Scrub; Rinse well with clean water and dry.
- Do not clean the gasket. The fiberglass material of the oven door gasket cannot withstand abrasion. It is essential for the gasket to remain intact. If you notice it becoming worn or frayed, replace it.
- Wipe up any heavy spillovers on the oven bottom.
- Make sure the oven light bulb cover is in place and the oven light is off.
- Do not leave baking/ pizza stone in the oven during the self-clean cycle.

OPERATING INSTRUCTIONS

SELF-CLEAN (cont.)

The **SELF CLEAN** pad is used to start a Self Clean cycle. When used with **START TIME** pad, a delayed Self Clean cycle may also be programmed. The Self Clean function has cycle times of 2, 3, or 4 hours.

NOTE:

Before running a self-clean cycle be sure to remove all racks and accessories.

- 1 Be sure the clock is set with the correct time of day, the ovens are empty and both oven doors are closed.

**SELF
CLEAN**

- 2 Touch **SELF CLEAN** once for a 3-hour clean time, twice for a 4-hour clean time, or 3 times for 2-hour clean time. A 3-hour selfclean time is recommended for use when cleaning small, contained spills. A self clean time of 4 hours is recommended for heavily soiled ovens.

START
CONTROL LOCK

- 3 Touch **START**. The **DOOR LOCKED** icon will flash.
- 4 Once the **SELF CLEAN** is set, the oven door will lock automatically. You will not be able to open the oven door until the oven is cooled. The lock will release automatically.

During the self-clean cycle

- You may see some smoke and smell an odor the first few times the oven is cleaned. This is normal and will lessen in time. Smoke may also occur if the oven is heavily soiled or if a broiler pan was left in the oven.
- As the oven heats, you may hear sounds of metal parts expanding and contracting. This is normal and will not damage the oven.
- Do not force the oven door open when LOCK is displayed. The oven door will remained locked until the oven temperature has cooled. Forcing the door open will damage the door.

To set a delay start time

**SELF
CLEAN**

- 1 Touch **SELF CLEAN**. Select the desired self clean time by touching **SELF CLEAN**.

**START
TIME**

- 2 Touch **START TIME**. DELAY is flashing

1 2 3

- 3 Set the desired start time.

START
CONTROL LOCK

- 4 Touch **START**. DELAY and CLEAN will remain on.

- 5 Self Cleaning cycle will turn on automatically at the set time.

Displays of the SELF CLEAN mode

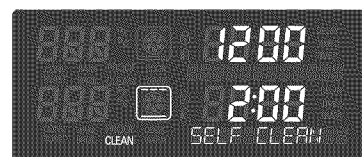

IMPORTANT NOTE:

If it becomes necessary to stop or interrupt a self-cleaning cycle due to excessive smoke or fire in the oven, touch **CLEAR OFF** to cancel self-clean at any time. The door lock will automatically release allowing you to open the oven door after the oven has cooled down.

SELF-CLEAN (cont.)

If it becomes necessary to stop or interrupt a selfcleaning cycle due to excessive smoke or fire in the oven:



① Touch **CLEAR OFF**.

② After the oven has cooled down, the **DOOR LOCK** will automatically release allowing you to open the oven door.

NOTE:

When using the self-clean feature:

- A self-clean cycle cannot be started if Control Lock feature is active.
- Once the SELF CLEAN is set, the oven door will lock automatically. You will not be able to open the oven door until the oven is cooled. The lock will release automatically.
- Once the door has been locked the DOOR LOCKED indicator light will stop flashing and remain on. Allow about 15 seconds for the oven door lock to engage.

When the self-clean cycle is done

- It will not be possible to open the oven door until oven temperature has cooled.

After the self-clean cycle

- You may notice some white ash in the oven. Wipe it off with a damp cloth after the oven cools. These deposits are usually a salt residue that cannot be removed by the clean cycle. If the oven is not clean after one clean cycle, repeat the cycle.
- If oven racks were left in the oven and do not slide smoothly after a clean cycle, wipe racks and rack supports with a small amount of vegetable oil to make them glide easier.
- Fine lines may appear in the porcelain because it went through heating and cooling. This is normal and will not affect performance.

CARE & CLEANING

Changing the Oven Light

The oven light is a standard 10-watt halogen bulb for ovens.

To replace lamps located on the side wall:

• Make sure oven and bulb are cool.

1. Unplug oven or disconnect power.
2. Remove oven racks.
3. Slide a flat blade screwdriver between the housing and the glass light cover.
4. Support the glass light cover with two fingers to prevent the cover from falling to the bottom of the oven.
5. Gently twist the screwdriver blade to loosen the glass light cover.
6. Remove bulb from socket.
7. Replace bulb, replace light cover by snapping back into place.
8. Plug in oven or reconnect power.

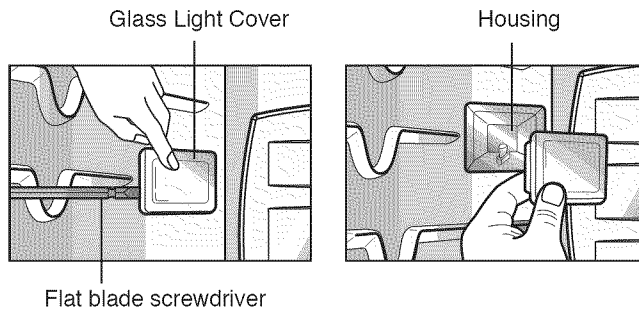

To replace a lamp located on the top wall:

• Make sure oven and bulb are cool.

1. Unplug oven or disconnect power.
2. Remove oven racks.
3. Slide a flat blade screwdriver between the housing and the glass light cover.
4. Support the glass light cover with two fingers to prevent the cover from falling to the bottom of the oven.
5. Gently twist the screwdriver blade to loosen the glass light cover.
6. Remove bulb from socket.
7. Replace bulb, replace light cover by snapping back into place and push the clip to hold the glass light cover tightly.
8. Plug in oven or reconnect power.

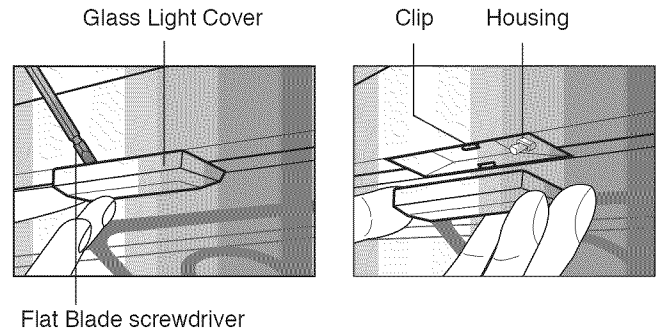

⚠ WARNING

- Before replacing your oven light bulb, **DISCONNECT** the electrical power to the oven at the main fuse or circuit breaker panel.
- Failure to do so can result in severe personal injury, death, or electrical shock.
- **Make sure oven and bulb are cool.**

Painted Parts and Trim

For general cleaning, use a cloth with hot and soapy water. For more difficult soils and built-up grease, apply a liquid detergent directly onto the soil. Leave on soil for 30 to 60 minutes. Rinse with a damp cloth and dry. **DO NOT** use abrasive cleaners on any of these materials; they can scratch the parts and trim.

Stainless Steel Surfaces

Do not use a steel-wool pad, it will scratch the surface.

1. Place a small amount of Stainless Steel Appliance Cleaner or polish on a damp cloth or damp paper towel.
2. Clean a small area, rubbing with the grain of the stainless steel if applicable.
3. Dry and buff with a clean, dry paper towel or soft cloth.
4. Repeat as necessary.

NOTE: If a mineral oil-based stainless steel appliance cleaner has been used before to clean the appliance, wash the surface with a mild soap and water prior to using the Stainless Steel Appliance Cleaner or polish.

CARE & CLEANING (cont.)

Broiler Pan and Grid

Do not clean the broiler pan or grid in a self-cleaning mode.

After broiling, remove the broiler pan from the oven. Remove the grid from the pan. Carefully pour out the grease from the pan into a proper container.



Wash and rinse the broiler pan and grid in hot water with a soap-filled or plastic scouring pad.

If food has burned on, sprinkle the grid with cleaner while hot and cover with wet paper towels or a dishcloth. Soaking the pan will remove burned-on foods.

Both the broiler pan and grid may be cleaned with a commercial oven cleaner.

Both the broiler pan and grid can also be cleaned in a dishwasher.

Oven Racks

Remove the oven racks before operating the self-clean cycle. Leaving the racks in place could cause discoloration. If food is spilled in the tracks, it could cause the racks to become stuck. If left, clean by using a mild, abrasive cleaner. Rinse with clean water and dry. If the racks are cleaned in the self-clean cycle, their color will turn slightly blue and finish will be dull. After the self-clean cycle is complete and the oven has cooled, rub the sides of the racks with wax paper or a cloth containing a small amount of oil. This will make the racks glide easier into the rack tracks. discoloration. If food is spilled in the tracks,

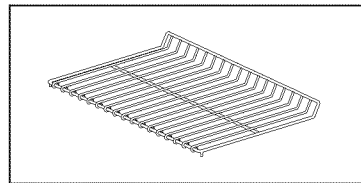

Oven Cavity

DO NOT use oven cleaners.

NEVER wipe a warm or hot porcelain surface with a damp sponge; it may cause chipping or crazing (tiny hairlike cracks.) Food spills should be cleaned when oven cools. At high temperature, foods react with porcelain and a permanent dull spot can result. When cleaning a spot, use only non-abrasive cleaners or scrubbers.

Oven Door

Use soap and water to thoroughly clean the top, sides, and front of the oven door. Rinse well. You may use a glass cleaner on the outside glass of the oven door.

DO NOT immerse the door in water. DO NOT spray or allow water or the glass cleaner to enter the door vents. DO NOT use oven cleaners, cleaning powders, or any harsh abrasive cleaning materials on the outside of the oven door.

DO NOT clean the oven door gasket. The oven door gasket is made of a woven material which is essential for a good seal. Care should be taken not to rub, damage, or remove this gasket.

CAUTION

- **DO NOT use harsh abrasive cleaners or sharp metal scrapers to clean the oven door glass since they can scratch the surface.**
- It may result in shattering of the glass.

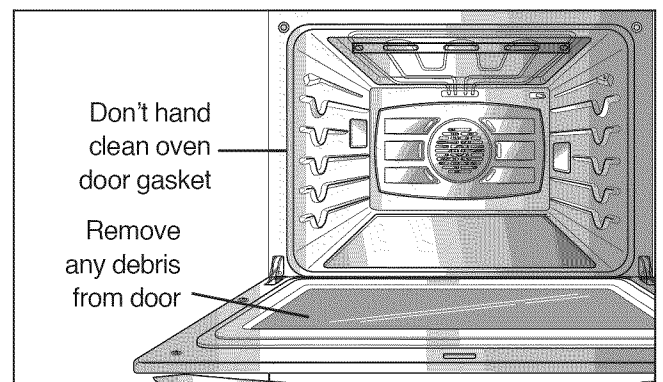

REMOVING & REPLACING THE LIFT-OFF OVEN DOOR

CAUTION

- **DO NOT use harsh abrasive cleaners or sharp metal scrapers to clean the oven door glass since they can scratch the surface.**
- It may result in shattering of the glass.

To remove the door:

Step. 1

Open the door fully.

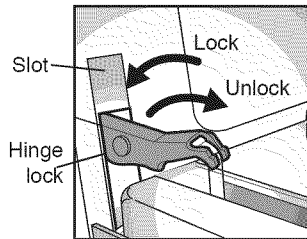

Step. 2

Pull the hinge locks down toward the door frame to the unlocked position.

Step. 3

Firmly grasp both sides of the door at the top.

Step. 4

Close door to the door removal position, which is approximately 5 degrees.

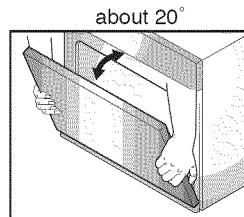

Step. 5

Lift door up and out until the hinge arm is clear of the slot.

To replace the door:

Step. 1

Firmly grasp both sides of the door at the top.

Step. 2

With the door at the same angle as the removal position, seat the indentation of the hinge arm into the bottom edge of the hinge slot. The notch in the hinge arm must be fully seated into the bottom of the slot.

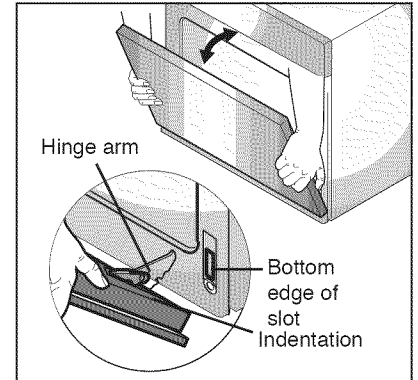

Step. 3

Open the door fully. If the door will not open fully, the indentation is not seated correctly in the bottom edge of the slot.

Step. 4

Push the hinge locks up against the front frame of the oven cavity to the locked position.

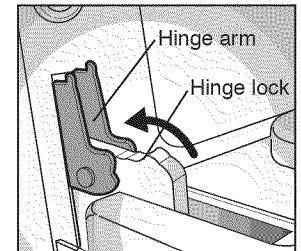

Step. 5

Close the oven door.

DOOR CARE INSTRUCTIONS

- Most oven doors contain glass that can break.

Read the following recommendations:

1. Do not close the oven door until all the oven racks are fully in place.

2. Do not hit the glass with pots, pans, or any other object.
3. Scratching, hitting, jarring, or stressing the glass may weaken its structure causing an increased risk of breakage at a later time.

BEFORE CALLING FOR SERVICE

Before you call for service, review this list. It may save you time and expense. The list includes common occurrences that are not the result of defective workmanship or materials in this appliance.

Problem	Possible Causes / Solutions								
<p>Oven control beeps and displays any F code error.</p>	<ul style="list-style-type: none"> • Electronic control has detected a fault condition. Press CLEAR OFF to clear the display and stop beeping. Reprogram oven. If fault reoccurs, record fault number. Press CLEAR OFF and contact a qualified service technician. <table border="1" data-bbox="1068 491 1523 676" style="margin-left: auto; margin-right: auto;"> <thead> <tr> <th data-bbox="1076 495 1182 527">Code</th> <th data-bbox="1185 495 1515 527">CAUSE</th> </tr> </thead> <tbody> <tr> <td data-bbox="1076 532 1182 591">F-3</td> <td data-bbox="1185 532 1515 591">Key held down too long or shorted key</td> </tr> <tr> <td data-bbox="1076 595 1182 627">F-9</td> <td data-bbox="1185 595 1515 627">No heating</td> </tr> <tr> <td data-bbox="1076 632 1182 663">F-11</td> <td data-bbox="1185 632 1515 663">Communication Error</td> </tr> </tbody> </table>	Code	CAUSE	F-3	Key held down too long or shorted key	F-9	No heating	F-11	Communication Error
Code	CAUSE								
F-3	Key held down too long or shorted key								
F-9	No heating								
F-11	Communication Error								
<p>Oven will not work</p>	<ul style="list-style-type: none"> • Plug on oven is not completely inserted in the electrical outlet. <ul style="list-style-type: none"> - Make sure electrical plug is plugged into a live, properly grounded outlet. • A fuse in your home may be blown or the circuit breaker tripped. <ul style="list-style-type: none"> - Replace the fuse or reset the circuit breaker. • Oven controls improperly set. <ul style="list-style-type: none"> - See the Using the oven section. • Oven too hot. <ul style="list-style-type: none"> - Allow the oven to cool to below locking temperature. 								
<p>Appliance does not operate.</p>	<ul style="list-style-type: none"> • Make sure cord is plugged correctly into outlet. Check circuit breakers. • Service wiring is not complete. Contact your appliance Servicer for assistance. • Power outage. Check house lights to be sure. Call your local electric company for service. 								
<p>Oven light does not work.</p>	<ul style="list-style-type: none"> • Replace or tighten bulb. See Changing Oven Light section in this Owner's manual. 								
<p>Oven smokes excessively during broiling.</p>	<ul style="list-style-type: none"> • Control not set properly. Follow instructions under Setting Oven Controls. • Meat too close to the element. Reposition the rack to provide proper clearance between the meat and the element. Preheat broil element for searing. • Meat not properly prepared. Remove excess fat from meat. Cut remaining fatty edges to prevent curling, but do not cut into lean. • Insert on broiler pan wrong side up and grease not draining. Always place grid on the broiler pan with ribs up and slots down to allow grease to drip into pan. • Grease has built up on oven surfaces. Regular cleaning is necessary when broiling frequently. Old grease or food spatters cause excessive smoking. 								

TROUBLESHOOTING

BEFORE CALLING FOR SERVICE (cont.)

Problem	Possible Causes / Solutions
Food does not bake or roast properly	<ul style="list-style-type: none"> • Oven controls improperly set. <ul style="list-style-type: none"> - See the using the oven section. • Rack position is incorrect or the rack is not level. <ul style="list-style-type: none"> - See the using the oven section. • Incorrect cookware or cookware of improper size being used. <ul style="list-style-type: none"> - See the using the oven section. • Oven sensor needs to be adjusted. <ul style="list-style-type: none"> - See the adjusting your oven temperature in option section.
Food does not broil properly	<ul style="list-style-type: none"> • Oven controls improperly set. <ul style="list-style-type: none"> - Make sure you press the BROIL pad. • Improper rack position being used. <ul style="list-style-type: none"> - See the Broiling Guide, page 19. • Cookware not suited for broiling. <ul style="list-style-type: none"> - Use the broiling pan and grid that came with your oven. • Aluminum foil used on the the broiling pan and grid has not been fitted properly and slit as recommended. <ul style="list-style-type: none"> - See the using the oven section. • In some areas the power (voltage) may be low. <ul style="list-style-type: none"> - Preheat the broil element for 10 minutes. - See the Broiling Guide, page 19.
Oven temperature too hot or too cold	<ul style="list-style-type: none"> • Oven Sensor needs to be adjusted. <ul style="list-style-type: none"> - See the adjusting your oven Temperature in option section.
Oven will not self-clean	<ul style="list-style-type: none"> • The oven temperature is too high to set a self-clean operation. <ul style="list-style-type: none"> - Allow the oven to cool and reset the controls. • Oven controls improperly set. <ul style="list-style-type: none"> - See the using the self-cleaning oven section. • A self-clean cycle cannot be started if oven door is opened.
Crackling or popping sound	<ul style="list-style-type: none"> • This is the sound of the metal heating and cooling during both the cooking and cleaning functions. <ul style="list-style-type: none"> - This is normal.
Excessive smoking during a self clean cycle	<ul style="list-style-type: none"> • Excessive soil. <ul style="list-style-type: none"> - Press the CLEAR OFF pad. Open the windows to rid the room of smoke. Wait until the self-clean mode is cancelled. Wipe up the excess soil and reset the clean.
Oven door do not open after a self clean cycle	<ul style="list-style-type: none"> • Oven is too hot. <ul style="list-style-type: none"> - Allow the oven to cool below locking temperature.

BEFORE CALLING FOR SERVICE (cont.)

Problem	Possible Causes / Solutions
Oven not clean after a self clean cycle	<ul style="list-style-type: none"> • Oven controls not properly set. <ul style="list-style-type: none"> - See the self-clean section, page 27~29. • Oven was heavily soiled. <ul style="list-style-type: none"> - Clean up heavy spillovers before starting the clean cycle. Heavily soiled ovens may need to self-clean again or for a longer period of time.
DOOR LOCKED icon are on when you want to cook	<ul style="list-style-type: none"> • The oven door is locked because the temperature inside the oven has not dropped below the locking temperature. <ul style="list-style-type: none"> - Press the CLEAR OFF pad. Allow the oven to cool.
Burning or oily odor emitting from the vent	<ul style="list-style-type: none"> • This is normal in a new oven and will disappear in time. <ul style="list-style-type: none"> - To speed the process, set a self-clean cycle for a minimum of 3 hours. See the self-clean section, page 27~29.
Cooling fan continues to run after oven is turned off	<ul style="list-style-type: none"> • The fan turns off automatically when the electronic components have cooled sufficiently. <ul style="list-style-type: none"> - This is normal.
Warm air venting into kitchen after oven has been turned off.	<ul style="list-style-type: none"> • Warm air exhaust is needed to maintain and cool down oven temperatures. It turns off automatically when the heat cools to a safe temperature. <ul style="list-style-type: none"> - This is normal.

LG ELECTRIC OVEN LIMITED WARRANTY – USA

LG Electronics Inc. will repair or replace your product, at LG's option, if it proves to be defective in material or workmanship under normal use, during the warranty period set forth below, effective from the date of original consumer purchase of the product. This limited warranty is good only to the original purchaser of the product and effective only when used in U.S.A.

WARRANTY PERIOD:	HOW SERVICE IS HANDLED:
One Year From the date of the original purchase	Any part of the oven which fails due to a defect in materials or workmanship. During this full one-year warranty , LG will also provide, free of charge , all labour and in-home service to replace the defective part.

THIS WARRANTY IS IN LIEU OF ANY OTHER WARRANTIES, EXPRESS OR IMPLIED, INCLUDING WITHOUT LIMITATION, ANY WARRANTY OF MERCHANTABILITY OR FITNESS FOR A PARTICULAR PURPOSE. TO THE EXTENT ANY IMPLIED WARRANTY IS REQUIRED BY LAW, IT IS LIMITED IN DURATION TO THE EXPRESS WARRANTY PERIOD ABOVE. LG WILL NOT BE LIABLE FOR ANY CONSEQUENTIAL, INDIRECT, OR INCIDENTAL DAMAGES OF ANY KIND, INCLUDING LOST REVENUES OR PROFITS, IN CONNECTION WITH THE PRODUCT. SOME STATES DO NOT ALLOW LIMITATION ON HOW LONG AN IMPLIED WARRANTY LASTS OR THE EXCLUSION OF INCIDENTAL OR CONSEQUENTIAL DAMAGES, SO THE ABOVE LIMITATIONS OR EXCLUSIONS MAY NOT APPLY TO YOU.

THIS LIMITED WARRANTY DOES NOT APPLY TO:

1. Service calls to correct the installation of your appliance, to instruct you how to use your appliance, to replace house fuses or correct house wiring, or to replace owner-accessible light bulbs.
2. Repairs when your appliance is used in other than normal, single-family household use.
3. Pickup and delivery. Your appliance is designed to be repairable in the home.
4. Damage resulting from accident, alteration, misuse, abuse, fire, flood, improper installation, acts of God, or use of products not approved by LG Corporation.
5. Repairs to parts or systems resulting from unauthorized modifications made to the appliance.
6. Replacement parts or repair labour costs for units operated outside the united states.
7. Any labour costs during the limited warranty period.

This warranty is extended to the original purchaser for products purchased for home use within the USA. In Alaska, the warranty excludes the cost of shipping or service calls to your home.

Some states do not allow the exclusion or limitation of incidental or consequential damages, so this exclusion or limitation may not apply to you. This warranty gives you specific legal rights, and you may also have other rights which vary from states to states. To know what your legal rights are, consult your local or state consumer affairs or your state's Attorney General.

CUSTOMER ASSISTANCE INFORMATION:

To Prove Warranty Coverage	Retain your Sales Receipt to prove date of purchase. A copy of your Sales Receipt must be submitted at the time warranty service is provided.
To Obtain Nearest Authorized Service Center or Sales Dealer, or to Obtain Product, Customer, or Service Assistance	Call 1-800-243-0000 (Phone answered 24 hours - 365 days a year) and choose the appropriate prompt from the menu; or visit our website at: http://us.lg.com .



LG Customer Information Center

1-800-243-0000 USA, Consumer User

1-888-865-3026 USA, Commercial User

Register your product Online!

www.lg.com