

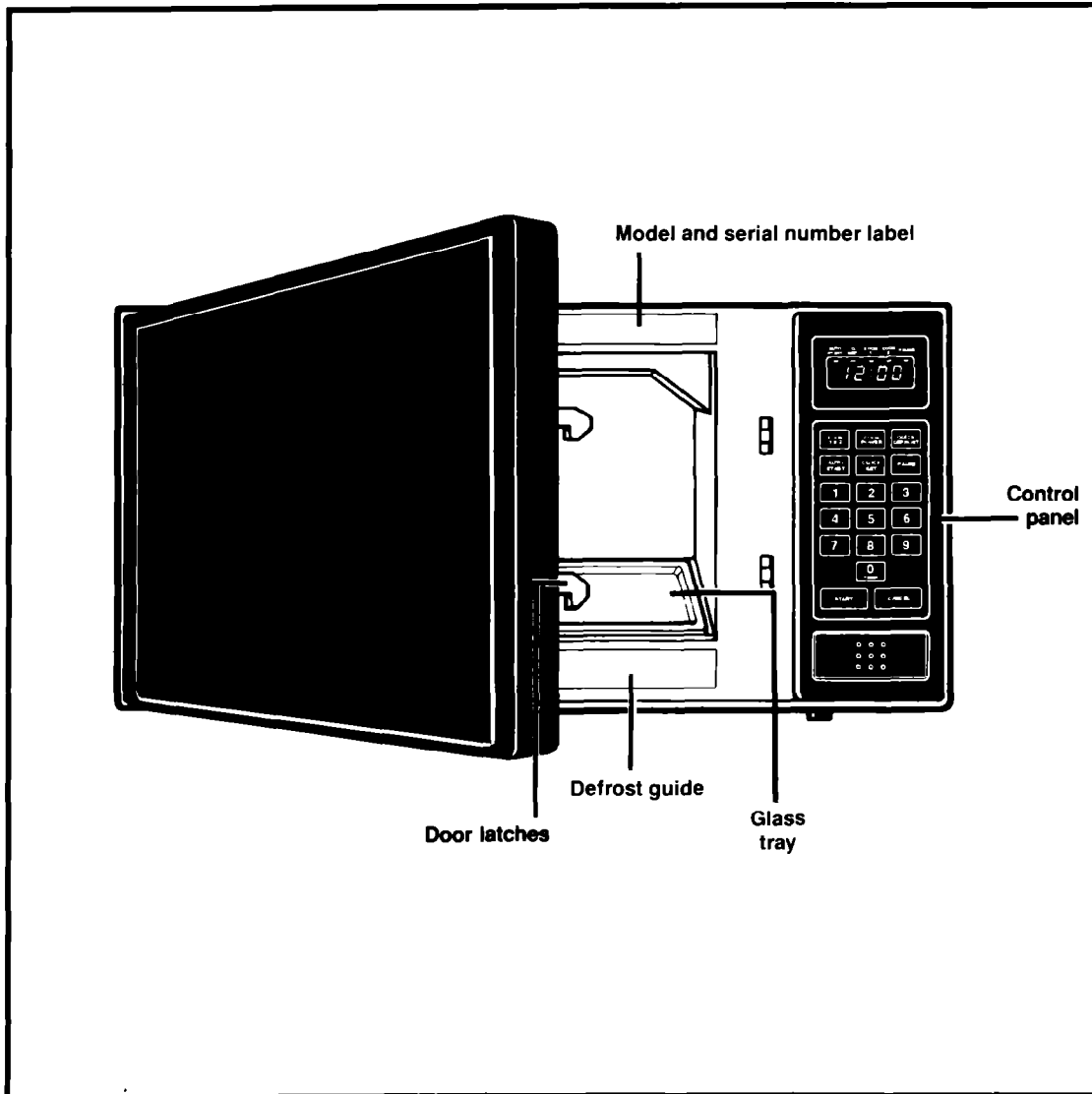

# Use & Care Guide



**MICROWAVE OVEN**  
**MS 1451XW / MS 1650XW**

# Contents

	Page
<b>Important Safety Instructions</b> .....	3
<b>Precautions To Avoid Possible Exposure To Excessive Microwave Energy</b> .....	4
<b>Getting Acquainted</b> .....	5
Microwave oven features .....	5
Control panel features .....	6
Quick reference cooking guide .....	7
<b>Using Your Microwave Oven</b> .....	9
Microwave oven controls .....	9
Audible signals .....	10
Setting the clock .....	10
Cooking in your microwave oven .....	11
Cooking at high cook power .....	12
Cooking at lower cook powers .....	13
Defrosting .....	15
Cooking automatically after defrosting .....	17
Cooking in more than one cook cycle .....	19
Using PAUSE .....	22
Using the Minute Timer .....	23
Using Auto Start .....	24
Other operating hints .....	25
<b>Installation Instructions</b> .....	26
<b>Caring For Your Microwave Oven</b> .....	28
Cleaning the microwave oven .....	28
<b>How Your Microwave oven Works</b> .....	29
<b>Operating Safety Precautions</b> .....	30
Glass Tray .....	32
<b>If You Need Service Or Assistance</b> .....	34
<b>Microwave Cooking Recipes and Tables</b> .....	36
<b>Whirlpool Microwave Oven Warranty</b> .....	60

© 1990 Whirlpool Corporation

**Thank you for buying a Whirlpool appliance. Please complete and mail the Owner Registration Card provided with this product.** Then complete the form below. Have this information ready if you need service or call with a question.

- Copy model and serial numbers from plate (behind the microwave oven door on the frame) and purchase date from sales slip.
- Keep this book the cooking guide and sales slip together in a handy place.

---

**Model Number**

---

**Serial Number**

---

**Purchase Date**

---

**Service Company Phone Number**

**Fill out and return the Microwave Registration Card included with your microwave oven.** If the card is missing, please send the model and serial number of your microwave oven, with your name and address to . . .

Whirlpool Corporation  
 Microwave Registration Department  
 Administrative Center  
 2000 M-63  
 Benton Harbor, Michigan 49022

This information will help us reach you if there is ever a need to pass along information about your microwave oven.

# Important Safety Instructions

Microwave ovens have been thoroughly tested for safe and efficient operation. However, as with any appliance, there are special installation and safety precautions which must be followed to ensure safe and satisfactory operation and prevent damage to the unit.

## **▲ WARNING**

To reduce the risk of fire, electrical shock, injury to persons or damage when using the microwave oven, follow basic precautions, including the following:

- Read all instructions before using the microwave oven.
- Read and follow the specific "Precautions To Avoid Possible Exposure To Excessive Microwave Energy" found on page 4.
- This appliance must be grounded. Connect only to properly grounded outlet. See Grounding Instructions found on page 27.
- Install or locate this appliance only in accordance with the provided Installation Instructions found on page 26.
- Some products such as whole eggs and sealed containers — for example, closed glass jars — may explode and should not be heated in this oven.
- Use this appliance only for its intended use as described in this manual.
- As with any appliance, close supervision is necessary when used by children.
- Do not operate this appliance if it has a damaged cord or plug, if it is not working properly, or if it has been damaged or dropped. Electrical shock, fire or other hazards may result.
- This appliance should be serviced only by qualified service personnel. Call an authorized Whirlpool<sup>SM</sup> service company for examination, repair or adjustment.
- Do not cover or block any opening on the appliance. Fire may result.
- Do not use outdoors. Damage to the oven or electrical shock may result.
- Do not immerse cord or plug in water. Electrical shock may result.
- Keep cord away from heated surfaces. Electrical shock may result.
- Do not let cord hang over edge of table or counter. Electrical shock may result.
- See door surface and interior cleaning instructions on page 28.
- To reduce the risk of fire in the oven cavity:
  - Do not overcook food. Carefully attend appliance if paper, plastic, or other combustible materials are placed inside the oven to facilitate cooking. Paper can char or burn, and some plastics can melt if used when heating foods.
  - Do not deep fry in oven.
  - **Test dinnerware or cookware before using.** See page 33. Some dishes (melamine, Centura<sup>®</sup>, etc.) absorb microwave energy, becoming too hot to handle and slowing cooking times. Remove wire twist-ties from paper or plastic bags before placing bag in oven. Cooking in metal containers can damage the oven. So can containers with hidden metal (twist-ties, foil lining, staples, metallic glaze or trim).
  - If materials inside the oven should ignite, keep oven door closed, turn oven off, and disconnect the power cord, or shut off power at the fuse or circuit breaker panel.
- Do not heat, store or use flammable materials in or near the oven. Fumes can create a fire hazard or explosion.
- Read and follow "Operating Safety Precautions" starting on page 30.

**—SAVE THESE INSTRUCTIONS—**

**You are responsible for:**

- Installing and leveling the oven on a surface strong enough to support its weight, and where it is protected from the elements.\* The microwave oven should be at a temperature above 50°F (10°C) for proper operation.
  - Properly connecting the oven to electrical supply and grounding it.\*
  - Operating the oven with the glass tray in place.
  - Making sure the oven is not used by anyone unable to operate it properly.
  - Properly maintaining the oven.
  - Using the microwave oven only for jobs expected of a home microwave oven.
- \* See the Installation Instructions.

## Precautions To Avoid Possible Exposure To Excessive Microwave Energy . . .

**Do not** attempt to operate this oven with the door open since open-door operation can result in harmful exposure to microwave energy. It is important not to defeat or tamper with the safety interlocks.

**Do not** place any object between the oven front face and the door or allow soil or cleaner residue to accumulate on sealing surfaces.

**Do not** operate the oven if it is damaged. It is particularly important that the oven door close properly and that there is no damage to the:

- (1) Door (bent),
- (2) Hinges and latches (broken or loosened),
- (3) Door seals and sealing surfaces.

**Do not** operate the microwave oven if the door window is broken.

The microwave oven should be checked for microwave leakage by qualified service personnel after a repair is made.

The oven should not be adjusted or repaired by anyone except properly qualified service personnel.

**Do not** operate the microwave oven with the outer cabinet removed.

**NOTE:**

1. Short power-supply cord is provided to reduce the risks resulting from becoming entangled in or tripping over a longer cord.
2. Longer cord sets or extension cords are available and may be used if care is exercised in their use.
3. If a long cord or extension cord is used, (1) the marked electrical rating of the cord set or extension cord should be at least as great as the electrical rating of the appliance, (2) the extension cord must be a grounding-type 3-wire cord, and (3) the longer cord should be arranged so that it will not drape over the countertop or tabletop where it can be pulled on by children or tripped over accidentally.

# Getting Acquainted

## Microwave oven features

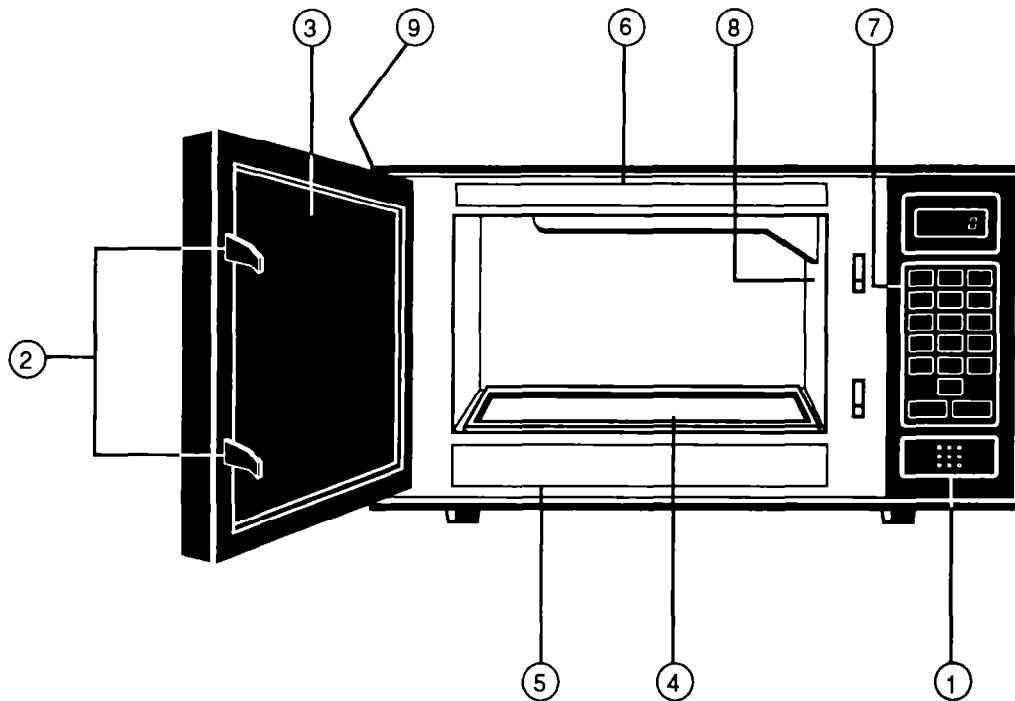

Your microwave oven is designed to make your cooking experience as enjoyable and productive as possible. To help get you up and running quickly, the following is a list of the oven's basic features:

- 1. Door Button.** Door must be pressed firmly shut for oven to operate.
- 2. Door Safety Lock System.**
- 3. Window with Metal shield.** Shield prevents microwaves from escaping. It is designed as a screen to allow you to view food as it cooks.
- 4. Glass Tray.** It must be in oven during operation for best cooking results. See page 32 for more details.
- 5. Defrost Guide.**
- 6. Model and Serial Number Plate.**
- 7. Control Panel.** Touch pads on this panel to perform all functions. See page 6 for more details.
- 8. Light.** Automatically turns on when door is opened or when oven is operating.
- 9. External Oven Air Vents.**

## Control panel features

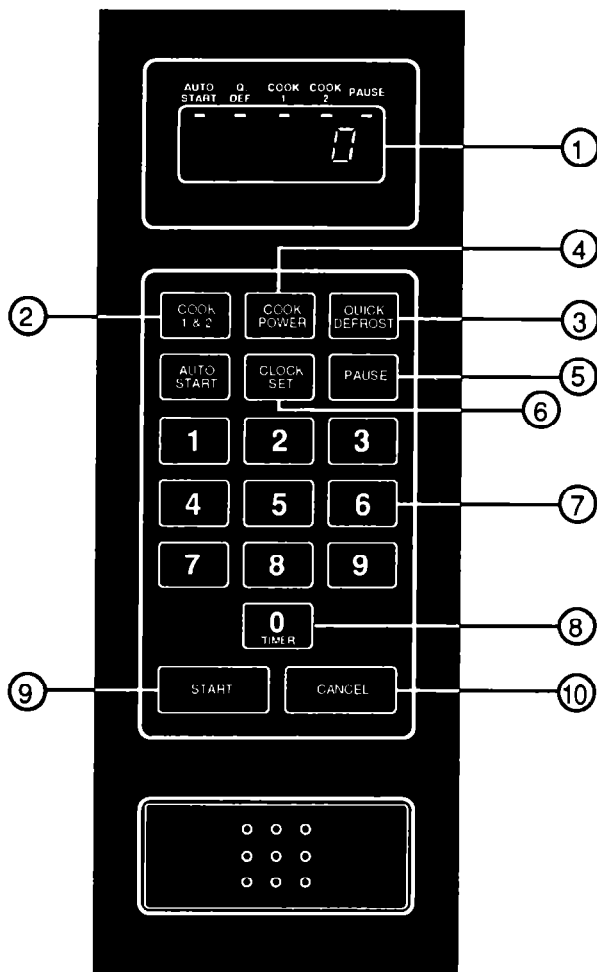

Your microwave oven control panel lets you select the desired cooking function quickly and easily. All you have to do is touch the necessary Command Pad. The following is a list of all the Command and Number Pads located on the control panel. For more information, See pages 9-24.

**1. Digital Display.** This display includes clock and indicator lights to tell you time of day, cooking time settings and cooking functions selected. See page 9 for more information.

- 2. COOK 1 & 2.** Touch this pad when cooking at only one Cook Power or cooking automatically after defrosting. Use COOK 1 & 2 to set the first Cook cycle, second Cook cycle and when cooking at more than one Cook Power. This Command Pad is also used when setting the Minute Timer or a delayed start time. See pages 12, 13, 17, 19 and 23 for more information.
- 3. QUICK DEFROST.** Touch this pad followed by Number Pads to thaw frozen food before cooking. See pages 15-16 for more information.
- 4. COOK POWER.** Touch this pad followed by a Number Pad to set the amount of microwave energy released to cook the food. The higher the number, the higher the power or "heat". See page 13 for more information. See the recipe section starting on page 36 for specific Cook Powers to use for the foods you are cooking.
- 5. PAUSE.** Touch this pad when you want the oven to pause between Cook cycles. Pausing between cycles gives you time to stir, turn over or rearrange the food, or to add ingredients. See page 22 for more information.
- 6. CLOCK SET.** Touch this pad followed by Number Pads to set the time of day. See pages 10-11 for more information.
- 7. Number Pads.** Touch a Number Pad after touching a Command Pad to tell the oven what time or Cook Power you wish to enter.
- 8. "0" Number Pads.** Touch this Number Pad when setting the Minute Timer. See pages 23-24 for more information.
- 9. START.** Touch this pad after setting a function on the microwave oven to start the function.
- 10. CANCEL.** Touch this pad once to stop the oven or to cancel a reminder tone. Touch it twice to remove the programming tone, reminder tone and Minute Timer signal completely.

## Quick reference cooking guide

Your microwave oven gives you a wide range of cooking capabilities. The following chart can be used as a quick reference when cooking. For more in-depth information, see the corresponding sections in this Use and Care Guide.

Type of cooking	How you use it	Why you use it
<b>High power cooking</b>	<ol style="list-style-type: none"> <li>1. Put food in the oven and close the door.</li> <li>2. Touch COOK 1 &amp; 2.</li> <li>3. Touch Number pads for the cooking time you want.</li> <li>4. Touch START.</li> </ol>	This mode is useful for quick cooking of small items and separate portions.
<b>Lower power cooking (Cook Power 1-9)</b>	<ol style="list-style-type: none"> <li>1. Put food in the oven and close the door.</li> <li>2. Touch COOK 1 &amp; 2.</li> <li>3. Touch Number Pads for the cooking time you want.</li> <li>4. Touch COOK POWER.</li> <li>5. Touch a Number Pad for the Cook Power you want.</li> <li>6. Touch START.</li> </ol>	This mode is necessary for efficient cooking of most foods. Failure to use the correct Cook Power may result in over or under-cooking.
<b>Defrosting</b>	<ol style="list-style-type: none"> <li>1. Put food in the oven and close the door.</li> <li>2. Touch QUICK DEFROST.</li> <li>3. Touch Number Pads for the defrosting time you want.</li> <li>4. Touch START.</li> </ol>	This mode decreases the amount of time needed to thaw frozen food before cooking.
<b>Two-cycle cooking</b>	<ol style="list-style-type: none"> <li>1. Put food in the oven and close the door.</li> <li>2. Touch COOK 1 &amp; 2.</li> <li>3. Touch Number Pads for the cooking time you want.</li> <li>4. Touch COOK POWER. (To use HIGH power, skip to Step 6.)</li> <li>5. Touch a Number Pad for the Cook Power you want in the first cycle.</li> <li>6. Touch COOK 1 &amp; 2 again.</li> <li>7. Touch Number Pads for the cooking time you want in the second cycle.</li> <li>8. Touch COOK POWER. (If you want to use HIGH power, skip to Step 10.)</li> <li>9. Touch a Number Pad for the Cook Power you want in the second cycle.</li> <li>10. Touch START.</li> </ol>	This mode lets you cook at two different Cook Powers, one after another. Using this mode lets you fine-tune your cooking for better results.

continued on next page

**Getting Acquainted  
Continued**

<b>Type of cooking</b>	<b>How you use it</b>	<b>Why you use it</b>
<b>Pause</b>	<ol style="list-style-type: none"><li>1. Put food in the oven and close the door.</li><li>2. Touch in the desired cooking instruction for COOK 1.</li><li>3. Touch PAUSE.</li><li>4. Touch in the desired cooking instructions for COOK 1.</li><li>5. Touch START.</li></ol>	This mode lets you set the oven to pause between cycles for stirring, turning over or rearranging food, as well as for adding ingredients.
<b>Auto start</b>	<ol style="list-style-type: none"><li>1. Put in food and close the door.</li><li>2. Touch AUTO START.</li><li>3. Touch Number Pads for the time of day to start cooking.</li><li>4. Touch in the cooking time and Cook Power.</li><li>5. Touch START.</li></ol>	This mode lets you set the microwave oven to begin cooking at a specific time in the future up to 12 hours.



# Using Your Microwave Oven

## Microwave oven controls

There are three parts in the control section:

- Digital Display/Clock and Indicator Lights
- Command Pads
- Number Pads

Instructions for each control are covered on the following pages. Read them carefully.

When you first plug in the oven, a tone will sound, the display will show "0" and the colon will flash. If after you set the Clock (page 10-11), the Display again shows a "0", it means your electricity was off for a while. Reset the Clock.



### Digital display/clock and indicator lights

When you are not using the microwave oven, this is an accurate digital clock.

When you are using the microwave oven, it display time settings, temperature settings, and Indicator Lights.

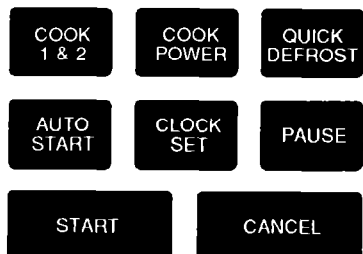

### Command pads

Touch Command Pads to tell the microwave oven what to do and in what order. A few examples:

- CLOCK SET tells the oven you are going to set the clock.
- START tells the oven to start.

(See page 10 for information on the tone you hear when touching any pad.)

Each Command Pad (except START, CANCEL, and CLOCK SET) lights an Indicator Light when you touch the Command Pad.

While the oven is running, an Indicator Light (or lights) will be on to show what the oven is doing.

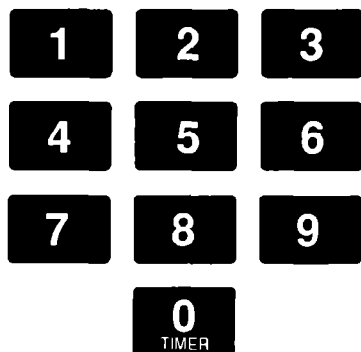

### Number pads

Once you've touched a Command Pad to tell the oven what you want it to do, you'll touch Number Pads to tell it . . .

- a time,
- a Cook Power.

## Audible signals

Audible signals are available to guide you when setting and using your oven. A programming tone will sound each time you touch a pad. Two beeps will sound between cycles. Three beeps signal the end of the Minute Timer function and a cook or defrost cycle. If you don't hear a tone, it is because of incorrectly entered instructions. For example, a tone will not sound if you touch a Number Pad before you touch a Command Pad.

## Setting the clock

When the oven is first plugged in, the Display shows “:0”. If the electric power ever goes off, the Display will again show “:0” when the power comes back on.

- You can cook without setting the clock.

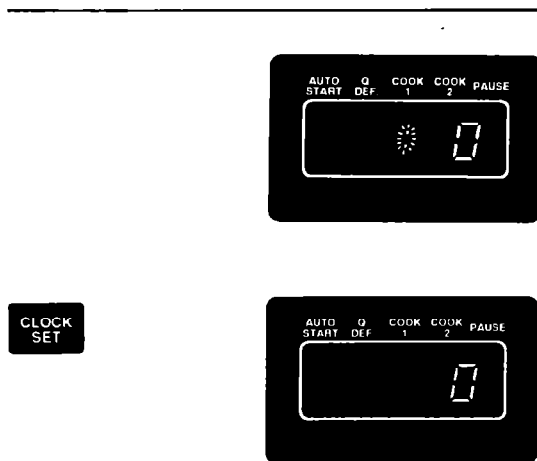

1. Touch **CLOCK SET** and the Display will show a “:0”.

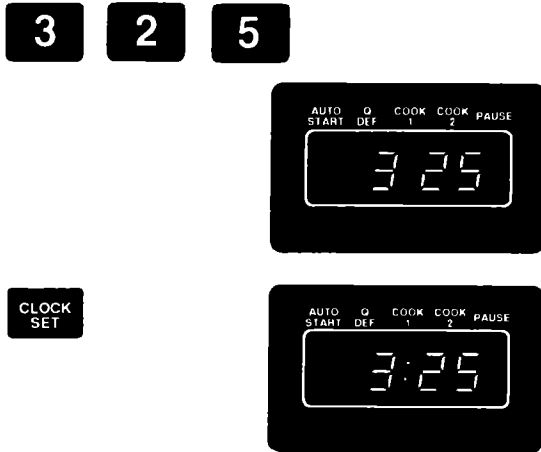

2. Touch Number Pads for the correct time of day. The Display will show what numbers you touched **in the order you touched them**. This example shows 3:25
3. Touch CLOCK SET. The Clock is set. If you have touched in an incorrect time, such as 12:65, 'E' will show on the Display and two beeps will sound. Touch CANCEL and then CLOCK SET and START over.

**NOTE:** To reset the clock, touch CLOCK SET. The current time will show on the Display and the colon will go off. Continue to set the clock as shown above.

## Cooking in your microwave oven

Be sure to read the microwave cooking information and recipes starting on page 36. They contain information about:

- What microwave energy is.
- How food is cooked by microwave energy.
- What affects cooking speed and cooking evenness.
- Safety tips.
- Utensils to use when cooking in a microwave oven.
- Cooking times for different foods.

### Important things to remember to get the best cooking results.

- ALWAYS cook food for the minimum recommended cooking time. If necessary, add time in one or two minute periods, then check for doneness to avoid overcooking the food.
- Stir, turn over or rearrange the food being cooked about halfway through the cooking time for most even doneness with all recipes.
- If a glass cover is not available, use waxpaper, paper towels or microwave approved plastic wrap. Turn back a corner to vent steam during cooking.
- Always cook food with Glass Tray in place.

COOK  
1&2

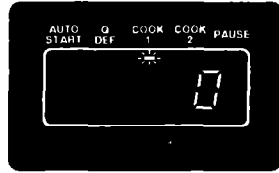

1

3

0  
TIMER

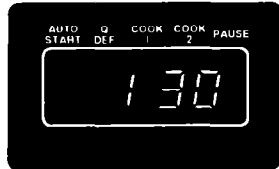

START

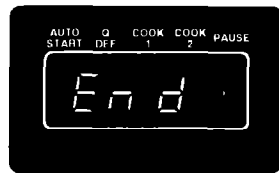

BEEP  
BEEP  
BEEP

## Cooking at high cook power

Follow these steps to cook at **HIGH power**:

1. Put food in the oven and close the door.
2. Touch COOK 1 & 2. The Cook 1 Indicator Light will blink and the Display will show 0.
3. Touch Number Pads for the cooking time you want. The Display will show the numbers you touched **in the order you touched them**. The example shows 1 minute, 30 seconds.
4. Touch START. The oven will automatically cook at HIGH Cook Power.

The Cook 1 Indicator Light will continue to blink to show that the oven is cooking in the first cycle. The Display counts down the time to show how much time is left in the first cycle.

When the cooking time ends, "End" will show on the Display and 3 beeps will sound. (You can stop the beeping by touching CANCEL.) The Display will then show the time of day.

## Cooking at lower cook powers

For best results, some recipes call for lower Cook Powers. The lower the Cook Power, the slower the cooking. Each Number pad also stands for a different percentage of Cook Power. Most recipes in this book tell you, by number, which Cook Power to use. Recipes in other books and magazines may tell you by name (HI, MED, LO, etc.) or percentage (10%, 50%, 80%, etc.).

The following chart gives the percentage of Cook Power each Number Pad stands for, and Cook Power name usually used:

automatic 100% of full power HIGH  
 9=90% of full power  
 8=80% of full power  
 7=70% of full power MED-HIGH  
 6=60% of full power  
 5=50% of full power MED  
 4=40% of full power  
 3=30% of full power MED-LOW  
 2=20% of full power  
 1=10% of full power LOW  
 0=TIMER (fan and light will be off)

1. Put food in the oven and close the door.
2. Touch COOK 1 & 2. The COOK 1 Indicator Light will blink and the Display will show 0.

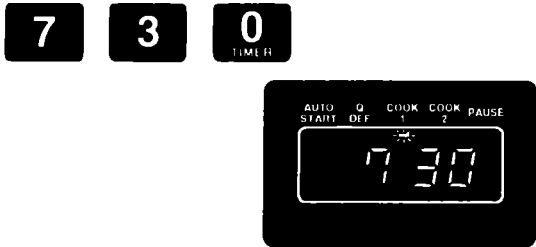
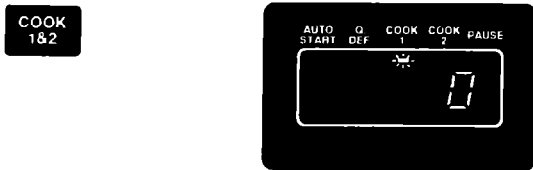

3. Touch Number Pads for the cooking time you want. The Display will show the numbers you touched **in the order you touched them**. This example shows 7 minutes, 30 seconds.

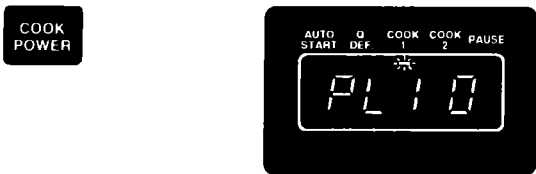

4. Touch COOK POWER. The Display will show "PL 10". This shows the oven is preprogrammed to cook at full (HIGH) power.

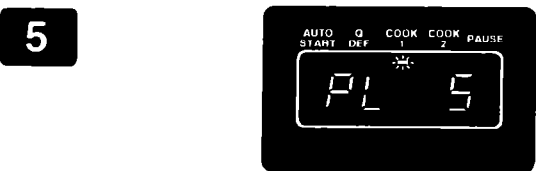

5. Touch a Number Pad for the Cook Power you want. The Display will show what you touched. This example shows you touched Number Pad 5 for 50% of full power.

## Using Your Microwave Oven Continued

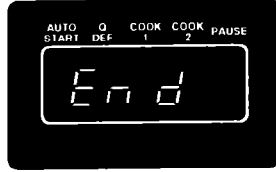

**BEEP  
BEEP  
BEEP**

6. Touch START. The COOK 1 Indicator Light will continue to blink to show that the oven is cooking in the first cycle at a Cook Power other than HIGH.

The Display counts down the time to show how much cooking time is left in the first cycle.

When the cooking time ends, "End" will show on the Display and 3 beeps will sound. (You can stop the beeping by touching CANCEL.) The Display will then show the time of day.

## Defrosting

Use QUICK DEFROST to thaw frozen food before cooking. For suggested defrost times, see the guide behind the oven door or the charts on pages 48 and 49.

1. Put frozen food in the oven and close the door.
2. Touch QUICK DEFROST. The QUICK DEFROST Indicator Light will blink and the Display will show 0.
3. Touch Number Pads for the defrosting time you want. The Display will show the numbers you touched **in the order you touched them**. This example shows 2 minutes, 30 seconds.
4. Touch START. The QUICK DEFROST Indicator Light will continue to blink to show that the oven is in the Quick Defrost cycle. The Display counts down the time to show how much defrosting time is left.

When the defrost time ends, "End" will show on the Display and 3 beeps will sound. (You can stop the beeping by touching CANCEL.) The Display will then show the time of day.

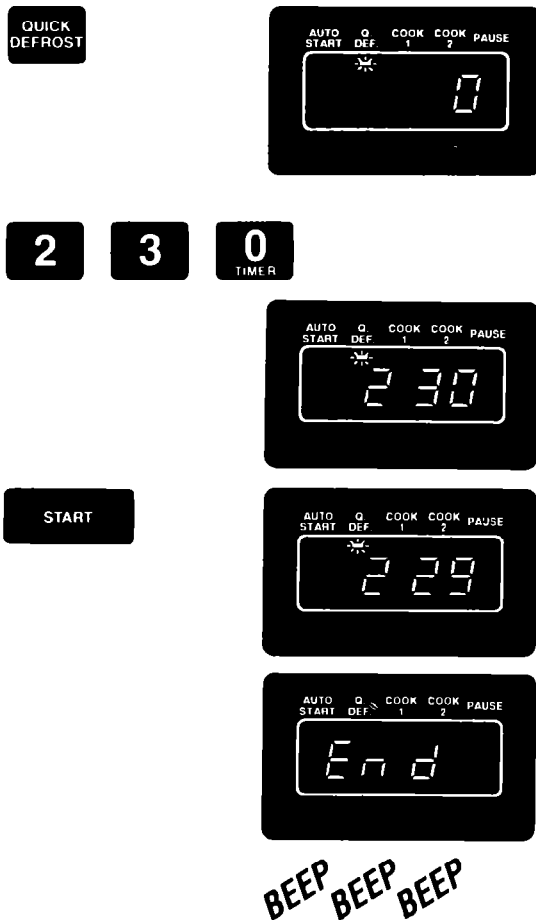

**Using Your Microwave Oven  
Continued**

**About the Quick Defrost cycle**

The microwave oven automatically divides the time set for the Quick Defrost cycle into three parts:

First part..... Full Cook Power  
Second part ..... 30% of full Cook Power  
Third parts ..... 0% of full Cook Power

This automatic step-down in Cook Power helps defrost food quickly and completely.

At the end of the Quick Defrost cycle check the food with a long-tined fork. If the center is hard frozen, set additional time using 20% Cook Power.



## Cooking automatically after defrosting

The controls can be set so the microwave oven goes automatically from defrosting to the Cook cycle you have touched in.

- Put food in the oven and close the door.
- Touch QUICK DEFROST. The QUICK DEFROST Indicator Light will blink and the Display will show 0.
- Touch Number Pads for the defrosting time you want. The Display will show the numbers you touched **in the order you touched them**. This example shows 2 minutes, 30 seconds.
- Touch COOK 1 & 2. The COOK 1 Indicator Light will blink and the Display will show 0.
- Touch Number Pads for the cooking time you want. The Display will show the numbers you touched **in the order you touched them**. This example shows 4 minutes, 30 seconds.
- Select a Cook Power. To cook at HIGH power, skip to Step 8. To select another Cook Power, touch COOK POWER. The Display will show "PL 10". This shows the oven is preprogrammed to cook at full (HIGH) power.
- Touch a Number Pad for the Cook Power you want. The Display will show what you touched. This example shows you touched Number Pad 6 for 60% of full power.

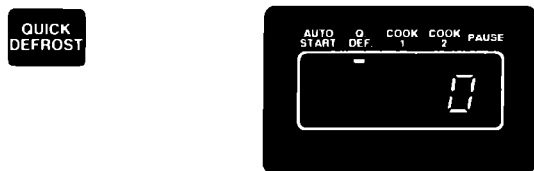

## Using Your Microwave Oven Continued

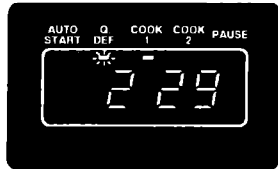

**BEEP BEEP**

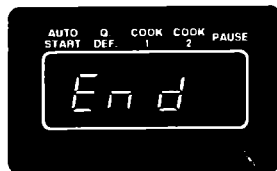
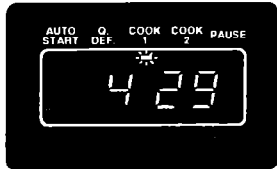

**BEEP BEEP BEEP**

8. Touch START. When you touch START, the QUICK DEFORST Indicator Light will blink and COOK 1 Indicator Light will stay on. The Display counts down the time to show how much time is left in the Quick Defrost cycle.

When the defrost time is over, you will hear 2 beeps and the Cook cycle will start.

The COOK 1 Indicator Light will blink during the Cook cycle.

The Display counts down the time to show how much time is left in the second cycle.

When the Cook cycle ends, "End" will show on the Display and 3 beeps will sound. (You can stop the beeping touching CANCEL.) The Display will then show the time of day.

## Cooking in more than one cook cycle

For best results, some recipes call for one Cook Power for a certain length of time, and another Cook Power for another length of time. Your oven can be set to change from one to another automatically.

1. Put food in the oven and close the door.
2. Touch COOK 1 & 2. The COOK 1 Indicator Light will blink and the Display will show 0.

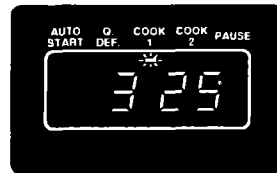
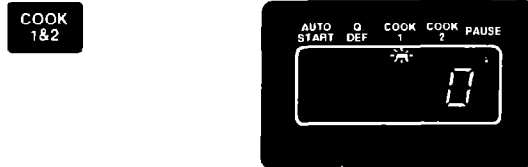

3. Touch Number Pads for the cooking time you want in the first cycle. The Display will show the numbers you touched **in the order you touched them**. This example shows 3 minutes, 25 seconds.

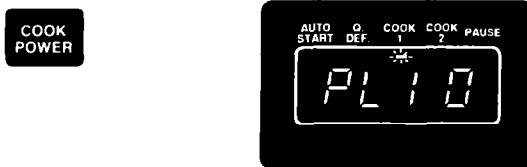

4. Select a Cook Power. To cook at HIGH power, skip to Step 6. To select another Cook Power, touch COOK POWER. The Display will show "PL 10". This shows the oven is preprogrammed to cook at full (HIGH) power.

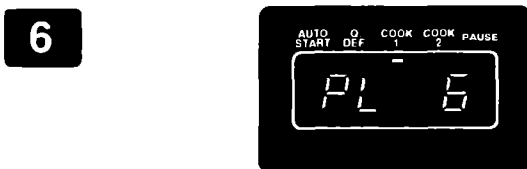

5. Touch a Number Pad for the Cook Power you want in the first cycle. The Display will show what you touched. This example shows you touched Number Pad 6 for 60% of full power.

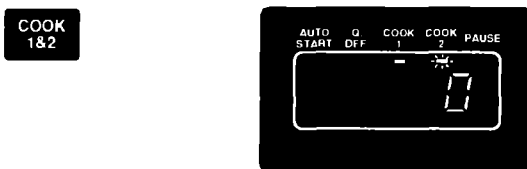

6. Touch COOK 2. The COOK 2 Indicator Light will blink and the Display will show 0.



7. Touch Number Pads for the cooking time you want in the second cycle. The Display will show the numbers you touched **in the order you touched them**. This example shows 4 minutes, 30 seconds.

**Using Your Microwave Oven  
Continued**

**COOK  
POWER**



**4**



**START**



**BEEP BEEP**

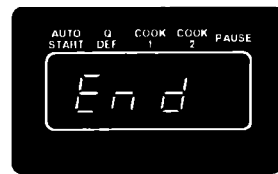

**BEEP BEEP BEEP**

8. Select a Cook Power. To cook at HIGH power, skip to Step 10. To select another Cook Power, touch COOK POWER. The Display will show "PL 10". This shows the oven is preprogrammed to cook at full (HIGH) power.

9. Touch a Number Pad for the Cook Power you want in the second cycle. The Display will show what you touched. This example shows you touched Number Pad 4 for 40% of full power.

10. Touch START. When you touch START, the COOK 1 Indicator Light will blink while the oven is cooking in the first cycle. COOK 2 Indicator Light will stay on.  
The Display counts down the cooking time to show how much time is left in the first cycle.  
You will hear 2 beeps at the end of the COOK 1 cycle.

The COOK 2 Indicator Light will blink during the second cycle.  
The Display counts down the time to show how much time is left in the second cycle.

When the COOK 2 cycle ends, "End" will show on the Display and 3 beeps will sound. (You can stop the beeping by touching CANCEL.) The Display will then show the time of day.

**Hints for cooking with more than one cycle**

You can program the cooking cycles in any order. However, when the microwave oven is started, it will automatically go through the cycles in the order of the examples described in this book. For example, if you program COOK 1, and QUICK DEFROST, the microwave oven will automatically follow this sequence: QUICK DEFROST → COOK 1.

## Using PAUSE

For best results, some recipes call for stirring, turning over or rearranging food, or for adding ingredients during cooking. Your microwave oven can be set to pause between COOK 1 and COOK 2 or between QUICK DEFROST and a following cycle.

This gives you time to stir (casseroles), turn over (meat) or rearrange (potatoes) food, or to add ingredients.

1. Put for in the oven and close the oven door.
2. Touch in the desired cooking instructions for COOK 1, (see page 19).
3. Touch PAUSE. The COOK 1 Indicator Light will blink and the Display will show "PAUS".
4. Touch in the desired cooking instructions for COOK 2, (see page 19).

5. Touch START. The Display will show the time you selected for Cook 1.

When Cook 1 is over, 2 beeps will sound and the oven will shut off. The Display will show "PAUS". The COOK 2 Indicator Light will stay on.

Open the door, stir, turn over or rearrange the food or add ingredients. Close the door. Touch START to continue with Cook 2.

**NOTE:** The oven will remain off until you touch START.

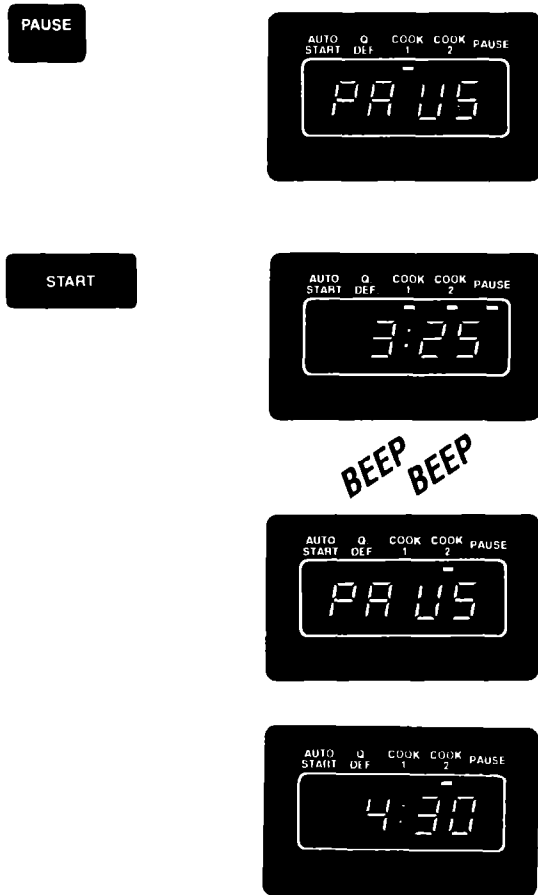

## Using the Minute Timer

The microwave oven controls can be used as a minute timer. Use COOK 1 at "0" Cook Power for timing up to 99 minutes, 99 seconds.

**NOTE:** The oven will not operate while the Minute Timer is in use.

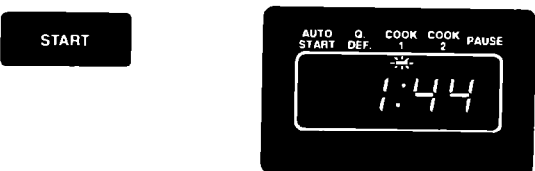
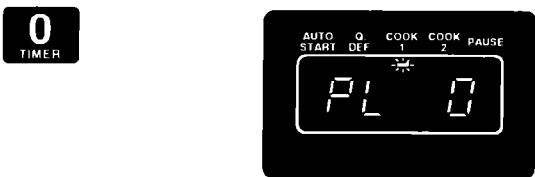
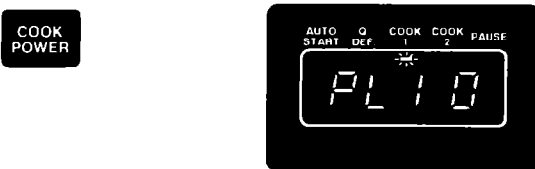
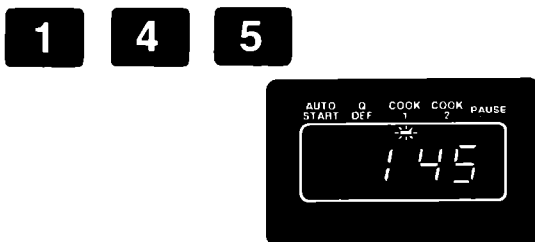
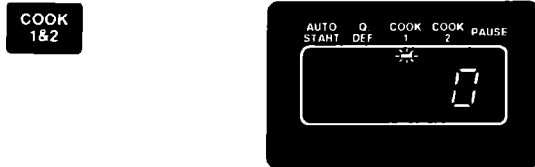

1. Touch COOK 1 & 2. The COOK 1 Indicator Light will blink and the Display will show 0.

2. Touch Number Pads for the minutes and seconds you want. The Display will show the numbers you touched **in the order you touched them**. This example shows 1 minutes, 45 seconds.

3. Touch COOK POWER. The Display will show "PL 10".

4. Touch the "0" Number Pad. The Display will show "PL 0". This tells you that the oven will be operating at 0% power.

5. Touch START.

**NOTE:** If you hear the fan start when you touch START, you have not set the oven properly. Touch CANCEL and start over.

The COOK 1 Indicator Light will blink to show you that the timer is running.

The Display counts down to show you how much time is left. During the countdown the oven will be dark and the fan will be off.

## Using Your Microwave Oven Continued

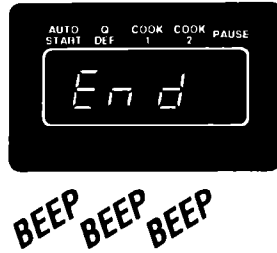

When the set time ends, "End" will show on the Display and 3 beeps will sound. (You can stop the beeping by touching CANCEL.) The Display will then show the time of day.

**NOTE:** Opening the oven door stops the countdown. Close the door and touch START to continue the timing countdown.

## Using Auto Start

The microwave oven can be set to start automatically at a specific time in the future up to 12 hours.

1. Put in food and close the door. (See WARNING on page 25.)
2. Touch AUTO START. The AUTO START Indicator Light will blink.
3. Touch Number Pads for the time of day to start cooking. A preset delay time must be less than 12 hours.
4. Touch in the cooking time and Cook Power.
5. Touch START. The present time of day will show in the display window the Auto Start indicator will blink and the COOK 1 indicator will stay on. As soon as the clock shows the preset cook start time, the oven will start cooking and the Display will count down the set time.

**NOTE:** If you hear the fan start when you touch START, you have not set the oven properly. Touch CANCEL and start over.

### Additional information

- AUTO START must always be used after time of day is set.
- If you want to change the Auto Start time during Auto Start operation, touch the PAUSE and the AUTO START again, and then follow the steps 3 to 5.



**⚠ WARNING**

To avoid sickness and food waste when using delay start or auto start;

- Do not use foods that will spoil while waiting for cooking to start, such as dishes with milk or eggs, cream soups, and cooked meats or fish. Any food that has to wait for cooking to start should be very cold or frozen before it is put in the oven. **MOST UNFROZEN FOODS SHOULD NEVER STAND MORE THAN TWO HOURS BEFORE COOKING STARTS.**
- Do not use foods containing baking powder or yeast when using delay start. They will not rise properly.
- Do not allow food to remain in oven for more than two hours after end of cooking cycle.

**Other operating hints**

To stop the oven while it is running:

1. Open the door. The oven will stop. To restart the oven, close the door and touch START.
2. Touch CANCEL. All instructions will be erased. You must touch in new instructions.
3. If you touch two instructions into the same cycle, the second set of instructions will cancel the first.

# Installation Instructions

Before you begin, carefully read the following instructions.

## Installing your microwave oven

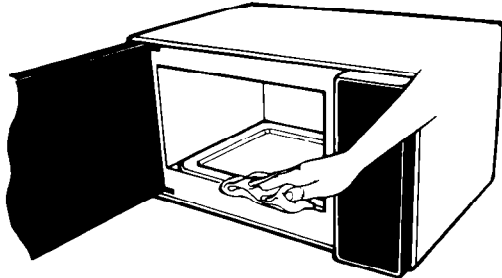

1. Empty the microwave oven and clean inside it with a soft, damp cloth. Check for damage such as misaligned door, damage around the door or dents inside the oven or on the exterior. If there is any damage, please do not operate the unit if it has been checked by an authorized Whirlpool<sup>SM</sup> service technician and any repairs made.

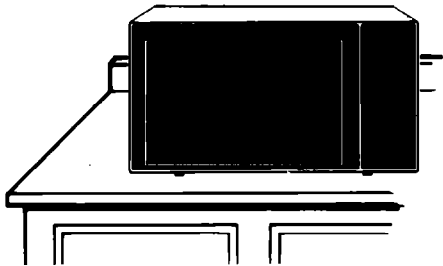

2. Put the oven on a cart, counter, table or shelf that is strong enough to hold the oven and the food and utensils you put in it. **(The control side of the unit is the heavy side. Use care when handling.)** The weight of Model MS1650XW is approximately 25.3 lbs (10.5 kg). The weight of Model MS1451XW is approximately 23.1 lbs (10.4 kg).

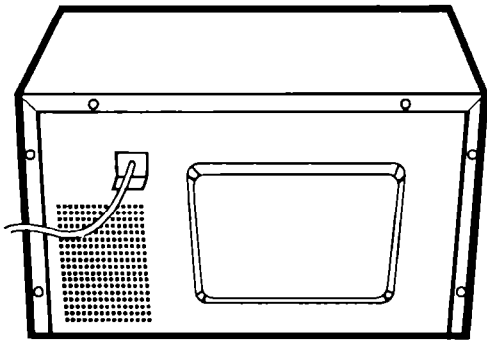

3. **Do not block the rear air intake opening.** Blocking the air intake opening can cause damage to the oven and poor cooking results. Make sure the microwave oven legs are in place to ensure proper air flow.

### **⚠ CAUTION**

**Do not install the oven next to a conventional surface unit or in any area where excessive heat and steam are generated. This could damage the outside of the cabinet.**

#### 4. Electrical requirements

Observe all governing codes and ordinances. A 120 Volt, 60 Hz, AC only, 15 or 20 amp fused electrical supply is required. (Time-delay fuse is

recommended.) It is recommended that a separate circuit serving only this appliance be provided.

### 5. GROUNDING INSTRUCTIONS

#### ⚠ WARNING

#### Electrical Shock Hazard

Improper use of the grounding plug can result in a risk of electrical shock. **DO NOT, UNDER ANY CIRCUMSTANCES, REMOVE THE POWER SUPPLY CORD GROUNDING PRONG.**

6. For your personal safety, this appliance must be grounded. In the event of an electrical short circuit, grounding reduces the risk of electrical shock by providing an escape wire for the electric current. This appliance is equipped with a polarized 3-prong grounding plug. It must be plugged into a correctly polarized mating 3-prong grounding type wall receptacle, properly installed and grounded in accordance with the National Electrical Code and local codes and ordinances. If a mating wall receptacle is not available or if you are not sure if the wall receptacle is properly grounded and polarized, have it checked by a qualified electrician.

It is personal responsibility and obligation of the customer to have a properly grounded and correctly polarized 3-prong wall receptacle installed by a qualified electrician.

Consult a qualified electrician if the grounding instructions are not completely understood, or if doubt exists as to whether the appliance is properly grounded.

**It is not recommended to use an extension cord with your microwave oven, but if you find it necessary to do so temporarily (until a properly grounded and polarized 3-prong receptacle is installed), use only a heavy duty UL listed 3-wire grounding type extension cord containing three 16-gauge (minimum) copper wires.** It must not be longer than 10 feet (cords longer than 10 feet may affect the cooking performance of your microwave oven). The plug on the extension cord must fit into a 3-prong grounding type wall receptacle (as shown on this page) and the receptacle end of the extension cord must accept the 3-prong grounding plug of the microwave oven.

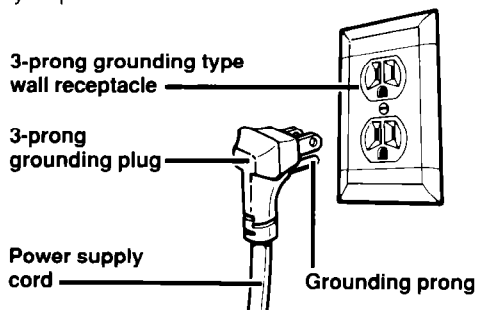

7. To test the oven, plug it into the proper electrical outlet. Put about one cup (250 mL) of cold water in a glass container in the oven.

Close the door. Make sure it latches. Follow the directions on page 12 to set the oven to COOK for 2 minutes. When the time is up, the water should be heated.

8. **This microwave oven is designed for use in the household only and must not be used for commercial purposes.**

**Do not** remove the door, control panel or cabinet at any time. The unit is equipped with high voltage and should not be serviced unless by an authorized Whirlpool<sup>SM</sup> service technician.

**- SAVE THESE INSTRUCTIONS -**

## Custom mounting your microwave oven

Your microwave oven is not limited to carts, counters or tables. Custom installations are made easy with kits available from your dealer.

1. Attach the microwave oven directly to the underside of a cabinet.

4158693 or 4158694

Under-the-Cabinet Mounting Kit

**Do not install the oven next to or over a conventional surface unit or in any area where excessive heat and steam are generated. This could damage the microwave oven.**

## Caring for your microwave oven

### Cleaning the microwave oven



Wipe often with warm sudsy water and a soft cloth or sponge. The glass tray may be removed for cleaning. Wash by hand in mild detergent or in dishwasher. Do not operate the microwave oven when the glass tray is removed for cleaning.

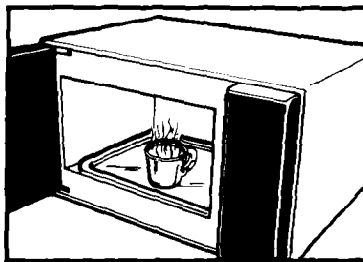

For stubborn soil, boil a cup of water in the oven for 2 or 3 minutes. Steam will soften the soil.



**Be sure to keep the areas clean where the door and oven frame touch when closed.** Use only mild, non-abrasive soaps or detergents applied with a sponge or soft cloth when cleaning surfaces of door and oven that come together. Rinse well.

### **⚠ CAUTION**

Abrasive cleansers, steel wool pads, gritty wash clothes, etc., can damage the control panel, and the interior and exterior oven surfaces. Use a soft cloth or a sponge with a mild detergent or spray glass cleaner.

# How Your Microwave Oven Works

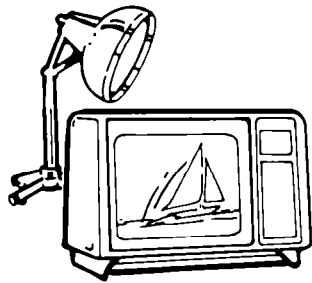

Microwave ovens are safe. Microwave energy is not hot. It causes food to make its own heat, and it's this heat that cooks the food.

Microwaves are like TV waves or light-waves. You can't see them but you can see what they do.

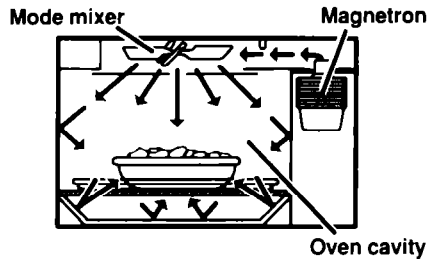

A magnetron in the microwave oven produces microwaves. The microwaves move into the oven where they are scattered or stirred by a mode mixer (like a fan). Microwaves bounce off metal oven walls and are absorbed by food.

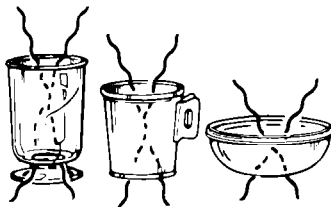

Microwaves pass through glass, paper and most plastics without heating them so food absorbs the energy. Microwaves bounce off metal pans so food does not absorb the energy.

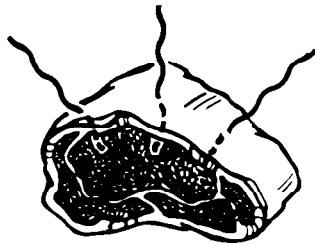

Microwaves may not reach the center of a roast. The heat around the outside is what cooks the roast all the way through. This is one of the reasons for letting some foods (roasts, baked potatoes) stand for a while after cooking, or for stirring some foods during the cooking time.

The microwaves disturb water molecules in the food. As the molecules bounce around bumping into each other, heat is made, like rubbing your hands together. This is the heat that does the cooking.

# Operating Safety Precautions

## **⚠ WARNING**

To reduce the risk of fire, electrical shock, injury to persons, or damage when using the microwave oven, follow the precautions on pages 30-33.

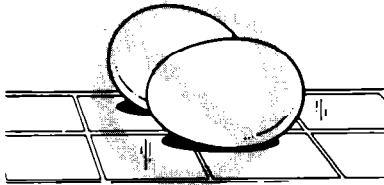

**Never cook or reheat a whole egg.** Steam build-up in whole eggs may cause them to burst and burn you, and possibly damage the oven. Slice hard boiled eggs before heating. In rare instances, poached eggs have been known to explode. Cover poached eggs and allow a standing time of one minute before cutting into them.

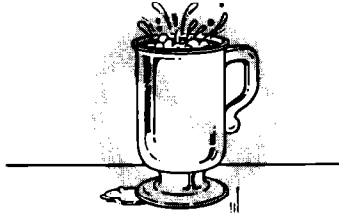

Liquids heated in certain containers (especially cylindrical-shaped containers) may become overheated. The liquid may splash out with a loud noise during or after heating or when adding ingredients (coffee, etc.) resulting in harm to the oven and possible personal injury. For best results stir any liquid several times before heating or reheating.

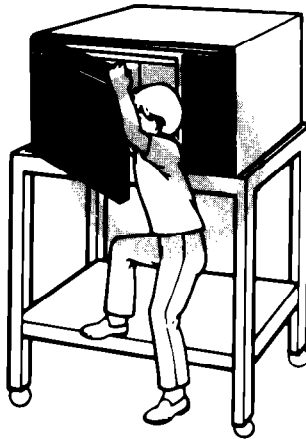

**Never** lean on the door or allow a child to swing on it when the door is open. Injury could result.

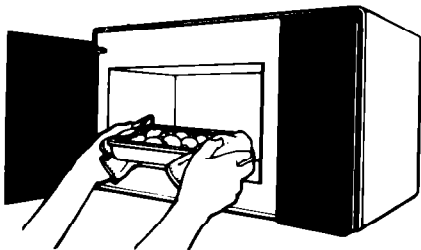

**Use hot pads.** Microwave energy does not heat containers, but the hot food does.

**Do not** heat, store or use flammable materials in or near the oven. The fumes can create a fire hazard or explosion.

**Do not** do canning of foods in the oven. Closed glass jars may explode resulting in damage to the oven or possible personal injury.

**Do not** use the oven to sterilize objects (baby bottles, etc.). It is difficult to maintain the high temperature required for safe sterilization.

**Do not** deep fry in the oven. Microwavable utensils are not suitable and it is difficult to maintain appropriate deep frying temperatures.

**Do not** use the oven for storage. Do not leave paper products, books or cooking utensils in the oven when not in use. Fire may result if someone accidentally starts the oven.

**Do not** let food or containers touch the top or sides of the oven.

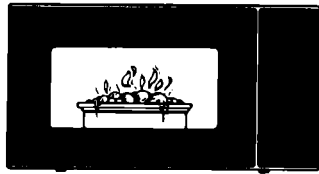
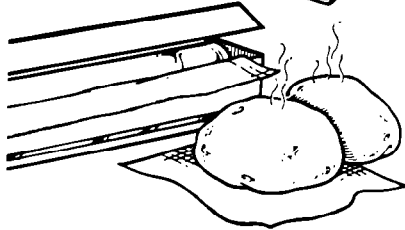
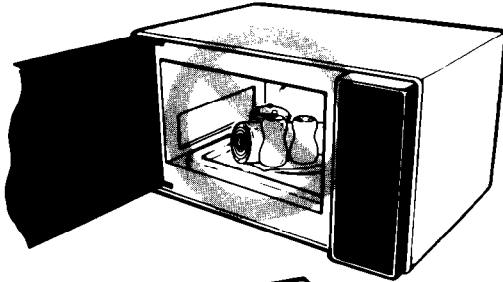

**Do not overcook potatoes.** Fire could result. At the end of the recommended cooking time they should be slightly firm.

Wrap in foil and set aside for 5 minutes. They will finish cooking while standing.

If a fire should start in the oven cavity:

- **do not open oven door**
- **turn oven off**
- **unplug the oven or turn off the power at the main power supply.**

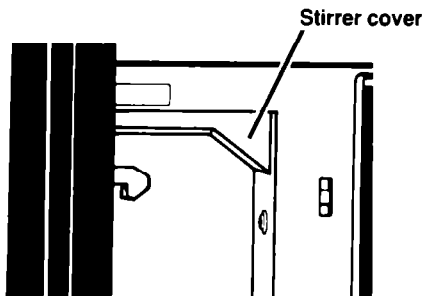

**Never** remove the stirrer cover. The plastic cover protects the microwave stirrer blade from soil or bending.

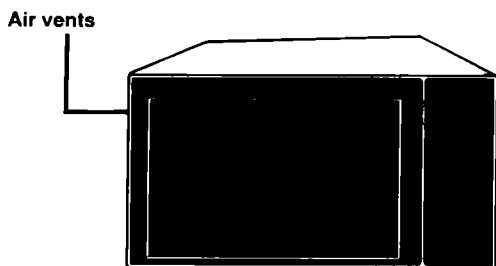

**Do not** place anything within five inches of the left side of the oven. Damage to the oven may result.

**Operating Safety Precautions  
Continued**

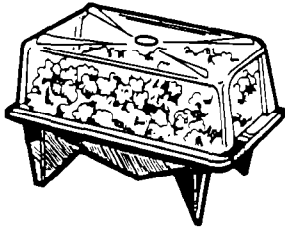

**Do not** pop popcorn, except in a microwave approved popcorn popper or commercial package designed especially for microwave ovens. Follow directions supplied with the popper.

**Never** try to pop popcorn in a paper bag. Overcooking may result in smoke and fire.

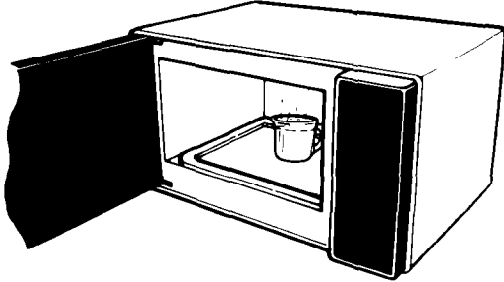

Starting a microwave oven when it's empty is not recommended.

If you experiment, put a container of water in the oven.

It is normal for the inside of the oven door to lock wavy after the oven has been running for a while.

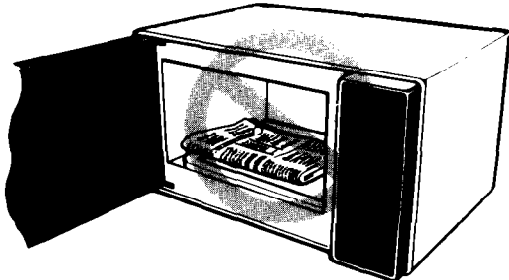

**Do not** use newspaper or other printed paper in the oven. Fire could result.

**Do not** dry flowers, fruit, herbs, wood, paper, gourds or clothes in the oven. Fire could result.

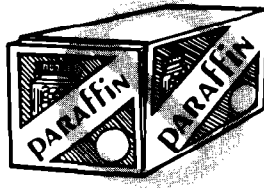

**Do not** try to melt paraffin wax in the oven. You may be burned because paraffin wax will not melt.

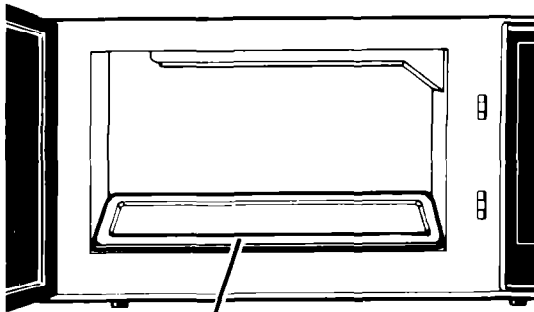

Glass Tray

## Glass Tray

Do not operate the microwave oven unless the glass tray is securely in place.

**Carefully** place cookware on glass tray to avoid possible breakage.

**Handle glass tray with care** when removing from oven to avoid possible breakage.

When a browning dish is used, the browning dish bottom must be at least 3/16 inch above the glass tray.



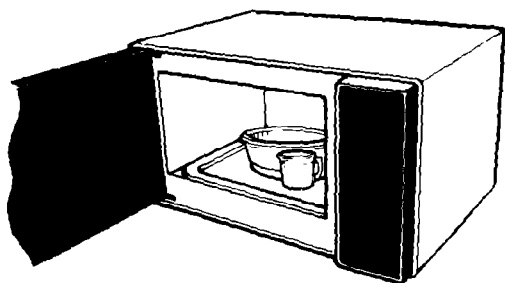
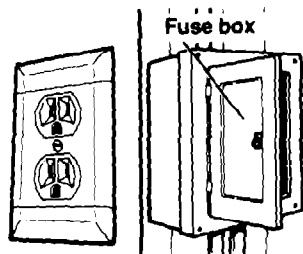

## General information

If your electric power line or outlet voltage is less than the normal 120 volts, cooking times may be longer.

**To test a dish for safe use, put it into the oven with a cup of water beside it. Cook on HIGH Cook Power for one minute. If the dish gets hot and water stays cool, do not use it.**

# If You Need Service Or Assistance . . .

## We suggest you follow these steps:

### 1. Before calling for assistance . . .

Performance problems often result from little things you can find and fix without tools of any kind.

#### If nothing operates:

- Is the power supply cord plugged into a live circuit with the proper voltage? (See Installation Instructions.)
- Have you checked your home's main fuses or circuit breaker box?
- Have you checked the electric company for a power failure?

#### If the microwave oven will not run:

- Is the oven being used as a timer?
- Is the door firmly closed and latched?
- Did you touch START?
- Did you follow the directions exactly?

#### If the microwave cooking times seem too long:

- Is the electric supply to your home or wall outlets low or lower than normal? Your electric company can tell you if the line voltage is low. Your electrician or service technician can tell you if the outlet voltage is low.
- Is the Cook Power at the recommended setting?
- Are you allowing for more time when cooking more food at one time?

#### If the Display shows a time counting down but the oven is not cooking:

- Is the oven door closed completely?
- Have you set the controls as a minute timer?

#### If you do not hear the programming tone:

- Is the command correct?

#### If the fan seems to be running slower than usual:

- Has the oven been stored in a cold area? The fan will run slower until the oven warms up to normal room temperature.

#### If there has been a power interruption, the Display will show 0. Reset the clock. (See page 11.)

**2. If you need assistance\*...  
Call Whirlpool COOL-LINE® service assistance  
telephone number. Dial free from anywhere in  
the U.S.:**

**1-800-253-1301**

and talk with one of our trained consultants. The consultant can instruct you in how to obtain satisfactory operation from your appliance, or if service is necessary, recommend a qualified service company in your area.

If you prefer, write to:  
Mr. Donald Skinner  
Director of Consumer Relations  
Whirlpool Corporation  
2000 M-63  
Benton Harbor, MI 49022

Please include a daytime phone number in your correspondence.

**3. If you need service\*...**



Whirlpool has a nationwide network of authorized Whirlpool<sup>SM</sup> service companies. Whirlpool service technicians are trained to fulfill the

product warranty and provide after-warranty service, anywhere in the United States. To locate the authorized Whirlpool service company in your area, call our COOL-LINE® service assistance telephone number (see Step 2) or look in your telephone directory Yellow Pages under:

**APPLIANCES-HOUSEHOLD-  
MAJOR-SERVICE & REPAIR**

**ELECTRICAL APPLIANCES-  
MAJOR-REPAIRING & PARTS**

OR

**WASHING MACHINES, DRYERS  
& IRONERS-SERVICING**

**WHIRLPOOL APPLIANCES  
AUTHORIZED WHIRLPOOL SERVICE**

*SERVICE COMPANIES*  
XYZ SERVICE CO.  
123 MAPLE . . . . . 999-9999

**4. If you are not satisfied with how the  
problem was solved\*...**

- Contact the Major Appliance Consumer Action Panel (MACAP). MACAP is a group of independent consumer experts that voices consumer views at the highest levels of the major appliance industry.
- Contact MACAP only when the dealer, authorized servicer or Whirlpool have failed to resolve your problem.  
Major Appliance Consumer  
Action Panel  
20 North Wacker Drive  
Chicago, IL 60606
- MACAP will in turn inform us or your action.

\* When requesting assistance, please provide: model number, serial number, date of purchase, and a complete description of the problem. This information is needed in order to better respond to your request.

# MICROWAVE COOKING RECIPES AND TABLES

---

## Introduction

Your microwave oven can be one of the most useful appliances in your home. If you follow a few basic instructions, this book will teach you how to make microwave cooking both enjoyable and safe. All of the recipes in this book have been tested and proven to provide many rewarding meals for you and your family. Before you begin trying the recipes, take a few moments to read these pages of instructions and helpful hints.

**How Your Microwave Oven Works:** Microwaves are a form of energy, just as sunlight and radio waves. The only difference is in the shape and form of the energy wavelengths. When the magnetron tube in your oven is activated, electricity is converted into high frequency radiating energy in the form of very small (micro) waves. The microwaves are released into the oven compartment through an opening in the top of the appliance, and are distributed evenly by a built-in stirrer. When microwaves penetrate food, individual molecules in the food begin to vibrate, and the heat friction caused by this vibration passes from molecule to molecule by induction, cooking the food.

**Power and Standing Time:** Like any conventional oven, microwave appliances are affected by fluctuations in local energy supplies. The location of your house, weather, and time of day may all affect energy availability, and thereby vary the rate at which your microwave oven cooks. This book provides you with minimum and maximum cooking times for each recipe to accommodate this possible variation in energy availability.

In order to avoid overcooking, you should always check your food as soon as it has cooked the minimum recommended time. Remember also that cooking continues after the food has been taken from the oven. This period of extra cooking occurs because the molecules continue to vibrate after the food has been removed from the source of cooking energy.

Standing times, which allow the extra cooking to take place, can vary from one to five minutes for vegetables, or five to ten minutes for a large roast. Experience will help you determine standing times for the various foods you prepare.

## Utensils

Never use metal or metal-trimmed utensils in your microwave oven. Microwave cannot penetrate metal. They will bounce off any metal object in the oven—just as they bounce off the metal walls of the oven and cause "arcing", a phenomenon that resembles lightning. Many of the containers which you already own are perfectly safe to use.

**How to Test for Microwave Use:** Here is a simple test to determine whether or not a utensil is compatible with your microwave oven: Measure one cup of water into a glass container, and place it on or near the dish you wish to test. Turn microwave on at High Power for one minute, until water is hot, then test the container in question. If the dish remains cool to the touch, it is safe for microwave oven use.

**Utensils to Use in a Microwave Oven:** Containers made of glass, ceramics, and some forms of paper and plastic, allow microwaves to pass freely through them, making them ideal for microwave use. Boilable pouches and oven baking bags are usually equally effective in your microwave oven.

Many utensils are made especially for use in a microwave oven. These heat-resistant plastics may go directly from freezer to microwave and vice versa without harming either food or container. To avoid problems, always read the instructions on these containers before using them.

**Shape and Depth:** Depth and shape of containers will affect cooking time. In a shallow casserole dish, for example, food cooks more rapidly than in a deep dish with the same volume, because more surface area of the food is exposed to microwave energy. Straight-sided containers are preferable to curved ones, because the more uniform food depth allows for even cooking. Round dishes allow the microwaves to penetrate the food evenly from all sides. Square dishes allow excess exposure of the food to microwaves, often resulting in overcooking.

## Food Characteristics and Your Microwave

Many people believe that their job is done once the food goes into the microwave and the timer is set. This is far from true. The following techniques are as important to your cooking as selecting quality ingredients from the market.

**Density:** Microwaves penetrate porous foods such as cakes or breads more easily than heavy foods such as roasts or casseroles. Dense foods must be cooked for a longer time, and often at a lower power setting to avoid uneven cooking.

**Starting Temperatures:** The initial temperature of food directly affects the length of time they must cook or heat. As in a conventional oven, frozen food takes longer to cook than does refrigerated food, while food at room temperature cooks most quickly.

**Moisture Content:** Because microwaves are attracted to moisture, cooking time will vary according to water content. Naturally moist foods such as vegetables, fish and poultry will cook quickly and evenly; drier foods such as rice or dried beans require added moisture for microwave cooking.

**Size of Foods:** Small, even-sized pieces of food cook more rapidly than large ones. To ensure even cooking, cut all pieces of food into similar sizes and shapes.

**Quantity of Foods:** Microwave times relate directly to the amount of food being cooked. Smaller quantities of food cook faster than large quantities. When doubling a recipe, increase time by about half and check for doneness. Add any additional time very cautiously.

**Shape of Foods:** Thin parts of uneven foods cook faster than thick parts. Chicken pieces, fish fillets and other foods which vary in thickness will take longer to cook in the thicker portions. To promote even cooking, arrange foods so that thicker portions are to the outside, where they will absorb more energy.

**Bones and Fat Content in Meat:** The bone and fat distribution affects how evenly meats cook in the microwave oven. Boneless cuts cook more evenly, since bones conduct heat to areas near them. Well-marbled meat cooks more evenly. Large areas of fat attract energy away from the meat, and slow cooking. To prevent uneven cooking, meats with bones or large fatty areas may require frequent turning during microwaving.

## Techniques for Microwave Cooking

Every different food has unique characteristics. Here are some ideas and guidelines to help you achieve optimum results from your microwave oven.

**Elevating:** As in conventional cooking, foods such as roasts are elevated so they are not allowed to steam in their own juices. Turning foods is especially important here because it allows for more even cooking. Shielding may also be needed to prevent overcooking in some smaller areas.

**Stirring:** As with other cooking methods, prevent uneven cooking by stirring and rearranging food while it is cooking. Since the food towards the outside of a dish heats first, stir from the outside toward the center to promote even heat distribution.

**Browning:** Many microwave utensils are specially designed to allow browning of some foods. A special coating on the bottom of these dishes absorbs microwave energy to create temperatures high enough to brown food such as hamburgers, fried eggs, and grilled sandwiches. Use these utensils according to manufacturer's instructions.

**Shielding:** Certain foods that attract excess microwave energy, such as wing tips and leg ends of poultry, and the corners of square baking pans, can be shielded to prevent overcooking. Shielding done with small pieces of foil will not hurt your oven as long as they do not touch each other or the sides of the oven.

**Arranging and Spacing:** Individual foods like potatoes and muffins should be arranged in a circle at the outside edge of the oven cooking platform. This will guarantee that all the pieces cook evenly at the same rate. Foods which are uneven in thickness, such as chicken wings, should be arranged with the meatier portions to the outside. Delicate foods like asparagus tips should be placed toward the inside of the dish to receive less microwave energy. If possible, always leave spaces between individual pieces of food.

## Cooking Frozen Foods

Frozen food requires extra care when being prepared in a microwave because most package instructions are based on a certain oven. Know the output power of your particular oven. If your oven is of a different wattage than that stated on the packet, adjustments to the cooking times will be required. INCREASE the cooking time in 1 minute increments. Where possible stir each time then leave to stand for at least 3 minutes.

## Tips on Reheating Food

- Arrange foods for reheating on the plate so that the thicker, denser and meatier portions are to the outer edge of the dish, where they will receive the maximum amount of energy, and the thinner areas to the center where they will get less.
- When plating up meals for reheating, try to ensure that the food is arranged in an even layer.
- Cover foods when reheating with a layer of pricked cling film to retain moisture.

- When reheating, observe the standing time recommended in cooking procedures to make maximum use of the microwave energy and to prevent overcooking of the reheated dish.
- The times in the reheating chart refer to foods at room temperature. Allow extra time if the food is refrigerated or frozen.
- When reheating potatoes in their jackets, breads pastries or moist foods, place them on a sheet of absorbent paper towel so that it may absorb the moisture during the reheating time.
- If you are in any doubt about a food losing moisture during reheating, wrap it in a tight skin of cling film, piercing the cling film in a couple of places.
- Stir foods regularly during the reheating process. If stirring is not possible, then rotate the food or dish or re-arrange during the reheating time.

**THIS APPLIANCE SHOULD NOT BE USED  
FOR COMMERCIAL CATERING PURPOSES.**

# APPETIZERS, SOUPS AND SANDWICHES

## Vegetable Platter

12 frozen baby carrots, defrosted  
 12 frozen Brussels sprouts, defrosted  
 12 whole canned mushrooms  
 24 whole boiled onions  
 12 wooden skewers, 6-inch  
 1 medium head cauliflower, about  
 1½ lbs.

### Lemon Dill Sauce

⅓ cup butter or margarine  
 1 tablespoon lemon juice  
 ½ teaspoon seasoned salt  
 ¼ teaspoon dried dill weed

Assemble kabobs by alternating 1 carrot, 1 brussels sprout, 1 mushroom and 2 onions on each skewer. Arrange in circular pattern on 10-inch microwavable round plate. Set aside.

Rinse cauliflower with water. Shake off excess. Wrap in plastic wrap. Microwave at High Power for 4 minutes. Turn over. Microwave for 5 to 6 minutes, or until tender-crisp. Set aside.

In 2-cup glass measure, combine all sauce ingredients. Microwave at High Power for 1½ to 2 minutes, or until butter melts. Mix well. Brush kabobs with sauce. Cover with vented plastic wrap.

Microwave at High Power for 5 to 6 minutes, or until vegetables are tender-crisp. Let stand 1 minute. Remove plastic wrap from all vegetables. Place cauliflower in center of plate. Brush with remaining sauce. Serve hot.

10 to 12 servings

## Chili Cheese Dip

1 lb. pasteurized process cheese  
 spread with Mexican seasoning  
 1 can (15 oz.) chili without beans  
 1 can (5 oz.) evaporated milk  
 1 medium tomato, seeded and  
 chopped  
 2 green onions, sliced corn chips

Cut cheese into 1-inch cubes. In 2-quart microwavable casserole, combine cheese, chili and milk. Cover. Microwave at Power Level 7 for 12 to 14 minutes, or until cheese melts. Stir every 3 minutes. Let stand 2 minutes. Top with tomato and onions. Serve with corn chips.

About 4 cups

## Cream of Vegetable Soup

1 pkg. (10 oz.) frozen mixed  
 vegetables  
 ¼ cup chopped onion  
 2 tablespoons butter or margarine  
 1 tablespoon snipped fresh parsley  
 2 teaspoons instant chicken bouillon  
 granules  
 ¼ teaspoon dried marjoram leaves  
 ⅓ teaspoon pepper  
 1 cup water  
 2 tablespoons all-purpose flour  
 1 cup half-and-half or milk  
 Cheese-flavored croutons

In 2-quart microwavable casserole, combine mixed vegetables, onion, butter and parsley. Cover. Microwave at High Power for 9 to 10 minutes, or until tender, stirring once.

Pour mixture into blender container or food processor. Blend until smooth. Return mixture to casserole. Stir water into flour. Add bouillon, marjoram and pepper. Blend water mixture and half-and-half into vegetable purée. Microwave, uncovered, at High Power for 4 to 5 minutes, or until mixture thickens, stirring once. Garnish with croutons.

4 to 6 servings

## Ham and Vegetable Soup

---

**3/4 to 1 lb. fully-cooked bone-in ham slice**  
**1 tablespoon olive oil**  
**8 oz. small red potatoes, thinly sliced**  
**1 small zucchini, sliced**  
**1 cup chopped cabbage**  
**1/2 cup chopped onion**  
**1/3 cup chopped green pepper**  
**1/4 cup chopped carrot**  
**4 to 4 1/2 cups hot water**  
**2 teaspoons instant chicken bouillon granules**  
**1/4 teaspoon dried basil leaves**  
**1/8 teaspoon dried thyme leaves**  
**1/8 teaspoon pepper**

Remove bone from ham. Set aside. Cut ham into 1/2-inch cubes. Set aside. In 3-quart casserole, combine ham bone, potatoes, zucchini, cabbage, onion, green pepper, and carrot. Cover.

Microwave at High Power for 10 to 12 minutes, or until tender, stirring once. Stir in ham and remaining ingredients. Re-cover. Microwave at High Power for 15 to 18 minutes, or until heated through, stirring once. Discard bone.

6 to 8 servings

## Barbecued Pork Sandwiches

---

**2 lbs. pork blade steaks**  
**1 can (12 oz.) beer**  
**1 small onion, thinly sliced**  
**1 clove garlic, quartered**  
**1 bay leaf**  
**1 cup barbecue sauce**  
**1/4 cup chili sauce**  
**1/4 teaspoon pepper**  
**4 pita bread, 4-inch shredded lettuce**

In 2-quart microwavable casserole, combine pork, beer, onion, garlic and bay leaf. Cover.

Microwave at High Power for 10 minutes, then Cook Power 3 for 40 to 50 minutes, or until pork is tender. Let stand, covered, for 10 minutes. Remove pork and onion. Cool. Discard cooking liquid. Shred pork.

In 2-quart microwavable casserole, mix pork, reserved onion, barbecue sauce, chili sauce and pepper. Cover. Microwave at High Power for 8 to 10 minutes, or until heated through. Discard bay leaf. Serve in pita bread with lettuce.

4 servings

## Bacon-Cheese Burgers

---

**3 slices bacon**  
**1 lb. lean ground beef**  
**2 teaspoons Worcestershire sauce**  
**1/4 teaspoons onion salt**  
**1/8 teaspoon pepper**  
**4 slices (3/4 oz. each) American process cheese**

Place bacon on microwavable roasting rack. Cover with paper towel. Microwave at High Power for 3 to 4 minutes, or until just crisp. Cool. Crumble.

In medium mixing bowl, mix ground beef, bacon, Worcestershire sauce, onion salt and pepper. Shape into 4 patties, 1/2 inch thick. Arrange on microwavable roasting rack. Microwave, uncovered, at High Power for 3 minutes. Turn over. Microwave for 2 to 3 minutes, or until beef is desired doneness. Top each with cheese slice. Microwave at High Power for 45 to 60 seconds, or until cheese melts.

4 servings



## MEATS AND MAIN DISHES

### Wine-Braised Ribs

3 lbs. pork spareribs, cut into 2-rib pieces  
 1 medium onion, sliced  
 2 bay leaves  
 2/3 cup tomato juice  
 1/2 cup white wine  
 1/2 teaspoon dried chervil leaves (optional)  
 1/2 teaspoon dried tarragon leaves

#### Sauce

2 slices bacon, finely chopped  
 1/4 cup finely chopped carrot  
 1/4 cup chopped onion  
 1 clove garlic, minced  
 2 tablespoons all-purpose flour  
 2 teaspoons sugar  
 1/4 teaspoon pepper  
 2 tablespoons tomato paste  
 1 cup beef broth  
 1/3 cup white wine

In large oven cooking bag, combine ribs, onion slices and bay leaves. Place in 8-inch glass baking dish. Set aside.

In small bowl, combine tomato juice, 1/2 cup wine, chervil and tarragon. Pour over ribs. Close bag loosely with string or nylon closure. Microwave at High Power for 10 minutes. Turn bag over. Reduce to Power Level 5. Microwave for 35 to 45 minutes, or until pork is tender. Let stand, covered, for 10 minutes.

#### Sauce:

In 2-quart microwavable casserole, combine bacon, carrot, onion and garlic. Cover. Microwave at High Power for 5 to 6 minutes, or until vegetables are tender, stirring once. Add flour, sugar, pepper and tomato paste. Blend in beef broth and wine. Microwave, uncovered, at High Power for 5 to 6 minutes, or until thickened, stirring twice. Remove ribs from bag. Add to sauce. Microwave at Cook Power 5 for 7 to 8 minutes, or until hot. Let stand 2 minutes. Discard bay leaves.

3 servings

### Greek Beef Kabobs

8 oz. boneless beef sirloin steak,  
 1 inch thick  
 4 small red potatoes, 2-inch  
 1 jar (6 oz.) marinated artichoke  
 hearts (reserve marinade)  
 1/4 teaspoon pepper  
 8 pitted extra large black olives  
 4 wooden skewers, 10-inch

Trim and discard fat from beef. Cut into 1-inch cubes. Set aside.

Trim 1/2-inch strip around center of each potato. Place potatoes in a 1-quart microwavable casserole. Sprinkle with 1 tablespoon artichoke marinade. Cover. Microwave at High Power for 7 to 8 minutes, or until tender. Blend pepper into reserved marinade. Set aside.

Alternate beef, artichoke hearts, olives and potatoes on skewers, placing potatoes in center of skewers. Arrange kabobs on microwavable roasting rack. Brush with marinade. Cover with wax paper. Microwave at High Power for 3 minutes. Rearrange kabobs and turn over. Brush with marinade. Cover. Microwave at High Power for 2 to 3 minutes, or until desired doneness. Brush with marinade.

4 servings

### Southern-Style Pork Chops

1 egg, beaten  
 2 tablespoons French dressing

#### Coating

1/2 cup unseasoned dry bread crumbs  
 1/2 teaspoon paprika  
 1/2 teaspoon onion powder  
 1/2 teaspoon celery salt  
 1/4 teaspoon chili powder  
 1/4 teaspoon pepper  
 4 pork chops, 1/2 inch thick

In shallow bowl, blend egg and dressing. Combine all coating ingredients on a sheet of wax paper. Dip chops in egg mixture, then roll in coating. Press coating onto chops.

Arrange chops on microwavable roasting rack. Microwave at Cook Power 5 for 17 to 18 minutes, or until meat near bone is no longer pink, rearranging chops once. Do not turn chops over. Let stand for 3 minutes.

4 servings

## Sausage and Poppy Seed Potatoes

---

3 tablespoons butter or margarine  
2 tablespoons chopped onion  
3 tablespoons all-purpose flour  
1 tablespoon snipped fresh parsley  
1 teaspoon prepared mustard  
1 teaspoon poppy seed  
1/2 teaspoon salt dash pepper  
1 1/2 cups milk  
3 1/2 cups thinly sliced potatoes (about 1 1/2 lbs.)  
1 lb. fully cooked ring sausage (Polish or smoked country style)

Place butter and onion in 2-quart microwavable casserole. Cover. Microwave at High Power for 2 to 3 minutes, or until tender. Stir in flour, parsley, mustard, poppy seed, salt and pepper. Blend in milk. Microwave, uncovered, at High Power for 5 to 6 minutes, or until thickened, stirring once. Stir in potatoes. Cover. Microwave at High Power for 12 to 13 minutes, or until potatoes are almost tender, stirring once.

Slash sausage 1/2 inch deep at 3-inch intervals. Place sausage on potatoes. Cover. Microwave at High Power for 5 to 6 minutes, or until heated through and potatoes are tender. Let stand for 2 minutes.

4 servings

## Beef Goulash

---

1 lb. boneless beef chuck roast, cut into 3/4-inch cubes  
1/4 cup all-purpose flour  
2 medium potatoes, cut into 8 wedges  
1 can (16 oz.) whole tomatoes, chopped  
1 cup thinly sliced carrots  
2/3 cup water  
1/2 cup chopped onion  
1 tablespoon lemon juice  
1 1/2 teaspoons instant beef bouillon granules  
1 1/2 teaspoons paprika  
1/2 teaspoon garlic salt  
1/2 teaspoon sugar  
1/4 teaspoon dried dill weed  
1/8 teaspoon cayenne

Place beef and flour in large plastic food storage bag. Shake to coat. Pour beef and excess flour into 2-quart casserole. Stir in remaining ingredients. Cover. Microwave at High Power for 10 minutes. Stir. Reduce to Cook Power 5. Microwave for 70 to 75 minutes, or until beef is tender, stirring every 4 minutes. Let stand, covered, for 10 minutes.

4 servings

## Garlic Beef with Carrots

---

### *Marinade*

2 tablespoons vegetable oil  
2 cloves garlic, minced  
1 tablespoon white wine  
1 tablespoon soy sauce  
1 teaspoon sugar  
1/2 teaspoon salt  
1/4 teaspoon sesame oil  
1/8 teaspoon ground ginger  
1 lb. boneless beef sirloin steak, cut into 1/8-inch strips  
1/2 cup thinly sliced green onion  
1/2 cup thinly sliced green pepper  
3 medium carrots, cut into 2 1/2 x 1/8-inch strips (about 2 cups)  
2 teaspoons water  
1 tablespoon vegetable oil  
2 teaspoons cornstarch  
2 teaspoons cold water Hot cooked rice

In medium mixing bowl, combine all marinade ingredients. Add beef, onion and green pepper. Stir to coat. Cover and refrigerate for 30 minutes.

Place carrots in 1-quart microwavable casserole. Cover. Microwave at High Power for 2 1/2 to 3 1/2 minutes, or until tender-crisp. Set aside.

Place oil in 2-quart microwavable casserole. Microwave at High Power for 1 minute. Add meat mixture. Stir to coat. Microwave at High Power for 3 minutes. Add carrots. Set aside.

In 1-cup glass measure, blend cornstarch and water. Add to meat mixture. Stir to combine. Microwave at High Power for 8 to 9 minutes, or until beef is no longer pink and sauce thickens. Serve with rice.

4 servings

## Hoisin Chicken with Walnuts

### Marinade

- 1 tablespoon vegetable oil
- 1 tablespoon soy sauce
- 1 tablespoon dry sherry
- ¼ teaspoon dried crushed red pepper
- ¼ teaspoon garlic powder
- 2 boneless whole chicken breasts, skin removed, cut into 2 × ¾-inch strips
- 6 green onions, cut into 1-inch pieces
- ½ cup walnut halves
- ⅓ cup Hoisin Sauce
- ¼ teaspoon browning sauce
- Hot cooked rice

In small mixing bowl, blend all marinade ingredients. Gently stir in chicken to coat. Cover and refrigerate for 30 minutes. Combine chicken mixture, green onions and walnuts in 1-quart microwavable casserole. Microwave, covered, at High Power for 8 to 9 minutes, or until chicken is no longer pink, stirring twice.

In 1-cup glass measure, blend Hoisin Sauce and browning sauce. Stir into chicken mixture. Let stand 1 minute. Serve over rice.

4 servings

## Cornish Hens with Rice Stuffing

### Stuffing

- ½ cup chopped apple
- 1 tablespoon sliced green onion
- 1 cup cooked white or brown rice
- 2 tablespoons raisins
- 2 tablespoons chopped pecans
- ¼ teaspoon ground cardamom
- ¼ teaspoon ground nutmeg
- ¼ teaspoon salt
- 2 Cornish hens (1½ lbs. each)

In 1-quart casserole, combine apple and onion. Cover. Microwave at High Power for 1 to 2 minutes, or until tender. Stir in remaining stuffing ingredients. Fill cavities of Cornish hens. Place breast-side down on roasting rack.

In 1-cup glass measure, combine all glaze ingredients. Microwave at High Power for 45 to 60 seconds, or until melted. Stir. Set aside.

Cover stuffed hens with wax paper. Microwave at High Power for 10 minutes. Turn hens over. Brush with glaze. Microwave covered at High Power for 10 minutes. Brush with glaze. Microwave, covered, for 5 to 7 minutes longer, or until legs move freely and juices run clear, brushing with glaze once. Let stand 2 minutes.

### Glaze

- ¼ cup apple jelly
- 1 teaspoon butter or margarine
- ½ teaspoon browning sauce

2 servings

## Chicken Enchiladas

### Filling

- 1 cup chopped green pepper
- ½ cup chopped zucchini
- 1 clove garlic, minced
- 2 cups cut-up cooked chicken
- 1 can (15 oz.) tomato sauce (reserve ½ cup)
- ½ cup refried beans
- ½ teaspoon salt
- ½ teaspoon dried oregano leaves
- ¼ teaspoon ground cumin
- ¼ teaspoon sugar
- 4 flour tortillas, 8-inch diameter
- 1 cup shredded Cheddar cheese

In 1½-quart casserole, combine green pepper, zucchini and garlic. Cover. Microwave at High Power for 5 to 6 minutes, or until tender. Stir in remaining filling ingredients. Cover. Microwave at High Power for 8 to 9 minutes, or until heated through and flavors are blended, stirring once. Set aside.

Soften tortillas by placing between damp paper towels. Microwave at High Power for 45 to 60 seconds, or until warm. Spoon ¼ of the filling in center of each tortilla. Roll up tortillas. Place in 8-inch square baking dish. Top with reserved tomato sauce. Sprinkle with cheese. Microwave at Cook Power 5 for 8 to 9 minutes, or until cheese melts.

4 servings

## Salmon and Fettuccine

---

**4 salmon steaks**  
(about 1½ lbs.) cooked  
**¼ cup butter or margarine**  
**1 medium zucchini**, cut into  
2-inch x ¼-inch strips (about 1 cup)  
**1 cup sliced fresh mushrooms**  
**2 tablespoons all-purpose flour**  
**½ teaspoon dried dill weed**  
**½ teaspoon salt**  
**⅛ teaspoon pepper**  
**1½ cups half-and-half or milk**  
**8 oz. fettuccine**, cooked and hot  
**¼ cup grated Parmesan cheese**

Remove and discard skin and bones from cooked salmon. Flake with fork. Set aside. In 2-quart casserole, combine butter, zucchini and mushrooms. Cover. Microwave at High Power for 4 to 5 minutes, or until zucchini is tender-crisp, stirring once. Stir in flour, dill weed, salt and pepper. Blend in half-and-half. Microwave at High Power for 7 to 8 minutes or until mixture thickens, stirring twice. Stir in salmon. Toss with fettuccini. Sprinkle with cheese.

4 servings

## Cauliflower Clam Chowder

---

**1 cup cauliflowerets**, ½-inch pieces  
**¼ cup chopped celery**  
**¼ cup shredded carrot**  
**2 tablespoons sliced green onion**  
**2 tablespoons butter or margarine**  
**3 tablespoons all-purpose flour**  
**2 teaspoons snipped fresh parsley**  
**1 teaspoon instant chicken bouillon granules**  
**½ teaspoon salt**  
**⅛ teaspoon dried summer savory**  
**⅛ teaspoon white pepper**  
**1½ cups milk**  
**½ cup water**  
**1 can (6½ oz.) minced clams**, drained

In 1½-quart microwavable casserole, combine cauliflowerets, celery, carrot, onion and butter. Cover. Microwave at High Power for 5 to 6 minutes, or until vegetables are tender, stirring once. Stir in flour, parsley, bouillon, salt, summer savory and pepper. Blend in milk and water. Stir in clams. Microwave, uncovered, at High Power for 9 to 10 minutes, or until mixture thickens, stirring twice.

4 servings

## Sole Knots

---

**1 lb. fresh sole fillets**, ¼ inch thick,  
cut into 10-inch x 2-inch strips  
**3 tablespoons butter or margarine**  
**2 tablespoons all-purpose flour**  
**½ teaspoon salt**  
**½ teaspoon dried tarragon leaves**  
**1 teaspoon grated orange peel**,  
divided  
**1 cup half-and-half**  
**2 tablespoons snipped fresh parsley**

Tie each sole strip into a knot. Set aside.

Place butter in 8-inch round baking dish. Microwave at High Power for 1 to 1½ minutes, or until butter melts. Stir in flour, salt, pepper, tarragon and ½ teaspoon orange peel. Blend in half-and-half. Microwave uncovered at High Power for 3 to 4 minutes, or until mixture thickens, stirring twice.

Arrange fish knots on sauce. Sprinkle with parsley and remaining orange peel. Cover with wax paper. Microwave at Cook Power 7 for 10 to 12 minutes, or until fish flakes easily with fork.

4 servings

## Oyster Stew

---

**¼ cup butter or margarine**  
**2 tablespoons all-purpose flour**  
**¼ teaspoon white pepper**  
**1 can (12 oz.) evaporated milk**  
**1 cup chicken broth**  
**1 pint fresh oysters**  
**2 tablespoons oyster liquor Paprika**

Place butter in 2-quart microwavable casserole. Microwave at High Power for 1 to 1½ minutes, or until butter melts. Stir in flour and pepper. Blend in milk and chicken broth. Stir in oysters and oyster liquor. Microwave at High Power for 9 to 10 minutes, or until oysters are firm and edges curl, stirring twice. Sprinkle each serving with paprika.

4 servings

# EGGS AND CHEESE

## Scrambled Eggs

Microwavable Dish	Butter	Eggs	Milk	Salt	Pepper	Cooking Time
15 oz. bowl	1 table-spoon	2	1 table-spoon	Dash	Dash	1½ to 2 minutes
1-quart casserole	2 table-spoons	4	2 table-spoons	¼ tea-spoon	⅛ tea-spoon	2½ to 3½ minutes
1-quart casserole	¼-cup	8	¼ cup	½ tea-spoon	⅛ tea-spoon	4½ to 5½ minutes

Place butter in microwavable dish or casserole. Microwave at High Power for 30 to 90 seconds, or until butter melts. Blend in eggs, milk, salt and pepper.

Microwave at High Power as directed above, or until eggs are set but still moist, stirring twice. Cover with waxed paper. Let stand 1 to 3 minutes. Eggs will become firm as they stand.

1 to 4 servings

## California Omelet

- ½ cup quartered cherry tomatoes
- 2 tablespoons sliced green onion
- 2 tablespoons sliced black olives
- 2 tablespoons butter or margarine, divided
- 1 medium avocado, peeled and cut into 1-inch cubes
- ⅛ teaspoon garlic powder
- 3 eggs, separated
- 1 tablespoon milk
- ¼ teaspoon salt
- ⅛ teaspoon pepper
- ½ cup shredded Monterey Jack cheese

In 1-quart microwavable casserole, combine tomatoes, onion, olives and 1 tablespoon butter. Cover. Microwave at High Power for 1 to 1½ minutes, or until butter melts. Stir in avocado and garlic powder. Set aside.

Place 1 tablespoon butter in 9-inch glass pie plate. Microwave at High Power for 30 to 45 seconds, or until butter melts. Tilt to coat bottom. Set aside.

In small mixing bowl, beat egg whites at high speed of electric mixer until stiff but not dry. In small bowl, blend egg yolks, milk, salt and pepper. Fold egg yolk mixture into egg whites. Pour into pie plate.

Microwave, uncovered, at Cook Power 5 for 7 to 8 minutes, or until set, lifting edge of omelet twice with spatula so uncooked portions spread. Sprinkle filling mixture and half the cheese on half of omelet. Loosen omelet with spatula. Gently fold over filling. Sprinkle with remaining cheese. Microwave uncovered at Cook Power 5 for 1 to 1½ minutes, or until cheese melts.

2 servings

## Cheese Sauce

- 2 tablespoons butter or margarine
- 2 tablespoons all-purpose flour
- ¼ teaspoon salt
- ¼ teaspoon dry mustard Dash pepper
- 1¼ cups milk
- ¾ cup shredded pasteurized process American cheese

Place butter in 4-cup glass measure. Microwave at High Power for 45 to 60 seconds, or until butter melts. Stir in flour, salt, mustard and pepper. Blend in milk. Microwave at High Power for 5 to 6 minutes, or until mixture thickens and bubbles, stirring twice. Stir in cheese until cheese melts and sauce is smooth.

1½ cups

# VEGETABLES AND FRUITS

---

## Twice-Baked Potatoes

---

4 medium (6 to 8 oz. each) baking potatoes, microwaved  
2 slices bacon  
½ cup shredded Cheddar cheese  
½ cup dairy sour cream  
1 egg, beaten  
2 tablespoons butter or margarine  
2 tablespoons snipped fresh parsley  
½ teaspoon salt  
⅛ teaspoon pepper

Place bacon on microwavable roasting rack; cover with paper towel. Microwave at High Power for 2 to 2½ minutes, or until just crisp. Cool. Crumble. Set aside.

Cut a ¼-inch thick strip about 2½ inches wide from top of each potato. Scoop out centers to within ¼ inch of edge. Reserve potato shells. In large mixing bowl, combine potato pulp and remaining ingredients. Beat at medium speed of electric mixer until blended. Spoon a fourth of the potato mixture into each potato shell.

Arrange potatoes on 10-inch microwavable plate. Microwave, uncovered, at High Power for 7 to 8 minutes, or until hot. Let stand 2 minutes.

4 servings

## Glazed Carrots

---

1 lb. carrots, cut into ¼-inch slices  
½ teaspoon grated orange peel  
2 tablespoons water  
2 tablespoons packed brown sugar  
2 tablespoons honey  
1 tablespoon butter or margarine  
⅛ teaspoon pepper  
¼ teaspoon ground ginger

In 1½-quart microwavable casserole, combine carrots, orange peel and water. Cover. Microwave at High Power for 7 to 8 minutes, or until tender, stirring once. Drain. Cover. Set aside.

In 4-cup glass measure, mix remaining ingredients. Microwave, uncovered, at High Power for 1½ to 2 minutes, or until thickened. Pour over carrots. Toss to coat.

4 servings

## Orange Baked Apples

---

⅓ cup butter or margarine  
2 tablespoons sugar  
2 tablespoons chopped pecans  
1 teaspoon grated orange peel  
⅛ teaspoon ground nutmeg  
4 large baking apples, about 10 oz. each  
2 tablespoons brandy or apple juice  
Sweetened whipped cream

Place butter in 1-cup glass measure. Microwave at Cook Power 5 for 15 to 20 seconds, or until softened. Stir in sugar, pecans, orange peel and nutmeg.

Remove thin strip of peel from top of each apple. Remove and discard core. Set aside.

Spoon a fourth of the butter mixture into each apple. Place apples in 8-inch square baking dish. Sprinkle with brandy. Cover with vented plastic wrap. Microwave at High Power for 14 to 16 minutes, or until tender. Let stand, covered, for 5 minutes. Serve with whipped cream.

4 servings

## Baked Grapefruit

---

2 large grapefruit, about 1½ lbs. each  
1 cup cornflakes, coarsely crushed  
¼ cup chopped walnuts  
2 tablespoons raisins  
2 tablespoons sugar  
1 tablespoon dark corn syrup  
¼ teaspoon ground cinnamon  
4 maraschino cherries

Cut grapefruit in half crosswise. Loosen each section with knife. Place on 8-inch microwavable round plate. Set aside.

In small mixing bowl, combine remaining ingredients, except cherries. Spread a fourth of the cornflake mixture on each grapefruit half. Place cherry in center of each half. Microwave at High Power for 7 to 9 minutes, or until heated through. Let stand 2 minutes.

4 servings

## DESSERTS

### Cheese Pie with Fresh Fruit

9-inch graham cracker crust

#### Filling

2 pkgs. (3 oz. each) cream cheese

2 eggs

$\frac{2}{3}$  cup ricotta cheese

3 tablespoons sugar

1 tablespoon fresh lemon juice

#### Topping

$\frac{1}{4}$  cup dairy sour cream

1 tablespoon sugar

1 cup sliced fresh strawberries,  
peaches or grapes

Place cream cheese in medium sized microwavable mixing bowl. Microwave at Cook Power 5 for 1 to  $1\frac{1}{2}$  minutes, or until softened. Add remaining filling ingredients. Beat at medium speed of electric mixer until filling is smooth. Pour into prepared crust. Microwave at Cook Power 5 for 14 to 16 minutes, or until edges of filling are firm and center is soft-set. Let stand on counter for 10 minutes.

In small bowl, blend sour cream and sugar. Spread on top of pie. Refrigerate for 4 hours. Top with fresh fruit before serving.

One 9-inch pie

### Caramel Crisp Bars

1 bag (14 oz.) light caramels

2 tablespoons milk

6 cups corn flakes

1 cup salted peanuts

1 cup chocolate chips

1 tablespoon vegetable shortening

Butter 8-inch glass baking dish. Set aside.

In large mixing bowl, combine cornflakes and peanuts. Set aside. In 2-quart microwavable casserole, combine caramels and milk. Microwave at High Power for 3 to 4 minutes, or until mixture can be stirred smooth, stirring every 1 minute. Stir in corn flakes and peanuts. Press mixture into prepared baking dish. Set aside.

In 2-cup glass measure, combine chocolate chips and shortening. Microwave at High Power for 1 to  $1\frac{1}{2}$  minutes, or until mixture is smooth, stirring once. Drizzle chocolate over bars. Cool until set. Cut into bars.

16 bars

### Butterscotch Topping

$\frac{1}{3}$  cup packed brown sugar

$\frac{1}{4}$  cup granulated sugar

4 teaspoons all-purpose flour

$\frac{1}{4}$  cup half-and-half

$\frac{1}{4}$  cup butter or margarine

1 tablespoon light corn syrup

$\frac{1}{4}$  teaspoon vanilla

Dash salt

Ice cream or cake

In 2-cup glass measure, combine brown sugar, granulated sugar and flour. Blend in remaining ingredients. Microwave at High Power for 3 to 4 minutes, or until mixture boils. Mix well. Microwave at Cook Power 7 for 5 to 6 minutes, or until mixture thickens, stirring twice. Serve warm over ice cream or cake.

$\frac{2}{3}$  cup

### Pudding Mix

1 pkg. (3 to  $3\frac{1}{2}$  oz.) pudding and pie filling mix, NOT INSTANT

2 cups milk

Place pudding mix in 1-quart glass measure. Blend in milk with whisk. Microwave at High Power for 7 to 8 minutes, or until pudding boils, stirring twice. Let stand 2 minutes. Cool according to package directions.

4 servings

# MEAT DEFROSTING CHART

Cut and Weight	Defrosting Time at Quick Defrost	Standing Time	Directions
<b>MEAT</b>			
<b>BEEF</b>			
Ground beef 1 lb. 2 lbs.	11 to 12 minutes 10 to 11 minutes per lb.	10 minutes 10-15 minutes	Turn over once.* Remove thawed portions with fork Return remainder to oven to defrost. (The best way to freeze ground beef is in a doughnut shape.)
Pot roast, chuck under 4 lbs.	11 to 13 minutes per lb.	15-20 minutes	Turn over once.*
Rib roast, rolled 3 to 4 lbs.	15 to 17 minutes per lb.	30 minutes	Turn over once.*
Rump roast 3 to 4 lbs.	15 to 17 minutes per lb.	30 minutes	Turn over once.*
Round steak	7 to 10 minutes	10-15 minutes	Turn over once.*
Sirloin steak ½ inch thick	10 to 12 minutes per lb.	10-15 minutes	Turn over once.*
Tenderloin steak	12 to 14 minutes per lb.	15 minutes	Turn over once.*
Stew beef 2 lbs.	6 to 8 minutes per lb.	10-15 minutes	Turn over once.* Separate.
<b>LAMB</b>			
Cubed for stew	9 to 12 minutes per lb.	10 minutes	Separate and rearrange as necessary.
Ground lamb under 4 lbs.	11 to 12 minutes per lb.	10-15 minutes	Turn over once.*
Chops 1 inch thick	11 to 12 minutes per lb.	15 minutes	Turn over once.*
<b>PORK</b>			
Chops ½ inch thick	11 to 12 minutes	10 minutes	Defrost 2 at a time, single layer. Rearrange chops halfway through defrosting time.
Spareribs. Country-style ribs 2 to 3 lbs.	13 to 15 minutes per lb.	10 minutes	Turn over once.*
Roast under 4 lbs.	14 to 16 minutes per lb.	30 minutes	Turn over once.*
Bacon under 4 lbs.	7 to 8 minutes	5 minutes	Defrost until strips separate. Recommend defrosting 1 pound at a time.
Sausage, bulk 1 lb.	6 to 7 minutes	5 minutes	Turn over once.* Remove thawed portions with fork. Return remainder to oven to defrost.
Sausage, links 1 lb.	6 to 7 minutes	5 minutes	Turn over once.* Defrost until pieces can be separated.
Hot dogs 1 lb.	9 to 10 minutes per lb.	5 minutes	

\* Turning or stirring should be done after ¼th of the defrosting cycle.



# POULTRY/FISH AND SEAFOOD DEFROSTING CHART

Cut and Weight	Defrosting Time at Quick Defrost	Standing Time	Directions
<b>POULTRY</b>			
<b>CHICKEN</b> Whole 2 to 3 lbs.	11 to 13 minutes per lb.	45 minutes	Turn over once.* Immerse in cold water for standing time.
Cut up 2 to 3 lbs.	12 to 14 minutes per lb.	15 minutes	Turn over once.* Separate pieces when partially thawed.
<b>TURKEY</b> Breast under 4 lbs.	11 to 13 minutes per lb.	20 minutes	Turn over once.*
<b>CORNISH HENS</b> Whole 1 to 1½ lbs.	12 to 13 minutes per lb.	25 minutes	Turn over once.* Immerse in cold water for standing time.
<b>FISH AND SEAFOOD</b>			
<b>FISH</b> Fish fillets 1 lb.	12 to 13 minutes		Defrost in package on dish. Turn over once.* After defrosting, carefully separate fillets under cold water.
Fish steaks 1 lb.	12 to 13 minutes		Defrost in package on dish. After defrosting, carefully separate steaks under cold running water.
Whole fish 8 to 10 oz.	7 to 9 minutes	10 minutes	Use a shallow dish; the shape of the fish determines size. Cover the head with aluminum foil. Be careful not to let foil touch sides or door of oven. Turn over once.* The fish should be icy when removed from oven. Finish thawing while standing at room temperature.
Lobster tails 8 oz. pkg.	8 to 9 minutes		Remove from package to baking dish. Rinse under cold running water.
Crab legs 8 to 10 oz.	6 to 8 minutes		Use a glass baking dish. Break the legs apart and turn over once. Rinse under cold running water.
Crabmeat 6 oz.	7 to 9 minutes	10 minutes	Defrost in package on dish. Break apart and turn over once. After defrosting immerse in cold water.
Shrimp 1 lb.	9 to 10 minutes	5-10 minutes	Remove from package to dish. Spread loosely in baking dish and rearrange during thawing as necessary. Rinse under cold running water.
Scallops 1 lb.	13 to 14 minutes	10 minutes	Defrost in package, if in block; spread out on baking dish if in pieces. Turn over and rearrange during thawing as necessary.

\* Turning or stirring should be done after ¼ of the defrosting cycle.

# MICROWAVING TIME TABLE

## MEAT COOKING TABLE

Meat	Cook Power	Cooking Time	Special Instructions
<b>BEEF</b> Corned beef (2-3 lbs.)	High  5	15 minutes then 30-35 minutes per pound	Place corned beef in 2-quart microwavable casserole. Pour 1 cup water and desired seasonings over corned beef. Cook covered. Turn over beef during cooking. Shield thinner ends with foil. Cook until fork-tender. Let stand covered 15 minutes. Thinly slice beef diagonally across grain.
Cubes for stew (1 lbs., 1-inch cubes)	High  5	10 minutes  25-30 minutes per pound	Place cubes in 2-quart microwavable casserole. Pour 1 cup water or broth over cubes. Cook covered. Stir cubes halfway through cooking. Cook until fork-tender. Let stand covered 10 minutes.
Ground beef (1 lb.)	High	5½-6½ minutes	Crumble beef and place in microwavable sieve or colander. Place sieve in bowl to collect drippings. Cover with waxed paper. Stir after 3 minutes to break meat apart. After cooking let stand covered 2 minutes. If meat is still pink, cover and cook 1 more minute.
Hamburgers, Fresh or defrosted frozen (4 oz, each) 1 patty 2 patties 4 patties	High	1-1½ minutes 3-4 minutes 4½-5 minutes	Form patties with depression in center of each. Place on microwavable roast rack. Brush with browning agent, if desired. Cover with waxed paper. Turn over halfway through cooking. Let stand covered 1 minute.
Pot roast (3-4 lbs.)	High  5	10 minutes then 25-30 minutes per pound	Pierce roast deeply on both sides in several places. Place roast in large cooking bag; place in microwavable dish. Add desired seasonings and 1 cup liquid over roast. Close bag loosely with microwavable closure or string. Carefully turn over meat after 35 minutes. Continue cooking until fork-tender. Let stand covered 10 minutes.

## MEAT COOKING TABLE (Cont'd)

Meat	Cook Power	Cooking Time	Special Instructions
Rib roast, rolled (3-4 lbs.)	5	10-12 minutes per pound RARE (135°F) 12-14 minutes per pound MEDIUM (155°F) 13-15 minutes per pound WELL (165°F)	Place roast fat side down on microwavable roast rack. Add desired seasonings and cover with waxed paper. Turn over meat half way through cooking and shield if necessary. Remove roast from microwave when desired temperature is reached. Let stand covered with foil 15 minutes. (Temperature may rise about 10°F).
Rump roast, rolled (3-4 lbs.)	5	12-14 minutes per pound RARE (135°F) 15-17 minutes per pound MEDIUM (155°F)	Place roast fat side down on microwavable roast rack. Add desired seasonings and cover with waxed paper. Turn over meat halfway through cooking and shield if necessary. Let stand covered with foil 15 minutes. Remove roast from microwave when desired temperature is reached. (Temperature may rise about 10°F).
Sirloin tip roast (3-4 lbs.)	High	10-12 minutes per pound RARE (135°F) 12-14 minutes per pound MEDIUM (155°F)	Place roast fat side down on microwavable roast rack. Add desired seasonings and cover with waxed paper. Turn over meat halfway through cooking and shield if necessary. Remove roast from microwave when desired temperature is reached. Let stand covered with foil 15 minutes. (Temperature may rise about 10°F).
<b>LAMB</b> Lamb roast, rolled, boneless (3-4 lbs.)	High	9-10 minutes per pound RARE (135°F) 11-12 minutes per pound MEDIUM (145°F) 12-13 minutes per pound WELL (155°F)	Place roast fat side up on microwavable roast rack. Brush lamb with marinade or desired seasonings such as rosemary, thyme or marjoram. Cover with waxed paper. Shield if necessary. Remove roast from microwave when desired temperature is reached. Let stand covered with foil 15 minutes. (Temperature may rise about 10°F).

## MEAT COOKING TABLE (Cont'd)

Meat	Cook Power	Cooking Time	Special Instructions
Lamb stew cubes (1 lbs.) 1-inch	High  5	10 minutes then 25-30 minutes per pound	Place cubes in 2-quart microwavable casserole. Add desired seasonings such as rosemary, thyme and marjoram and 1 cup water. Cook covered. Stir cubes twice during cooking. Cook until fork-tender. Let stand covered 15 minutes.
<b>PORK</b> Bacon slices 2 slices 4 slices	High	2-2½ minutes 4-4½ minutes	Place bacon slices on microwavable roast rack. Cover with paper towels. After cooking let stand 1 minute.
Canadian bacon 2 slices 4 slices	High	45-60 seconds 1½-2 minutes	Place meat on microwavable roast rack. Cover loosely with waxed paper. After cooking let stand 1 minute.
Chops (5-7 oz. each) 2 chops 4 chops	5	17-18 minutes per pound 14-15 minutes per pound	Place chops in microwavable baking dish. Add desired seasonings and cover with plastic wrap and vent. Cook until no longer pink or until internal temperature reaches 170°F. Turn over chops. Let stand covered 5 minutes. (Temperature may rise about 10°F).
Hot dogs 1 2 4	High	30-45 seconds 45-60 seconds 1½-2 minutes	Pierce hot dogs and place on microwavable roast rack. Cover with waxed paper. If in bun, wrap in paper towel or paper napkin to absorb moisture. After cooking, let stand 1 minute.
Ham, boneless fully cooked 3 lbs.	5	15-18 minutes per pound	Place ham on microwavable roast rack. Cover with waxed paper. Turn over ham halfway through cooking. Cook until internal temperature reaches 120°F. Let stand covered 10 minutes.
Ham, center slice (1 lb., ½-inch)	High	3-4 minutes	Place slices on microwavable roast rack. Cover with plastic wrap and vent. Let stand covered 1 minute.
Loin-Roast, rolled, boneless (3½-4½ lbs.)	3	20-25 minutes per pound	Place roast in cooking bag in microwavable dish. Add seasonings and browning agent if desired. Glose bag loosely with microwavable closure or string. Turn over roast halfway through cooking. After cooking let stand in bag 15 minutes. (Temperature may rise about 10°F.) Internal temperature of pork should reach 170°F before serving.

### MEAT COOKING TABLE (Cont'd)

Meat	Cook Power	Cooking Time	Special Instructions
Sausage links, Fresh or defrosted frozen (1-2 oz. each) 2 links 4 links 6 links	High	1-1½ minutes 2-2½ minutes 3-3½ minutes	Pierce links and place on microwavable roast rack. Cover with waxed paper or paper towel. After cooking, let stand covered 1 minute.
Sausage patties, Fresh (2 oz. each) 2 patties 4 patties 8 patties	High	2-2½ minutes 3½-4 minutes 4½-5 minutes	Place sausage patties in a circle on microwavable roast rack. Brush with browning agent if desired. Cover with waxed paper. Turn patties over halfway through cooking. After cooking, let stand 2 minutes.
Spareribs (2½-3½ lbs.)	High  then 5   then High if desired	10 minutes  12-16 minutes per pound   10 minutes if desired	Place ribs, cut into serving size pieces, bone side down in large cooking bag. Place bag in 2-quart microwavable casserole. Add 1 cup water to bag. Close bag loosely with microwavable closure or string. Turn over ribs, rearranging carefully, halfway through cooking. Cook until meat is fork-tender. Carefully remove ribs.  If desired, brush sauce over ribs. Cook covered with waxed paper. Let stand covered 10 minutes. (Temperature may rise about 10°F).*  * Internal temperature of pork should reach 170°F before serving.

## POULTRY COOKING TABLE

Poultry	Cook Power	Cooking Time	Special Instructions
<b>CHICKEN</b> Breasts, boneless 1 half breast (4-5 oz.)  1 whole breast (10-12 oz.)  2 whole breasts (20-24 oz.)	High	10-11 minutes per pound  7-8 minutes per pound  7-8 minutes per pound	Wash and dry poultry. Remove skin and place breasts, thickest portion to outside, in 8-inch microwavable baking dish. Brush with butter or browning agent and seasonings if desired. Cover with waxed paper. Cook until no longer pink and juices run clear. Let stand covered 3 minutes.
Cut up fryer (2½-3 lbs.)	High	7-8 minutes per pound	Wash and dry poultry. Place pieces in single layer in 8-inch microwavable baking dish with thicker pieces to the outside. Brush with butter or browning agent and seasonings if desired. Cover with waxed paper. Cook until no longer pink and juices run clear. Let stand covered 5 minutes.
Whole (2½-3 lbs.)	High	8-10 minutes per pound	Wash and dry poultry. Place breast side down on microwavable roast rack. Brush with butter, or browning agent and seasonings if desired. Cover with waxed paper. Cook ⅓ of estimated time. Turn breast side up, brush on butter, or browning agent. Replace waxed paper. Cook ⅓ of estimated time again. Shield if necessary. Cook remaining ⅓ of estimated time or until no longer pink and juices run clear. Let stand covered with foil 10 minutes. (Temperature may rise about 10°F). Temperature in thigh should be 180°F-185°F when done.
<b>TURKEY</b> Breast, boneless (2-3 lbs.)	High	20-21 minutes per pound	Place thawed turkey breast, on microwavable roast rack. Cover with waxed paper. Cook ⅓ of estimated time. Turn breast over. Replace waxed paper. Cook ⅓ of estimated time again. Turn breast over. Shield if necessary. Cook remaining ⅓ of estimated time or until no longer pink and juices run clear. Remove from microwave when desired temperature is reached. Let stand covered with foil 10 minutes. (Temperature may rise about 10°F). Temperature in breast should be 170°F before serving.

### POULTRY COOKING TABLE (Cont'd)

Poultry	Cook Power	Cooking Time	Special Instructions
Drumsticks (1½-2 lbs.)	High	12-13 minutes per pound	Wash and dry poultry. Place pieces with thickest portion to outside on microwavable roast rack. Brush with butter or browning agent and seasonings if desired. Cover with waxed paper. Turn over pieces, shield bone ends with small pieces of foil and replace waxed paper halfway through cooking. Cook until no longer pink and juices run clear. Let stand covered 5 minutes.
<b>CORNISH HENS</b> Whole (1-1½ lbs. each)	High	8½-9½ minutes per pound	Wash and dry poultry. Tie wings to body of hen and the legs to tail. Place hens breast side down on microwavable roast rack. Cover with waxed paper. Turn breast side up. Shield bone ends of drumsticks with foil. Remove and discard drippings. Brush with butter or browning agent and seasonings if desired. Cook until no longer pink and juices run clear. Remove hens from microwave when desired temperature is reached. Let stand covered with foil 5 minutes. (Temperature may rise about 10°F). Temperature in breast should be 170°F before serving.

### FISH AND SHELLFISH COOKING TABLE

Fish/Shellfish	Cook Power	Cooking Time Minutes Per Pound	Special Instructions
Fish fillets	High	5½ to 6½ minutes	Arrange in single layer with thickest portion toward outside edge of 8-inch glass baking dish. Brush fish with melted butter and season, if desired. Cook covered with vented plastic wrap. Let stand covered 2 minutes.
Fish steaks	High	6½ to 7½ minutes	
Whole fish	High	6 to 7 minutes	
Scallops	High	4 to 5 minutes	Cook as directed above except stir in place of rotating dish.
Shrimp, shelled	High	4 to 5 minutes	
Lobster tail	High	4 to 5 minutes	Cut hard shell down middle with knife. Grasp tail with both hands and open flat. Place flesh side up in 8-inch glass baking dish. Cook covered with waxed paper. Let stand covered 2 minutes.

## VEGETABLE COOKING TABLE

Vegetables	Cooking Time	Special Instructions
Artichokes Fresh (8 oz. each) 2 medium 4 medium	High 8-9 minutes 13-14 minutes	Place trimmed artichokes, right side up, in 8-inch microwavable baking dish. Add 2 teaspoons lemon juice and 2 tablespoons water. Cover with plastic wrap and vent. Cook until lower leaves can be pulled off and base pierces easily with fork. Let stand covered 2 minutes.
Asparagus, Fresh, spears (1 lb.)	High 8-9 minutes	Place spears in single layer in 2-quart microwavable baking dish, alternating tips and thick ends, with thickest stalks to outside of dish. Add 2 tablespoons water. Cover with plastic wrap and vent. Cook until tender-crisp. Let stand covered 2 minutes.
Frozen, spears (10 oz. pkg.)	High 7-8 minutes	Remove outer wrapping from box. Place box on 2 paper towels. After cooking, let stand 2 minutes.
Beans, green & wax Fresh, cut (1 lb.)	High 10-12 minutes	Place beans and 2 tablespoons water in 1½-quart microwavable covered casserole. Stir halfway through cooking. Cook until tender-crisp. Let stand covered 2 minutes.
Beets, Fresh (1 lb.)	High 18-19 minutes	Place beets and ¼ cup water in 1½-quart microwavable covered casserole. Rearrange halfway through cooking. Cook until beets pierce easily with fork. Let stand covered 2 minutes. Peel after cooking.
Broccoli, Fresh, spears (1 lb.)	High 10-11 minutes	Place broccoli in single layer in 2-quart baking dish with flowerets toward center of dish. Add 2 tablespoons water. Cover with plastic wrap and vent. Cook until tender-crisp. Let stand covered 2 minutes.
Brussels sprouts Fresh, (1 lb.) 3-4 cups	High 10-11 minutes	Place Brussels sprouts and 2 tablespoons water in 2-quart microwavable covered casserole. Stir halfway through cooking. Cook until tender-crisp. Let stand covered 2 minutes.
Cabbage, Fresh, chopped (1 lb.) 1 medium	High 9-10 minutes	Place cabbage and ¼ cup water in 2-quart microwavable covered casserole. Stir halfway through cooking. Cook until tender-crisp. Let stand covered 2 minutes.
Carrots, Fresh, sliced 1 lb.	High 7-8 minutes	Place carrots and 2 tablespoons water in 1-quart microwavable covered casserole. Stir halfway through cooking. Cook until tender-crisp. Let stand covered 2 minutes.



## VEGETABLE COOKING TABLE (Cont'd)

Vegetables	Cooking Time	Special Instructions
Cauliflower Fresh, whole (1 lb.) Fresh, flowerets 2 cups	High 7-8 minutes High 4-5 minutes	Place trimmed cauliflower and 2 tablespoons water in 1 or 1½-quart microwavable covered casserole. Cook until tender-crisp. Let stand covered 2 minutes.
Celery, Fresh, sliced 4 cups, 1-inch pieces	High 8-9 minutes	Place sliced celery and 2 tablespoons water in 1½-quart microwavable covered casserole. Stir halfway through cooking. Cook until tender-crisp. Let stand covered 2 minutes.
Corn, Fresh, on cob 2 ears 4 ears	High 10-11 minutes 17-18 minutes	Place husked corn and 2 tablespoons water in 8-inch microwavable baking dish. Cover with plastic wrap and vent. Cook until tender-crisp. Let stand covered 5 minutes.
Eggplant, Fresh, whole (1 lb.)	High 4-5 minutes	Pierce eggplant with fork and place on 2 paper towels. Turn over halfway through cooking. Cook until fork pierces skin easily. Let stand 2 minutes. Cut in half to remove pulp.
Leeks, Fresh, sliced (8 oz.) 3 cups	High 6-7 minutes	Place sliced leeks and 2 tablespoons water in 1-quart microwavable covered casserole. Stir halfway through cooking. Cook until fork tender. Let stand covered 2 minutes.
Mixed Vegetables Frozen (10 oz.)	High 7-8 minutes	Remove outer wrapping from box. Place box on 2 paper towels. After cooking, let stand 2 minutes.
Mushrooms Fresh, sliced (½ lb.) (1 lb.)	High 4-4½ minutes 5½-6 minutes	Place sliced mushrooms in 1 to 1½-quart microwavable covered casserole. Stir halfway through cooking. As soon as mushrooms begin to darken, remove and let stand covered 2 minutes.
Onions, Fresh, whole pearl (10 oz. pkg.) Fresh, chopped (8 oz.)	High 6-7 minutes High 8-9 minutes	Place peeled onions and 2 tablespoons water in 1-quart covered microwavable casserole. Stir halfway through cooking. Cook until onions are translucent. Let stand 2 minutes.
Parsnips, Fresh sliced (1 lb.)	High 8-9 minutes	Place parsnips and 2 tablespoons water in 1½-quart microwavable covered casserole. Stir halfway through cooking. Cook until fork tender. Let stand covered 2 minutes.
Peas and Carrots Frozen (10 oz.)	High 6-7 minutes	Remove outer wrapping from box. Place box on 2 paper towels. After cooking, let stand 2 minutes.
Peas, green Fresh (1 lb.) 4 cups	High 7-8 minutes	Place shelled peas and 2 tablespoons water in 1½-quart microwavable covered casserole. Stir halfway through cooking. Let stand covered 2 minutes.

## VEGETABLE COOKING TABLE (Cont'd)

Vegetables	Cooking Time	Special Instructions
Potatoes, sweet Whole (6-8 oz. each) 1 medium potato 2 medium potatoes 4 medium potatoes	High 3-4 minutes 6-7 minutes 8-9 minutes	Pierce potatoes several times with fork. Place in circle on 2 paper towels. Turn over potatoes and rearrange halfway through cooking. Remove potatoes when soft to the touch. Wrap in foil and let stand 5 minutes.
Potatoes, white Whole baking (6-8 oz. each) 1 potato 2 potatoes 4 potatoes	High 5-6 minutes 8-9 minutes 14-15 minutes	Pierce potatoes several times with fork. Place in circle on 2 paper towels. Turn over potatoes and rearrange halfway through cooking. Remove potatoes when soft to touch. Wrap in foil and let stand 5 minutes.
Spinach, Fresh, leaf (1 lb.)  Frozen, chopped (9 oz. pouch) (10 oz.)	High 9-10 minutes  High 6½-7½ minutes 8½-9½ minutes	Place spinach and 2 tablespoons water in 3-quart microwavable covered casserole. After cooking, let stand covered 2 minutes.  Remove outer wrapping from box or pouch. Place box on 2 paper towels. Pierce pouch with fork and place in 1½-quart microwavable casserole. After cooking, let stand 2 minutes.
Squash, Acorn or Butternut Fresh (1-1½ lbs.) 1 medium  Frozen, cooked (12 oz.)	High 11-12 minutes  High 9-10 minutes	Pierce squash several times with fork. Place on 2 paper towels. Carefully remove halfway through cooking. Cut squash in half, remove fibrous strands and seeds. Place in 8-inch microwavable baking dish. Cover with plastic wrap and vent. After cooking, let stand covered 2 minutes.  Remove outer wrapping from box. Place box on 2 paper towels. After cooking, let stand 2 minutes.
Squash, Spaghetti Fresh, (2-3 lbs.) 1 medium whole	High 13-15 minutes	Pierce squash several times with fork. Place squash on 2 paper towels. Turn over several times during cooking. Let stand 2 minutes. Cut in half. Remove fibrous strands and seeds from center.
Succotash Frozen, (10 oz.)	High 7-8 minutes	Remove outer wrapping from box. Place box on 2 paper towels. After cooking, let stand 2 minutes.
Zucchini Fresh, sliced (1 lb.) 4 cups	High 7-8 minutes	Place zucchini and 2 tablespoons water in 1½-quart microwavable covered casserole. Stir halfway through cooking. Let stand covered 2 minutes.

**NOTE:** Frozen vegetables in larger or smaller quantities than listed in the chart or those in non-microwavable bags may be cooked approximately 3 to 4 minutes per cup of vegetables. Measure desired amount of vegetables into microwavable covered casserole and cook.

# APPENDIX

## REHEATING TABLE

To heat or reheat successfully in the microwave, it is important to follow several guidelines. Measure the amount of food in order to determine the time needed to reheat. Arrange the food in a circular pattern for best results. Room temperature food will heat faster than refrigerated food. Canned foods should be taken out of the can and placed in a microwavable container. The food will heat more evenly if covered with a microwavable lid or vented plastic wrap. Remove cover carefully to prevent steam burns. Use the following chart as a guide for reheating cooked food.

Items	Cook Power	Cooking Time	Special Instructions
Sliced meat 3 slices (1/4-inch thick).	High	1 to 1½ minutes	Place sliced meat on microwavable plate. Cover with plastic wrap and vent. * NOTE: Gravy or sauce helps to keep meat juicy.
Chicken pieces 1 breast 1 leg and thigh	High	3 to 4 minutes 3 to 4 minutes	Place chicken pieces on microwavable plate. Cover with plastic wrap and vent. Let stand 1 minute.
Fish fillet (6-8 oz.)	High	1½ to 2 minutes	Place fish on microwavable plate. Cover with plastic wrap and vent.
Lasagna 1 serving (10½ oz.)	High	3 to 4 minutes	Place lasagna on microwavable plate. Cover with plastic wrap and vent.
Casserole 1 cup 4 cups	High	2 to 2½ minutes 9 to 10 minutes	Cook covered in microwavable casserole; stir once halfway through cooking.
Casserole cream or cheese 1 cup 4 cups	High	2 to 2½ minutes 7 to 8 minutes	Cook covered in microwavable casserole; stir once halfway through cooking.
Sloppy Joe or barbecued beef 1 sandwich (½ cup meat filling) without bun	High	1½ to 2½ minutes	Reheat filling and bun separately. Cook filling covered in microwavable casserole; stir once. Heat bun as directed in chart below.
Mashed potatoes 1 cup 4 cups	High	1 to 1½ minutes 6½ to 7½ minutes	Cook covered in microwavable casserole; stir once halfway through cooking.
Baked beans 1 cup	High	3 to 4 minutes	Cook covered in microwavable casserole; stir once halfway through cooking.

# WHIRLPOOL® Microwave Oven Warranty

MW002

LENGTH OF WARRANTY	WHIRLPOOL WILL PAY FOR
<b>FULL ONE-YEAR WARRANTY</b> From Date of Purchase	FSP® replacement parts and repair labor to correct defects in materials or workmanship. Service must be provided by an authorized Whirlpool <sup>SM</sup> service company.
<b>LIMITED FOUR-YEAR WARRANTY</b> Second Through Fifth Year From Date of Purchase	FSP® replacement magnetron tube on microwave ovens if defective in materials or workmanship.
<b>WHIRLPOOL WILL NOT PAY FOR</b>	
<p><b>A.</b> Service calls to:</p> <ol style="list-style-type: none"> <li>1. Correct the installation of the microwave oven.</li> <li>2. Instruct you how to use the microwave oven.</li> <li>3. Replace house fuses or correct house wiring.</li> <li>4. Replace owner accessible light bulbs.</li> </ol> <p><b>B.</b> Repairs when microwave oven is used in other than normal, single-family household use.</p> <p><b>C.</b> Pick-up and delivery. This product is designed to be repaired in the home.</p> <p><b>D.</b> Damage to microwave oven caused by accident, misuse, fire, flood, acts of God or use of products not approved by Whirlpool.</p> <p><b>E.</b> Any labor costs during limited warranties.</p>	

WHIRLPOOL CORPORATION SHALL NOT BE LIABLE FOR INCIDENTAL OR CONSEQUENTIAL DAMAGES. Some states do not allow the exclusion or limitation of incidental or consequential damages so this limitation or exclusion may not apply to you. This warranty gives you specific legal rights, and you may also have other rights which vary from state to state.

Outside the United States, a different warranty may apply. For details, please contact your franchised Whirlpool distributor or military exchange.

If you need service, first see the "Service and Assistance" section of this book. After checking "Service and Assistance," additional help can be found by calling our COOL-LINE® service assistance telephone number, **1-800-253-1301**, from anywhere in the U.S.

® Registered Trademark/SM Service Mark of Whirlpool Corporation.