

WASHER INSTALLATION INSTRUCTIONS

Table of Contents

WASHER SAFETY	1
INSTALLATION REQUIREMENTS	2
Tools and Parts	2
Location Requirements	2
Drain System	3
Electrical Requirements	3
INSTALLATION INSTRUCTIONS	4
Before You Start	4
Remove Shipping Materials	4
Connect Drain Hose	5
Connect the Inlet Hoses	6
Secure the Drain Hose	7
Level the Washer	7
Complete Installation	8

WASHER SAFETY

Your safety and the safety of others are very important.

We have provided many important safety messages in this manual and on your appliance. Always read and obey all safety messages.



This is the safety alert symbol.

This symbol alerts you to potential hazards that can kill or hurt you and others.

All safety messages will follow the safety alert symbol and either the word "DANGER" or "WARNING."

These words mean:

⚠ DANGER

You can be killed or seriously injured if you don't immediately follow instructions.

⚠ WARNING

You can be killed or seriously injured if you don't follow instructions.

All safety messages will tell you what the potential hazard is, tell you how to reduce the chance of injury, and tell you what can happen if the instructions are not followed.

INSTALLATION REQUIREMENTS

Tools and Parts

Gather the required tools and parts before starting installation. The parts supplied are in the washer basket.

Tools needed for connecting the drain hose and water inlet hoses:

- Pliers that open to 3.95 cm (1 $\frac{9}{16}$ ")
- Flashlight (optional)
- Flat-blade screwdriver

Parts supplied:

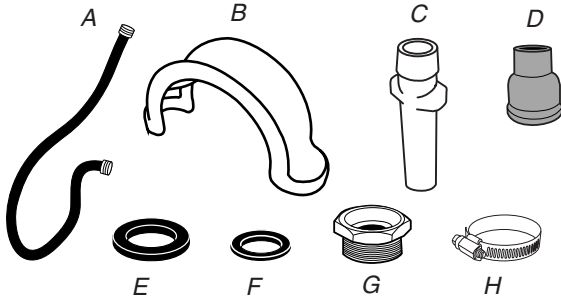

- A. Water inlet hose (2)
- B. Drain hose form
- C. Drain hose extension
- D. Drain hose coupling
- E. Large flat washer (4)
- F. Small flat washer (2)
- G. Inlet hose adapter (2)
- H. Hose clamp (2)

Tools needed for securing the drain hose and leveling the washer:

- Adjustable or open end wrench 14 mm ($\frac{9}{16}$ ")
- Wood block
- Level
- Ruler or measuring tape

Parts supplied:

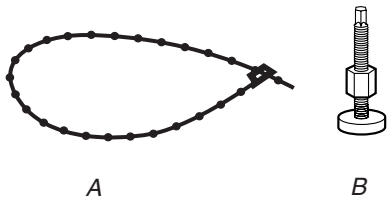

- A. Beaded tie strap
- B. Front leveling feet with nuts (2)

Alternate Parts

Your installation may require additional parts. For information on ordering, contact your dealer.

If You Have:	You Will Need to Buy:
Laundry tub or standpipe taller than 2.4 m (96")	Sump pump system (if not already available)
Overhead sewer	Standard 76 l (20 gal.) 99 cm (39") tall drain tub or utility sink, sump pump and connectors (available from local plumbing suppliers)
Floor drain	Siphon break kit, Part Number 280129; additional drain hose, Part Number 3357090
Water taps beyond reach of fill hoses	2 longer water fill hoses: 1.8 m (6 ft) Part Number 76314, 3.0 m (10 ft) Part Number 350008
Drain hose too short	Drain hose kit, Part Number 280131
Lint clogged drain	Drain protector, Part Number 367031

Location Requirements

Selecting the proper location for your washer improves performance and minimizes noise and possible washer "walk."

Your washer can be installed in a basement, laundry room, closet, or recessed area. See "Drain System."

IMPORTANT: Do not install or store the washer where it will be exposed to the weather.

Proper installation is your responsibility.

You will need:

- A water heater set to deliver 60°C (140°F) water to the washer.
- An earthed electrical outlet located within 1.2 m (4 ft) of where the power cord is attached to the back of the washer. See "Electrical Requirements."
- Hot and cold water taps located within 90 cm (3 ft) of the hot and cold water fill valves, and water pressure of 34.5-690 kPa (5-100 psi). Washers with triple dispensers require 138-690 kPa (20-100 psi) for best performance.
- A level floor with a maximum slope of 2.5 cm (1") under entire washer. Installing the washer on carpeting is not recommended. Ventilation openings in the base must not be obstructed by carpet.
- A sturdy floor to support the washer weight (washer, water and load) of 143 Kg (315 lbs).

Do not store or operate your washer in temperatures at or below 0°C (32°F). Some water can remain in the washer and can cause damage in low temperatures.

Recessed area or closet installation

The dimensions shown are for the recommended spacing allowed (A and B), except the closet door ventilation openings. The dimensions shown for the closet door ventilation openings (C) are the minimum required.

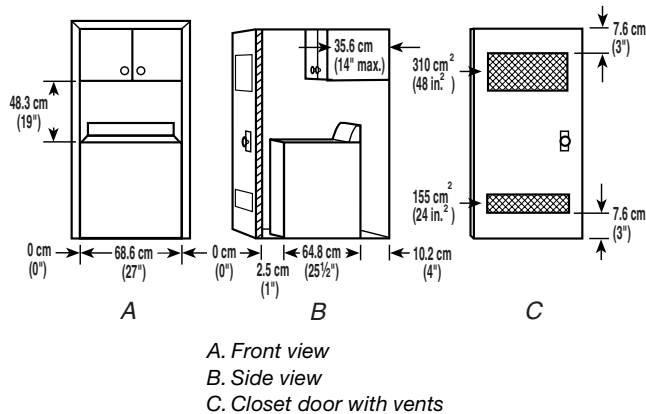

- Additional spacing should be considered for ease of installation and servicing.
- Additional clearances may be required for wall, door and floor moldings.
- Additional spacing of 2.5 cm (1") on all sides of the washer is recommended to reduce noise transfer.
- If a closet door is installed, the minimum air openings in the top and bottom of the door are required (C). Louvered doors with air openings in the top and bottom are acceptable.
- Companion appliance spacing should also be considered.

Drain System

The washer can be installed using the standpipe drain system (floor or wall), the laundry tub drain system, or the floor drain system. Select the drain hose installation method you need. See "Tools and Parts."

Standpipe drain system - wall or floor (views A & B)

The standpipe drain requires a minimum diameter standpipe of 5 cm (2"). The minimum carry-away capacity can be no less than 64 l (17 gal.) per minute. A 3.2 cm (1 1/4") diameter to 2.5 cm (1") diameter standpipe adapter kit is provided.

The top of the standpipe must be at least 99 cm (39") high and no higher than 244 cm (96") from the bottom of the washer. Additional hoses may be needed.

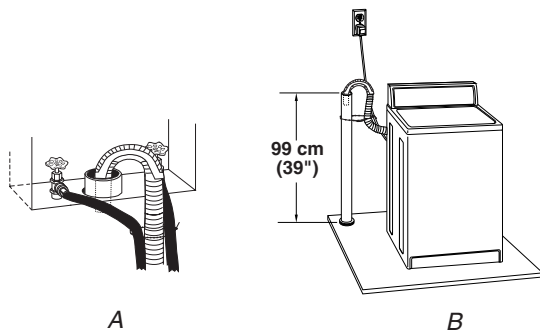

Laundry tub drain system (view C)

The laundry tub needs a minimum 76 l (20 gal.) capacity. The top of the laundry tub must be at least 99 cm (39") above the floor and no higher than 244 cm (96") from the bottom of the washer.

Floor drain system (view D)

The floor drain system requires a siphon break that may be purchased separately. See "Tools and Parts."

The siphon break must be a minimum of 71 cm (28") from the bottom of the washer. Additional hoses might be needed.

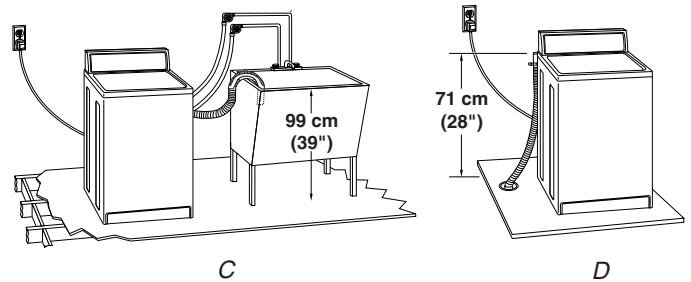

Electrical Requirements

⚠ WARNING



Electric Shock Hazard

Electrically earth this appliance.

Do not use an extension cord or an electrical portable outlet device.

Failure to follow these instructions can result in death, fire or electric shock.

- A 230 volt, 50 Hz., AC only, 10-amp, fused electricity supply is required. A time-delay fuse or circuit breaker is recommended. It is recommended that a separate circuit serving only this appliance be provided.
- This washer is equipped with a power supply cord having an earthing plug.
- To minimize possible shock hazard, the cord must be plugged into a mating, earthing-type outlet, earthed in accordance with local codes and ordinances. If a mating outlet is not available, it is the personal responsibility and obligation of the customer to have the properly earthed outlet installed by a qualified electrician.
- If codes permit and a separate earth wire is used, it is recommended that a qualified electrician determine that the earth path is adequate.
- Do not earth to a gas pipe.

- Check with a qualified electrician if you are not sure the washer is properly earthed.
- Do not have a fuse in the neutral or earth circuit.
- When in the installed position the mains plug must be accessible for disconnection.

EARTHING INSTRUCTIONS

This washer must be earthed. In the event of a malfunction or breakdown, earthing will reduce the risk of electrical shock by providing a path of least resistance for electric current. This washer is equipped with a cord having an equipment-earthing conductor and an earthing plug. The plug must be plugged into an appropriate outlet that is properly installed and earthed in accordance with all local codes and ordinances.

WARNING: Improper connection of the equipment-earthing conductor can result in a risk of electric shock. Check with a qualified electrician or serviceman if you are in doubt as to whether the appliance is properly earthed.

Do not modify the plug provided with the appliance – if it will not fit the outlet, have a proper outlet installed by a qualified electrician.

INSTALLATION INSTRUCTIONS

Before You Start

⚠ WARNING

Excessive Weight Hazard

**Use two or more people to move and install washer.
Failure to do so can result in back or other injury.**

NOTE: To avoid floor damage, set the washer onto cardboard before moving across floor.

Remove Shipping Materials

Removing the shipping material is necessary for proper operation. If the shipping material is not removed, the washer will make excessive noise.

1. Move the washer to within approximately 90 cm (3 ft) of its final location.
2. The washer must be in the upright position and not tilted before removing the shipping material.
3. Locate the yellow shipping materials on the rear of the machine, near the bottom. Follow the steps for your particular model, either the one with the straight power cord and cord restraint or the looped power cord version.

Straight power cord

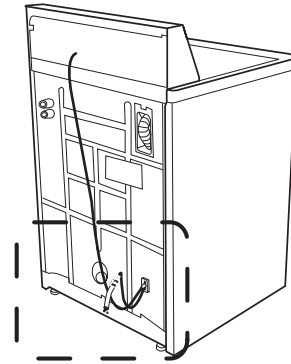

Straight power cord

1. Remove power plug and yellow strap from machine base to release the rear leveling system.

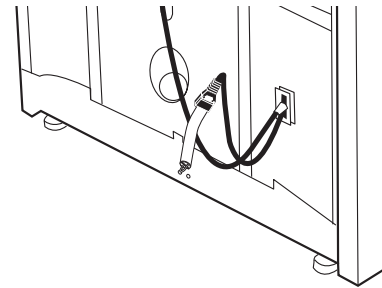

2. Firmly grasp the power cord and pull to completely remove the power cord, cord restraint, and pin from the rear panel.

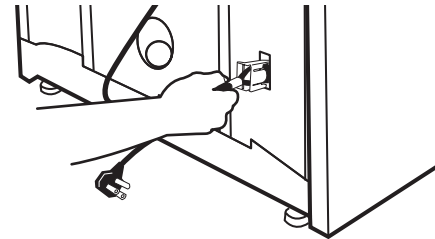

3. Confirm that the power cord restraint (A), and pin (B) are removed.

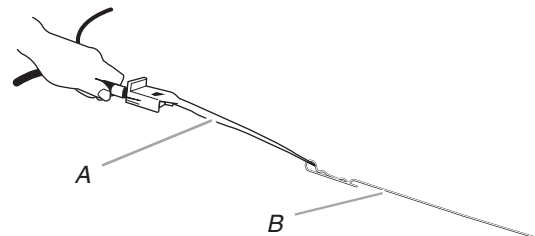

A. Power cord restraint B. Pin

- To remove the power cord from the cord restraint, push the power cord in, press TAB, and then pull the power cord out.

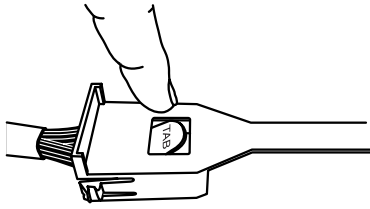

Looped power cord

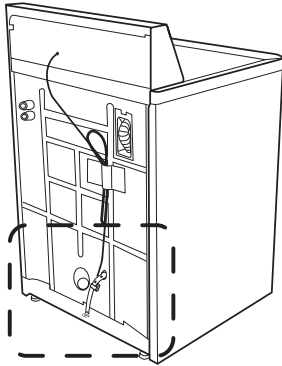

Looped power cord

- Firmly grasp the yellow shipping strap and pull until both ends are completely removed from washer.

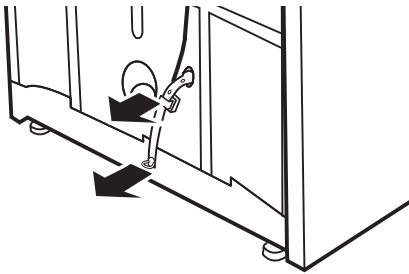

- Check that two (2) shipping pins were removed with the shipping strap.

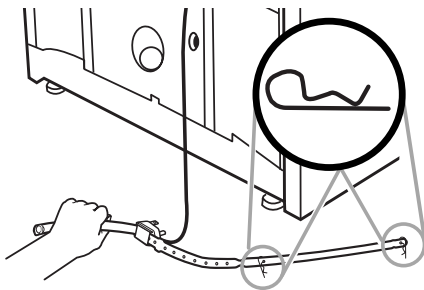

Connect Drain Hose

Proper connection of the drain hose protects your floors from damage due to water leakage. Read and follow these instructions. The drain hose is connected to your washer and is stored inside the washer cabinet.

Remove drain hose from washer cabinet

Gently pull the corrugated drain hose out of the washer from the top of the hose. Continue to pull the hose until the end emerges. Do not force excess drain hose back into the rear of the washer.

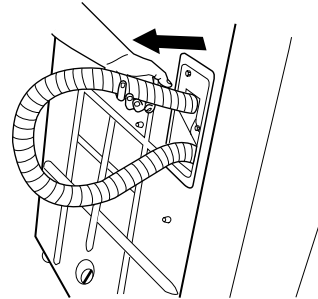

Laundry tub drain or standpipe drain

Connecting the drain hose form to the corrugated drain hose

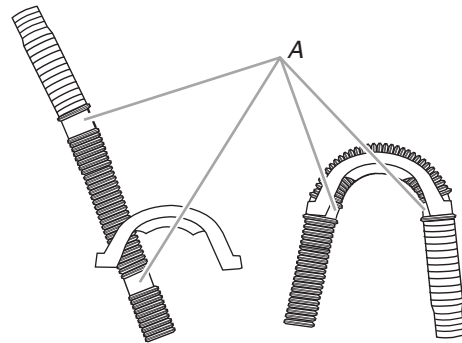

A. Drain hose reliefs

- Feed end of drain hose into one end of form. Place end of drain hose form into the drain hose relief.
- Bend the hose over the top of the form and feed into the other end of the form.

If drain hose does not fit into standpipe or if you are placing the drain hose over the edge of a laundry tub:

- Place coupling on end of drain hose. Use a screwdriver to install hose clamp.
- Then slide the second hose clamp onto coupling. Insert end of adapter into coupling. Use a screwdriver to install second hose clamp over coupling.

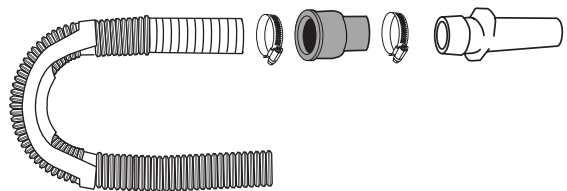

To keep drain water from going back into the washer:

- Do not force excess drain hose into standpipe. Hose should be secure but loose enough to provide a gap for air.
- Do not lay excess hose on the bottom of the laundry tub.

Floor drain

Do not install the drain hose form on to the corrugated drain hose. You may need additional parts. See Floor drain under "Tools and Parts."

Connect the Inlet Hoses

1. The new inlet hoses supplied with this machine must be used. Do not re-use old inlet hoses.
2. Insert one new large flat washer into one end of each inlet hose. Firmly seat the washers in the couplings.
3. Screw on the hose adapter by hand until it is seated on the washer. Using pliers, tighten the hose adapter with an additional two-thirds turn.

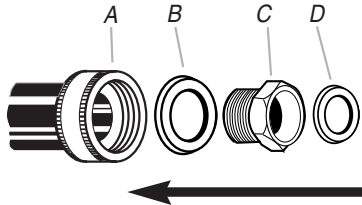

A. Inlet hose coupling C. Hose adapter
B. Large flat washer D. Small flat washer

NOTE: Do not overtighten.

4. Insert one new small flat washer into the end of the hose adapter. Firmly seat the washers in the couplings.

Connect the inlet hoses with the adapters, to the water taps

Make sure the washer basket is empty.

1. Attach the end of the hose with the adapter, labeled hot, to the hot water tap. Screw on coupling by hand until it is seated on the washer.
2. Attach the end of the hose with the adapter, labeled cold, to the cold water tap. Screw on coupling by hand until it is seated on the washer.
3. Using pliers, tighten the couplings with an additional two-thirds turn.

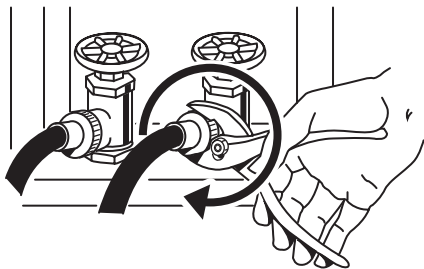

Tighten the couplings with an additional two-thirds turn.

NOTE: Do not overtighten or use tape or sealants on the valve. Damage to the valves can result.

Clear the water lines

1. Run water through both taps and inlet hoses, into a laundry tub, drainpipe or bucket, to get rid of particles in the water lines that might clog the inlet valve filters.
2. Check the temperature of the water to make sure that the hot water hose is connected to the hot water tap and that the cold water hose is connected to the cold water tap.

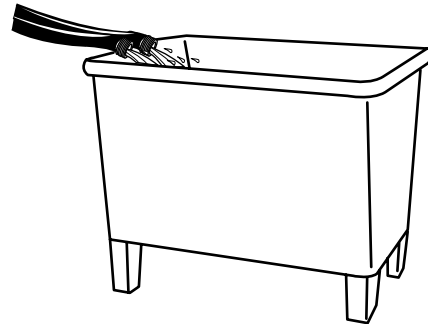

3. Insert new large flat washers (supplied) into each end of the inlet hoses. Firmly seat the washers in the couplings.

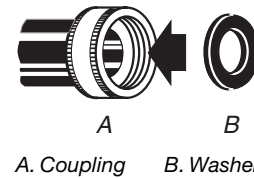

A. Coupling B. Washer

Connect the inlet hoses to the washer

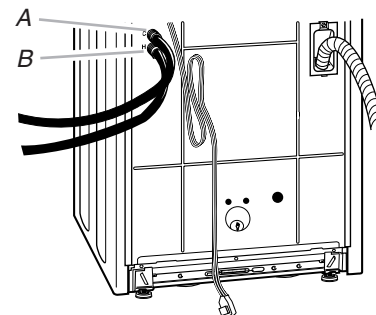

A. Cold water inlet valve
B. Hot water inlet valve

1. Attach the hot water hose to the bottom inlet valve.
2. Attaching the hot water coupling first makes it easier to tighten connection with pliers.
3. Screw on coupling by hand until it is seated on the washer.

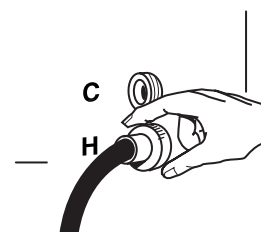

- Using pliers, tighten the couplings with an additional two-thirds turn.
NOTE: Do not overtighten or use tape or sealants on the valve. Damage to the valves can result.

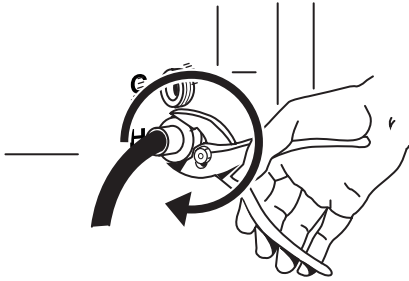

- Attach the cold water hose to the top inlet valve.
- Screw on coupling by hand until it is seated on the washer.
- Using pliers, tighten the couplings with an additional two-thirds turn.
NOTE: Do not overtighten or use tape or sealants on the valve. Damage to the valves can result.

Check for leaks

Turn on the water taps and check for leaks. A small amount of water might enter the washer. You will drain this later.

NOTE: Replace inlet hoses after 5 years of use to reduce the risk of hose failure. Record hose installation or replacement dates for future reference.

- If you connect only one water hose, you must cap off the remaining water inlet port.
- Periodically inspect and replace hoses if bulges, kinks, cuts, wear, or leaks are found.

Secure the Drain Hose

- Remove the shipping material from the power cord. Drape the power cord over the console.
- Remove any cardboard used to move washer.



Beaded tie strap

- Wrap the drain hose to the laundry tub leg, drain standpipe or inlet hoses, with the beaded tie strap. Push fastener into the nearest hole in the beaded tie strap. See view A or B.

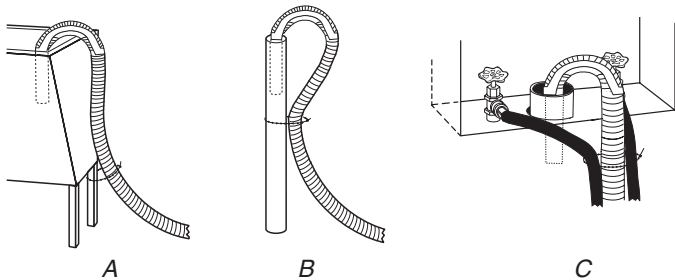

If the washer taps and the drain standpipe are recessed, put the formed end of the drain hose into the standpipe. Tightly wrap the tie strap around the water inlet hoses and the drain hose. See view C.

Level the Washer

Properly leveling your washer avoids excessive noise and vibration.

Install the Front Leveling Feet

- Prop up the front of the washer about 10.2 cm (4") with a wood block or similar object. The block needs to support the weight of the washer.

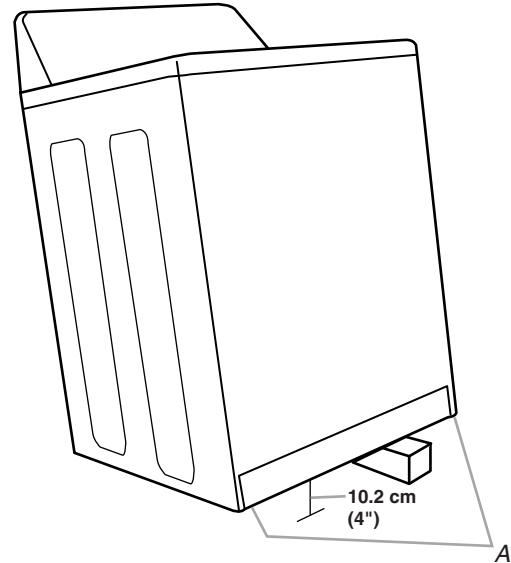

A. Threaded holes for feet

- Screw the locknut onto each foot to within 2.5 cm (1") of the foot base.

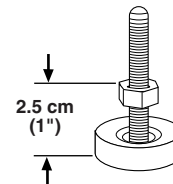

- Screw the feet into the threaded holes at the front corner of the washer until the nuts touch the washer. Twist the feet to install.

NOTE: Do not tighten the nuts until the washer is level.

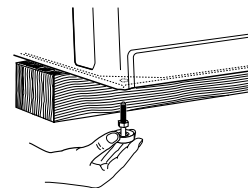

- Tilt the washer back and remove the wood block. Gently lower the washer to the floor.

Steps in Final Location

1. Slide the washer to its final location.
2. Tilt the washer forward until the rear of the washer is at least 10.2 cm (4") off the floor. You may hear the self-adjusting rear feet click into place. Lower the washer to the floor.

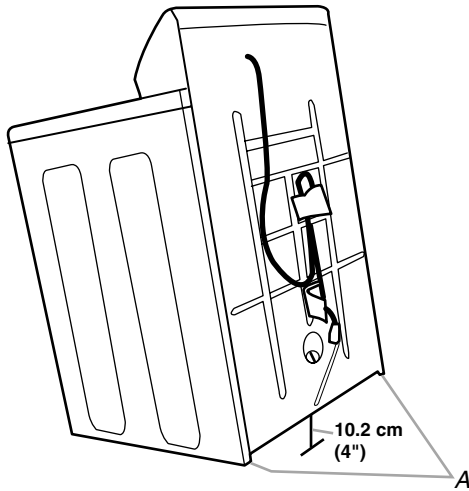

A. Self-adjusting feet

3. Check the levelness of the washer by placing a level on the top edges of the washer, first side to side, then front to back.

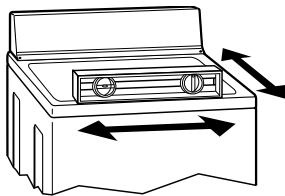

4. If the washer is not level, move the washer out slightly, tip back, prop up the front of the washer with the wood block and adjust the feet up or down as necessary by twisting the feet. Turn the feet clockwise to raise the washer or counterclockwise to lower the washer. Repeat steps 1 through 4 until washer is level.

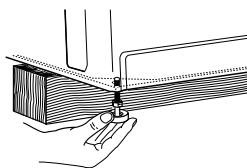

5. After the washer is in its final location and level, use a 14 mm or 9/16" open-end wrench to turn the nuts counterclockwise on the feet tightly against the washer cabinet.

IMPORTANT: If the nuts are not tight against the washer cabinet, the washer may vibrate.

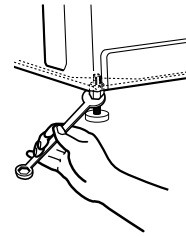

Complete Installation

1. Check the electrical requirements. Be sure that you have the correct electrical supply and the recommended earthing method. See "Electrical Requirements."
2. Check that all parts are now installed. If there is an extra part, go back through the steps to see which step was skipped.
3. Check that you have all of your tools.
4. Check that the yellow shipping strap was completely removed from the lower back of the washer.
5. Dispose of/recycle all packaging materials.
6. Check that the water taps are on.
7. Check for leaks around taps and inlet hoses.

⚠ WARNING



Electric Shock Hazard

Electrically earth this appliance.

Do not use an extension cord or an electrical portable outlet device.

Failure to follow these instructions can result in death, fire or electric shock.

8. Plug into an earthed outlet.
9. Remove the protective film on the console and any tape remaining on the washer.
10. Remove the protective film on the console and any tape remaining on the washer.
11. To test and to clean your washer, measure ½ of the normal recommended amount of powdered or liquid detergent and pour it into the washer basket or detergent dispenser (on some models). Close the lid. Select any cycle, and then pull the Cycle Control knob out to start the washer. Allow it to complete one whole cycle.