

GE Monogram®

Use and Care Guide

Component

Cooktop System

Introduction

Your new Monogram cooktop makes an eloquent statement of style, convenience and kitchen planning flexibility. Whether you chose it for its purity of design, assiduous attention to detail—or for both of these reasons—you’ll find that your Monogram cooktop’s superior blend of form and function will delight you for years to come.

Your Monogram cooktop was designed to provide the flexibility to blend in with your kitchen cabinetry. Its sleek design can be beautifully integrated into the kitchen.

The information on the following pages will help you operate and maintain your cooktop properly.

If you have any other questions—please call the GE Answer Center® 800.626.2000.

Contents

Care and Cleaning

Brushed Stainless Steel Finish 23
 Care of Components 23–28
 Control Panel and Knobs 23
 Gas Burner Assembly 26
 Grease Jars 27
 Grill Component 27
 Halogen/Radiant Cooktop 24, 25
 Porcelain Enamel Grease Well 27
 Vent Filters 28
 Vent Grille 28
 Vent System 28

Consumer Services

Important Phone Numbers 33, 36
 Model and Serial Number 3, 36
 Problem Solver 29–31
 Product Registration 35, 36
 Safety Instructions 4–7
 Warranty 34

Using Your Cooktop

Gas Burner Component 15–17
 Grill Component 18–21
 Halogen/Radiant Component 10–13
 Home Canning Tips 14
 Optional Components 8, 9
 Vent System 22



WARNING: If the information in this guide is not followed exactly, a fire or explosion may result causing property damage, personal injury or death.

- Do not store or use gasoline or other flammable vapors and liquids in the vicinity of this or any other appliance.
- **WHAT TO DO IF YOU SMELL GAS**
 - Do not try to light any appliance.
 - Do not touch any electrical switch; do not use any phone in your building.
 - Immediately call your gas supplier from a neighbor’s phone. Follow the gas supplier’s instructions.
 - If you cannot reach your gas supplier, call the fire department.
- Installation and service must be performed by a qualified installer, service agency or the gas supplier.

*Before
using your
cooktop
system*

Read this guide carefully. It is intended to help you operate and maintain your new cooktop components properly.

Keep it handy for answers to your questions.

If you don't understand something or need more help, call:

GE Answer Center®
800.626.2000
24 hours a day, 7 days a week

*Write
down the
model &
serial
numbers*

You'll find them on a label on the bottom of each component.

These numbers are also on the Consumer Product Ownership Registration Card included in this guide.

Before sending in this card, please write these numbers here:

Model Number

Serial Number

Use these numbers in any correspondence or service calls concerning your cooktop.

*If you
received
damaged
components*

Immediately contact the dealer (or builder) that sold you the cooktop system.

*Save time
& money*

Before you request service, check the Problem Solver in the back of this guide.

It lists causes of minor operating problems that you can correct yourself.

*If you
need
service*

To obtain service, see the Consumer Services page in the back of this guide.

We're proud of our service and want you to be pleased. If for some reason you are not happy with the service you receive, here are three steps to follow for further help.

FIRST, contact the people who serviced your appliance. Explain why you are not pleased. In most cases, this will solve the problem.

NEXT, if you are still not pleased, write all the details—including your phone number—to:

Manager, Consumer Relations
GE Appliances
Appliance Park
Louisville, KY 40225

FINALLY, if your problem is still not resolved, write:

Major Appliance Consumer
Action Program
20 North Wacker Drive
Chicago, IL 60606

IMPORTANT SAFETY INSTRUCTIONS

IMPORTANT SAFETY NOTICE

- **The California Safe Drinking Water and Toxic Enforcement Act** requires the Governor of California to publish a list of substances known to the state to cause cancer, birth defects or other reproductive harm, and requires businesses to warn customers of potential exposure to such substances.
- **Gas appliances can cause minor exposure to four of these substances**, namely benzene, carbon monoxide, formaldehyde and soot, caused primarily by the incomplete combustion of natural gas or LP fuels.

Properly adjusted burners, indicated by a bluish rather than a yellow flame, will minimize incomplete combustion. Exposure to these substances can be minimized further by venting with an open window or using a ventilation fan or hood.

SAFETY PRECAUTIONS

When using the component cooktop system, basic safety precautions should be followed, including the following:

- **Use this cooktop system only for its intended use** as described in this guide.
- **If the cooktop is located near a window**, do not use long curtains, which could blow over the gas burners or surface units, creating a fire hazard.
- **Have your cooktop installed and properly grounded by a qualified installer** in accordance with the Installation Instructions. Any adjustment and service should be performed only by qualified gas and electric appliance installers or service technicians.
- **Have the installer show you the location of the circuit breaker or fuse.** Mark it for easy reference.
- **Have the installer show you the location of the gas cut-off valve and how to shut it off if necessary.**
- **Do not attempt to repair or replace any part of the component cooktop system unless it is specifically recommended in this guide.** Any adjustment and service should be performed only by qualified electric and gas range installers or service technicians.
- **BEFORE PERFORMING ANY SERVICE, DISCONNECT THE COOKTOP SYSTEM POWER SUPPLY AT THE HOUSEHOLD DISTRIBUTION PANEL BY REMOVING THE FUSE OR SWITCHING OFF THE CIRCUIT BREAKER.**
- **Do not leave children alone**—children should not be left alone or unattended in an area where an appliance is in use. They should never be allowed to sit or stand on any part of the cooktop system.
- **Avoid installing cabinets above the cooktop system.**
- **To reduce the hazard caused by reaching into cabinets over hot surface units, the open flames of operating burners and hot cookware, install a metal ventilation hood over the cooktop components that projects forward at least 5 inches beyond the front of the cabinets.**
- **If cabinets are placed above the cooktop components, allow a minimum clearance of 30 inches between the cooking surface and the bottom of unprotected cabinets.**

SAFETY PRECAUTIONS

- **CAUTION: ITEMS OF INTEREST TO CHILDREN SHOULD NOT BE STORED IN CABINETS INSTALLED ABOVE THE COOKTOP SYSTEM—CHILDREN CLIMBING ON THE COOKTOP SYSTEM TO REACH ITEMS COULD BE SERIOUSLY INJURED.**
- **Never wear loose-fitting or hanging garments while using the cooktop system.** Be careful when reaching for items stored in cabinets over the cooktop system. Flammable material could be ignited if brought in contact with hot surface units or gas burners and may cause severe burns.
- **Use only dry pot holders—**moist or damp pot holders on hot surfaces may result in burns from steam. Do not let pot holders touch the hot surface units or gas burners and grates. Do not use a towel or other bulky cloth in place of a pot holder.
- **For your safety, never use any electric or gas components of the cooktop system for warming or heating the room.**
- **Do not store flammable materials in an oven or near the cooktop system components.**
- **Do not store or use combustible materials, gasoline or other flammable vapors and liquids in the vicinity of this or any other gas or electric appliance.**
- **Do not let cooking grease or other flammable materials accumulate in or near the cooktop system components.**
- **Never leave the kitchen while using the grill.**
- **Do not replace the grease collector jar with a mayonnaise jar** which could break when hot grease drips into it. Replace with any wide mouth canning jar.
- **Do not use water on grease fires. Never pick up a flaming pan.** Turn the controls off. Smother a flaming pan on a surface unit by covering the pan completely with a well-fitting lid, cookie sheet or flat tray. Use a multi-purpose dry chemical or foam-type fire extinguisher.

Flaming grease outside a pan can be put out by covering it with baking soda or, if available, by using a multi-purpose dry chemical or foam-type fire extinguisher.
- **Keep the grill drip pan and grease well clean to reduce smoking and avoid grease fires.**
- **To control flame-ups, turn down the heat setting to low, rather than off (O).** This keeps the downdraft vent blower on. Or, turn the Variable Speed Vent blower to HI, then turn the grill off (O).

Use a long-handled utensil to carefully remove the food from the grill.

These steps should control the flame until it eventually goes out. If it does not, cover the entire grill module with a cookie sheet or the lid from a large roasting pan. Use a pot holder to remove this later because it will be hot.
- **Do not touch the surface units.** These surfaces may be hot enough to burn even though they are dark in color. During and after use, do not touch, or let clothing or other flammable materials contact the surface units, cooktop surfaces or areas nearby the surface units. Allow sufficient time for cooling of the cooking surfaces.

Potentially hot surfaces include the grill grates and all components with electric cooking elements or gas burners and grates.
- **When cooking pork,** follow the directions exactly and always cook the meat to an internal temperature of at least 170°F. This assures that, in the remote possibility that trichina may be present in the meat, it will be killed and the meat will be safe to eat.

IMPORTANT SAFETY INSTRUCTIONS

USING YOUR COMPONENT COOKTOP

- **Use proper pan size**—this cooktop system has components equipped with electric surface units or gas burners. Select cookware having flat bottoms large enough to cover the selected surface unit or burner. The use of undersized cookware will expose portions of the surface units or gas burners to direct contact and may result in ignition of clothing. Proper relationship of cookware to the surface unit or the burner will also improve efficiency.
- **Only certain types of glass, glass/ceramic, earthenware or other glazed containers are suitable for cooktop service;** others may break because of the sudden change in temperature.
- **Never leave the surface units or gas burners unattended at high heat settings.** Boilovers cause smoking and greasy spillovers that may catch fire.
- **To minimize the possibility of burns,** ignition of flammable materials and spillage, the handles of cookware should be turned without extending over nearby surface units or burners.
- **Always turn the electric surface unit or gas burner controls off (O) before removing the cookware.**
- **Watch foods being fried at high or medium-high heat settings.**
- **When flaming foods are under the exhaust hood, turn the hood fan off. The hood fan, if operating, may spread the flame.**
- **Foods for frying should be as dry as possible.** Frost on frozen foods or moisture on fresh foods can cause hot fat to bubble up and over the sides of the pan.
- **Use little fat for effective shallow or deep fat frying.** Filling the pan too full of fat can cause spillovers when food is added.
- **If a combination of oils or fats will be used in frying,** stir together before heating, or as fats melt slowly.
- **Always heat fat slowly,** and watch as it heats.
- **Use a deep-fat thermometer whenever possible** to prevent overheating fat beyond the smoking point.
- **Be sure the downdraft vent grille is not covered. Be sure the filter is in place.** Its absence during cooking could damage blower parts.
- **Do not cover or block the area around the cooktop system knobs.** This area must be kept clear for proper ventilation and burner performance.
- **Keep all plastics away from cooktop surface units and burners.**
- **Do not operate the halogen/radiant surface units if the glass is broken.** Spillovers or cleaning solution may penetrate a broken cooktop and create a risk of electrical shock. Contact a qualified technician immediately should your glass cooktop become broken.
- **Avoid scratching the glass cooktop surface.** The cooktop can be scratched with items such as sharp instruments, rings or other jewelry and rivets on clothing.
- **Never use the glass cooktop surface as a cutting board.**
- **Do not place or store items on top of the glass cooktop surface when it is not in use.**
- **Do not stand on the glass cooktop.**
- **Be careful when placing spoons or other stirring utensils on the glass cooktop surface** when it is in use. They may become hot and could cause burns.
- **Use care when touching the cooktop.** The glass surface of the cooktop will retain heat after the controls have been turned off.
- **To avoid possible damage to the cooking surface,** do not apply Cooktop Cleaning Cream to the glass surface when it is hot.

USING YOUR COMPONENT COOKTOP

- **After cleaning**, use a dry cloth or paper towel to remove all Cooktop Cleaning Cream residue.
- **Read and follow all instruction and warnings on Cooktop Cleaning Cream labels.**
- **Clean the cooktop with caution.** If a wet sponge or cloth is used to wipe spills on a hot surface unit, be careful to avoid steam burns. Some cleaners can produce noxious fumes if applied to a hot surface.

When the cooktop is cool, use only Cooktop Cleaning Cream brand cleaner to clean the cooktop.
- **Do not use a wok on the gas burners if the wok has a round metal ring which is placed over the burner grate to support the wok.** This ring acts as a heat trap that may damage the burner grate and burner head. Also, it may cause the burner to work improperly. This may cause a carbon monoxide level above that allowed by current standards, resulting in a health hazard.
- **If you smell gas**, turn off the gas to the cooktop at the gas cutoff valve and call a qualified service technician. Never use an open flame to locate a leak.
- **Do not operate the gas burners without all burner parts and grate in place.**
- **Let the gas burner grate and other surfaces cool before touching them.**
- **Do not leave grates removed from any component where children can reach them.**
- **Never leave gas burners unattended at high flame settings.** Boilovers cause smoking and greasy spillovers that may catch on fire.
- **For your safety, never use your gas burners for warming or heating the room.** Prolonged use of the cooktop in this way can be hazardous.
- **Do not clean the cooktop system with flammable or volatile cleaning fluids.** See the Care and Cleaning section.
- **Do not clean any part of the cooktop system when the appliance is in use.**
- **If you are using an overhead exhaust hood, keep its grease filters clean** to maintain good venting and to avoid grease fires.
- **Clean only parts listed in this Use and Care Guide.**
- **Clean the cooktop with caution.** If a wet sponge or cloth is used to wipe spills on a hot cooktop, be careful to avoid steam burns.

SAVE THESE INSTRUCTIONS

Optional Components

Component Cooktop System

General information

Some of the components must be cured or preconditioned before using them for the first time.

Components and accessories should be cleaned after each use. The longer a soil remains, the harder it is to clean. See each component section in the Care and Cleaning section for specific instructions.

Never immerse any electric surface unit or plug in water.

Components available are discussed in this section. You may only have some installed in your kitchen. All components are permanently installed with the exception of the grill.

Read each component section for specific instructions.

To purchase additional components, contact your nearest GE Appliances dealer or service center. Part numbers for additional components are listed in this guide.

Electric surface unit components

You must consider heat up and cool down times for the surface units when determining cooking times. Heat up and cool down times depend on initial temperature settings, the type of cookware used and the amount of food being cooked.

Start cooking at a higher setting to heat the surface unit faster, then turn to a lower setting to finish cooking.

Remember, cooking continues after the surface unit is turned off, so train yourself to turn the heat down or off before cooking is done.

Gas components

Monogram component gas cooktops (used with either updraft or downdraft venting) are designed to operate on natural gas at 4" water column pressure.

Downdraft vent

The downdraft vent component features an integral variable-speed blower control switch and a powerful centrifugal blower.

Halogen/radiant cooktop

Part Number:
ZEW145

The component has one 8" 1800 watt halogen surface unit (rear) and a 6" 1200 watt radiant surface unit (front).

There is a hot surface light for each surface unit that indicates the condition of the glass surface.

The heat up time for the halogen surface unit may be less compared to the radiant surface unit depending upon the control settings. See the Controls section for additional performance characteristics.

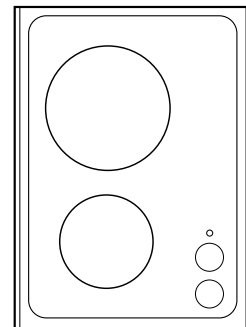

Gas burner cooktop

This component has one large 10,500-BTU burner (rear) and one smaller 6,000-BTU burner (front). The grate is removable for cleaning.

Part Numbers:

ZGW124—right controls

ZGW125—left controls

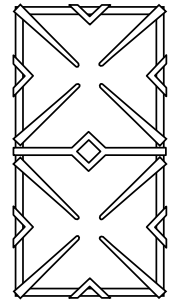
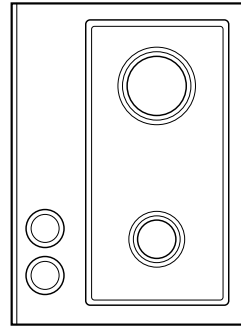

Grate

Electric grill with downdraft vent

The downdraft vent component has an integral variable-speed blower control.

Part Number:

ZEW166—240 volts

ZEW176—downdraft vent only

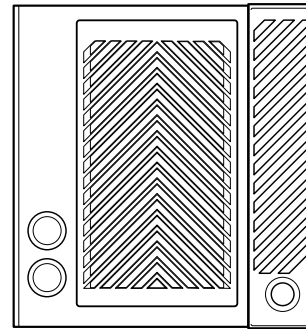

Electric updraft grill

With this component, you can charbroil meat indoors all year long. Fat drains away and collects in a jar attached below the grease well. The element is divided so the front and back sections can be controlled separately.

Part Number:

ZEW155—240 volts

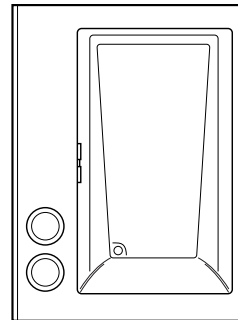

Grease well

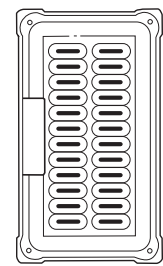

Drip pan

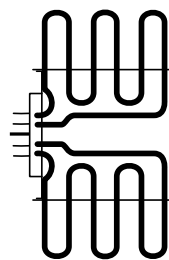

Grill element

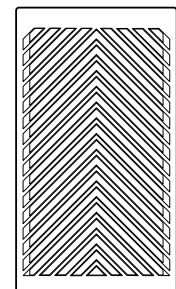

Grill grate



Grease collector jar

Halogen surface unit

The controls selected for the halogen/radiant component will give you a full range of heat settings for cooking.

The control knobs must be pushed down to turn from the off (0) position. When the control knobs are in any position other than off (0), they may be turned without pushing down.

You may notice that the knob that operates the halogen surface unit is slightly harder to turn than the knob for the radiant surface unit. This is due to the difference in design between the two controls.

NOTE:

- The lowest three settings will produce no visible evidence of the surface unit being on although up to 11% of the total wattage is being generated. On the lowest settings, the percentage of power may not cause the hot surface lights to light. An indicator light near the control knobs will glow when either surface unit is on.
- The burner “on” light will glow for all positions except the off position.

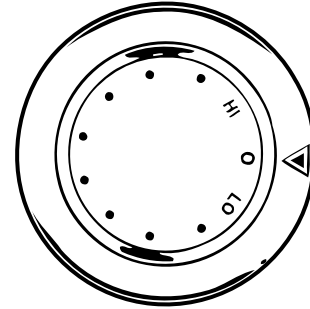

The eleven position halogen control produces the following variation in cooking power.

Switch Settings	Position	Brightness of Lamp	Typical Heater Power (%)
HI	10	Full	100
	9	High	76
	8	High	56
	7	Medium	41
	6	Medium	30
	5	Low	23
	4	Low	16
	3	Invisible	11
	2	Invisible	8
	1	Invisible	5
LO	0	OFF	0

If the halogen/radiant component is connected to 208 volts, you will notice some increase in cooking times.

Radiant surface unit

The control for the radiant surface unit is an infinite switch that can be set anywhere between LO and HI for an unlimited number of heat settings. With the infinite switch the coil cycles on and off to maintain your selected control setting.

The control knobs must be pushed down to turn from the off (0) position. When the control knobs are in any position other than off (0), they may be turned without pushing down.

Be sure you turn the control knob off (0) when you finish cooking. You will feel a “click” at the off position.

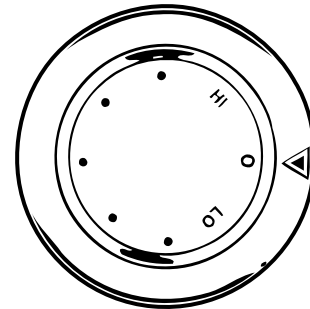

General information about halogen/radiant surface units

The halogen/radiant cooktop features heating units beneath a smooth glass ceramic surface. The surface units are shown by outlines on the glass.

Before you use the cooktop for the first time, clean it with Cooktop Cleaning Cream. This helps protect the top and makes clean-up easier.

NOTE: A slight odor is normal when a new cooktop is used for the first time. It is caused by the heating of new parts and insulating materials and will disappear in a short time.

When a surface unit is turned on, coils beneath the surface unit radiate heat through the glass to the cookware. The red glow of the coils will be visible through the glass. It will take the surface unit a few moments to heat up. The coil cycles on and off to maintain your selected control setting. With poor cookware, you will see frequent cycling of the unit off and on. Good, flat cookware will minimize the cycling.

Use only flat-bottomed cookware. Do not let pots boil dry. Overheated metal can bond to glass cooktop. An overheated copper pot will leave a residue that will permanently stain the glass.

Sliding aluminum cookware across the glass may leave metal marks. These metal marks will appear as small scratches. They can be removed with Cooktop Cleaning Cream and a razor scraper.

It is safe to place hot cookware from the oven or surface on the glass ceramic surface when the surface is cool.

Avoid sliding pans on the glass cooktop. Pan edges that are even slightly rough or grit on the cooktop can cause scratches on the glass.

Even after the surface units are turned off, the glass ceramic cooktop retains enough heat to continue cooking. To avoid overcooking, remove pans from the surface units when the food is cooked. Avoid placing anything on the surface unit until it has cooled completely.

Differences between halogen and radiant surface units

Some cooktops have both radiant and halogen surface units. This is how they differ.

- Halogen units are much brighter than the radiant units. Radiant units have a dull red glow.
- Halogen and radiant units cycle on and off frequently. This is normal. You will notice the cycling more on the halogen units because of their brightness.
- Radiant coils take about 10 seconds longer to glow than halogen units.

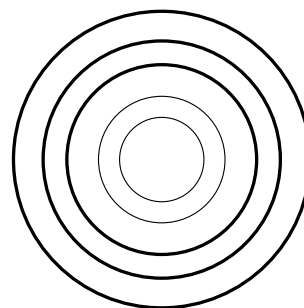

Halogen units have radiant coils in the center that do not glow as brightly as the outer halogen coils.

Types of cookware

The following information will help you choose cookware which will give good performance.

Stainless Steel: *recommended*

Especially good with a sandwich clad bottom. The sandwich bottom combines the benefits of stainless steel (appearance, durability and stability) with the advantages of aluminum or copper (heat conduction, even heat distribution).

Aluminum: *heavy weight recommended*

Good conductivity. Aluminum residues sometimes appear as scratches on the surface units, but can be removed if cleaned immediately. Because of its low melting point, thin weight aluminum should not be used.

Copper Bottom: *recommended*

Good performance, but copper may leave residues which can appear as scratches. The residues can be removed, as long as the surface units are cleaned immediately.

However, do not let these pots boil dry. Overheated metal can bond to the glass surface units. An overheated copper bottom pot will leave a residue that will permanently stain the surface units if not removed immediately.

Porcelain Enamel Covered Cast Iron:

recommended

Good conductivity. As long as the cookware is covered completely with porcelain enamel, this cookware is recommended. Cast iron retains heat, maximizing energy efficiency, and provides smooth, even heat distribution. Caution is recommended for cast iron cookware that is not completely covered with smooth porcelain enamel, as it may scratch the glass surface units.

Glass-ceramic: *usable, but not recommended*

Poor performance. May scratch the surface units.

Stoneware: *usable, but not recommended*

Poor performance. May scratch the surface units.

How to check pan performance

Use of correct cookware can affect the cooking performance and cleaning of your cooktop.

The correct cookware reduces the temperature of the cooktop surface and minimizes the chance of spillovers burning onto the cooktop.

You must use pans with perfectly flat bottoms.

Some pans may have curved or rounded bottoms or may be warped. If you are unsure of the flatness of your pans you may do this quick test.

Turn your pan upside down on the countertop, place a ruler flat against the pan surface. The bottom of the pan and the straight edge of the ruler should fit flush against each other all the way across. Turn the ruler a full 360 degrees, checking for any space between the ruler and the bottom of the pan.

Another simple test to determine even heat distribution across the cookware bottom is to put one inch of water in the pan. Bring the water to a boil and observe the location of bubbles as the water starts to boil. Good flat cookware will have an even distribution of bubbles over the bottom surface area of the pan. Bubbles localized in only a portion of the bottom indicate uneven contact of the pan to the surface unit, uneven heat transfer or an unsuitable pan.

Use pans that match the diameter of the surface unit. Cooking performance will not be as good if the cookware is either smaller or larger than the surface unit.



Pans with rounded, curved, ridged or warped bottoms are not recommended.

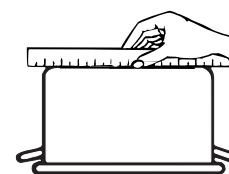

Check pans for flat bottoms by using a straight edge.

For best results

- Place only dry pans on the surface units. Do not place lids on the surface units, particularly wet lids.
- Do not use woks that have support rings. This type of wok will not heat on the glass surface units.
- We recommend that you use only a flat-bottomed wok. They are available at your local retail store. The bottom of the wok should have the same diameter as the surface unit to insure proper contact.
- Some special cooking procedures require specific cookware such as pressure cookers, deep fat fryers, etc. All cookware must have flat bottoms and be the correct size.

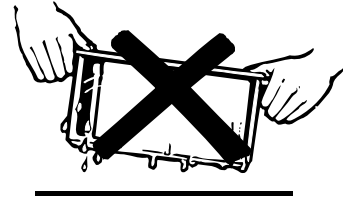

Do not place wet pans on the glass surface units.

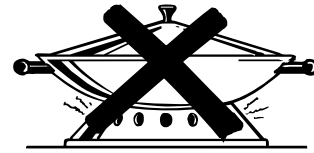

Do not use woks with support rings on the glass surface units.



Use flat-bottomed woks on the glass surface units.

Special cautions for glass surface units



• Don't store heavy items above the cooktop. If they drop onto the surface units, they can cause damage.

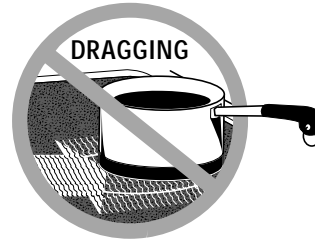

• Do not slide cookware across the surface units because it can scratch the glass—the glass is **scratch resistant, not scratch proof.**



• Always place the pan in the center of the surface unit you are cooking on.



• Never cook directly on the glass. Always use cookware.

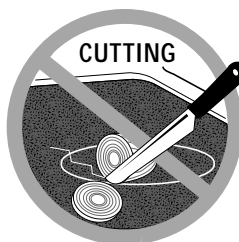

• Do not use the surface as a cutting board.

Observe the following points in canning

Note: Flat-bottomed canners are required for glass surface units.



NOTE: Canning cannot be done on the grill component.

Safe canning requires that harmful microorganisms are destroyed and that the jars are sealed completely. When canning foods in a water-bath canner, a gentle but steady boil must be maintained for the required time. When canning foods in a pressure canner, the pressure must be maintained for the required time.

After you have adjusted the controls, it is very important to make sure the prescribed boil or pressure levels are maintained for the required time.

Since you must make sure to process the canning jars for the prescribed time, with no interruption in processing time, do not can on any cooktop surface unit if your canner is not flat.

- 1 Be sure the canner fits over the center of the surface unit. If your cooktop or its location does not allow the canner to be centered on the surface unit, use smaller diameter pots for good canning results.
- 2 When using the glass cooktop component, flat-bottomed canners must be used. Do not use canners with flanged or rippled bottoms (often found in enamelware) because they don't make enough contact with the surface units and take a long time to boil water.

Pots that extend beyond 1 inch of the surface unit's circle are not recommended for most surface cooking.

When canning with water-bath or pressure canner, larger-diameter pots may be used. This is because boiling water temperatures (even under pressure) are not harmful to the cooktop surfaces surrounding the surface units.

HOWEVER, DO NOT USE LARGE DIAMETER CANNERS OR OTHER LARGE DIAMETER POTS FOR FRYING OR BOILING FOODS OTHER THAN WATER. Most syrup or sauce mixtures—and all types of frying—cook at temperatures much higher than boiling water. Such temperatures could eventually harm the glass cooktop surfaces.

- 3 When canning, use recipes and procedures from reputable sources. Reliable recipes and procedures are available from the manufacturer of your canner; manufacturers of glass jars for canning, such as Ball and Kerr; and the United States Department of Agriculture Extension Service.
- 4 Remember that canning is a process that generates large amounts of steam. To avoid burns from steam or heat, be careful when canning.

NOTE: If your house has low voltage, canning may take longer than expected, even though directions have been carefully followed. The process time will be shortened by:

- (1) using a pressure canner, and
- (2) starting with HOT tap water for fastest heating of large quantities of water.

What is a temperature limiter?

Every halogen and radiant surface unit has a Temperature Limiter. The Temperature Limiter protects the glass-ceramic surface from getting too hot.

If the bottom of your canner is not flat, the surface unit can overheat, triggering the temperature limiters to turn the unit off for a time. This will stop the boil or reduce the pressure in the canner.

The Temperature Limiter may turn off the elements if:

- The pan boils dry.
- The pan bottom is not flat.
- The pan is off center.
- There is no pan on the unit.

Gas Burner Component

Component Cooktop System

Before using your gas burners

The ZGW124 and ZGW125 gas cooktops are not convertible to LP gas. They are designed to operate on natural gas only.

This component has one large 10,500-BTU burner and one smaller 6,000-BTU burner.

When a downdraft vent is used next to a gas component, food will cook faster if you use a low vent setting and keep the pan covered (if recipe allows).

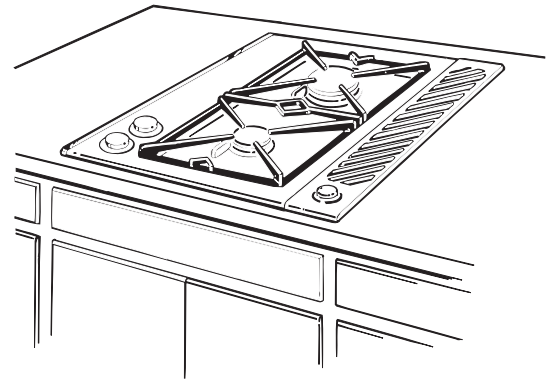

Automatic ignition

Both burners on this gas cooktop component are lighted by electric ignition that eliminates the need for standing pilot lights.

All the igniters make sparking sounds and spark even when only a single burner is being turned on. Do not touch any of the burners when the igniters are sparking.

Auto relight

The burners on this gas cooktop automatically relight if the flame goes out. This helps prevent the inconvenience of manually having to relight a burner. As with automatic ignition, all of the burner igniters spark while a burner is relighting. Do not touch any of the burners when the igniters are sparking.

The burners will relight at any setting. However, for the burners to light quickly and consistently when the gas is turned on, the knobs should be turned to the LITE position until ignition occurs.

Power outage

In case of a power outage, you can light the surface burners on your cooktop with a match. Holding a lighted match to the burner, turn the knob to the LO position.

If the knob setting is toward HI, the flame flare-up could burn your hand. **Use extreme caution when lighting burners manually.** Cookware should not be in place over the burner when lighting a burner this way.

Surface burners in use when an electrical power failure occurs will continue to operate normally.

To light a burner

1. The gas burner controls must turn counterclockwise to the LITE position to ignite the burner. The burner ignites automatically.
 2. Once the burner is ignited, turn the control knob counterclockwise to adjust the flame lower. A sparking sound caused by the igniter is normal until ignition occurs.
 3. The burners will relight at any setting. However, for the burners to light quickly and consistently when the gas is turned on, the knobs should be turned to the LITE position until ignition occurs.
 4. To turn a burner off, turn the knob clockwise as far as it will go, to the off (O) position.
- The front burner is best for smaller pans and cooking operations requiring carefully controlled simmering conditions. The rear burner is the high power burner for larger pans and fast boiling operations.
 - Do not operate a burner for an extended period of time without cookware on the grate. The finish on the grate may chip without cookware to absorb the heat.
 - Check to be sure the burner you turned on is the one you want to use.
 - Be sure the burners and grates are cool before you place your hand, a pot holder, cleaning cloths or other materials on them.

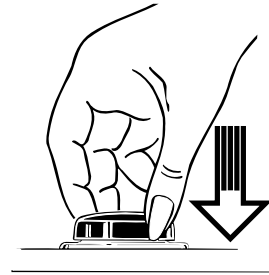

Push the control knob in and turn it counterclockwise to the desired position.

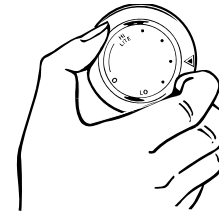

Turn the knob either direction to adjust the flame size.

How to select flame size

Watch the flame, not the knob, as you reduce heat.

The flame size on a gas burner should match the cookware you are using.

FOR SAFE HANDLING OF COOKWARE, NEVER LET THE FLAME EXTEND UP THE SIDES OF THE COOKWARE.

Any flame larger than the bottom of the cookware is wasted heat and only serves to heat the handle.

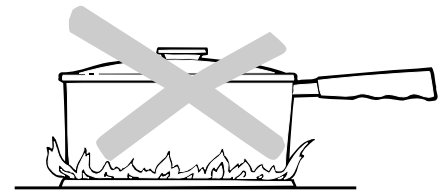

Cookware

Aluminum: Medium-weight cookware is recommended because it heats quickly and evenly. Most foods brown evenly in an aluminum skillet. Use saucepans with tight-fitting lids for cooking with minimum amounts of water.

Cast Iron: If heated slowly, most skillets will give satisfactory results.

Enamelware: Under some conditions, the enamel of some cookware may melt. Follow cookware manufacturer's recommendations for cooking methods.

Glass: There are 2 types of glass cookware—those for oven use only and those for surface cooking (saucepans, coffee and teapots). Glass conducts heat very slowly.

Heatproof Glass Ceramic: Can be used for either surface or oven cooking. It conducts heat very slowly and cools very slowly. Check cookware manufacturer's directions to be sure it can be used on gas cooktops.

Stainless Steel: This metal alone has poor heating properties, and is usually combined with copper, aluminum or other metals for improved heat distribution. Combination metal skillets generally work satisfactorily if they are used at medium heat as the manufacturer recommends.

Wok cooking

We recommend that you use only a flat-bottomed wok. They are available at your local retail store.

Do not use woks that have support rings.

Use of these types of woks, with or without the ring in place, can be dangerous. Placing the ring over the burner grate may cause the burner to work improperly resulting in carbon monoxide levels above allowable current standards. This could be dangerous to your health. Do not try to use such woks without the ring. You could be seriously burned if the wok tipped over.



Use only flat-bottomed woks.

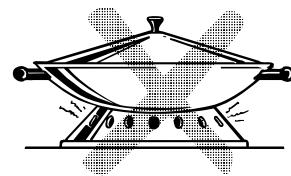

Do not use woks with support rings.

Stove top grills

Do not use stove top grills on your sealed gas burners. If you use the stove top grill on the sealed gas burner it will cause incomplete combustion and can result in exposure to carbon monoxide levels above allowable current standards. This can be hazardous to your health.

Grill Component

Component Cooktop System

Before using your grill

NOTE: The grill grate must be preconditioned before using it for the first time. To precondition, first wash it in soap and water. Dry with a soft cloth. Then use a paper towel to apply a small amount of no-stick cooking spray to the grate. Remove excess with a clean paper towel.

Use the grill for preparing meals with the appearance and flavor of commercially char-broiled meats. The grill must be very hot for this type of cooking and smoke and spatter is to be expected.

Be sure to use your venting system when grilling to help minimize smoke.

You should have either a component downdraft vent installed into the cooktop system or a high-capacity vent hood.

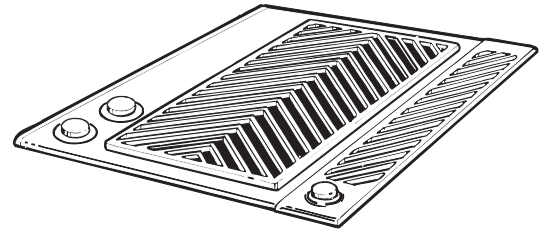

Grill control

Most cooking on the grill is done at the HI setting. Each half of the grill component is controlled separately.

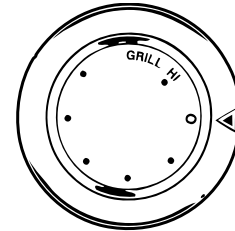

How to assemble the grill module

1. Be sure both the controls for the grill are off (O).
2. Place the drip pan in the grease well first as shown in the illustration in this section.
3. Grasp the grill element with both hands near the plug. Keeping the element as nearly horizontal as possible, push the plug firmly into the electrical receptacles, to insure complete contact. The element should lie flat and rest on the ridges of the drip pan.
4. Place the grill grate into the opening in the cooktop over the grill element.
5. Be certain the grease jar is clean and firmly secured in the tube and lid assembly under the porcelain enamel grease well.

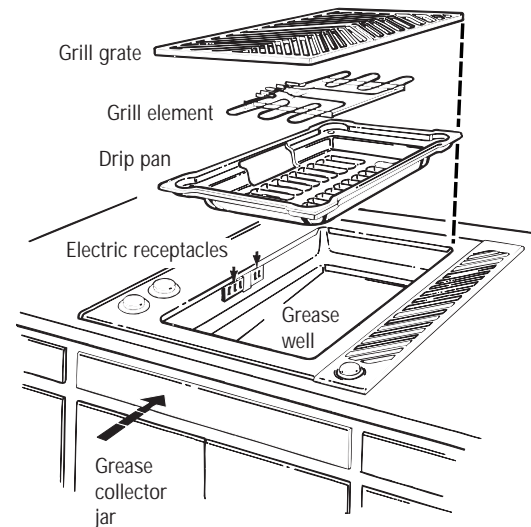

Grill tips

- The grill must be preheated to get the grill components hot enough to sear the meat and seal in the juices. Preheat the grill for 10 minutes at HI heat setting, then turn to the desired setting for cooking.
- The grill element is divided so the front and rear sections are controlled separately.
- You can heat both sections to the same temperature for cooking large amounts of the same food, or you can vary the temperatures on front and rear for cooking two different foods. Also, you can save energy when cooking small amounts of food by turning only one section on and leaving the other off entirely.
- Do not leave grill unattended while it is in use.
- Remove accumulated grease from the non-removable grease well after each use to lessen smoking and odors. Be sure opening to grease tube is clean. Grease buildup can become a fire hazard.
- Make sure the removable grease collector jar and drip pan are clean and in place before using the grill.
- Remove grease from the grease collector jar after each use to avoid spillovers.
- The grates should be oiled or sprayed with a non-stick coating before cooking to prevent sticking. Remove the grate before spraying and spray only while cool. Spraying directly onto a hot grill may cause a fire.
- Trim the fat from meat before placing on the grill. This will reduce smoking and lessen grease buildup in the drip pan, grease well and grease jar.
- Allow space between foods when placing them on the grill. Air and heat need to circulate around the food for best cooking results.
- Occasionally rearrange foods on the grill to prevent sticking and provide better browning.

What to do if a flame-up occurs

To control flame-ups, set heat setting at LO, rather than off (O). If you have a bad flame-up and there is danger of the fire spreading, take the following steps immediately:

1. Turn the grill controls to off (O), and turn the downdraft vent control to HI.

If you are using an overhead updraft vent hood, turn it off until the flame-up stops.

2. Use a long-handled utensil to remove the food from the grill. *Be careful not to get burned.*

The fire should start to go out. If it does not, smother the flames by covering the entire grill with a large cookie sheet or the lid from a large roasting pan.

▲ CAUTION!

- NEVER USE WATER ON A GREASE FIRE. Water will spread the flames.
- Never line the grill grate or the porcelain enamel grease well with aluminum foil. Doing so may block drainage of grease, causing excessive smoking, fire or component damage.
- It is recommended that you have a dry chemical, foam or Halon type fire extinguisher where you can easily reach it in case of a cooking fire.
- Never try to use charcoal or flavored wood chips in the well under the grill grate. Use of charcoal indoors without proper ventilation produces carbon monoxide that can be fatal. Also, burning charcoal in the well will permanently damage the porcelain coating in the well.
- NEVER LEAVE THE KITCHEN while grilling meats or other juicy foods. Fats and juices drip on the hot grill element and may cause flame-ups. When grilling, you should always be present to control flame-ups so they do not get out of hand.

Questions and answers

- Q. When cooking many individual foods, what can I do to insure that foods will cook evenly?**
- A.** When cooking foods of various sizes and thicknesses, start larger or thicker pieces first and add quicker-cooking smaller pieces later. Press meat lightly to lie flat on grill. Slash the fat on edges of steaks and chops to prevent curling. Break the joints of split chickens so they will lie flat.
- Q. My grilled meats sometimes come out drier than they should. What can I do to help prevent this?**
- A.** Season meats after cooking rather than before—salt can draw out juices and dry out meat. Use tongs to turn and rearrange meats on the grill; forks will pierce the meat and release juices.
- Q. I follow the cooking times suggested, but my foods don't get done properly. Is there something wrong with my grill?**
- A.** Probably not. Suggested cooking times should be used only as a general guide. Variables in food can change the cooking times required.
- Q. How can I keep barbecued meats from developing an unattractive burned look and taste?**
- A.** Sauces containing sugar will often burn if used during the entire cooking time. If your favorite sauce contains sugar, try adding it only during the last 15 to 20 minutes of cooking time for best results.
- Q. Foods cooked on my grill are not browning as much as I would like. What could cause this?**
- A.** A longer preheating and grill time may be necessary to achieve the desired results.

Grill cooking guide

- Do not leave the cooktop unattended during “preheat” (knobs turned to “HI”) or any time the knobs are turned to “HI” with food on the grill. Most foods will be grilled on the HI setting.
- Preheat at the HI setting for 10 minutes before grilling. Change the heat setting as advised in your cookbook for the food you are grilling.
- Trim the excess fat from the meat.
- Before cooking steaks, slash the fat around the edges to prevent curling of the meat.
- Suggested cooking times should be used only as a guide, since variables in food can change the cooking times.
- Foods should be turned over and rearranged as needed.

Food	Total Cooking Time in Minutes	Comments
Beef Cubes (1 in.)	17–20	Marinate less-tender beef before grilling.
Beef Steaks, tender (3/4 to 1 1/4 in.)		
Rare	10–14	Turn over and rearrange as needed to achieve desired doneness.
Medium	12–16	
Well (1 1/2 to 2 in.)	16–20	
Beef Steaks, less-tender (3/4 to 1 in.)		
Medium	18–22	Tenderize before grilling. Turn and cover with foil after first half of cooking time for more juiciness.
Well	26–30	
	42–46	
Chicken Pieces or Quarters	50–70	Turn over frequently and, if desired, baste with sauce last 10–15 minutes.
Chicken, halves	60–85	Place skin-side-down. Turn over every 15 minutes and baste frequently.
Cornish Hens, halves	40–50	Place skin-side-down. Turn over every 10 minutes and baste frequently.
Fish Steaks (1 in. or less)	15–20	Brush with melted butter.
Fish, whole (6 to 8 oz.)	17–20	If stuffed, add 6 minutes to total cooking time. Cover top with foil.
Hamburgers (3/4 in.)		
Rare	12–16	Turn over and rearrange as needed to achieve desired doneness.
Medium	16–20	
Well	22–24	
Ham Steaks (1 to 1 1/2 in.) precooked	16–20	
Hot Dogs	8–9	Turn frequently.
Kabobs Meat	20–25	For less-tender vegetables, reduce time 4 to 6 minutes.
Vegetable	10–15	
Lamb Chops (3/4 to 1 in.)	26–30	
Loyster Tails	15–20	Cut thin undershell to expose meat. Turn over every 5 to 10 minutes. Brush with butter.
Pork Chops, loin or rib (1/2 in.)	18–20	
(1 in.)	30–36	
Sausage Links (4 oz. each)		
Raw	22–24	Grill whole or cut into 2 to 4 pieces. Turn to brown all sides.
Precooked	12–16	
Spareribs Entree (3 lbs.)	60–80	Parboil 5 minutes before grilling. Rearrange and turn over frequently. Baste with sauce last 10 minutes, if desired.
Appetizer (2 lbs.)	50–60	
Vegetable Halves	25–30	Choose tender vegetables such as squash and tomatoes. Cover with foil. For tomatoes, reduce cooking time 10 minutes.

Using the vent system

The built-in vent system helps remove cooking vapors, odors and smoke from foods prepared on the cooktop components.

To operate the vent system manually, turn the knob on the control panel clockwise to the desired blower speed.

Use the control knob at the front of the vent grille to adjust the blower speed. A HI setting is recommended when flame-ups occur while cooking on the grill.

The downdraft blower adjacent to the grill comes on automatically when the grill is turned on. It turns off automatically when the grill is turned off (O).

The blower speed, while grilling, will always be the high speed. No adjustment is possible while the grill is operating. The blower can be used independent of the grill and then speed adjustment is possible.

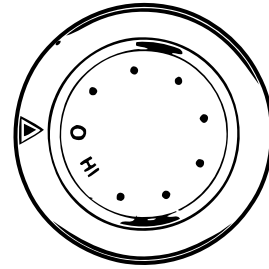

Care and Cleaning

Component Cooktop System

Proper care and cleaning are important so your Component Cooktop System will give you efficient and satisfactory service. Follow these directions carefully to help assure safe and proper maintenance.

BE SURE ELECTRICAL POWER IS OFF BEFORE CLEANING ANY COMPONENTS.

Care of the components

Some of the components must be cured or preconditioned before using them for the first time.

Components and accessories should be cleaned after each use. The longer a soil remains, the harder it is to clean. See each component's section in this guide for specific instructions.

Brushed stainless steel finish

Wash with soap and water. For heavy soils, first cover with a damp cloth and let soak 30 minutes. A stainless steel cleaner may be used.

To remove fingerprints, apply a little baby oil or cooking oil with a cloth or paper towel. Rub in the same direction as the brush marks in the stainless steel finish.

Stubborn baked-on food residue or stains on the stainless steel surfaces can be removed by using pad-type oven cleaners. For your safety, use extreme caution. Oven cleaners are caustic and can damage or discolor most other surfaces.

Do not use spray-type oven cleaners. Overspray will damage nearby surfaces. Use newspaper and masking tape to cover surfaces such as back wall, control panel, range sides, countertop, etc. Remove grates, grill element or porcelain enamel drip pan.

Control panel and knobs

Clean up any spills or spatters with a damp cloth. Remove heavier soil with warm, soapy water.

Clean the control panel with mild liquid dish detergent and a soft cloth. Rub the control panel lightly.

CAUTION: Do not use abrasives of any kind on the control panel.

The control knobs may be removed for easier cleaning.

To remove a knob, pull it straight off the stem. Wash the knobs in soap and water but do not soak.

Do not allow water to run down inside the surface of the panel while cleaning. After drying, return the knobs to the cooktop, making sure to match the flat area on the knob to the shaft.

General information for glass surface units

Before you use the cooktop for the first time, clean the glass surface units with cleaning cream. This helps protect them top and makes clean-up easier.

Proper care and cleaning are important so your cooktop will give you efficient and satisfactory service.

If soil, mineral deposits from evaporated water spills or metal rub-off from aluminum cookware is not removed, it will burn on the glass surface units and cause permanent discoloration.

Follow the directions in this section carefully in caring for the glass surface units to assure safe and proper maintenance.

Daily cleaning of the glass surface units

Use only a recommended cleaning cream, such as Cerama Brite or Cooktop Cleaning Cream, on the glass surface units.

Normal, light soil on the glass surface units

- 1 Rub a few drops (less is better) of the cleaning cream onto soiled area using a damp paper towel. Buff with a dry paper towel until all soil and cream are removed. Frequent cleaning leaves a protective coating which is essential in preventing scratches and abrasions.
 - 2 Clean the surface units with the cleaning cream after each use.
-

Heavy, burned-on soil on the glass surface units

- 1 Apply a few drops of the cleaning cream to the (cool) soiled area.
 - 2 Using a damp paper towel, rub the cream into the burned-on area. As with any burned-on spill, this may require some effort.
 - 3 Carefully scrape soil with razor scraper. Hold scraper at a 30° angle against the glass surface units.
 - 4 If any soil remains, repeat the steps listed above. For additional protection, after all soil has been removed, polish the entire surface unit with the cleaning cream.
 - 5 Buff with a dry paper towel.
- NOTE:**
- Be sure to use a new, sharp razor scraper. Do not use a dull or nicked blade.
 - **Store the razor scraper out of reach of children.**

*Special care
of the glass
surface
units*

Sugary spillovers (such as jellies, fudge, candy syrups) or **melted plastics** can cause pitting of the surface units of your cooktop (not covered by the warranty) unless the spill is removed while still hot. **Special care should be taken when removing hot substances.** Follow these instructions carefully and remove soil while spill is still hot.

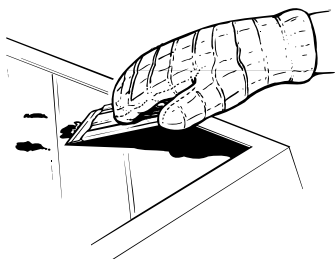

Note: Using a razor scraper will not damage the glass surface units if the 30° angle is maintained.

- 1 Turn off all surface units affected by the spillover. Remove hot pans.
- 2 Wearing an oven mitt, hold the razor scraper at a 30° angle to the cooktop and scrape hot spill to a cool area outside the surface unit.
- 3 With the spill in a cool area, use a dry paper towel to remove any excess. Any spillover remaining should be left until the surface of the cooktop has cooled.

Do not continue to use the soiled surface unit until all of the spillover has been removed. Follow the steps under Heavy Soil to continue the cleaning process.

*Precautions
for the glass
surface
units*

- If pots with a thin overlay of aluminum, copper or enamel are allowed to boil dry, the overlay may bond with the glass surface units and leave a black discoloration. This should be removed immediately before heating again or the discoloration may be permanent.
- Water stains (mineral deposits) are removable using the cleaning cream or full strength white vinegar.
- Use of window cleaner may leave an iridescent film on the glass surface units. The cleaning cream will remove this discoloration.
- If you slide **aluminum or copper cookware** across the glass surface units of your cooktop, they may leave **metal markings which appear as scratches**. If this should happen, use the razor scraper and cleaning cream to remove these markings. Failure to remove these residues immediately may leave permanent marks.
- Most cleaners contain ammonia, chemicals and abrasives which can damage the surface units. **Use only the recommended cleaning cream for proper cleaning and protection of your glass surface units.**
- **Read and follow all instructions and warnings on the cleaning cream labels.**

*Future care
of the glass
surface
units*

- Do not use dishwashing detergents. They will remove the protective coating and therefore make the surface units more susceptible to staining.

To conveniently order more cream and/or scrapers for cleaning your glass surface units, please call our toll free number:

National Parts Center	800-626-2002
Cleaner	# WX10X300
Scraper	# WX5X1614
Cream and scraper kit	# WB64X5027

Gas burner assembly

The burner assemblies should be washed regularly and after spillovers.

Turn all control knobs to the off (O) position before removing burner parts. Allow parts to cool before removing.

CAUTION: DO NOT OPERATE THE BURNER WITHOUT ALL BURNER PARTS CORRECTLY IN PLACE. The electrode of the spark igniter is exposed when the burner cap is removed. Contact with an exposed igniter while a burner is being turned on will cause a slight electrical shock.

The burner grate, burner caps and burner support rings can be lifted off, making them easy to clean. (The drip pan cannot be removed.) Wash burner parts with an all-purpose, non-abrasive cleaner and warm water. Soak stubborn soil. Dry the burner assemblies with a cloth—don't reassemble them wet.

To reassemble: Place the burner support ring onto the burner bowl first. Before replacing the burner cap, first examine the four notches on its underside. One of the notches, shaped differently from the other three, includes an indexing key for the spark igniter—this notch fits over the spark igniter. When replacing the burner grate, make sure the bottom of the burner grate fits securely into a corresponding ridge in the drip pan.

Burner grates can be cleaned by hand or in a self-cleaning oven. Although the burner grate is durable, it will gradually lose its shine, regardless of the care you take of it. This is due to its exposure to the high temperature of the gas flames.

To preserve the porcelain enamel finish as long as possible, have a pan on the grate before you turn on the burner, and lower the flame when food reaches the desired cooking temperature.

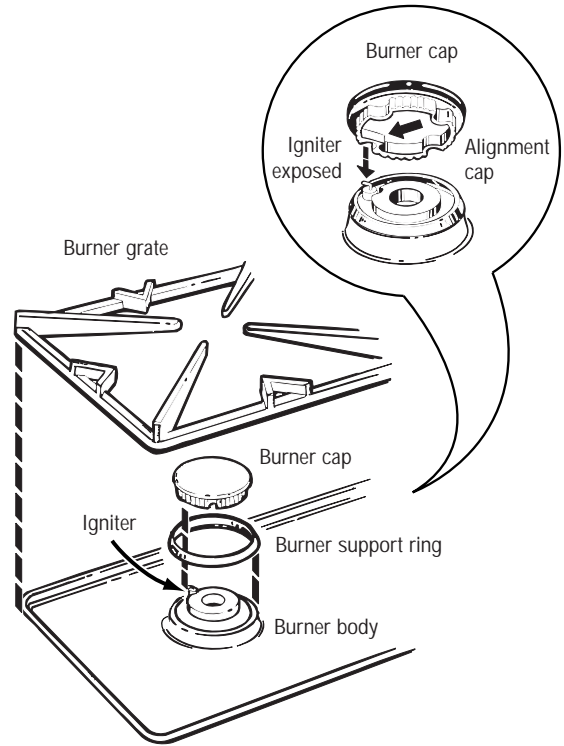

CAUTION: DO NOT OPERATE THE BURNER WITHOUT ALL BURNER PARTS CORRECTLY IN PLACE.

Grill component

Clean the grill component after every use. Do not put the element into water. It cleans itself when heated during normal use. To remove any charred soil, clean with a dry, stiff brush when the element is cool.

Never use steel wool or metal scouring pads because they may damage the outer casing of the element.

Wash the grill grate in the sink in soap and water. The grate may be soaked in a solution of dishwasher detergent and hot water. Use a non-metal scouring pad if necessary. **Do not use abrasive cleaning products.** The grill grate can also be cleaned in a self-cleaning oven.

From time to time, you should recondition the grate with no-stick cooking spray. See the Grill Component section.

Wash the porcelain enamel drip pan in the sink with soap and water, or put it in the dishwasher. Soak stubborn stains, then rub gently with a scouring pad.

Do not put the drip pan in the oven during a self-cleaning cycle. Doing so will cause discoloration and damage the finish.

Porcelain enamel grease well

Porcelain enamel can crack or chip with misuse. It can stain if spillovers of foods with a high acid content (such as tomatoes or lemon juice) are not cleaned up quickly.

When cleaning a porcelain enamel grease well, **be careful not to get the electrical receptacles wet. Do not try to fill the well with water when cleaning. Be sure the drain hole and tube in the grease well are not clogged.**

Grease jars

On the underside of the grill cooktop component, a grease jar is mounted to catch fat and drippings.

The lid of the jar is permanently mounted to the bottom of the cooktop component box. The lid is connected by a tube to a spout at the front of the grease well. The jar can be unscrewed from the lid to be emptied and cleaned or to be replaced. The jar is a standard 1-pint jar. Quart canning jars may also fit.

Do not use thin-walled glass or plastic jars, such as those having contained food products. Such jars could fracture.

Different foods give different amounts of fat and drippings, so you should inspect the jar each time it is used. If the jar is not emptied or replaced often enough, the fat and drippings may overflow. Be sure the drain hole and tube in the grease well are not clogged.

How to clean the vent system

The downdraft vent grille and filter should be cleaned frequently—after every use is best. Before cleaning the vent system, be sure exhaust blower is shut off.

To remove parts for cleaning:

1. Lift off the vent grille.
2. Lift the filter straight up from the filter supports.

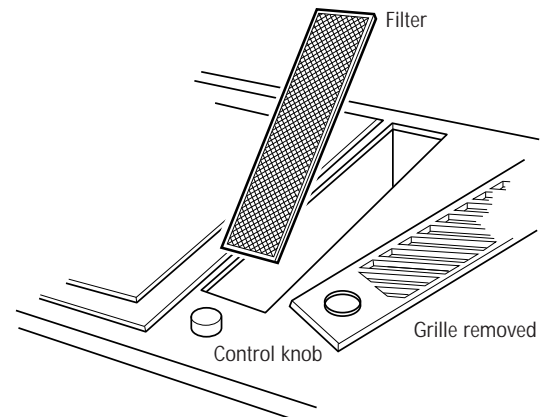

How to clean the vent grille

To clean the vent grille, remove it from the cooktop by lifting it up.

It can be cleaned by hand, in the dishwasher or in a self-cleaning oven.

How to clean the filters

To clean the filter, soak, then agitate filter in hot detergent solution prepared in the sink. Using ammonia or other alkali will darken the metal. Light brushing can be used to remove embedded dirt. Be careful not to disturb the aluminum fabric of the filter body.

Rinse, shake and remove moisture before replacing. It is advised that filters should be cleaned after every use.

Before replacing the filter into the vent system housing, inspect and wipe clean the housing walls. Do not allow grease accumulation to form.

Never operate the vent system without the filter in place. In situations where flaming might occur, the filter will retard entry of flames into the exhaust blower.

To replace the filter after cleaning, place it on the filter supports. Replace the vent grille.

Questions?

Use this
problem
solver!

PROBLEM	POSSIBLE CAUSE
COMPONENTS ARE NOT FUNCTIONING PROPERLY	<ul style="list-style-type: none"> · Difficulty may be in the main distribution panel of your house caused by a blown circuit fuse, a tripped circuit breaker, the main fuse or the main circuit breaker, depending on the nature of the power supply. If a circuit breaker is involved, reset it. If the control box uses fuses, the circuit fuse (a cartridge-type) should be changed, BUT ONLY BY SOMEONE FAMILIAR WITH ELECTRICAL CIRCUITS. If, after performing one of these procedures, the fuse blows or circuit breaker trips again, call for service. NOTE: Apartment tenants or condominium owners should request their building management perform this check before calling for service. · Controls are not properly set or wrong control is set for the component or surface unit you are using. · Grill element is not plugged in properly. · Consider the possibility of interruption in gas or electric service from the utility source.
HALOGEN/RADIANT SURFACE UNITS WILL NOT MAINTAIN A ROLLING BOIL OR FRYING RATE IS NOT FAST ENOUGH	<ul style="list-style-type: none"> · You must use pans which are absolutely flat. If light can be seen between the pan bottom and a straight edge, the halogen/radiant surface units will not transfer heat properly. · Pan bottoms should closely match the diameter of the surface unit selected.
HALOGEN/RADIANT COOKTOP FEELS HOT	<ul style="list-style-type: none"> · The halogen/radiant cooktop may seem hotter than you are used to. This is normal. · Make sure flat-bottomed pans are used. · Using the vent will help keep the halogen/radiant cooktop cooler.
FOODS COOK SLOWLY ON HALOGEN/RADIANT COOKTOP	<ul style="list-style-type: none"> · Improper cookware being used. Pan bottoms should be flat, fairly heavy weight and the same diameter as the surface unit selected.
TINY SCRATCHES (may appear as cracks) OR ABRASIONS ON HALOGEN/RADIANT COOKTOP GLASS SURFACE	<ul style="list-style-type: none"> · Incorrect cleaning methods have been used, cookware with rough bottoms have been used or coarse particles (salt or sand) were between the cookware and the surface of cooktop. Use recommended cleaning procedures, be sure cookware bottoms and cookware are clean before use and use cookware with smooth bottoms. Tiny scratches are not removable but will become less visible in time as a result of cleaning.
METAL MARKINGS (may appear as scratches on halogen/radiant cooktop glass surface)	<ul style="list-style-type: none"> · Do not slide aluminum cookware across the surface. Use the recommended cleaning procedure to remove marks. · Incorrect cleaning materials have been used, encrusted boilovers or grease spatters remain on the surface. Use a razor scraper and the recommended cleaning procedure.

The Problem Solver

Component Cooktop System

Questions?

*Use this
problem
solver!*

PROBLEM	POSSIBLE CAUSE
DARK STREAKS OR SPECKS ON HALOGEN/RADIANT COMPONENT	· Use a razor scraper and recommended cleaning procedure.
AREAS OF DISCOLORATION ON HALOGEN/RADIANT SURFACE COOKTOP	· Marks from aluminum and copper pans as well as mineral deposits from water or food can be removed with Cooktop Cleaning Cream.
FREQUENT CYCLING OFF AND ON OF HALOGEN/RADIANT SURFACE UNITS	· Incorrect cookware used. Use only flat cookware to minimize cycling.
HOT SUGAR MIXTURES/PLASTIC MELTED TO THE HALOGEN/RADIANT SURFACE	· Turn the surface unit to LO, wipe the hot cooktop with several dry paper towels. Use a razor scraper held at a 30° angle to the cooktop to scrape the hot spill to a cool area outside the surface unit. Let the cooktop cool. Clean with Cooktop Cleaning Cream.
CONTROL KNOB WILL NOT TURN	· When the knob is at the off (O) position, it must be pushed in before it can be turned. When the knob is at any other position, it can be turned without being pushed in.
SPARKING SOUND PERSISTS AFTER BURNER LIGHTS	· Sparking of the igniter is normal. Air currents in the kitchen from an open window or a person moving quickly can interrupt the flame, causing automatic relight sparking. As the burner warms, the sparking is less likely to occur. If the sparking persists for a long time, call for service.
SPARKING SOUND PERSISTS AFTER BURNER IS OFF	· Be sure the control knobs are in the off (O) position. If the sparking sound persists call for service.
BURNERS DO NOT LIGHT	<ul style="list-style-type: none"> · Make sure electrical plug is plugged into a live power outlet. · Gas supply not connected or not turned on. · Orifice in burner body may be clogged (see the Gas Burner Component section). Remove the obstruction. · Burner parts not replaced correctly (see the Gas Burner Component section). · Counter unit not properly grounded or polarized. This can affect spark ignition. · Soil clogging holes in burner cap. Remove and clean. · Cooktop burner top not replaced correctly.

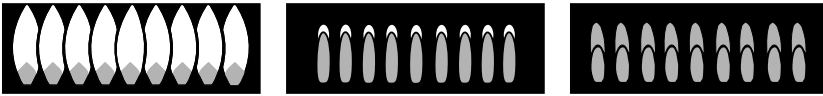
PROBLEM	POSSIBLE CAUSE
BURNERS HAVE YELLOW OR YELLOW-TIPPED FLAMES	 <p data-bbox="667 407 1485 457"> A. Yellow flames: <i>Call for service.</i> B. Yellow-tipped flames: <i>Call for service.</i> C. Soft blue flames: <i>Normal burner flames.</i> </p> <ul data-bbox="667 470 1485 527" style="list-style-type: none"> · If burner flames look like (A) or (B), call for service. Normal burner flames should look like (C), burning with a soft blue flame.
VENT SYSTEM BLOWER DOES NOT WORK	<ul data-bbox="667 548 1485 747" style="list-style-type: none"> · The circuit breaker in your house has been tripped, or a fuse has been blown. · If the components operate but the blower doesn't, the fault may be in the blower control switch or blower wiring connections. Be sure to disconnect power to the cooktop at the household distribution panel before attempting to service the blower yourself.
GRILL OR IS NOT FUNCTIONING PROPERLY	<ul data-bbox="667 768 1485 915" style="list-style-type: none"> · Grill element is not plugged in solidly. · Grill element controls are not properly set. · To use the entire surface of the grill, it is necessary to turn on both the front and the rear controls.
FOODS STICK TO GRILL	<ul data-bbox="667 936 1485 999" style="list-style-type: none"> · Grill was not pre-seasoned before first use. · Heat setting is too high.
EXCESSIVE SMOKE	<ul data-bbox="667 1020 1485 1127" style="list-style-type: none"> · Accumulated grease in the drip pan or grease well or food soil on the grate are causing excessive smoke. · Fats were not trimmed from meats prior to cooking.

If you need more help...call, toll free:
GE Answer Center®
800.626.2000
consumer information service

With the purchase of your new Monogram appliance, receive the assurance that if you ever need information or assistance from GE, we'll be there. All you have to do is call—toll-free!

GE Answer Center®

800.626.2000

Whatever your question about any Monogram major appliance, GE Answer Center® information service is available to help. Your call—and your question—will be answered promptly and courteously. And you can call any time. GE Answer Center® service is open 24 hours a day, 7 days a week.

In-Home Repair Service

800-444-1845

A GE consumer service professional will provide expert repair service, scheduled at a time that's convenient for you. Many GE Consumer Service company-operated locations offer you service today or tomorrow, or at your convenience (7:00 a.m. to 7:00 p.m. weekdays, 9:00 a.m. to 2:00 p.m. Saturdays). Our factory-trained technicians know your appliance inside and out—so most repairs can be handled in just one visit.

For Customers With Special Needs...

800.626.2000

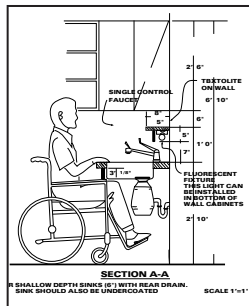

GE offers, free of charge, a brochure to assist in planning a barrier-free kitchen for persons with limited mobility.

Consumers with impaired hearing or speech who have access to a TDD or a conventional teletypewriter may call 800-TDD-GEAC (800-833-4322) to request information or service.

Service Contracts

800-626-2224

You can have the secure feeling that GE Consumer Service will still be there after your warranty expires. Purchase a GE contract while your warranty is still in effect and you'll receive a substantial discount. With a multiple-year contract, you're assured of future service at today's prices.

Parts and Accessories

800-626-2002

Individuals qualified to service their own appliances can have parts or accessories sent directly to their home. The GE parts system provides access to over 47,000 parts...and all GE Genuine Renewal Parts are fully warranted. VISA, MasterCard and Discover cards are accepted.

User maintenance instructions contained in this guide cover procedures intended to be performed by any user. Other servicing generally should be referred to qualified service personnel. Caution must be exercised, since improper servicing may cause unsafe operation.

YOUR MONOGRAM COMPONENT COOKTOP WARRANTY
Staple sales slip or cancelled check here. Proof of original purchase date is needed to obtain service under warranty.

WHAT IS COVERED

FULL ONE-YEAR WARRANTY

For one year from date of original purchase, we will provide, free of charge, parts and service labor in your home to repair or replace **any part of the cooktop** that fails because of a manufacturing defect.

FULL FIVE-YEAR WARRANTY

(on some models) For five years from the date of original purchase, we will provide, free of charge, parts and service labor in your home to repair or replace the glass cooktop due to:

- Cracking of the glass cooktop due to thermal shock
- Discoloration of the glass cooktop
- Wear off of the pattern on the glass cooktop
- Cracking of the rubber seal between the glass cooktop and the porcelain edge

- Burn out of any of the radiant or halogen surface units.

.....
This warranty is extended to the original purchaser and any succeeding owner for products purchased for ordinary home use in the 48 mainland states, Hawaii and Washington, D.C. In Alaska the warranty is the same except that it is LIMITED because you must pay to ship the product to the service shop or for the service technician's travel costs to your home.

All warranty service will be provided by our Factory Service Centers or by our authorized Customer Care® servicers during normal working hours.

Should your appliance need service, during warranty period or beyond, call 800-444-1845.

WHAT IS NOT COVERED

- Service trips to your home to teach you how to use the product.

Read your Use and Care material.

If you then have any questions about operating the product, please contact your dealer or our Consumer Affairs office at the address below, or call, toll free:

GE Answer Center®
800.626.2000

consumer information service

- Replacement of house fuses or resetting of circuit breakers.
- Failure of the product if it is used for other than its intended purpose or used commercially.
- Damage to the glass surface units caused by the use of cleaners other than the recommended cleaning cream.

- Damage to the glass surface units caused by hardened spills of sugary materials or melted plastic that are not cleaned according to the directions in the Use and Care Guide.

- Improper installation.

If you have an installation problem, contact your dealer or installer. You are responsible for providing adequate electrical, gas, exhausting and other connecting facilities as described in the Installation Instructions provided with the product.

- Damage to the product caused by accident, fire, floods or acts of God.

- Damage to the product due to misuse or abuse.

WARRANTOR IS NOT RESPONSIBLE FOR CONSEQUENTIAL DAMAGES.

Some states do not allow the exclusion or limitation of incidental or consequential damages, so the above limitation or exclusion may not apply to you. This warranty gives you specific legal rights, and you may also have other rights which vary from state to state.

To know what your legal rights are in your state, consult your local or state consumer affairs office or your state's Attorney General.

Warrantor: General Electric Company. If further help is needed concerning this warranty, write: Manager—Consumer Affairs, GE Appliances, Louisville, KY 40225

**Consumer Product
Ownership Registration**
Important Mail Today

GE Appliances



Place
1st Class
Letter
Stamp
Here

General Electric Company
Warranty Registration Department
P.O. Box 34070
Louisville, KY 40232-4070

Consumer Product Ownership Registration

Dear Customer:

Thank you for purchasing our product and thank you for placing your confidence in us. We are proud to have you as a customer!

Follow these three steps to protect your new appliance investment:

1 Complete and mail your Consumer Product Ownership Registration today. Have the peace of mind of knowing we can contact you in the unlikely event of a safety modification.

2 After completing this registration, write your model and serial numbers in this guide. You will need this information should you require service. Our service number is 800-444-1845.

3 Read your "Use and Care Guide" carefully. It will help you operate your new appliance properly. If you have questions, or need more information call the GE Answer Center® 800.626.2000.

Important: To ensure that your product is registered, fold and mail this form. No envelope is needed.

Consumer Product Ownership Registration



Product Model Serial
Component Cooktop System

Mr. Ms. Mrs. Miss

First Name _____ Last Name _____

Street Address _____

Apt. # _____

City _____ State _____ Zip Code _____

Date Placed In Use Month _____ Day _____ Year _____ Phone Number _____-_____-_____



GE Appliances

General Electric Company
Louisville, Kentucky 40225

CUT HERE



D-953-0555-000
Part No. 164D3333P077
Pub No. 49-8835

6-97 CG

Printed in the United States