

Use & Care Guide

30" Free-Standing Liquefied Gas Wave Touch™ Dual Fuel Range



 **Electrolux**

Table of contents

Finding information	2
SAFETY	3-6
Features	7-9
Getting Started	10-12
• About burner caps and heads	10
• Power up, control display modes & timers	11
• Control lock & oven lights	12
Settings for Best Results	13-14
Surface Cooking	15
Setting Surface Controls	16
• Setting cooktop controls	16
• Burner locations	16
Setting Oven Controls	18-39
• Rapid preheat	18
• Bake	19
• Using cook time	20
• Using cook time with end time	21
• Broil	22-23
• Convection bake	24
• Using convection convert	25
• Convection roast	26-27
• Probe	28-29
• Convection broil	30
• Keep warm	31
• Slow cook	32
• Perfect turkey	33
• Defrost	34
• Dehydrate	34-35
• Bread proof	35
• Saving & recalling my favorite recipes	36
• Multi stage cooking	37-38
• Setting Sabbath mode	39-40
Setting Lower Oven Controls	41-43
• Bake	42
• Keep warm	42-43
Setting Your Preferences	44-49
• Setting clock display (CLO)	44
• Setting 12 or 24 hour mode (CLO)	45
• Changing between F° or C° (F-C)	45
• Setting 12hr energy saving mode (ES)	46
• Setting audio mode (AUD)	46
• Adjusting oven temperature (UPO)	47
• Factory default reset (RST)	48
• User preferences chart	49
Self-Clean	50-51
Care & Cleaning	52-58
• Cleaning recommendations	52-53
• Cleaning cooktop and parts	54
• Oven door removal	55-57
• Changing oven lights	57-58
• Keep warm	3
Solutions to Common Problems	59-61
Warranty	63

Please read & save this guide

Thank you for choosing **Electrolux**, the new premium brand in home appliances. This *Use & Care Guide* is part of our commitment to customer satisfaction and product quality throughout the service life of your new appliance.

We view your purchase as the beginning of a relationship. To ensure our ability to continue serving you, please use this page to record important product information.

Keep a record for quick reference

Purchase date

Electrolux model number

Electrolux serial number

NOTE

Registering your product with Electrolux enhances our ability to serve you. You can register online at www.electroluxappliances.com or by dropping your Product Registration Card in the mail.

Questions?

For toll-free telephone support in the U.S. and Canada:

1-877-4ELECTROLUX (1-877-435-3287)

For online support and Internet production information visit

<http://www.electroluxappliances.com>

Important safety instructions

Recognize safety symbols, words and labels

Safety items throughout this manual are labeled with a WARNING or CAUTION based on the risk type as described below:

WARNING

This symbol alerts you to situations that may cause serious body harm, death or property damage.

CAUTION

This symbol alerts you to situations that may cause bodily injury or property damage.

WARNING

If the information in this manual is not followed exactly, a fire or explosion may result causing property damage, personal injury or death.

For your safety:

- Do not store or use gasoline or other flammable vapors and liquids in the vicinity of this or any other appliance.
- Installation and service must be performed by a qualified installer, servicer or the gas supplier.

What to do if you smell gas:

- Do not try to lite any appliance.
- Do not touch any electrical switch; do not use any phone in your building.
- Immediately call your gas supplier from a neighbor's phone. Follow the gas supplier's instructions.
- If you cannot reach your gas supplier, call the fire department.

CAUTION

Do not store items of interest to children in the cabinets above a range or on the backguard of a range. Children climbing on the range to reach items could be seriously injured.

WARNING

- All ranges can tip.
- Injury to persons could result.
- Install anti-tip device packed with range.
- See Installation Instructions.



To reduce the risk of tipping, the range must be secured by properly installed anti-tip bracket provided with the range. To check if the bracket is installed properly, visually check that rear leveling leg is inserted into and fully secured by the anti-tip



bracket by removing lower panel or storage drawer. For models with a warmer drawer, grasp the top rear edge of the range and carefully attempt to tilt it forward. Refer to the installation instructions for proper anti-tip bracket installation.

WARNING

- **Never use this appliance as a space heater to heat or warm the room.** Doing so may result in carbon monoxide poisoning.
- **Never cover any slots, holes or passages in the oven bottom or cover an entire rack with materials such as aluminum foil.** Doing so blocks air flow through the oven and may cause carbon monoxide poisoning. Aluminum foil linings may trap heat, causing a fire hazard.
- **Stepping, leaning or sitting on the doors or drawers of this range can result in serious injuries and also cause damage to the range.** Do not allow children to climb or play around the range. The weight of a child on an open door may cause the range to tip, resulting in serious burns or other injury.
- **Do not use the oven or Warmer oven/ Lower Oven(if equipped) for storage.**

Save these instructions for future reference.

Important safety instructions

Read all of the following safety instructions before using this appliance:

- **Remove all tape and packaging before using the range.** Destroy the carton and plastic bags after unpacking the range. Never allow children to play with packaging material.
- **Proper Installation — Be sure your appliance is properly installed and grounded by a qualified technician in accordance with the National Fuel Gas Code ANSI Z223- latest edition, or in Canada CAN/CGA B149.1 and CAN/GGA B149.2, and the National Electrical Code ANSI/NFPA No.70-latest edition, or in Canada CSA Standard C22.1, Canadian Electrical Code, Part 1, and local code requirements.** Install only per installation instructions provided in the literature package for this range.

Ask your dealer to recommend a qualified technician and an authorized repair service. Know how to disconnect the power to the range at the circuit breaker or fuse box in case of an emergency.

- **User servicing — Do not repair or replace any part of the appliance unless specifically recommended in the manuals.** All other servicing should be done only by a qualified technician. This may reduce the risk of personal injury and damage to the range.
- **Never modify or alter the construction of a range by removing leveling legs, panels, wire covers, anti-tip brackets/screws, or any other part of the product.**
- **Air curtain or other overhead range hoods, which operate by blowing a downward air flow on to a range, shall not be used in conjunction with gas ranges other than when the hood and range have been designed, tested and listed by an independent test laboratory for use in combination with each other.**
- **Storage in or on Appliance — Flammable materials should not be stored in an oven, warmer drawer, near surface burners or in the storage drawer.** This includes paper, plastic and cloth items, such as cookbooks, plasticware and towels, as well as flammable liquids. Do not store explosives, such as aerosol cans, on or near the range.

IMPORTANT

Do not attempt to operate the range during a power failure. If the power fails, always turn off the range. If the range is not turned off and the power resumes, the range will begin to operate again. Once the power resumes, reset the clock and oven function.

- **Do not leave children alone — Children should not be left alone or unattended in the area where appliance is in use.** They should never be allowed to sit or stand on any part of the appliance.
- **DO NOT TOUCH SURFACE BURNERS, AREAS NEAR THESE BURNERS, OVEN BURNERS OR INTERIOR SURFACES OF THE OVEN.** Both surface and oven burners may be hot even though flames are not visible. Areas near surface burners may become hot enough to cause burns. During and after use, do not touch, or let clothing or other flammable materials touch these areas until they have had sufficient time to cool. Among these areas are the cook top, surfaces facing the cook top, the oven vent openings and surfaces near these openings, oven door and window.
- **Wear proper apparel — Loose-fitting or hanging garments should never be worn while using the appliance.** Do not let clothing or other flammable materials contact hot surfaces.
- **Do not use water or flour on grease fires — Smother the fire with a pan lid, or use baking soda, a dry chemical or foam-type extinguisher.**
- **When heating fat or grease, watch it closely.** Fat or grease may catch fire if allowed to become too hot.
- **Use only dry potholders - Moist or damp potholders on hot surfaces may result in burns from steam.** Do not let potholders touch hot heating elements. Do not use a towel or other bulky cloth instead of a potholder.
- **Do not heat unopened food containers - Buildup of pressure may cause container to burst and result in injury.**

Important safety instructions

Important instructions for using your cooktop

WARNING

- **Use Proper Flame Size**—Adjust flame size so it does not extend beyond the edge of the utensil. The use of undersized utensils will expose a portion of the burner flame to direct contact and may result in ignition of clothing. Proper relationship of utensil to flame will also improve efficiency.
- **Know which knob controls each surface burner.** Place a pan of food on the burner before turning it on, and turn the burner off before removing the pan.
- **Always turn knob to the full LITE position when igniting top burners.** Visually check that burner has lit. Then adjust the flame so it does not extend beyond the edge of the utensil.
- **Utensil Handles Should Be Turned Inward and Not Extend Over Adjacent Surface Burners**—To reduce the risk of burns, ignition of flammable materials, and spillage due to unintentional contact with the utensil, the handle of the utensil should be positioned so that it is turned inward, and does not extend over adjacent surface burners.
- **Never leave surface burners unattended at high heat settings**—Boilovers cause smoking and greasy spillovers that may ignite, or a pan that has boiled dry may melt.
- **Protective Liners**—Do not use aluminum foil to line surface burner pans, or oven bottom, except as suggested in this manual. Improper installation of these liners may result in risk of electric shock, or fire.
- **Glazed cooking utensils**—Only certain types of glass, glass/ceramic, ceramic, earthenware, or other glazed utensils are suitable for cook top service without breaking due to the sudden change in temperature. Check the manufacturer's recommendations for cook top use.

Important instructions for using your oven

- **Use care when opening oven door or lower oven drawer (if equipped)**—Stand to the side of the range when opening the door of a hot oven. Let hot air or steam escape before you remove or replace food in the oven.
- **Keep Oven Vent Ducts Unobstructed.** The oven vent is located below the backguard. Touching the surfaces in this area when the oven is operating may cause severe burns. Also, do not place plastic or heat-sensitive items on or near the oven vent. These items could melt or ignite.
- **Placement of oven racks.** Always place oven racks in desired location while oven is cool. If rack must be moved while oven is hot use extreme caution. Use potholders and grasp the rack with both hands to reposition. Do not let potholders contact the hot heating elements in the oven. Remove all utensils from the rack before moving.
- **Do not use the broiler pan without its insert.** The broiler pan and its insert allow dripping fat to drain and be kept away from the high heat of the broiler.
- **Do not cover the broiler insert with aluminum foil. Exposed fat and grease could ignite.**
- Cold temperatures can damage the electronic control. When using the appliance for the first time or when the appliance has not been used for an extended period of time, be certain the unit has been in temperatures above 32°F (0°C) for at least 3 hours before turning on the power to the appliance.

Important safety instructions

Important cleaning instructions

- **Clean the range regularly to keep all parts free of grease that could catch fire.** Pay particular attention to the area underneath each surface element. Do not allow grease to accumulate.
- **Kitchen cleaners and aerosols — Always follow the manufacturer's recommended directions for use.** Be aware that excess residue from cleaners and aerosols may ignite causing damage and injury.

Self cleaning ovens

- **Clean in the self-cleaning cycle only the parts listed in this Use & Care Manual.** Before self cleaning the oven, remove the broiler pan and any utensils or foods from the oven.
- **Do not use oven cleaners** — No commercial oven cleaner or oven liner protective coating of any kind should be used in or around any part of the oven.
- **Do not clean door gasket** — The door gasket is essential for a good seal. Care should be taken not to rub, damage or move the gasket.
- The health of some birds is extremely sensitive to the fumes given off during the self-cleaning cycle of any range. Move birds to another well-ventilated room.

Important Safety Notice

The California Safe Drinking Water and Toxic Enforcement Act requires the Governor of California to publish a list of substances known to the state to cause cancer, birth defects or other reproductive

See the **INSTALLATION INSTRUCTIONS** packaged with this appliance for complete installation and grounding instructions.

IMPORTANT

This appliance is designed for use with **Liquefied Petroleum (L.P.) Gas ONLY**. Do not attempt to convert this range to Natural Gas.

Oven features & options

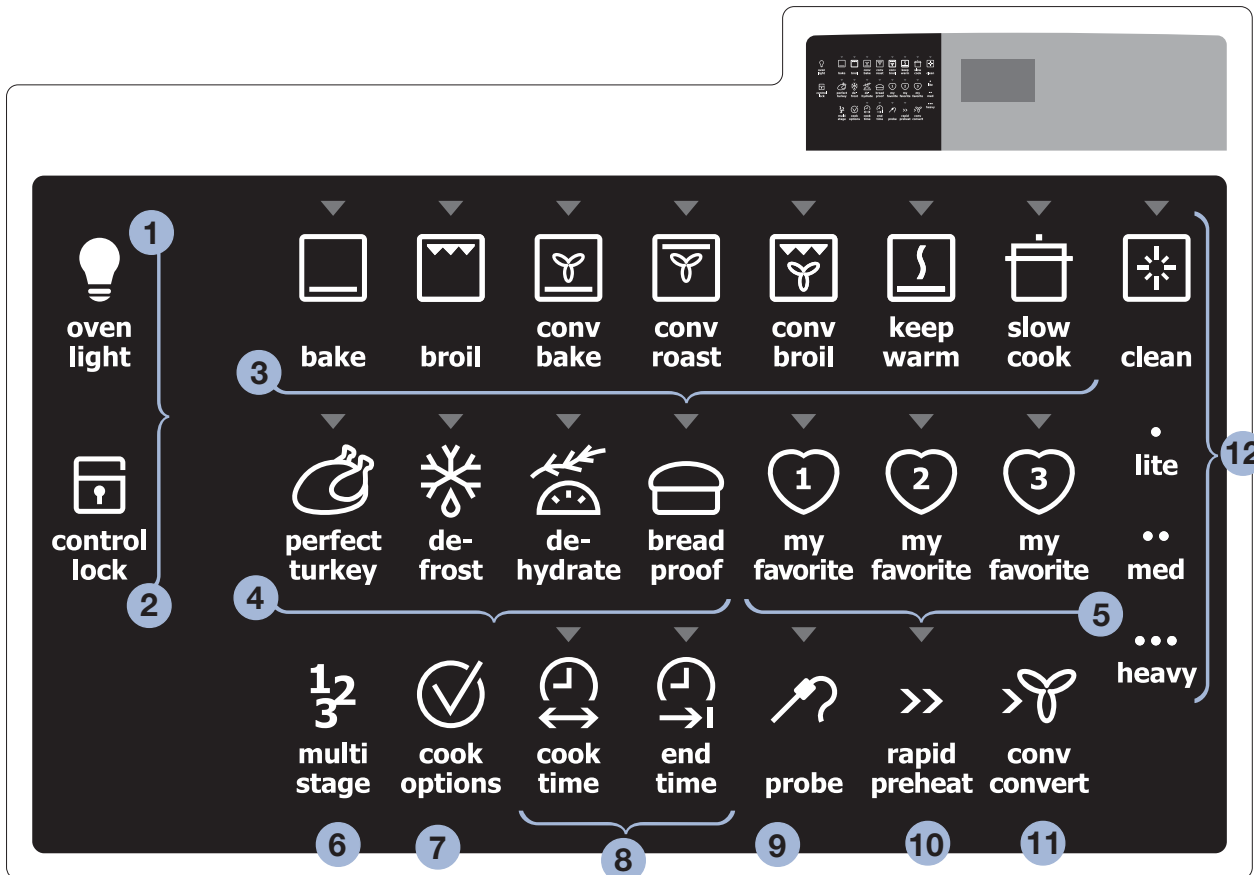

1. Luxury-Lighting™ interior oven lights -pg 12
2. Control lock -pg 12
3. Standard cooking
 - Bake -pg 19
 - Broil -pg 22-23
 - Convection bake -pg 24
 - Convection roast -pg 26-27
 - Convection broil -pg 30
 - Keep warm -pg 31
 - Slow cook -pg 32
4. Specialized cooking
 - Perfect turkey -pg 33
 - Defrost -pg 34
 - Dehydrate - pg 34
 - Bread proof -pg 35
5. Favorite settings -pg 36
6. Multi stage cooking -pg 37-38
7. Cook options
8. Cooking time
 - Cook time -pg 20
 - End time -pg 21
9. Probe -pg 28-29

10. Rapid preheat -pg 18
11. Convection convert -pg 25
12. Clean -pg 50-51

Minimum & maximum control settings		
Feature	Min. temp	Max. temp
Bake (upper)	170°F/76°C	550°F/288°C
Bake (lower)	170°F/76°C	450°F/232°C
Bread Proof	Lo (85°F/30°C)	Hi (100°F/38°C)
Broil	300°F/148°C	550°F/288°C
Conv Bake	170°F/76°C	550°F/288°C
Conv Roast	170°F/76°C	550°F/288°C
Conv Broil	300°F/148°C	550°F/288°C
Keep Warm	150°F/66°C	190°F/88°C
Slow Cook	Lo (225°F/108°C)	Hi (275°F/135°C)
Dehydrate	100°F/38°C	225°F/108°C
Perfect Turkey	300°F/148°C	550°F/288°C

Oven control display & keys

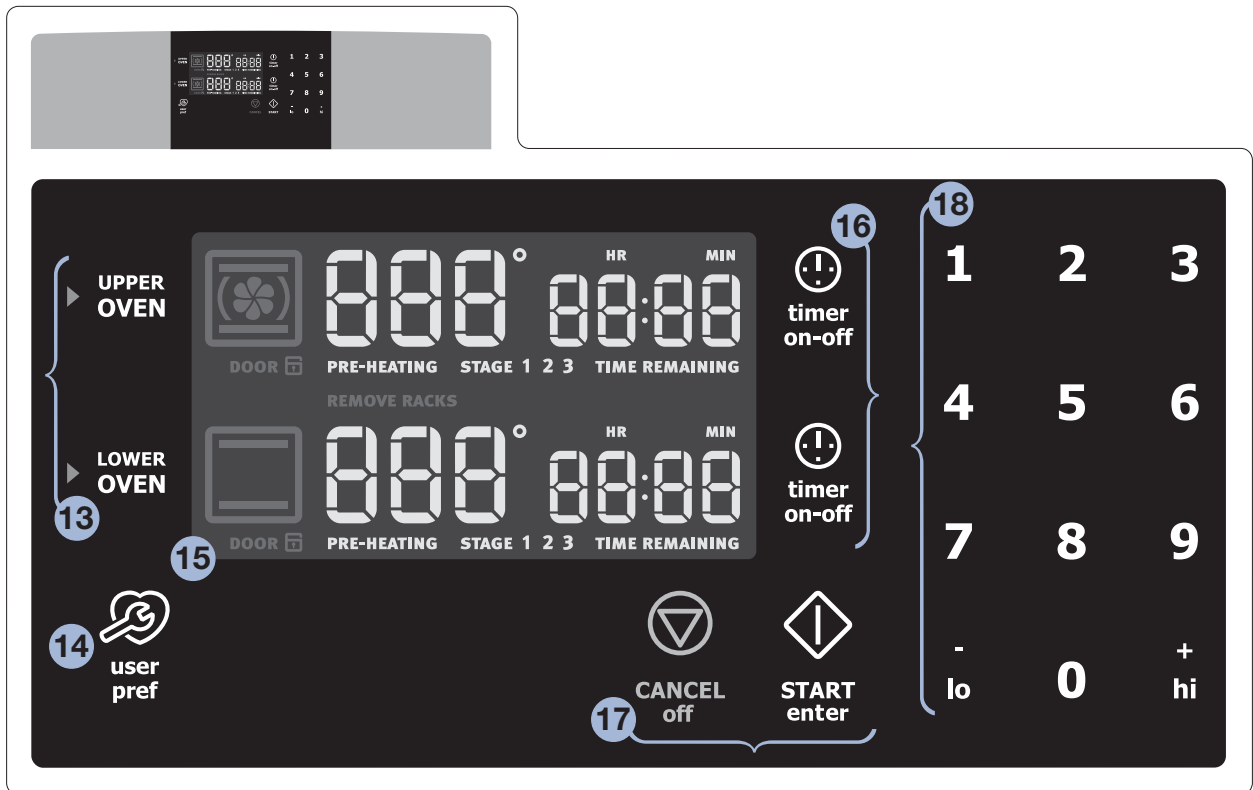

13. Perfect-Pair™ oven key pads

- Upper oven
- Lower oven

14. User preferences -pg 44-49

The following options are available under User Preferences:

- Clock setting -pg 11 & 44
- Clock display setting -pg 44
- 12 hr/ 24 hr -pg 45
- Fahrenheit/ Celcius -pg 45
- 12 Hr energy save mode on/off -pg 46
- Audio mode -pg 46
- UPO offset (temp. adjust) or reset -pg 47
- Factory default reset -pg 48

15. Oven display

16. Timers -pg 11

17. Cancel & Start

18. Numeric key pad

Minimum & maximum time settings		
Feature	Min. time	Max. time
Timer 1	1 min	11 hr 59 min
Timer 2	1 min	11 hr 59 min
Clock 12 hr	1:00 hr	11 hr 59 min
Clock 24 hr	0:00 hr	23 hr 59 min
Cook time 12 hr	1 min	11 hr 59 min
Cook time 24 hr	1 min	23 hr 59 min
End time 12 hr	1:00 hr	12 hr 59 min
End time 24 hr	0:00 hr	23 hr 59 min
Clean duration	Lite (2 hr)	Heavy (4 hr)

Wave-Touch™ Range features

Your gas range features include:

1. Wave-touch™ activated glass control panel.
2. Wave-touch™ electronic oven & surface controls & timers.
3. Dishwasher safe burner grates.
4. Easy to clean upswept deep well cooktop.
5. Left front burner valve & knob.
6. Left Rear burner valve & knob.
7. Center burner valve & knob.
8. Perfect-simmer™ right rear burner valve & knob.
9. Min-2-max™ right front burner valve & knob.
10. Sure-2-fit™ cobalt blue self-cleaning oven interior.
11. Self-clean oven door latch.
12. Automatic oven door light switch.
13. Theatre style Luxury-Lighting™ halogen upper oven interior lights.
14. Convection fan & cover.
15. 2 fully extendable Luxury-Glide™ interior oven racks.
16. 1 offset interior oven rack (not shown).
17. Oven glide rack sensor.
18. Large 1-piece metal oven door handles.
19. Color coordinated or stainless steel oven exterior panels & trim.
20. Full-width tinted oven door window glass.
21. Perfect-Pair™ lower oven.
22. Lower oven door window glass.
23. Leveling legs & anti-tip bracket (included).
24. Easy to clean upswept cooktop.
25. Broiler pan.
26. Broiler pan insert.
27. Convection roasting rack.
28. Cast iron griddle. (not shown-some models)

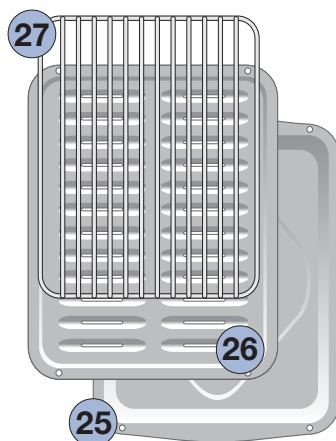
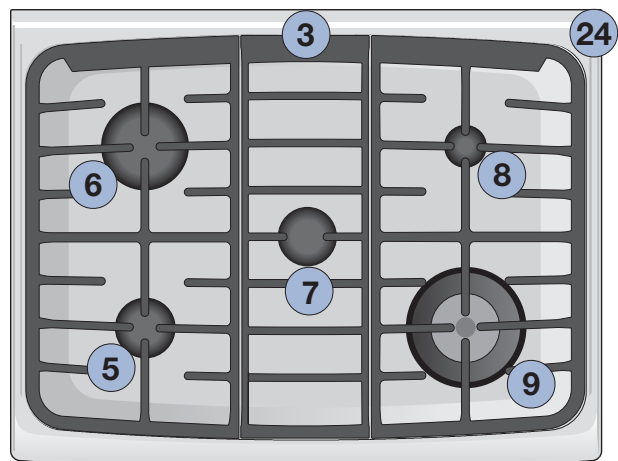
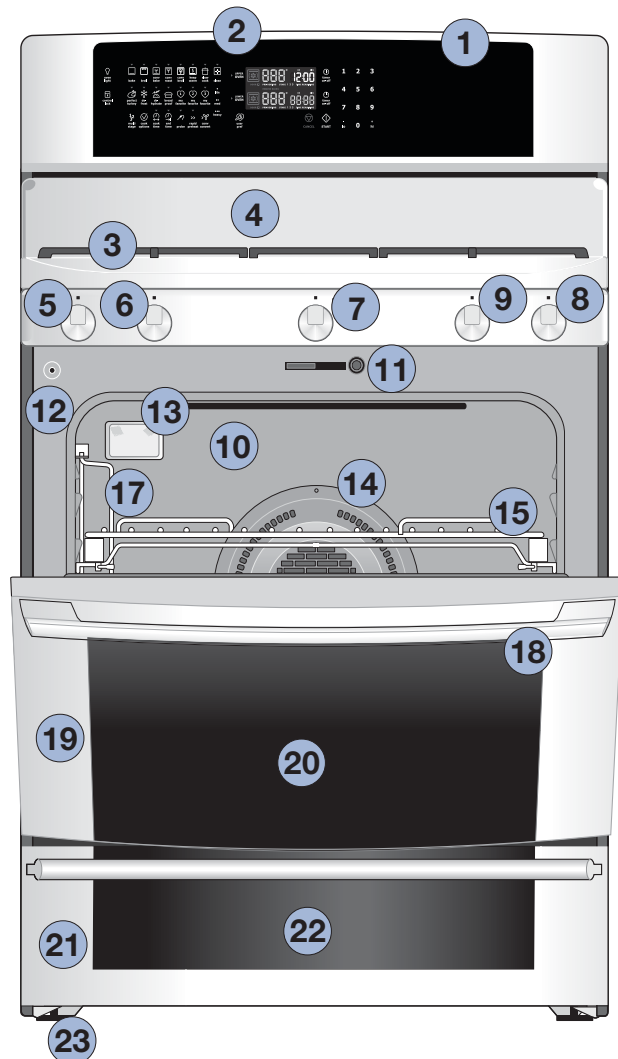

About the griddle (some models)

Your new appliance is supplied with a griddle. Use the raised grill side of the griddle -*Fig. 1*- to cook meats such as sausage, steak, bacon, or other items that produce grease when cooking. Use the smooth side of the griddle -*Fig. 2*- to cook pancakes, eggs or grilled cheese sandwiches.

The griddle will perform best on the left side, but may be used on the right side. Make sure that all burners are turned off before placing the griddle on the grates.

Before first use

1. Wash griddle in hot soapy water. Rinse and then dry completely.
2. Apply a thin coat of vegetable oil to the entire surface. Only season one side of the griddle at a time. Be sure to bake the seasoned side up.
3. Bake griddle for 1 hour at 350°F, then turn oven OFF and let cool before removing.
4. The surface may appear to have a tacky feel to it from the seasoning process. If desired, wash the griddle in hot soapy water, rinse well, and dry completely.

After each use

- **DO NOT CLEAN GRIDDLE IN DISHWASHER.**
- After each use, clean with a stiff brush and hot water only.
- Dry immediately and apply a light coating of vegetable oil to griddle before storing.
- To prevent rusting, store in a dry place and keep uncovered.

Using the griddle

- Place either side of the griddle centered over the left or right side of gas burner grates. Be sure locking tabs fit properly on top of grates -*Fig. 1*.
- Preheat the griddle for 5 minutes on medium to medium low setting. Slow preheat ensures even heat distribution during the cooking process.
- **DO NOT** preheat the griddle on HI burner setting. Preheating on HI may warp the griddle and prevent even heat distribution.

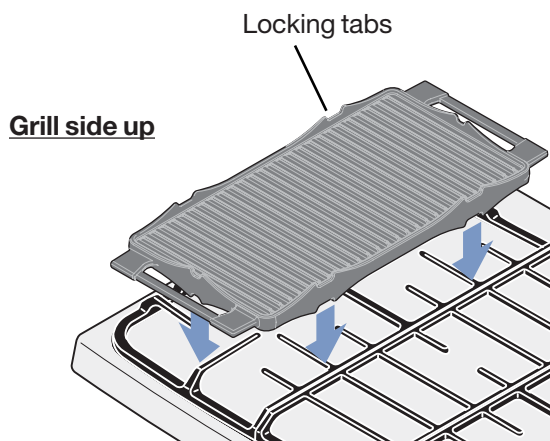

Fig. 1

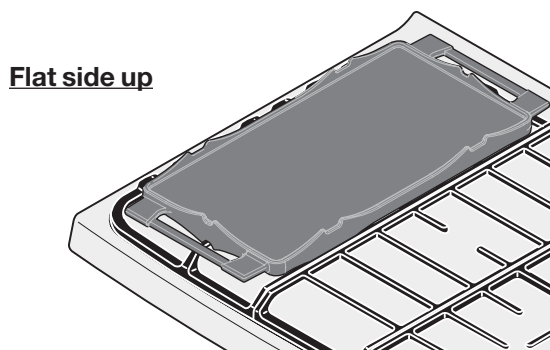

Fig. 2

Setting clock at power up

You will be prompted to enter the time of day in the event of a **power failure** or when you **first provide electric power** to your appliance.

- When your appliance is first powered up, 12:00 will flash in the display.
- Enter the time of day using the numeric key pads and press **START** to set.

If an invalid time of day is entered, the control will triple beep. Re-enter a valid time of day and press **START**. If **CANCEL** is pressed your clock will start with the time set for **12:00**.

Select the user pref key to modify the time of day during other situations such as day light savings.

Wave-Touch™ display modes

Sleep mode

Your control will remain in a sleep mode -*Fig. 1*- when not in use, unless there is a hot element. Only the clock will display during this mode. You will need to wake the control to begin any function.

Awake mode

To awake the control -*Fig. 2*- touch within the display panel. If the control panel is not touched again within 2 minutes, the control will return to the sleep mode. To start cooking you must select either the upper oven, lower oven, or a surface element. User preferences will be available during this mode as well as timers, oven light and the control lock.



Timers

The two timers provided with the oven control serve as extra reminders in the kitchen. When a timer reaches less than 1 minute the display will start to count down in seconds. When the time runs out the active timer will beep, "00:00" will display and the timer key will flash.

The following time settings apply to the timers:

- Min. time: 1 minute
- Max. time: 11 hours 59 minutes

See example below to set the timer for 5 minutes:

Example	
Step	Press
1. Press TIMER	
2. Enter 5 minutes	5
3. Press TIMER	

To cancel after setting the timer, press the **TIMER** key again.

NOTE

The timer(s) will not affect the cooking process.

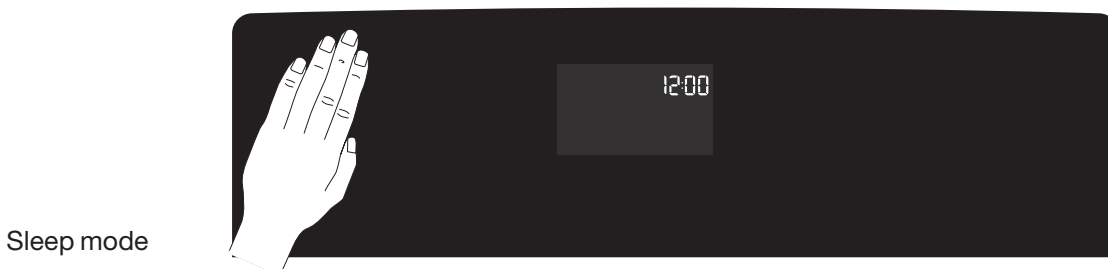

Sleep mode

Fig.1

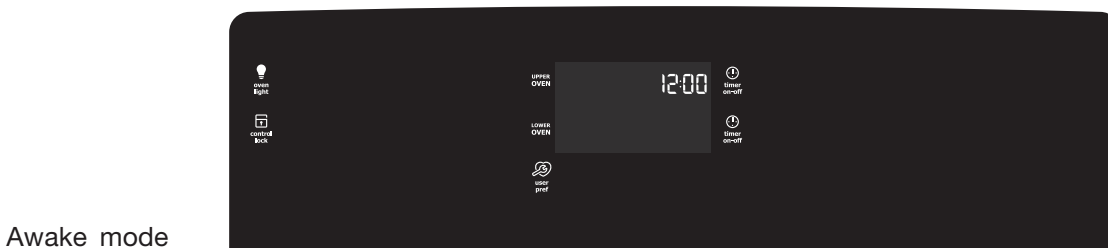

Awake mode

Fig.2

Choosing an oven

Software controls the upper and lower ovens so that both may be set to operate at the same time with unique settings. It is very important to understand that before setting or modifying either oven, you must first **select** which oven you desire to set or modify.

The display will provide which oven is currently **selected** for setting/changes by displaying a small red triangle indicator next to the upper or lower oven text -Fig 1.

If the upper oven text symbol displays the red triangle indicator but you wish to set or change the settings for the lower oven, press **LOWER OVEN** once to change the oven selection. Then make the setting/changes. You may toggle between either oven and make setting changes at any time. You may also make cooktop settings or modifications without having to make an oven selection.

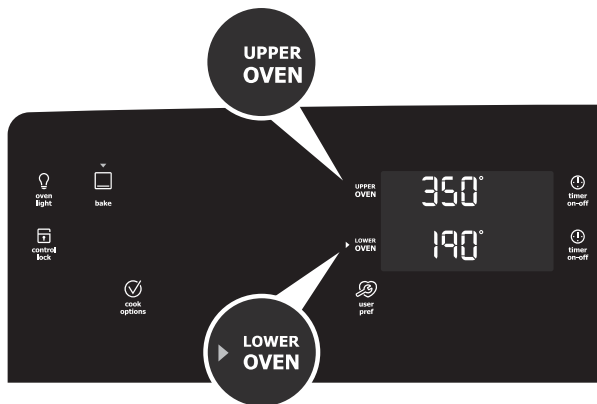



Fig.1

Preheat Temperature Display

Once a cooking feature has been started for either the upper or lower oven the control will display the actual oven temperature while preheating. Once the oven reaches the oven set temperature only the oven set temperature will display.

Interior Luxury-Lighting™

Your appliance includes “theater” style oven lighting that gradually lights both the upper and lower oven interiors to full brightness.

The  key controls the interior oven lights.

This model includes 2 halogen lights in the upper oven and one standard appliance light located on the rear wall of the lower oven.

The oven lights will automatically turn ON whenever the upper oven door is opened. The lights will remain on until the door has been shut.

To replace any of the interior light bulbs see “Changing the oven lights” in the **Care and Cleaning** section.

Control lock

The control will lock the oven controls and the upper oven door. Once locked, the upper oven light will not switch from on to off or off to on.

Control lock is available only in the awake mode. See example below to lock the upper oven and the cooktop:

Example	
Step	Press

Press **CONTROL LOCK** and hold for 3 seconds.



To unlock, Press **CONTROL LOCK** and hold for 3 seconds.

DOOR  will flash in the display until the door has finished locking. Once the door has been locked the door lock indicator will turn on. LOC will then display in the upper oven cavity only.

Do not attempt to open the oven door while the door lock indicator is flashing.

Upper oven racks

Types of oven racks

Your appliance is equipped with 2 styles of interior oven racks; 1 offset oven rack and 2 fully extendable **Luxury-Glide™** oven racks.

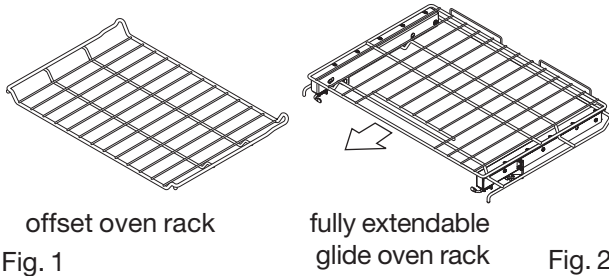

CAUTION

Always use potholders or oven mitts when removing food or adjusting the oven racks. Wait until the oven has completely cooled if possible. Oven racks may be **HOT** and may cause burns.

The **offset** -Fig. 1- oven rack may be used in all of the rack positions. The offset design provides additional height options. For maximum available space if preparing a large turkey, it is suggested to place the rack near the oven bottom (rack positions 1 or 2) - refer to Fig. 3. Do not extend the offset rack past the oven door when in the lowest rack position.

The fully extendable **glide** racks -Fig. 2- make food preparation easier. Especially when preparing heavier dishes. The glide oven rack has 2 glide tracks that allow you to extend your food away from the oven effortlessly without rubbing the sides of the oven wall.

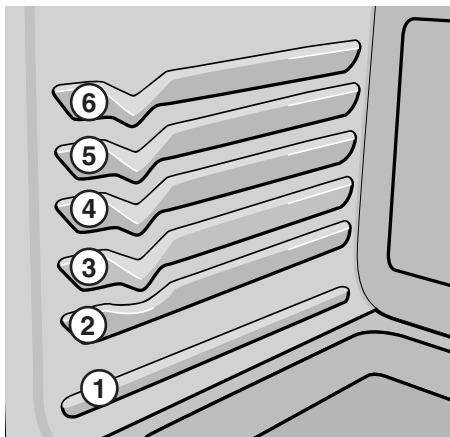

Fig. 3

Baking layer cakes with 1 or 2 oven racks

For best results when baking cakes using 2 oven racks, place cookware on rack positions 2 & 4 - refer to Fig. 3. For best results when using an offset oven rack, place cookware on rack position 2 or 3.

Air circulation in the oven

For best air circulation and baking results allow a space of 2-4" (5-10 cm) around the cookware for proper air circulation and be sure pans and cookware do not touch each other, the oven door, sides or back of the oven cavity. The hot air must be able to circulate around the pans and cookware in the oven for even heat to reach around the food.



Fig. 4 - Proper pan spacing using single oven rack.



Fig. 5 - Proper pan spacing using 2 oven racks.

Upper oven racks

CAUTION

Always use potholders or oven mitts when removing food or adjusting the oven racks. Wait until the oven has completely cooled if possible. Oven racks may be **HOT** and may cause burns.

Removing and replacing the offset rack (not illustrated)

- **To remove** pull the oven rack straight forward until it reaches the stop position. Lift up front of oven rack slightly and slide out.
- **To replace**, fit the oven rack onto the rack guides on the oven walls. Tilt the front of the rack upward slightly and slide the oven rack completely back into place (not shown).

Removing and replacing the Luxury-Glide™ oven racks

- **To remove** use thumbs to press in on both left and right spring-loaded release levers -*Fig. 1*. Place the remainder of both hands over the upper front of the glide rack. While pressing in on both levers, pull the rack straight out **slightly** and release thumb levers. Using both hands grasp **both the upper and lower portions** of the glide rack -*Fig. 1*; pull rack using both hands straight out until reaching the stop position -*Fig. 2*. At the stop, lift up front of rack slightly and continue to pull rack away from oven -*Fig. 3*. Be sure to hold on both upper and lower rack portions when removing from or handling rack outside of the oven - these rack portions move independently and are difficult to handle unless held together.
- **To replace**, grasping **both upper and lower portions** of glide rack, lift and place the rack resting evenly between the oven cavity walls. Tilt the front of the rack upward slightly and slide the rack completely into position. Some force may be necessary to make sure the oven rack has snapped completely back into place.

NOTE

DO NOT attempt to close the oven door until all the oven racks are properly positioned inside the oven cavity. Be sure the glide oven racks make contact with the vertical rack sensor located at the left rear oven cavity wall (see *item #17, page 9*).

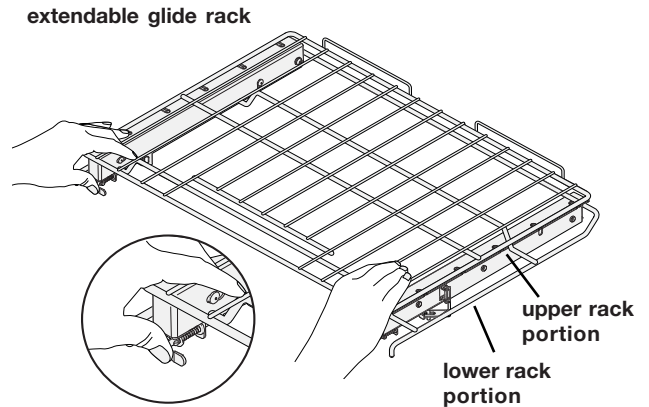

Fig. 1

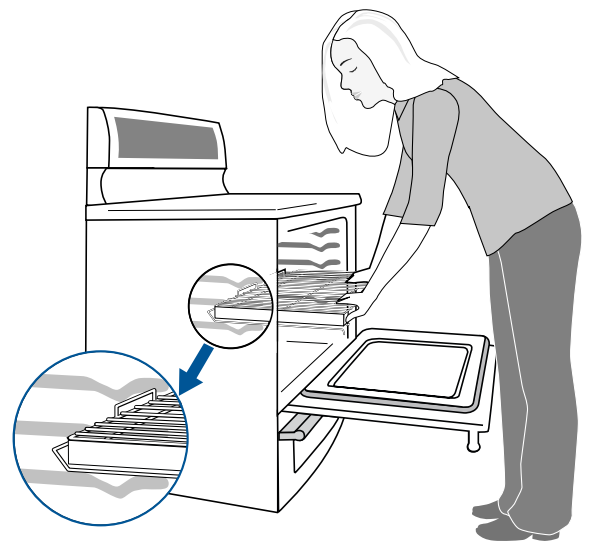

Fig. 2

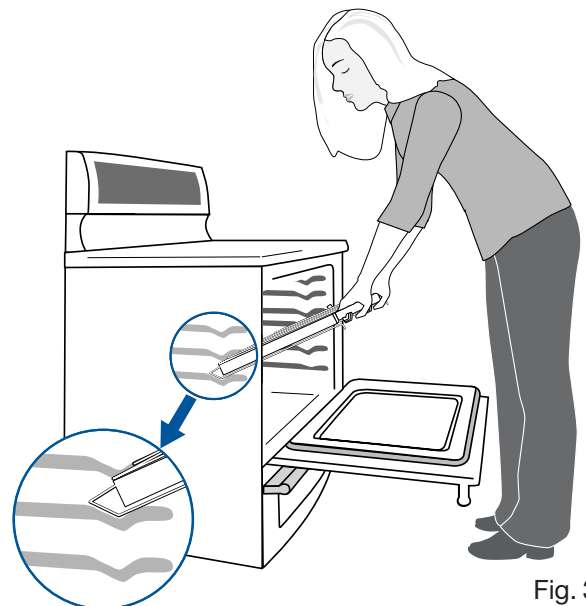

Fig. 3

Cookware

Using proper cookware

The size and type of cookware used will influence the setting needed for best cooking results. Cookware should have flat bottoms that make good contact with the entire grate surface. Check for flatness by rotating a ruler across the bottom of the cookware.



Cookware should always:

- Have a flat bottom.
- Have tight fitting lids.
- Be well balanced.
- Be made of a material that conducts heat well.
- Be easy to clean.

Oven vent location

The oven vent is located below the backguard. When the oven is on, warm air is released through this vent. This venting is necessary for proper air circulation and provides good baking results in the oven. **DO NOT BLOCK THIS VENT.**

Oven vent location

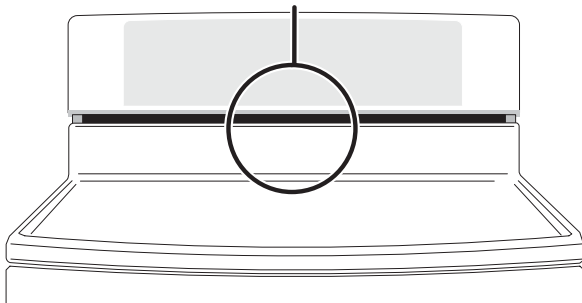

Cookware material types

The cookware material determines how evenly and quickly heat is transferred from the surface element to the pan bottom. The most popular materials available are:

- **Aluminum** - Excellent heat conductor. Some types of food will cause it to darken (Anodized aluminum cookware resists staining & pitting).
- **Copper** - Excellent heat conductor but discolors easily.
- **Stainless steel** - Slow heat conductor with uneven cooking results. Is durable, easy to clean and resists staining.
- **Cast iron** - A poor heat conductor however will retain heat very well. Cooks evenly once cooking temperature is reached.
- **Porcelain-enamel on metal** - Heating characteristics will vary depending on base material.
- **Glass** - Slow heat conductor.

Operating single burners

1. Push the desired gas surface control knob in and turn counterclockwise out of the OFF position - *Fig.1.*
2. Release knob and rotate to ☆ (lite) position. Visually check that the needed burner has lit.
3. To adjust, push the knob in and turn counterclockwise to a flame size setting that best fits your need.

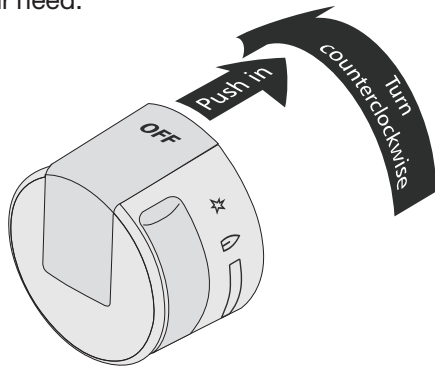
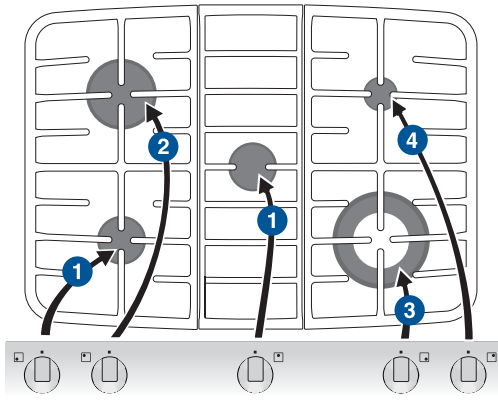

Fig. 1

Burner locations

- 1 Standard burners -9,500 BTU- best for most surface cooking requirements.
- 2 Large burner -14,000 BTU- best for bringing large quantities of liquid to boil or when preparing large quantities of food.
- 3 Min-2-Max™ double burner -18,000 BTU- Capabilities of large burner combined with a simmer burner.
- 4 Perfect Simmer™ burner -5,000 BTU- best for simmering delicate sauces, melting chocolates, etc.



Operating Min-2-Max™ double burner

1. Push right front surface control knob in and turn counterclockwise out of the OFF position -*Fig. 1.*
2. Release the knob and rotate to the ☆ (lite) position. Note: Although all electronic surface igniters will spark at the same time, only the selected surface burner will lite.
3. Visually check that both the inner and outer rings are lit -*Fig. 4.*

When both burners are lit, continue to turn the control knob counterclockwise to adjust to the desired flame size.

4. If only the inner burner is needed, continue to rotate the gas control knob counterclockwise somewhere past grey area -*Fig. 2.*

5. Adjust the inner flame to desired size -*Fig. 3.*

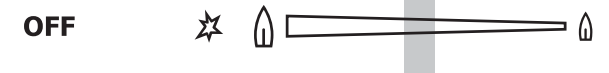

Fig. 2

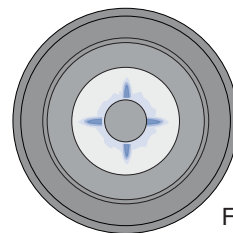

Fig. 3

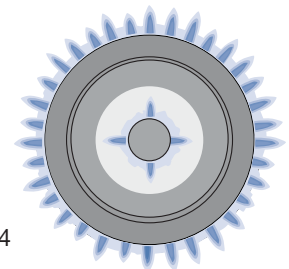

Fig. 4

List of displayed abbreviations

See the chart below for common abbreviations that you may see while using your appliance.

Abbreviations Chart	
Message	Message explanation
CLn	Self clean
CLO	Setting the clock
dEF	Defrost
d-O	Door open
End	End of cycle
F10*	Fault code error
HE	Hot element
Hi	Hi setting
Hot	Hot oven
Lo	Lo setting
Loc	Control lock
SAb	Sabbath mode
Sd	Demo mode
SF	Sabbath mode failure
CF	Check food

*This is an example of a fault code that you may see. These codes will help your servicer repair your appliance.

18 Setting Oven Controls

About rapid preheat

Use the rapid preheat option on **single rack baking** to quickly bring the upper oven to baking temperature.

The rapid preheat option may be set with the following cooking features:





- Bake
- Conv bake
- Conv roast

The following temperature settings apply to the rapid preheat feature:

- Auto-suggest (default) setting: **350°F / 176°C**
- Min. rapid preheat setting: **170°F / 76°C**
- Max. rapid preheat setting: **550°F / 288°C**

Setting rapid preheat

See example below to set a rapid preheat with bake to start immediately using default temperature.

Example	
Step	Press
1. Press UPPER OVEN	UPPER OVEN
2. Press BAKE	
3. Press COOK OPTIONS	
4. Press RAPID PREHEAT	
5. Press START/enter	

When START is pressed the oven will preheat quickly. The control will display PRE-HEATING during this time. While PREHEATING the Convection fan may operate.

After a few minutes a beep will sound and PRE-HEATING will no longer display. Place prepared food on a single oven rack. The oven will continue to bake at the set temperature until bake is canceled.

NOTE

You may press CANCEL at any time when setting the control or during the cooking process.

To add or change any cook settings after this feature has started:

- Wake control panel from the sleep mode if necessary.
- Select the **UPPER** or **LOWER** oven you wish to change. Make temperature changes using the + or - keys. Each press of + or - will adjust the temperature by 5° F (or 2°C).
- If changing cooking times, select the **cook time** or **end time** keys needed to make the changes.



For best results

- **Single oven rack cooking ONLY.**
- Use in oven rack positions 2 or 3.

About baking in upper oven

Use the bake feature to cook most food items that require normal cooking temperatures.

Bake may be set with the following options:



- Rapid preheat
- Cook time
- Cook time with end time
- Probe

The following temperature settings apply to the bake feature:

- Auto-suggest (default) setting: **350°F / 176°C**
- Min. bake setting: **170°F / 77°C**
- Max. bake setting: **550°F / 288°C**

Setting bake for upper oven



See example below to set a bake to start immediately using the default temperature.

Example	
Step	Press
1. Press UPPER OVEN	UPPER OVEN
2. Press BAKE	
3. Press START/enter	

Once **START** is pressed the oven will begin heating. The oven display shows **PRE-HEATING**. While **PREHEATING** the Convection fan may operate.

After the oven reaches set temperature, **PRE-HEATING** will turn off and a beep will indicate the oven is ready. The oven will continue to maintain this temperature until the cooking feature is canceled.

If your recipe requires a different baking temperature than the auto-suggested (default) temperature (example below shows upper oven temperature set for 425°F/218°C).

Example	
Step	Press
1. Press UPPER OVEN	UPPER OVEN
2. Press BAKE	
3. Enter 425°F	425
4. Press START/enter	



For best results

- Place food items in rack positions 2 or 4.
- When using the offset oven rack, place in rack position 2 or 3.
- When placing multiple food items in the oven allow 2-4" (5-10cm) of space between the food items for proper air circulation.
- For best results when baking cakes using 2 oven racks, place cookware on rack positions 2 & 4.

NOTE

You may press **CANCEL** any time when setting the control or during the cooking process.

To add or change any cook settings after this feature has started:

- Wake control panel from the sleep mode if necessary.
- Select the **UPPER** or **LOWER** oven you wish to change. Make temperature changes using the **+** or **-** keys. Each press of **+** or **-** will adjust the temperature by 5° F (or 2°C).
- If changing cooking times, select the **cook time** or **end time** keys needed to make the changes.

Using cook time in upper oven

Adding a cook time when baking is beneficial when a recipe requires a specific temperature and period of time to cook. Following the recipe cook time helps insure the best possible results.







Cook time may be set with the following features:

- Bake
- Conv bake
- Conv roast
- Slow cook
- Defrost
- Dehydrate
- Bread proof
- Keep warm

NOTE

- You may press CANCEL any time when setting the control or during the cooking process.

See example below to set the upper oven for bake, starting immediately with preheating to the auto-suggest (default) setting of 350°F (176°C) and then to automatically turn off after 30 minutes.

Example	
Step	Press
Preheat the oven if necessary	
1. Press UPPER OVEN	
2. Press BAKE	
3. Press START	
4. Press COOK OPTIONS	
5. Press COOK TIME	
6. Enter 30 minutes	30
7. Press START/enter	

Once START is pressed the oven will cook and after 30 minutes automatically shut-off.

Using cook time with end time in upper oven

Adding a cook time along with a specific end time gives the same benefits as the cook time option in addition to controlling exactly when the cooking process will begin and end.





Cook time and end time may be set with the following features:

- Bake
- Convection bake
- Convection roast
- Slow cook
- Clean (delayed Clean uses end time only)
- Defrost
- Dehydrate
- Bread proof
- Keep warm

NOTE

- When setting the END TIME option be sure the correct time of day is set.
- You may press CANCEL any time when setting the control or during the cooking process.
- You may also choose to use **COOK TIME** with no **END TIME**. See pg. 20

See example below to set the upper oven with preheating for bake at 375°F (176°C) for 50 minutes and to automatically shut-off at 5:30.

Example	
Step	Press
1. Press UPPER OVEN	UPPER OVEN
2. Press BAKE	
3. Enter 375°F	375
4. Press COOK OPTIONS	
5. Press COOK TIME	
6. Enter 50 minutes	50
7. Press END TIME	
8. Enter 5:30	530
9. Press START/enter	

Once START is pressed, the oven will calculate the start time at which the oven will begin heating. The oven display shows PRE-HEATING. While PREHEATING the Convection fan may operate.

After the oven reaches set temperature, PRE-HEATING will turn off and a beep will indicate the oven is ready. The oven will continue to maintain this temperature for the selected time or until the cooking feature is canceled.

About broiling

Use the broil feature to cook meats that require direct exposure to radiant heat for optimum browning results. This cooking feature is only available in the upper oven.

The following temperature settings apply to the broil feature:

- Auto-suggest (default) setting: **550°F / 288°C**
- Min. broil setting: **300°F / 148°C**
- Max. broil setting: **550°F / 288°C**

WARNING

Should an oven fire occur, close the oven door. If the fire continues, throw baking soda on the fire or use a fire extinguisher. **Do not** put water or flour on the fire. Flour may be explosive and water can cause a grease fire to spread and cause personal injury.

CAUTION

- **Do not** use the broiler pan without the insert.
- **Do not** cover the the broil pan/insert with aluminum foil; the exposed grease could ignite.
- To prevent food from contacting the broil element and to prevent grease splattering, **do not** use the roasting rack when broiling.





For best results

- Use the recommended pans and oven rack positions for the type of meat being prepared - *p.23 Figs. 2 & 4.*
- For optimum browning results, allow the oven to preheat **5-6 minutes** before placing the food in the oven.

Setting broil

See example below to set broil for the upper oven starting immediately with the auto-suggest (default) setting.

Example	
Step	Press
1. Place the broiler insert on the broiler pan, then place the meat on the insert. Remember to follow all warnings and cautions.	
2. Arrange the interior oven rack - <i>p. 23 Figs. 2 & 4</i> for position recommendations. Be sure to place the prepared food and pan directly under broil element. Close the oven door. - <i>p. 23 Fig. 1-</i>	
3. Press UPPER OVEN	UPPER OVEN
4. Press BROIL	
5. Press START/enter	

NOTE

You may press CANCEL any time while setting the control or during the broiling process.

To add or change any cook settings after this feature has started:

- Wake control panel from the sleep mode if necessary.
- Select the **UPPER** or **LOWER** oven you wish to change. Make temperature changes using the + or - keys. Each press of + or - will adjust the temperature by 5° F (or 2°C).
- If changing cooking times, select the **cook time** or **end time** keys needed to make the changes.

Setting broil

The broil pan insert (if equipped) contains slots that allows grease from the meat to drain into the broil pan. Place prepared meat on broil pan insert and then place onto broiler pan as shown -Fig. 3.

Recommended broiling times

Use the broiling table -Fig. 2- for approximate recommended broiling times for the types of meats listed. Increase or decrease broiling times, or move the broiling pan to a different rack position to suit for doneness.

If the food you are broiling is not listed in the table, follow the instructions provided in your recipe and watch the item closely.

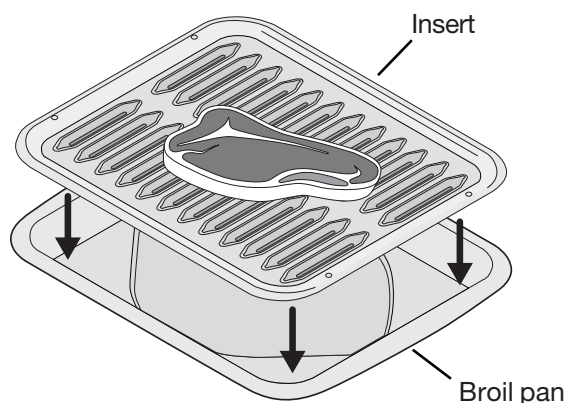
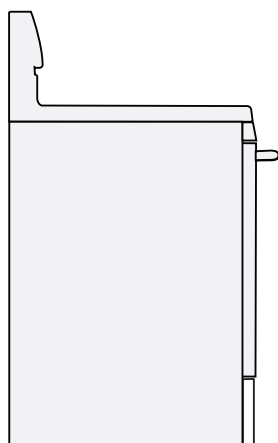

Fig. 3



For broil- close the oven door
Fig. 1

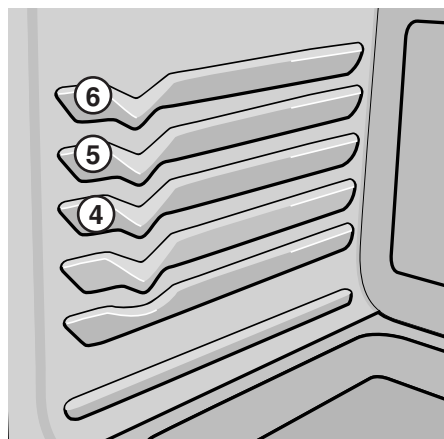

Fig. 4

Broiling Table					
Food	Rack position	Temp	Cook time in minutes		Doneness
			1st side	2nd side	
Steak 1" thick	4th or 5th*	550°F	6	4	Medium
Steak 1" thick	4th or 5th*	550°F	7	5	Medium-well
Steak 1" thick	4th or 5th*	550°F	8	7	Well
Pork chops 3/4" thick	5th	550°F	8	6	Well
Chicken-bone in	4th	450°F	20	10	Well
Chicken-boneless	5th	450°F	8	6	Well
Fish	5th	500°F	13	n/a	Well
Shrimp	4th	550°F	5	n/a	Well
Hamburger 1" thick	5th*	550°F	9	7	Medium
Hamburger 1" thick	5th	550°F	10	8	Well

*Use the off-set rack if you choose to use oven rack position 6.

Fig. 2

About convection bake

Convection bake is part of the Perfect-Convect³™ system. Convection bake uses a fan to circulate the oven heat evenly and continuously. The improved heat distribution allows for even cooking with excellent results. Multiple rack cooking may slightly increase cook times for some foods, but the overall result is time saved.

The conv bake feature should **ONLY** be used when your recipe instructions have been written for use with convection baking.

If your recipe instructions are for normal baking and you wish to use convection bake, follow the **Convection Convert** option instructions. The convection convert option will automatically adjust the oven temperature so that convection baking may provide the best possible results.

Conv bake may be set with the following options:

- Conv convert
- Cook time or cook time with end time
- Probe
- Rapid preheat

Benefits of convection bake:

- Superior multiple oven rack performance.
- Some foods cook up 25 to 30% faster, saving time and energy.
- No special pans or bakeware required.

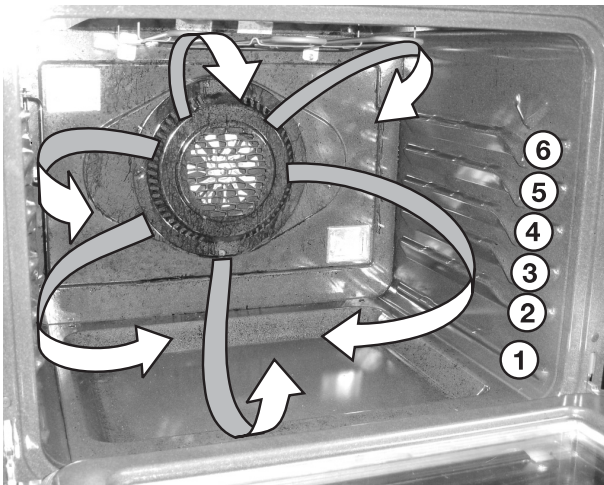

Setting convection bake

The following temperature settings apply to the conv bake feature:

- Auto-suggest (default) setting: **350°F / 176°C**
- Min. bake setting : **170°F / 76°C**
- Max. bake setting: **550°F / 288°C**

See the example below to set conv bake, starting immediately with the auto-suggest (default) setting of 350°F (176°C).

Example	
Step	Press
1. Press UPPER OVEN	UPPER OVEN
2. Press CONV BAKE	
3. Press START/enter	

Once **START** is pressed the oven will begin heating. The oven display shows **PRE-HEATING** during this time.

After the oven reaches set temperature, **PRE-HEATING** will turn off and a beep will indicate the oven is ready. The oven will continue to maintain this temperature until the cooking feature is canceled.



For best results

- When baking with a single rack use rack positions 2 or 3. When using 2 racks use rack positions 2 & 4. When using 3 racks use rack positions 2, 3 & 5.
- Cookies and biscuits should be baked on pans with no sides or very low side to allow heated air to circulate around the food.
- Food baked on pans with a dark finish will cook faster.
- When placing multiple food items in the oven allow 2-4" (5-10cm) of space between the food items for proper air circulation.

NOTE

- You may press CANCEL any time when setting the control or when cooking.

Using convection convert

The conv convert option allows you to convert any normal baking recipe using the convection bake feature. The control uses the normal recipe settings and adjusts to a lower temperature for convection baking. Conv convert must be used with CONV BAKE feature.

Benefits of conv bake using conv convert option:

- Superior multiple oven rack performance.
- Some foods cook up 25 to 30% faster, saving time and energy.
- No special pans or bakeware required.



For best results

- Place food items using the recommended rack positions. When baking with a single rack use rack positions 2 or 3. When using 2 racks use rack positions 2 and 4. When using 3 racks use rack positions 2, 3 and 5.
- Cookies and biscuits should be baked on pans with no sides or very low side to allow heated air to circulate around the food.
- Food baked on pans with a dark finish will cook faster.
- When placing multiple food items in the oven allow 2-4" (5-10cm) of space between the food items for proper air circulation.







NOTE

- You may press CANCEL any time when setting the control or during the cooking process.

Setting convection convert

See the example below to set conv bake, starting immediately with the auto-suggest (default) setting of 350°F (176°C) and adding the conv convert option.

Example	
Step	Press
1. Press UPPER OVEN	
2. Press CONV BAKE	
3. Press COOK OPTIONS	
4. Press CONV CONVERT	
5. Press START/enter	

Once **START** is pressed the oven display shows **PRE-HEATING**. After the oven reaches the converted set temperature, **PRE-HEATING** will turn off and a beep will indicate the oven is ready.

The added conv convert option will automatically **lower** the set temperature you set from the bake recipe to an adjusted conv bake temperature.

When conv convert is used with cook time the time remaining will flash when the cook time is 75% complete. The control will also beep at regular intervals until baking has finished.

To add or change any cook settings after this feature has started:

- Wake control panel from the sleep mode if necessary.
- Select the **UPPER** or **LOWER** oven you wish to change. Make temperature changes using the + or - keys. Each press of + or - will adjust the temperature by 5° F (or 2°C).
- If changing cooking times, select the **cook time** or **end time** keys needed to make the changes.

About convection roast

How convection roast works

Convection roast is part of the Perfect-Convect³™ system. Convection roast combines a cook cycle with the convection fan and element to rapidly roast meats and poultry. Heated air circulates around the meat from all sides, sealing in juices and flavors. Meats cooked with this feature are crispy brown on the outside while staying moist on the inside. In addition, there is no need to reduce the oven temperature when using convection roast.

Convection roast may be set with the following options:

- Probe
- Cook time or cook time with end time
- Rapid preheat

The following temperature settings apply to convection roast:

- Factory auto-start default: **350°F / 176°C**
- Minimum: **170°F / 76°C**
- Maximum: **550°F / 288°C**

Benefits of convection roast:

- Superior multiple oven rack performance.
- Some foods cook up 25 to 30% faster, saving time and energy.
- No special pans or bakeware required.





For best results

- Preheating is not necessary for most meats and poultry.
- Place food items using the recommended rack positions for the type of food being prepared.
- When placing multiple food items in the oven allow 2-4" (5-10cm) of space between the food items for proper air circulation.
- Be sure to carefully follow your recipe's temperature and time recommendations or refer to the convection roast chart for additional information -p. 27, Fig. 2.

Setting convection roast

See example below to set convection roast to start immediately with the auto-suggest (default) setting.

Example	
Step	Press
1. Press UPPER OVEN	
2. Press CONV ROAST	
3. Press START/enter	

Once START is pressed the oven will begin heating. The oven display shows PRE-HEATING.

After the oven reaches set temperature, PRE-HEATING will turn off and a beep will indicate the oven is ready.

NOTE

- You may press CANCEL any time when setting the control or during the cooking process.

To add or change any cook settings after this feature has started:

- Wake control panel from the sleep mode if necessary.
- Select the **UPPER** or **LOWER** oven you wish to change. Make temperature changes using the + or - keys. Each press of + or - will adjust the temperature by 5° F (or 2°C).
- If changing cooking times, select the **cook time** or **end time** keys needed to make the changes.

Roasting recommendations

Roasting rack instructions

When preparing meats for convection roasting, you may use the broiler pan, insert and the roasting rack supplied with your appliance. The broiler pan will catch grease spills and the insert will help prevent grease splatters. The roasting rack fits on top of the insert allowing the heated air to circulate under the food for even cooking and helps to increase browning on the underside.

1. Place oven rack on bottom or next to the bottom oven rack position.
2. Place the insert on the broiler pan.
3. Make sure the roasting rack is securely seated on top of the insert. **Do not** use the broiler pan without the insert. **Do not** cover the insert with aluminum foil.
4. Position food (fat side up) on the roasting rack. *-Fig. 1-*
5. Place prepared food on oven rack in the oven.

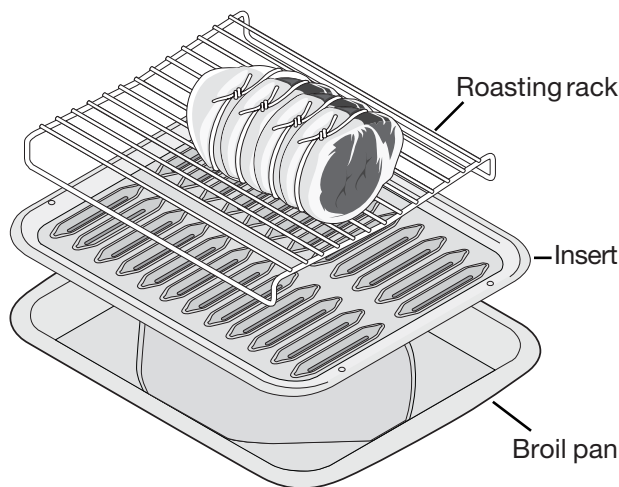

Fig. 1

Convection Roasting Chart					
Meat		Weight	Oven temp	Internal temp	Minute per lb.
Beef	Standing rib roast	4 to 6 lbs.	350°F	*	25-30
	Rib eye roast	4 to 6 lbs.	350°F	*	25-30
	Tenderloin roast	2 to 3 lbs.	400°F	*	15-25
Poultry	Turkey, whole**	12 to 16 lbs.	325°F	180°F	8-10
	Turkey, whole**	16 to 20 lbs.	325°F	180°F	10-15
	Turkey, whole**	20 to 24 lbs.	325°F	180°F	12-16
	Chicken	3 to 4 lbs.	350°F -375°F	180°F	12-16
Pork	Ham roast, fresh	4 to 6 lbs.	325°F	160°F	30-40
	Shoulder blade roast	4 to 6 lbs.	325°F	160°F	20-30
	Loin	3 to 4 lbs.	325°F	160°F	20-25
	Pre-cooked ham	5 to 7 lbs.	325°F	160°F	30-40

* For beef: med rare 145°F, med 160°F, well done 170°F

Fig. 2

** Stuffed turkey requires additional roasting time. Shield legs and breast with foil to prevent overbrowning and drying of the skin.

About the probe function

Checking the internal temperature of your food is the most effective way of insuring that your food has been properly cooked. When cooking meat such as roasts, hams or poultry you can use the probe to check the internal temperature without any guesswork.

Your oven will automatically change from cooking to keep warm once the probe has reached the set temperature.

The following temperature settings apply to the probe function:

- Default: **170°F / 76°C**
- Minimum: **130°F / 54°C**
- Maximum: **210°F / 98°C**

Setting the probe

Proper probe placement

- Always insert the probe so that the tip rests in the center of the thickest part of the meat. Do not allow the probe to touch bone, fat, gristle or the pan.
- For bone-in ham or lamb, insert the probe into the center of the lowest large muscle or joint. For dishes such as meat loaf or casseroles, insert the probe into the center of the food. To find the center of the food visually measure with the probe -Fig. 3. When cooking fish, insert the probe just above the gill.
- For whole poultry or turkey, insert the probe into the thickest part of the inner thigh, below the leg -Fig. 1.

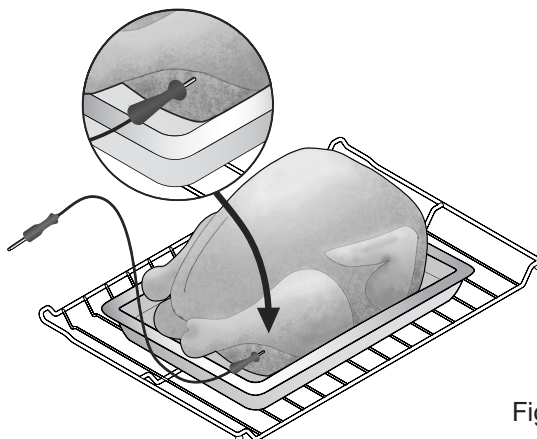

Fig. 1

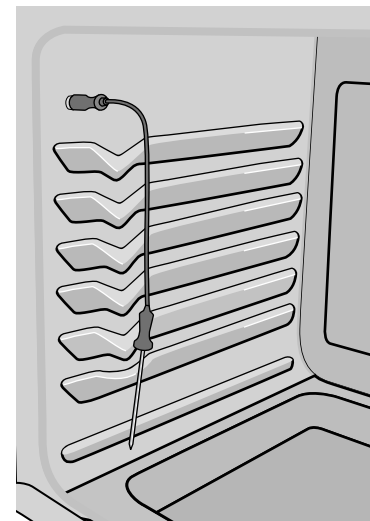

Fig. 2

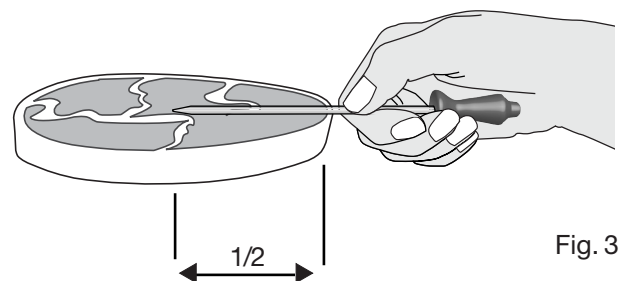

Fig. 3





IMPORTANT

- Use only the probe supplied with your appliance; any other may result in damage to the probe or the appliance.
- Be sure the probe is **fully** inserted into the probe receptacle. The probe will not work properly until correctly connected.
- Handle the probe carefully when inserting and removing it from the food and the receptacle.
- Do not use tongs to pull the cable when inserting or removing it from the food or the receptacle.
- Defrost your food completely before inserting the probe to avoid damaging probe.
- **Never leave or store the probe inside the oven when not in use.**
- To prevent the possibility of burns, carefully unplug the probe using a pot holder.

Setting the probe

See the example below to set the probe target temperature to 180°F/82°C when using the convection roast feature with oven set temperature for 325°F/162°C.

By the default, your oven will adjust to the **keep warm** setting once the probe has reached the set temperature.

Example	
Step	Press
1. Insert the probe into the food and place the food into the oven -p. 28, Fig. 1-	
2. Plug the probe COMPLETELY into the probe receptacle inside the oven and close the door. -p. 28, Fig. 2-	
3. Press UPPER OVEN	UPPER OVEN
4. Press CONV ROAST	
5. Enter 325	325
6. Press COOK OPTIONS *	
7. Press PROBE	
8. Enter 180	180
9. Press START/enter	

NOTE

Any time during the cooking process you may press PROBE once to see the current internal meat temperature reported by the probe. Press PROBE twice to review or change the probe target temperature.

*You may skip steps 6-9 if you choose to use the default internal target temperature of 170°F for the probe.

About convection broiling

Convection broiling is part of the Perfect-Convect³™ system. Use the conv broil feature to cook thicker cuts of meats that require direct exposure to radiant heat and the convection fan for optimum browning results. This cooking feature is only available for the upper oven.

The following temperature settings apply to the conv broil feature:

- Auto-suggest (default) setting: **550°F / 288°C**
- Min. convection broil setting: **300°F / 148°C**
- Max. convection broil setting: **550°F / 288°C**

WARNING

Should an oven fire occur, leave the oven door closed and turn the oven OFF. If the fire continues, throw baking soda on the fire or use a fire extinguisher. **Do not** put water or flour on the fire. Flour may be explosive and water can cause a grease fire to spread and cause personal injury.

CAUTION

- **Do not** use the broiler pan without the insert. **Do not** cover the the broil pan or insert with aluminum foil; the exposed grease could ignite.
- To prevent food from contacting the broil element and to prevent grease splattering, **do not** use the roasting rack when broiling.





For best results

- Use the recommended pans and rack positions. -p.23 Figs. 2 & 4-
- For optimum results preheat oven for 5-6 minutes.

Setting convection broil

See example below to set conv broil for the upper oven to start immediately with the auto-suggest (default) setting.

Example	
Step	Press
1. Place the broiler insert on the broiler pan, then place the meat on the insert. Remember to follow all warnings and cautions.	
2. Arrange the interior oven rack -p. 23 Figs. 2 & 4- for position recommendations. Be sure to place the prepared food and pan directly under broil element. Close the oven door -p. 23 Fig. 1.	
3. Press UPPER OVEN	
4. Press CONV BROIL	
5. Press START/enter	

NOTE

You may press CANCEL any time when setting the control or during the cooking process.

To add or change any cook settings after this feature has started:

- Wake control panel from the sleep mode if necessary.
- Select the **UPPER** or **LOWER** oven you wish to change. Make temperature changes using the + or - keys. Each press of + or - will adjust the temperature by 5° F (or 2°C).
- If changing cooking times, select the **cook time** or **end time** keys needed to make the changes.

About keep warm

Use the keep warm feature to keep hot foods warm. Keep warm may be set with the following options:

Keep warm may be set the following options:

- Cook time
- Cook time with end time

The following temperature settings apply to the keep warm feature:

- Auto-suggest (default) setting: **170°F / 76°C**
- Min. keep warm setting: **150°F / 66°C**



WARNING

- **FOOD POISONING HAZARD. Do not let food sit for more than one hour before or after cooking. Doing so may cause bacteria to grow which can result in food poisoning or sickness.**
- To prevent food from contacting the broil element and to prevent grease splattering, **do not** use the roasting rack when broiling.





NOTE

You may press CANCEL any time when setting the control or during the cooking process.

Setting keep warm

See example below to set keep warm for the upper oven to start immediately with the auto-suggest (default) setting.

Example	
Step	Press
1. Press UPPER OVEN	UPPER OVEN
2. Press KEEP WARM	
3. Press START/enter	

To add or change any cook settings after this feature has started:

- Wake control panel from the sleep mode if necessary.
- Select the **UPPER** or **LOWER** oven you wish to change. Make temperature changes using the + or - keys. Each press of + or - will adjust the temperature by 5° F (or 2°C).
- If changing cooking times, select the **cook time** or **end time** keys needed to make the changes.

About slow cook

The slow cook feature may be used to cook foods more slowly at lower oven temperatures. The cooking results will be like that of a Slow Cooker or Crock-Pot. This feature is ideal for roasting beef, pork & poultry. Slow cooking meats may result in the exterior of meats becoming dark but not burnt; this is normal. Slow cook may be set in the upper or lower oven.

Slow cook may be set with the following options:

- Cook time
- Cook time with end time
- Probe

The following temperature settings apply to the slow cook feature:

- Hi: 275°F / 134°C (default) for cooking 4 to 5 hours
- Lo: 225°F / 108°C for cooking 8 to 9 hours



For best results

- Completely thaw all frozen foods before cooking.
- When using a single oven rack, place in position 2 or 3.
- Position multiple racks to accommodate size of cooking utensils when cooking multiple food item.
- Add any cream or cheese sauces during the last hour of cooking.
- Do not open the oven door often or leave the door open when checking foods. The more heat that is lost, the longer the food will need to cook.
- Cover the foods to keep them moist or use a loose or vented type cover to allow foods to turn crisp or brown.
- Roasts may be left uncovered so browning can occur. Cook times will vary depending on the weight, fat content, bone & the shape of the roast.
- Use the probe to check the temperature to determine when your food is done.
- Preheating the oven will not be necessary.

Setting slow cook

See the example below to set a slow cook on Lo.

Example	
Step	Press
1. Press UPPER OVEN*	UPPER OVEN
2. Press SLOW COOK	
3. Press -lo to choose the Lo option -Fig. 2.	- lo
4. Press START/enter	

*Choose the lower oven to use slow cook in the lower oven.



Fig.1



Fig. 2

NOTE

You may press CANCEL any time when setting the control or during the cooking process.

To add or change any cook settings after this feature has started:

- Wake control panel from the sleep mode if necessary.
- Select the **UPPER** or **LOWER** oven you wish to change. Make temperature changes using the + or - keys. Each press of + or - will adjust the temperature by 5° F (or 2°C).
- If changing cooking times, select the **cook time** or **end time** keys needed to make the changes.

About Perfect Turkey™

Heated air circulates around the turkey from all sides, sealing in juices and flavors. Poultry cooked with this feature are crispy brown on the outside while staying moist on the inside.

Perfect turkey combines a cook cycle with the convection fan. The probe is used to monitor the exact internal temperature of the turkey while cooking. Once the turkey has reached the set temperature, the oven will stop cooking and change to keep warm.



Before setting the perfect turkey feature, or if you would like to change the probe target temperature, be sure to carefully read and follow **setting the probe** instructions -See steps 6-9, p. 29.

NOTE

- You may press CANCEL any time when setting the control or during the cooking process.
- Any time during the cooking process you may press PROBE once to see the internal meat temperature reported by the probe. Press PROBE twice to review the probe set temperature.
- It is not recommended to modify the perfect turkey settings once cooking has started. Doing so may not provide the best results.

About Perfect Turkey™

See the example below to use perfect turkey at the default setting of 325°F and the probe at the default setting of 180°F (82°C).

Example	
Step	Press
1. Insert the probe into the thickest part of the meat and place the turkey in the oven -p. 28 Fig 1.	
2. Plug the probe into the probe receptacle inside the upper oven.	
3. Press UPPER OVEN	UPPER OVEN
4. Press PERFECT TURKEY Probe indicator will flash and Perfect Turkey will not start until the probe has been plugged in.	
5. Press START/enter	

Perfect Turkey Chart

Meat	Weight	Oven temp	Internal temp	Minute per lb.	
Poultry	Turkey, whole*	12 to 16 lbs.	325°F	180°F	8-10
	Turkey, whole*	16 to 20 lbs.	325°F	180°F	10-15
	Turkey, whole*	20 to 24 lbs.	325°F	180°F	12-16
	Chicken	3 to 4 lbs.	350°F -375°F	180°F	12-16

* Stuffed turkey requires additional roasting time. Shield legs and breast with foil to prevent overbrowning and drying of the skin.

About defrost



Use the defrost feature to thaw small portions of delicate items such as cream cakes, frozen cream pies and cheesecake at room temperature. The Defrost feature can only be used in the upper oven. While in the defrost mode, the convection fan will operate to circulate room temperature air around the food slowly, accelerating the natural defrosting of the food without using heat.

Defrost may be set with the following options:

- Cook time
- Cook time with end time

Setting defrost

See the example below to set defrost.

Example	
Step	Press
1. Place food in oven and press UPPER OVEN	
2. Press DEFROST	
3. Press START/enter	

NOTE

- You may press CANCEL any time when setting the control or during the cooking process.
- This feature is not meant for thawing frozen meats, poultry, seafood or other foods that need to be cooked before serving. Follow USDA recommendations for thawing foods. Only frozen foods that can be defrosted and served without cooking should be used with this feature.

About dehydrate



The dehydrate feature dries with heat from the convection element. The heat is circulated throughout the oven by the convection fan. Use dehydrate to dry and/or preserve foods such as fruits, vegetables, herbs and very thin slices of meat. Dehydrate may be set in the upper oven only. The Convection fan may operate while dehydrating.

The following temperature settings apply to the dehydrate feature:

- Auto-suggest (default) setting: **120°F / 48°C**
- Min. dehydrate setting: **100°F / 38°C**
- Max. dehydrate setting: **225°F / 108°C**

Setting dehydrate

See the example below to set dehydrate at the default temperature of 120°F.

Example	
Step	Press
1. Press UPPER OVEN	
2. Press DEHYDRATE	
3. Press START/enter	

To add or change any cook settings after this feature has started:

- Wake control panel from the sleep mode if necessary.
- Select the **UPPER** or **LOWER** oven you wish to change. Make temperature changes using the + or - keys. Each press of + or - will adjust the temperature by 5° F (or 2°C).
- If changing cooking times, select the **cook time** or **end time** keys needed to make the changes.

Setting dehydrate



For best results

- Dry most fruits and vegetables at 140°F. Dry herbs at 100°F.
- Drying times vary depending on the moisture and sugar content of the food, the size of the pieces, the amount being dried and the humidity in the air.
- Treat fruits with antioxidants to avoid discoloration.
- Tightly woven cooling racks can be used to allow the air to circulate around the food; or use drying racks to allow the air to circulate around the food (this type of oven rack is not supplied with this appliance).
- Consult a food preservation book or library for information.

About bread proof

The bread proof feature maintains a warm environment useful for rising yeast-leavened products. Bread proof may be set in the upper or oven only.

Bread proof may be set in conjunction with the following feature:

- My favorite

The following temperature settings apply to the bread proof feature:

- Auto-suggest (default) setting: **100°F/38°C**
- Min. bread proof setting: **85°F/30°C**
- Max. bread proof setting: **100°F / 38°C**



For best results

- Lightly cover the dough
- Place a bowl of hot water on the rack below.
- Use the oven light to check progress. Do not open the oven door.

Setting bread proof

See the example below to set bread proof for 85°F / 30°C).

Example	
Step	Press
1. Press UPPER OVEN	UPPER OVEN
3. Press BREAD PROOF	
4. Press and continue to press -lo to advance to 85°F	- lo
5. Press START/enter	



NOTE

You may press CANCEL any time when setting the control or during the cooking process.

To add or change any cook settings after this feature has started:

- Wake control panel from the sleep mode if necessary.
- Select the **UPPER** or **LOWER** oven you wish to change. Make temperature changes using the + or - keys. Each press of + or - will adjust the temperature by 5° F (or 2°C).
- If changing cooking times, select the **cook time** or **end time** keys needed to make the changes.



About my favorite

You may store up to 6 of your most frequently used heat settings and cooking times, three for each oven. These keys will light in the display when they are available for setting or recalling.

Each key will allow you to store a cooking feature, oven set temperature and a cook time for either the upper oven or lower oven.

Saving my favorite instructions



All the favorite keys will display after selecting the upper or lower oven. The example below shows how to save a favorite cooking instruction for the upper oven.

Example	
Step	Press
1. Press UPPER OVEN	UPPER OVEN
2. Input the cooking instructions using the control keypads and any additional options you wish to save and later recall.	
3. Press START	
4. Press and hold the available MY FAVORITE for 3 seconds	
5. Press CANCEL/off*	

You will hear a beep and a red light will display above the selected favorite to indicate that your favorite recipe has been stored.

*If you wish to store the cooking instructions but not start the oven.

Recalling a favorite

Example	
Step	Press
1. Press UPPER OVEN	UPPER OVEN
2. Choose MY FAVORITE	
3. Press START/enter	

Deleting/overwriting a favorite

Once all 3 favorites have been filled you may choose to overwrite an existing favorite. Follow the same instructions to save a recipe; choose the favorite you wish to overwrite and hold for 3 seconds.

It is not necessary to delete a favorite before saving another. Choose one of the favorite keys you no longer wish to keep and store the new cooking instructions using the overwriting instructions.

Perfect Program™ multi stage

Multi stage will allow you to program up to 3 stages of cooking. Each stage may be programmed with a cooking feature, set temperature and a cook time. Multi stage is ideal when you want to add a keep warm after a cooking function.

The following functions may be set with multi stage:

- Bake/conv bake
- Broil/conv broil (10 minutes max.)
- Conv roast
- Bread Proof
- Keep warm

Keep warm can be set from 150°F/66°C to 190°F/88°C. If you enter a temperature beyond this range your control will automatically default to the nearest temperature available.

6. Enter **60** minutes **60**

7. Press **START/enter** 

— Stage 2 —

8. Press **BROIL** 

9. Enter **500°F** **500**

10. Press **START/enter** 



11. Enter **4** minutes **4**

12. Press **START/enter twice**  

Setting multi stage









See the example to program a multi stage feature for a casserole. For stage 1, bake at 350°F for 1 hr. For stage 2, to brown, broil for at 500°F for 4 minutes.





Example for 2 stages

Step	Press
1. Press UPPER OVEN	UPPER OVEN
2. Press MULTI STAGE	1/3
— Stage 1 —	
3. Press BAKE	
4. Enter 350°F	350
5. Press START/enter	

Setting multi stage

See the example to program a multi stage feature for a casserole. For stage 1, bake at 350°F for 1 hr. For stage 2, to brown, broil for at 500°F for 4 minutes. For stage 3, keep warm at 170°F for 15 minutes.

Example	
Step	Press
1. Press UPPER OVEN	
2. Press MULTI STAGE	
<hr/> <i>Stage 1</i>	
3. Press BAKE	
4. Enter 350°F	350
5. Press START/enter	
6. Enter 60 minutes	60
7. Press START/enter	
<hr/> <i>Stage 2</i>	
8. Press BROIL	
9. Enter 500°F	500
10. Press START/enter	
11. Enter 4 minutes	4
12. Press START/enter	

<hr/> <i>Stage 3</i>	
13. Press KEEP WARM	
14. Enter 170°F	170
15. Press START/enter	
16. Enter 15 minutes	15
17. Press START/enter a total of 2 times to start cooking immediately.	 

Sabbath mode

This appliance provides special settings for use when observing the Jewish Sabbath/Holidays. This mode will turn off all audible tones or visual display changes normally provided by the oven control. **BAKE** and **cooktop** heating are the only cooking features available while in the Sabbath mode.

You must first set the **BAKE** feature and temperature(s) needed for the upper/lower oven(s), the **COOK TIME** option if needed and any cooktop power levels before setting the Sabbath mode. Any settings made prior to setting the Sabbath mode will be visible in the displays. The **COOK TIME** option, if set prior to the Sabbath mode, will give 1 audible alert at the end of **COOK TIME**.

The Sabbath mode will override the factory preset 12 Hour Energy Saving mode and the appliance will stay on until the cooking features are cancelled. If any of the cooking features are cancelled when the appliance is in the Sabbath mode, no audible or visual indicators will be available to verify the cancellation.

If the oven interior lights are needed, be sure to activate them prior to setting the Sabbath mode. Once the oven light is turned ON and the Sabbath mode is active, the oven light will remain on until the Sabbath mode is turned off and the oven lights are turned off. The oven door will not activate the oven interior lights when the oven door is opened or closed.

It is recommended that any oven temperature change with the Sabbath mode be followed with 2 presses of the **START** key. This will insure the oven remains ON even if the attempt to set the oven temperature was lower or higher than the oven control can accept. If the oven temperature is set incorrectly, the oven temperature will default to 170°F or 550°F. Try to set the desired oven temperature again.

The cooktop settings may also be changed even after the appliance has been set for the Sabbath mode (Jewish Holidays only).

Should a power failure or interruption occur during the Sabbath/Holidays, the appliance will shut OFF. When power is restored the appliance will not turn back on automatically to the original BAKE feature settings. **SF** will appear in the control display panel indicating a Sabbath mode failure - *Fig. 1*.

After a power failure, the food may be safely removed from the oven while still in the Sabbath mode.



Fig. 1



For further assistance, guidelines for proper usage and a complete list of models with the Sabbath feature, please visit the web at <http://www.star-k.org>.

Setting Sabbath mode

The example below shows setting the oven to observe the Sabbath (and Jewish holidays).

Example	
Step	Press
1. Press UPPER or LOWER OVEN	UPPER OVEN or LOWER OVEN
3. Press BAKE .	
Be sure to make any additional oven or cooktop setting changes before going to step 3.	
3. To enter Sabbath mode, press and hold both the LO and HI keys together for 3 seconds (a beep will sound) and release:	- & + lo & hi

Once properly set in Sabbath mode, *SAb* -Fig. 1- will show in the oven display until the Sabbath mode is cancelled.





Fig. 1

Canceling Sabbath mode

The example below shows how to cancel the Sabbath mode.

Example	
Step	Press
1. Press and hold both the LO and HI keys together for 3 seconds (a beep will sound) and release:	- & + lo & hi
2. All cooking features previously set and the cooktop will automatically cancel once Sabbath mode has ended.	

NOTES

The only keys available once the appliance is set for the Sabbath mode are the ⁺hi, ⁻lo, ,  & .

You may change the oven temperature and any cooktop settings once baking has started (Jewish holidays only). Choose oven and press **BAKE**, enter the oven temperature change (170 to 550F°) and press **START**. Remember that **the oven control will no longer beep or display any further changes** once the oven is set in the Sabbath mode.

Perfect Pair™ lower oven features

The lower oven provides two basic modes, cooking and warming. The lower oven is ideal for cooking foods such as pizza, casseroles, baked potatoes and frozen convenience foods. Use the keep warm feature to keep hot cooked foods at serving temperature.

These features are available for the lower oven:

- Bake
- Slow cook -p. 32
- Keep warm

WARNING

- **KEEP CHILDREN AWAY FROM THE LOWER OVEN WHEN HOT. FAILURE TO DO SO CAN RESULT IN BURNS.**

Recommendations for lower oven

- When placing food in the lower oven always use a baking sheet or pan with 4 raised sides to prevent food from sliding off.
- **DO NOT LINE THE OVEN DRAWER WITH FOIL OR COVER THE OVEN RACK WITH FOIL.** This may result in damage to your oven.
- The maximum height of foods and utensils that may be used in the lower oven is 2 1/2". The maximum width is 16". **Pay close attention to foods that have potential to rise beyond the recommended 2 1/2" maximum height.**
- Use pans in the lower oven large enough to contain food and any juices created from the cooking process.
- **Do not use plastic wrap to cover food. Plastic may melt onto the drawer or surrounding areas and be very difficult to clean.** Use a lid or aluminum foil instead. Use only utensils and cookware in the oven drawer that are recommended for oven use in the upper oven.

CAUTION

- Always use oven mitts when removing food from the lower oven. The lower oven rack, compartment, cookware/plates may be hot.
- Should an oven fire occur, close the drawer and turn the lower oven OFF. If the fire continues, use a fire extinguisher. **Do not** put water or flour on the fire. Flour may be explosive.



For best results

- The lower oven rack **must always be in place when cooking or warming.** Be sure that the rack is placed with the down turned sides into the drawer -Fig. 1. This will provide for some air space between the drawer and the food.
- For best results with the lower oven, pastries, casseroles with crumb toppings and bakery type items should be cooked in the upper oven.
- When using the lower oven, limit the number of times the drawer is opened; this will minimize heat loss. Repeated opening of the drawer during the cooking process may increase cooking times and produce uneven cooking results. The cooking times for the lower oven may vary slightly from the upper oven.

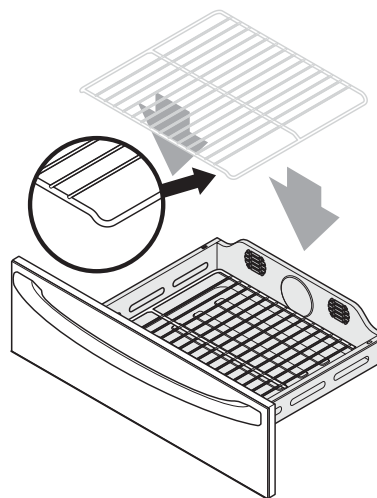

Fig. 1

About bake in the lower oven

Use the bake feature to cook food items with normal cooking temperatures.

Bake may be set with the following options:



- Cook time
- Cook time with end time

The following temperature settings apply to the bake feature:

- Auto-suggest (default) setting: **350°F/176°C**
- Min. bake setting: **170°F / 76°C**
- Max. bake setting: **450°F / 232°C**

Setting bake for lower oven

See example below to set a bake to start immediately using the default temperature.

Example	
Step	Press
1. Press LOWER OVEN	LOWER OVEN
2. Press BAKE	
3. Press START/enter	

Once **START** is pressed the lower oven will begin heating. The oven display shows **PRE-HEATING**.

After the lower oven reaches set temperature, **PRE-HEATING** will turn off and a beep will indicate the oven is ready. The oven will continue to maintain this temperature until the bake feature is canceled.

NOTE

You may press **CANCEL** any time when setting the control or during the cooking process.

About keep warm in the lower oven

Use the keep warm feature to keep cooked foods warm.

When using keep warm always start with hot food. Do not heat cold food.

Keep warm may be set with the following options:

- Cook time
- Cook time with end time

The following temperature settings apply to the keep warm feature:

- Auto-suggest (default) setting: **170°F/76°C**
- Min. keep warm setting: **150°F / 66°C**
- Max. keep warm setting: **190°F / 88°C**

If you enter a temperature beyond this range your control will automatically default to the nearest temperature available.

WARNING

- **FOOD POISONING HAZARD. Do not let food sit for more than one hour before or after cooking. Doing so can result in food poisoning or sickness.**

NOTE



- The lower oven will not operate when the upper oven is set for self-cleaning or the control lock feature is active.
- If the lower oven is ON and a self-clean or control lock request is attempted, the oven control will deny the request with a triple beep.

To add or change any cook settings after this feature has started:

- Wake control panel from the sleep mode if necessary.
- Select the **UPPER** or **LOWER** oven you wish to change. Make temperature changes using the **+** or **-** keys. Each press of **+** or **-** will adjust the temperature by 5° F (or 2°C).
- If changing cooking times, select the **cook time** or **end time** keys needed to make the changes.

Setting keep warm in the lower oven

See example below to set keep warm for the lower oven to start at 190°F/88°C:

Example	
Step	Press
1. Press LOWER OVEN	
2. Press KEEP WARM	
3. Use +hi to increase the temp. to 190°F.	+ hi
4. Press START/enter	

NOTE

- Use the **+hi** key to increase from the default keep warm temperature. Use the **-lo** to decrease the temperature.
- You may press CANCEL any time when setting the control or during the cooking process.

Lower oven cleaning tips

For easier clean-up, the lower oven should be cleaned as soon as the oven cools down. Clean after each use to minimize build-up of spatter and food leftovers. When cooking foods that spatter, cover the food with heat-proof lid or foil. Use a mild detergent and water to clean the oven drawer and sides. For stubborn soils use a non-abrasive cleaning pad to remove soils. **DO NOT** use oven cleaners on the oven cavity.

Temperature selection





See the recommended settings chart below for keep warm. If a particular food is not listed, use the default temperature of 170°F. If more crispness is desired, remove the lid or aluminum foil from the food. Most foods can be kept at serving temperatures at 170°F. When a combination of foods are to be kept warm (for example a meat with 2 vegetables and rolls) use 170°F.

Keep Warm Recommended Food Settings	
Food Item	Heating Level
Hot Beverages	190°F
Fried Foods	190°F
Vegetables	170°F
Soups (Cream)	170°F
Stews	170°F
Sauces	170°F
Meats	170°F
Gravies	150°F
Eggs	150°F
Dinner Plates with Food	150°F
Casseroles	150°F
Breads/Pasteries	150°F

About user preferences with Wave-Touch™

The  key controls options for preferences. The display will show a digital abbreviation and a value for every preference each time a key is pressed one at a time.

Please read the following instructions before changing the user preferences functions:



- Press and continue to press **USER PREF**  to navigate through the preferences.
- Press **+hi** or **-lo** to toggle between options for each preference.
- Press **+hi** or **-lo** to increase or decrease numeric values. You may also use the numeric keys to input precise values.
- Press **START**  to accept a new option entry or press **USER PREF**  to advance to the next preference.
- Press **CANCEL**  after pressing **START**  to exit the preferences mode.

NOTE

User preference options are not available while cooking or when using the kitchen timer.

Setting clock (CLO)

See the example below to set the clock to 1:30.

Example	
Step	Press
1. Press USER PREF.	
2. Enter 1:30 or use +hi/-lo to advance to 1:30.	130
3. Press START/enter to accept or press CANCEL/off to reject.	

Setting clock display (CLO)

The clock display mode allows you to turn the clock display on or off.

See the example below to change the clock display to OFF.



Example	
Step	Press
1. Press and continue to press USER PREF until you reach the pre-set clock display mode -Fig. 1-.	
2. Use the +hi & -lo to toggle to the CLO off option -Fig. 2-.	+ - hi or lo
3. Press START/enter to accept or press CANCEL/off to reject.	



Fig. 1

Fig. 2

Setting 12 or 24 hour mode

The clock display mode allows you to choose between 12 and 24 hour mode. The factory pre-set clock display mode is 12 hour.

See the example below to change the default mode to 24 hour.



Example	
Step	Press
1. Press and continue to press USER PREF until you reach the pre-set clock display mode -Fig. 1-	
2. Use the +hi & -lo to toggle to the 24hr option. -Fig. 2-	+ hi or - lo
3. Press START/enter to accept or press CANCEL/off to reject.	



Fig. 1

Changing between F° or C° (F-C)

Your control has the ability to display and set Fahrenheit or Celsius temperatures. The factory pre-set temperature display is Fahrenheit.

See the example below to change the default temperature display to Celsius.



Example	
Step	Press
1. Press and continue to press USER PREF until you reach the Fahrenheit/Celsius mode. -Fig. 1-	
2. Use the +hi or -lo to toggle to the C option. -Fig. 2-	+ hi or - lo
3. Press START/enter to accept or press CANCEL/off to reject.	



Fig. 1



Fig. 2

Setting 12hr energy saving mode (ES)

The oven control has a factory preset built-in 12 hour energy saving feature that will shut off the appliance if the oven has been heating for more than 11 hours and 59 minutes. The oven can be programmed to override this feature for continuous baking.

See the example below to turn off 12 hour energy saving mode.



Example	
Step	Press
1. Press and continue to press USER PREF until you reach the pre-set 12hr energy saving mode -Fig. 1.	
2. Use the +hi & -lo to toggle to the off option -Fig. 2.	+ hi or - lo
3. Press START/enter to accept or press CANCEL/off to reject.	



Fig. 1



Fig. 2

Setting audio mode (AUD)

The audio mode allows you choose between 5 levels of audio volume for the oven control. You may turn the audio off and later return to operating with all the normal audible sounds and alerts. The preheat and cook time features will still beep to alert you when to put your food in and take it out.

The factory pre-set audible level is 5.

See the example below when changing the audible level settings.



Example	
Step	Press
1. Press and continue to press USER PREF until you reach the pre-set AUD mode.	
2. Use the +hi or -lo to choose desired audio level -Fig. 1 or to choose the off option -Fig. 2.	+ hi or - lo
3. Press START/enter to accept or press CANCEL/off to reject.	



Fig. 1



Fig. 2



Adjusting oven temperature User programmable offset (UPO)

Your appliance has been factory calibrated and tested to ensure an accurate baking temperature. For the first few uses, follow your recipe times and temperature recommendations carefully.

If you feel your oven is too hot or too cool from your baking experience, the oven temperature may be adjusted to your liking. The temperature may be increased up to +35°F (+19°C) or decreased down to -35°F (-19°C) from normal.

See the example below to decrease the temperature in the **upper oven**.

Example	
Step	Press

1. Press and continue to press **USER PREF** until you reach the pre-set **UPO** mode *-Fig. 1.* 
2. Press **-lo** to adjust the temperature lower. **- lo**
3. Use **-lo** to advance to -10 *-Fig. 2.* **- lo**
4. Press **START/enter** to accept or press **CANCEL/off** to reject. 

To set the temperature higher use the **hi+** key.

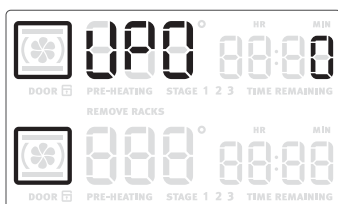

Fig. 1

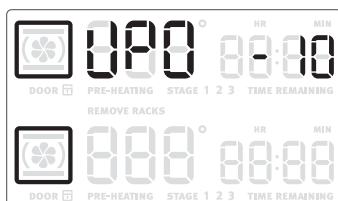



Fig. 2

Adjusting lower oven temperature (UPO)

The temperature may be increased +35°F (+19°C) or decreased -35°F (-19°C) from normal.

See the example below to increase the temperature in the **lower oven**.

Example	
Step	Press

1. Press and continue to press **USER PREF** until you reach the pre-set **UPO** mode. *-Fig. 1 -* 
 2. Press **+hi** to adjust the temperature higher. *-Fig. 2-* **+ hi**
 3. Use **+hi** to advance to 10. *-Fig. 2-* **+ hi**
 4. Press **START/enter** to accept or press **CANCEL/off** to reject. 
- To set the temperature lower use the lo- key.

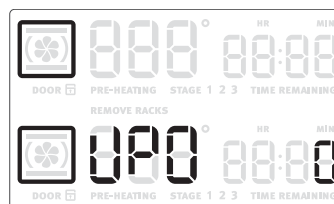

Fig. 1

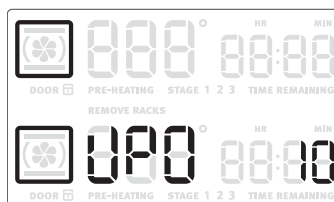

Fig. 2

Factory default reset (RST)

You may choose to restore your factory settings. **This will erase all settings or favorites that you have saved.**

See the example below reset your control.

Example	
Step	Press
1. Press and continue to press USER PREF until you reach the factory default reset mode <i>-Fig. 1.</i>	
2. Use the +hi or -lo to toggle to the yes option to reset <i>-Fig. 1.</i>	+ - hi or lo
3. Press CANCEL/off if you decide not to reset.	



Fig. 1



Fig. 2

User preferences chart

The following chart will help you navigate through the user preferences.

User Preferences Options		
Preference	1st option	2nd option*
Setting clock		
Clock display		
12 or 24 hour mode		
F° or C°		
12hr energy save mode		
Audio mode*		
UPO upper oven		
UPO lower oven		
Reset to factory pre-sets		

* Audio mode provides 6 possible settings

Before starting self-clean

A self-cleaning oven automatically cleans with high temperatures that are well above those used for normal cooking. The self-clean feature eliminates soils completely or reduces them to a fine powdered ash that you can later easily wipe away with a damp cloth.

Adhere to the following precautions when running the self-clean cycle:

- **Do not** use oven cleaners or protective coatings in or around the oven interior.
- **Do not** clean the oven door gasket. The woven material of the oven door gasket is essential for a good seal. Care should be taken not to rub, damage or remove the gasket -*Fig. 1*.
- **Do not** use any cleaning materials on the door gasket. Leaving chemical residue can damage the door gasket.
- **DO NOT** force the oven door open. The automatic door locking system can be damaged.
- **Remove** the broiler pan, insert, all utensils and any **aluminum foil**. These items cannot withstand high cleaning temperatures.
- All oven racks **MUST** be removed. If they are left in while attempting to set a self-clean cycle, the display will show **REMOVE RACKS** -*Fig. 2*. The oven control will not start a self-clean cycle without first removing all the oven racks.
- **Remove any excessive spillovers** in the oven cavity **before** starting a self-clean cycle. To clean, use hot, soapy water and a cloth. Large spillovers can cause heavy smoke or fire when subjected to high temperatures.
- Clean any soil from the oven frame, the door liner outside the oven door gasket and the small area at the front center of the oven bottom with soap and water. These areas heat sufficiently to burn soil on.
- **Do not** allow food spills with a high sugar or acid content (such as milk, tomatoes, sauerkraut, fruit juices or pie filling) to remain on the porcelain surface, they may leave a dull spot even after cleaning.

WARNING

During the self-clean cycle, the outside of the appliance can become very hot to the touch. **Do not** leave small children unattended near the appliance.

CAUTION

- **DO NOT** line the oven walls, oven racks, bottom or any other part of the range with aluminum foil. Doing so will stop heat distribution, produce poor baking results and cause permanent damage to the oven interior (aluminum foil will melt to the interior surface of the oven).
- Use caution when opening the door after the self-clean cycle is finished. The oven may still be **VERY HOT**.
- The health of some birds is extremely sensitive to the fumes given off during the self-cleaning cycle of any range. Move birds to another well-ventilated room.

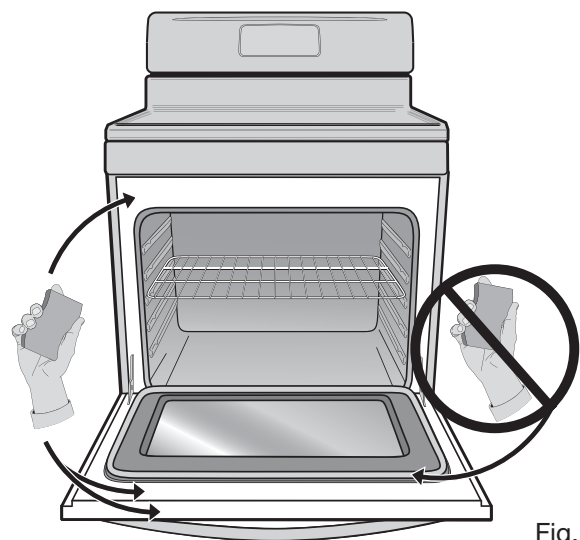



Fig. 1

REMOVE RACKS

Fig. 2

Setting self-clean

The clean feature provides 3 different choices for self-cleaning the upper oven. Set the clean for **lite** (2 hrs), **med** (3 hrs) or **heavy** soils (4 hrs). The example below shows setting the upper oven for self-clean to begin immediately using a medium (3 hour) setting.

Example	
Step	Press
1. Remove racks and Press UPPER OVEN	UPPER OVEN
2. Press CLEAN	
3. Select MED or select lite or heavy	med
4. Press START	

After pressing start, the motorized oven door latch will automatically lock the door. The DOOR lock icon will flash -Fig. 1. Once the door has locked the DOOR lock icon will remain on through the entire self-clean cycle.

After self-clean, the oven may take about 30-40 minutes to cool and unlock. A **Hot** message -Fig. 2- will display during this period. After cooling the DOOR lock icon will flash and disappear indicating that the door has unlocked.

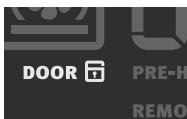

Fig. 1







Fig. 2

Setting delayed self-clean

You may wish to set your appliance to perform a self-clean cycle sometime later (up to 12 hours later). The **END TIME** key will determine when the cleaning will stop.

You will need to set the **END TIME** out far enough to allow for the type of clean cycle you choose (2-3-4 hours). Remember to add 30-40 additional minutes for the oven to cool enough and the oven door to unlock.

The example below shows setting the upper oven for a lite (2 hour) self-clean cycle to end at 8:00 o'clock.

Example	
Step	Press
1. Remove racks and Press UPPER OVEN	UPPER OVEN
2. Press CLEAN	
3. Select LITE	lite
4. Press COOK OPTIONS	
5. Press END TIME	
6. Enter 800	800
7. Press START	

→ IMPORTANT

- If a self-clean cycle was started but did not finish due to a power failure, your oven may not be completely cleaned. After power has been restored and the oven door has unlocked, set for another self-clean if needed.

🗨️ NOTES

- You may press CANCEL any time during the cleaning process. After cancelling the self-clean cycle, do not attempt to open the oven door until the DOOR lock icon turns off.
- If you desire to set a delayed self-clean cycle to end in 12-24 hours, use the **USER PREF** key to set the 12hr energy saving mode (ES) to OFF and also set the clock mode (CLO) to 24 hr.

Cleaning Recommendations

Surface Type	Cleaning Recommendation
<ul style="list-style-type: none"> Aluminum (trim pieces) & vinyl 	Use hot, soapy water and a cloth. Dry with a clean cloth.
<ul style="list-style-type: none"> Painted and plastic control knobs Body parts, Painted decorative trim 	<p><i>For general cleaning</i>, use hot, soapy water and a cloth. <i>For more difficult soils and built-up grease</i>, apply a liquid detergent directly onto the soil. Leave on soil for 30 to 60 minutes. Rinse with a damp cloth and dry. Do not use abrasive cleaners on any of these materials; they can scratch. To remove control knobs, turn to the OFF position; grasp firmly and pull straight off the shaft. To replace knobs after cleaning, line up the flat sides of both the knob and the shaft; then push the knob into place.</p>
<ul style="list-style-type: none"> Chrome control panel (some models) Decorative trim (some models) Stainless steel (some models) 	<p><i>Before cleaning the control panel</i>, turn all controls to OFF and remove the control knobs. To remove, pull each knob straight off the shaft. Clean using hot, soapy water and a dishcloth. Rinse with a clean water using a dishcloth. Be sure to squeeze excess water from the cloth before wiping the panel; especially when wiping around the controls. Excess water in or around the controls may cause damage to the appliance. To replace knobs after cleaning, line up the flat sides of both the knob and the shaft; then push the knob into place.</p> <p>Stainless steel (some models). Clean the stainless with warm soapy water using a clean sponge or cloth. Rinse with clean water and dry with a soft clean cloth. Do not use harsh scrubbing cleaners. Only use kitchen cleaners that are especially made for cleaning Stainless Steel. Always be sure to rinse the cleaners from the surface as bluish stains may occur during heating that cannot be removed.</p>
<ul style="list-style-type: none"> Porcelain enamel broiler pan and insert (if equipped) Door liner & body parts For Lower Oven cleaning instructions see the Lower Oven section. 	Gentle scouring with a soapy scouring pad will remove most spots. Rinse with a 1:1 solution of clear water and ammonia. <i>If necessary</i> , cover difficult spots with an ammonia-soaked paper towel for 30 to 40 minutes. Rinse with clean water and a damp cloth, and then scrub with a soap-filled scouring pad. Rinse and wipe dry with a clean cloth. Remove all cleaners or the porcelain may become damaged during future heating. Do not use spray oven cleaners on the cooktop.

Cleaning Recommendations

Surface Type	Cleaning Recommendation
<ul style="list-style-type: none"> • Oven racks 	<p>Oven racks must be removed. Clean by using a mild, abrasive cleaner following manufacturer's instructions. Rinse with clean water and dry.</p>
<ul style="list-style-type: none"> • Oven door 	<p>Use soap & water to thoroughly clean the top, sides and front of the oven door. Rinse well. You may use a glass cleaner on the outside glass of the oven door. Do not immerse the door in water. Do not spray or allow water or the glass cleaner to enter the door vents. Do not use oven cleaners, cleaning powders or any harsh abrasive cleaning materials on the outside of the oven door.</p> <p>Do not clean the oven door gasket. The oven door gasket is made of a woven material, on Self-Cleaning models, which is essential for a good seal. Care should be taken not to rub, damage or remove this gasket.</p>
<ul style="list-style-type: none"> • Burner heads, caps, grates & the cooktop 	<p>See "Cleaning cooktop and parts" in the Care and Cleaning section.</p>

Cleaning cooktop and parts

The cooktop is designed to make cleaning easier. Because the gas burners are sealed, cleanups are easy when spillovers are cleaned up immediately.

→ IMPORTANT

- **The cooktop is not removable.** Do not attempt to remove or lift the cooktop.
- **Do not allow spills, food, cleaning agents or any other material to enter the gas orifice port -Fig 1.**

Cooktop

If a spill occurs on or in the recessed or contoured areas, blot up spill with an absorbent cloth. Rinse with a clean, damp cloth and wipe dry. Do not use harsh abrasive cleaners on the cooktop. They can scratch the porcelain. Completely rinse any mild cleaners used from the surface or the porcelain cooktop may become damaged during future heating. **Do not** use spray oven cleaners on the cooktop.

Burner grates

The burner grates are dishwasher safe and may be cleaned in the dishwasher. Remove any excessive soils before placing in the dishwasher.

Before placing burner grates onto cooktop, turn grates over to identify rear of grate and place all the grates to the rear of the cooktop.

Burner heads & caps

⚠ CAUTION

Do not remove any parts from the cooktop until they have completely cooled and are safe to handle. Do not operate the surface burners without the burner caps.

To clean:

The ports (or slots) around the burner heads must be routinely cleaned. If residue still remains in these ports, use a small-gauge wire or needle to clean the slots or holes. For proper flow of gas and ignition of the burner — **Always** keep the burner caps in place whenever the gas burners are in use.

Your range is shipped with the burner heads and burner caps in the correct locations. Before using your gas range make sure to:

- Follow the installation instructions before installing.
- Remove all packing tape from cooktop area.

To remove:

Should you ever need to remove the burner cap for cleaning, simply lift the cap off the burner head.

To replace:

1. Pair up burner caps sizes with corresponding burner heads.
2. Align burner cap ignition area to the burner head ignition area. See illustration.
3. Place the burner cap vane slots onto the burner head vanes.

Before using make sure the burner cap fits flush with the burner head.

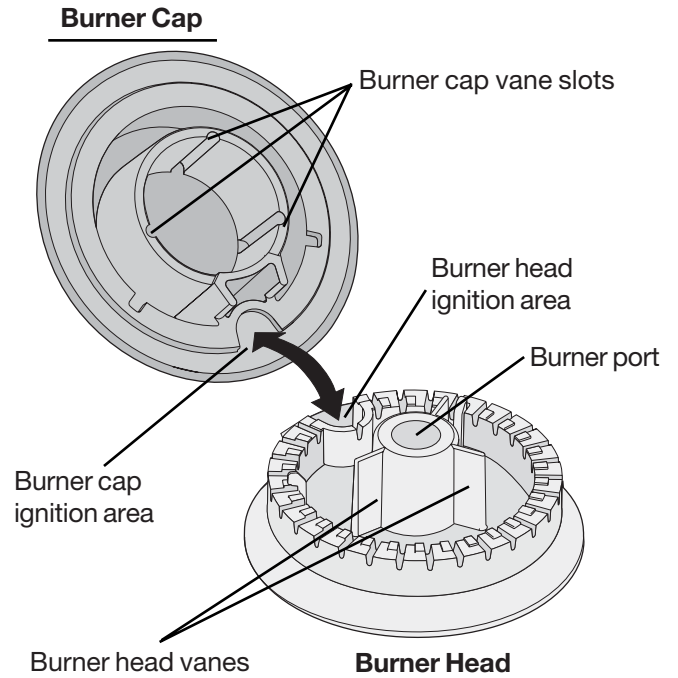

Fig. 1

Double ring burner heads & caps

The glass in the double ring burner is designed to fit loosely. Clean with normal non-abrasive glass cleaners and thoroughly dry before replacing.

The oven door with Luxury-Hold™ hinges

Removing the Lift-Off oven door

CAUTION

To prevent possible burns, do not attempt to remove the oven door until the oven has completely cooled.

IMPORTANT

The oven door is heavy. Be careful when removing and lifting the door. Do not lift the oven door by the handle.

1. Fully open the oven door -*Fig. 1*.
2. Unlock both oven door hinge locks by pulling them up and away from the oven frame until they stop (unlocked position) -*Figs. 2*. If needed use a small flat-bladed screwdriver to assist with loosening the door hinge locks.
3. Firmly grasp both sides of oven door -*Fig. 3*.
4. Before completing this step, be prepared to hold the whole weight of the door while grasping the sides of the oven door with both hands. Hold midway down the oven door sides. Close the oven door to about 4 inches and continue closing beyond the door stop position. The oven door should release from the frame on its own -*Fig. 3*.
5. Carefully lift door away evenly, slightly up and out until both hinge arms are clear of the hinge slots in the oven frame -*Fig. 3*. After door has been removed, be sure to lay the door flat with the inside of the door downward (never rest the oven door with any weight on the door handle).

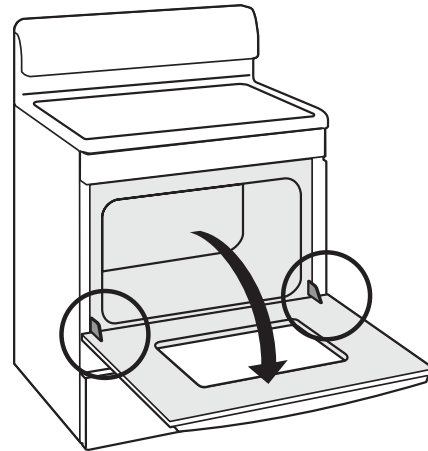

Fig. 1

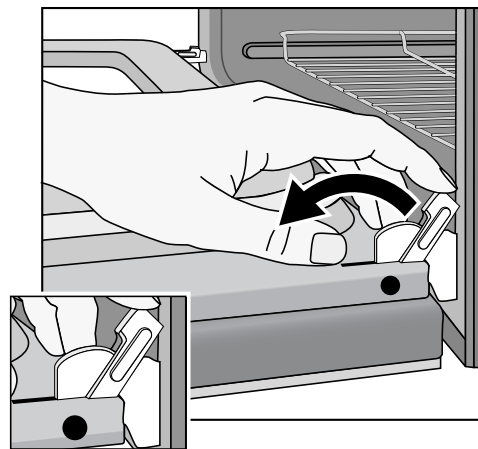

Fig. 2



Fig. 3

The oven door with Luxury-Hold™ hinges

To replace the Lift-Off oven door

1. Firmly grasp the oven door along both sides just below the door handle. When positioning the door hinge arms with the door hinge slots in the oven frame, you may wish to use your knee to stabilize the door before attempting to insert the door hinge arms in the hinge slots -*Fig. 1*.
2. Position the angle of the door to the door removal angle and carefully insert the door hinge arms fully and evenly into the door hinge slots. Carefully let the weight of the door transfer from your hands so that the oven now supports the oven door.
3. Open the oven door down to the fully open position -*Fig. 2*.
4. With the door in the fully open position, push both oven door hinge locks toward the oven frame until they both are locked -*Fig. 3*.
5. Close the oven door.



Fig. 1

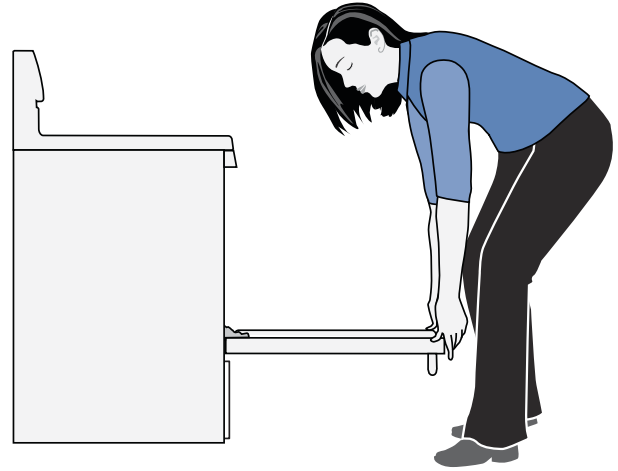

Fig. 2

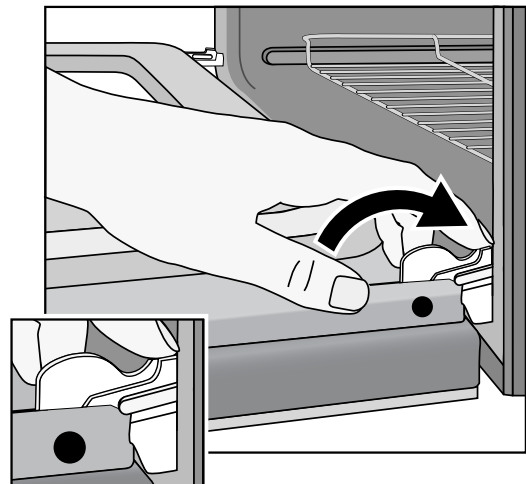

Fig. 3

Special door care instructions

➔ IMPORTANT

Most oven doors contain glass that can break. Read the following recommendations:

- **Do not** close the oven door until all the interior oven racks are fully inserted and retracted to the back of the oven.
- Do not hit the glass with pots, pans, or any other object. The oven door glass may break or even break at a later time unexpectedly.
- Scratching, hitting, jarring or stressing the oven door glass may weaken its structure causing an increased risk of breakage at a later time.
- You may use a glass cleaner on the outside of the oven door glass. **Do not spray** or allow water or the cleaner to enter or drip down into the oven door vents. Spray cleaner on cloth first and then wipe the oven door clean.
- **Do not** use strong oven cleaners, powders or any harsh abrasive cleaning materials on the outside of the oven door or glass.
- **Never clean** the oven door gasket. The oven door gasket should always clean during the Self-clean cycle.

Changing upper oven lights

⚠ CAUTION

- Be sure the range is unplugged and all parts are **COOL** before replacing oven light. Wear a leather-faced glove for protection against possible broken glass or burns.

The upper oven light bulbs are located at the rear of the oven cavity and both are covered with a glass shield. The glass shield must be in place whenever the oven is in use.

Replacing the upper oven interior light bulbs:

1. Turn electrical power off at the main source or unplug the range.
2. Remove upper oven interior light shield as illustrated below.
3. Replace bulb with a new **T-4 type 40 Watt Halogen** appliance bulb. Please note: do not allow your fingers to touch the new bulb when replacing. This will shorten the life of the new bulb. Use a paper towel to cover the new bulb when installing.
4. Replace glass shield over bulb.
5. Turn power back on again at the main source (or plug the range back in).
6. The clock will then need to be reset.

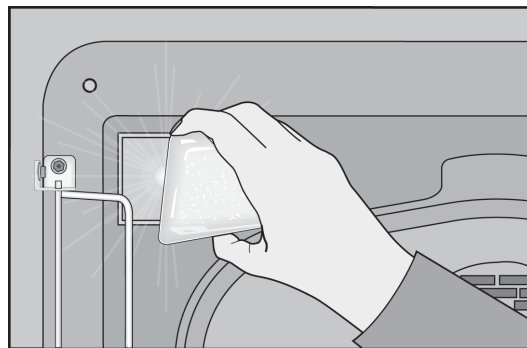

1. Before drawer removal, be sure to turn OFF the lower oven and let the drawer area cool completely.
2. Pull the drawer away from the oven. Using a phillips-head screwdriver remove the two drawer screws from the insides of the front oven drawer compartment -*Fig. 1*.
3. With one hand hold the drawer front in place. Use your other hand to pull the glide away from the oven -*Fig. 2*- until the glide hook disengages -*Fig. 3*.
4. Repeat from step 3 above for the other side of the drawer.
5. With BOTH glide hooks disengaged, carefully lift the drawer up and away from the oven. Push both drawer glides into lower oven cavity.
6. Replace the lower oven light with a 40 Watt appliance light bulb -*Fig. 5*.

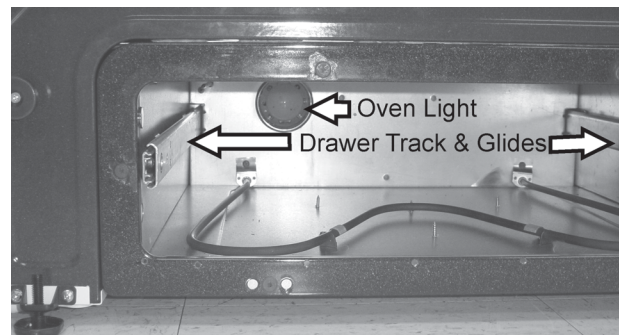
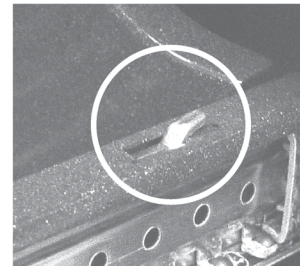
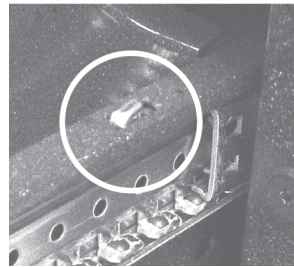
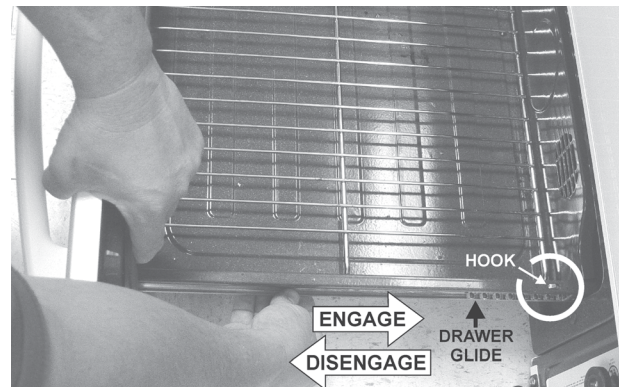
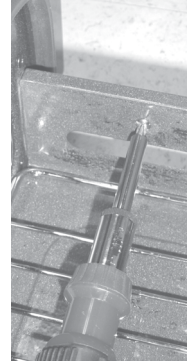

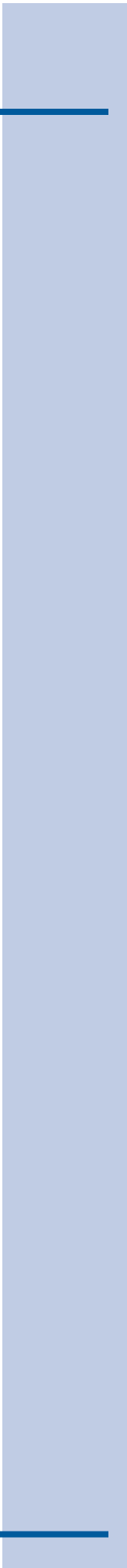
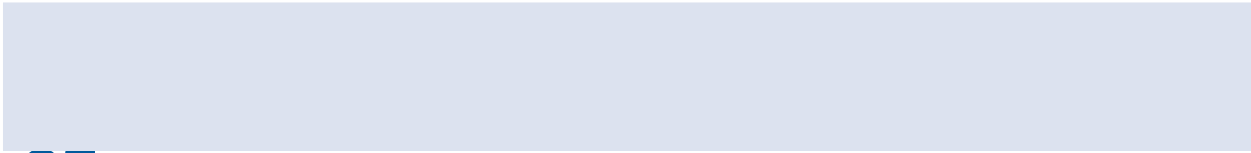

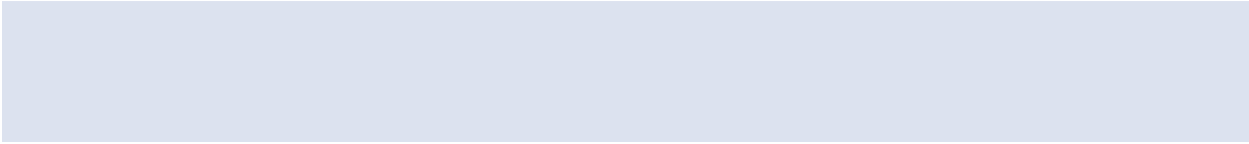
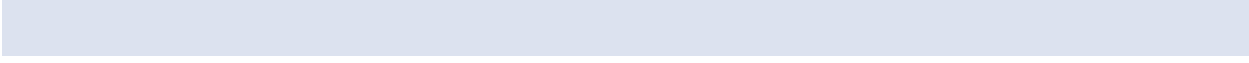
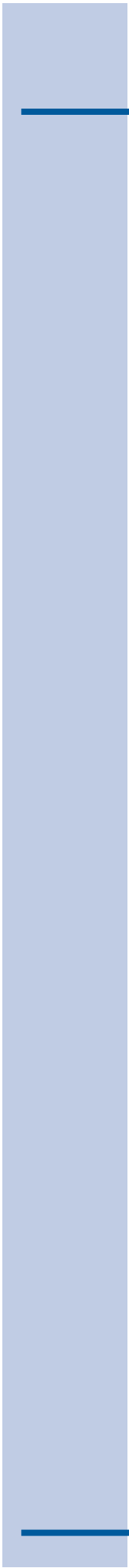

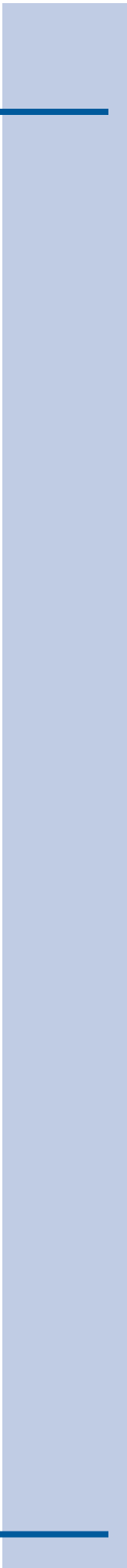
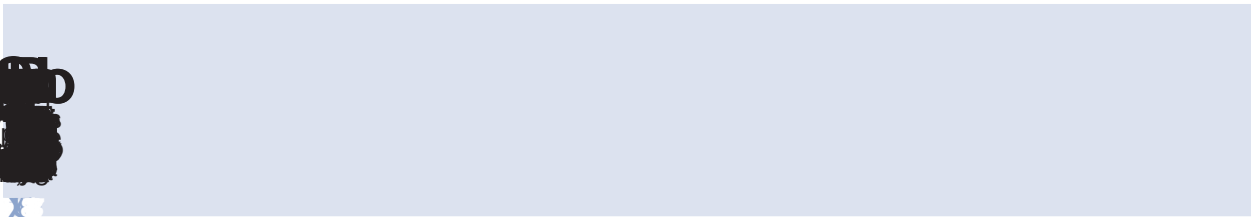
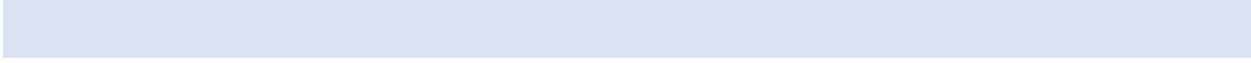



36

 **Electrolux**

