













Use & Care Manual

Dual Fuel Range

Welcome	2	
Important Safety Instructions	3-5	
Surface Cooking	6-7	
Setting Surface Controls	8-9	
Before Setting Oven Controls	10	
Setting Oven Controls	10	
Cooking Informations	11-13	
Adjusting Your Oven Temperature	13	
Setting Side Oven Controls	14	
Care & Cleaning	15-21	
Setting Oven Controls for Self-Clean Cycle	15	
Before You Call Solutions to Common Problems	22-23	
Warranty	Back Cover	

Visit the Frigidaire Web Site at:
<http://www.frigidaire.com>



Welcome & Congratulations

Questions?

1-800-944-9044

(United States)

1-866-294-9911

(Canada)

Please attach sales receipt here for future reference.

Congratulations on your purchase of a new appliance! At **Electrolux Home Products**, we are very proud of our product and are completely committed to providing you with the best service possible. Your satisfaction is our number one priority.

We know you'll enjoy your new appliance and **Thank You** for choosing our product. We hope you consider us for future purchases.

PLEASE CAREFULLY READ AND SAVE THESE INSTRUCTIONS

This Use & Care Manual contains general operating instructions for your appliance and feature information for several models. Your product **may not** have all the described features. The graphics shown are representative. The graphics on your appliance may not look exactly like those shown. These instructions are not meant to cover every possible condition and situation that may occur. Common sense and caution must be practiced when installing, operating and maintaining any appliance.

Please record your model and serial numbers below for future reference.

Model Number: _____

Serial Number: _____

Purchase Date: _____

Product Registration

Register Your Product

The **PRODUCT REGISTRATION CARD** should be filled in completely, signed and returned to Electrolux Home Products.

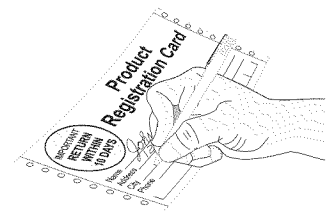

Serial Plate Location

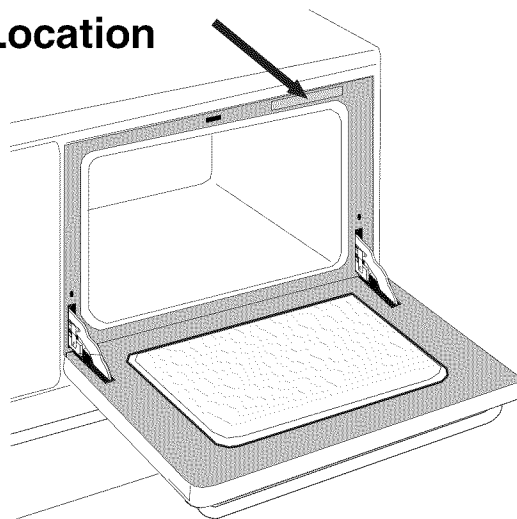

Versión en español

Si desea obtener una copia en español de este Manual del Usuario, sírvase escribir a la dirección que se incluye a continuación. Solicite la P/N 318200765E.

Spanish Use & Care Manual
Electrolux Home Products
P. O. Box 212378
Augusta, GA 30917

Important Safety Instructions



Read all instructions before using this appliance. Save these instructions for future reference.

This manual contains many important safety messages. Always read and obey all safety messages.

The safety symbol  calls your attention to safety messages that inform you of hazards that can kill or hurt you or others, or cause damage to the product.

⚠ WARNING Indicates an imminently hazardous situation which, if not avoided may result in death or serious injury.

⚠ CAUTION Indicates an imminently hazardous situation which, if not avoided may result in minor or moderate injury, or product damage.

All safety messages will identify the hazard, tell you how to reduce the chance of injury, and tell you what can happen if the instructions are not followed.

⚠ WARNING If the information in this manual is not followed exactly, a fire or explosion may result causing property damage, personal injury or death.

FOR YOUR SAFETY:

- Do not store or use gasoline or other flammable vapors and liquids in the vicinity of this or any other appliance.
- **WHAT TO DO IF YOU SMELL GAS:**
 - Do not try to light any appliance.
 - Do not touch any electrical switch; do not use any phone in your building.
 - Immediately call your gas supplier from a neighbor's phone. Follow the gas supplier's instructions.
 - If you cannot reach your gas supplier, call the fire department.
- Installation and service must be performed by a qualified installer, servicer or the gas supplier.



⚠ WARNING

- All ranges can tip.
- Injury to persons could result.
- Install anti-tip device packed with range.
- See Installation Instructions.



⚠ WARNING

To reduce the risk of tipping, the range must be secured by properly installed anti-tip bracket(s) provided with the range. To check if the bracket(s) is installed properly, remove the lower panel or storage drawer and verify that the anti-tip bracket(s) is engaged. Refer to the Installation Instructions for proper anti-tip bracket(s) installation.

- **Remove all tape and packaging before using the range.** Destroy the carton and plastic bags after unpacking the range. Never allow children to play with packaging material.
- **Proper Installation—Be sure your appliance is properly installed and grounded by a qualified technician in accordance with the National Fuel Gas Code ANSI Z223.1 latest edition, and National Electrical Code ANSI/NFPA No. 70—latest edition, and local code requirements.** Install only per installation instructions provided in the literature package for this range.

Ask your dealer to recommend a qualified technician and an authorized repair service. Know how to disconnect the power to the range at the circuit breaker or fuse box and gas supply at the main shutoff valve in case of an emergency. Remove the drawer to access the valve.

- **User servicing—Do not repair or replace any part of the appliance unless specifically recommended in the manuals.** All other servicing should be done only by a qualified technician, this may reduce the risk of personal injury and damage to the range.
- Never modify or alter the construction of a range by removing leveling legs, panels, wire covers, anti-tip brackets/screws, or any other part of the product.

⚠ WARNING Stepping, leaning or sitting on the doors or drawer of this range can result in serious injuries and also cause damage to the range. Do not allow children to climb or play around the range. The weight of a child on an open door may cause the range to tip, resulting in serious burns or other injury.

⚠ WARNING Do not use the oven for storage.

⚠ CAUTION Do not store items of interest to children in the cabinets above a range or on backguard of a range. Children climbing on the range to reach items could be seriously injured.

⚠ WARNING NEVER use this appliance as a space heater to heat or warm the room. Doing so may result in carbon monoxide poisoning and overheating of the oven.

- **Storage in or on Appliance—Flammable materials should not be stored in an oven, near surface burners or in the drawer (if equipped).** This includes paper, plastic and cloth items, such as cookbooks, plasticware and towels, as well as flammable liquids. Do not store explosives, such as aerosol cans, on or near the appliance. Flammable materials may explode and result in fire or property damage.



Important Safety Instructions

- **Do not leave children alone**—Children should not be left alone or unattended in the area where appliance is in use. They should never be allowed to sit or stand on any part of the appliance.
- **DO NOT TOUCH SURFACE BURNERS, AREAS NEAR THESE BURNERS, OVEN HEATING ELEMENTS OR INTERIOR SURFACES OF THE OVEN.** Both surface burners and oven heating elements may be hot even though they are dark in color. Areas near surface burners may become hot enough to cause burns. During and after use, do not touch, or let clothing or other flammable materials touch these areas until they have had sufficient time to cool. Among these areas are the cooktop, surfaces facing the cooktop, the oven vent openings and surfaces near these openings, oven door and window.
- **Wear proper apparel**—Loose-fitting or hanging garments should never be worn while using the appliance. Do not let clothing or other flammable materials contact hot surfaces.
- Do not use water or flour on grease fires—Smother the fire with a pan lid, or use baking soda, a dry chemical or foam-type extinguisher.
- **When heating fat or grease, watch it closely.** Fat or grease may catch fire if allowed to become too hot.

⚠ WARNING In case of fire or gas leak, be sure to turn off the main gas shutoff valve.

- **Use only dry potholders**—Moist or damp potholders on hot surfaces may result in burns from steam. Do not let potholders touch hot heating elements. Do not use a towel or other bulky cloth instead of a potholder.
- Do not heat unopened food containers—Build-up of pressure may cause container to burst and result in injury.
- Remove the oven doors from any unused range if it is to be stored or discarded.

IMPORTANT—Do not attempt to operate the oven during a power failure. If the power fails, always turn the ovens off. If the ovens are not turns off and the power resumes, the oven may begin to operate again. Food left unattended could catch fire or spoil.

⚠ WARNING Use proper pan size—Adjust flame size so it does not extend beyond the edge of the utensil. The use of undersize utensils will exposed a portion of the burner flame to direct contact and may result in ignition of clothing. Proper relationship of utensil to flame will also improve efficiency.

⚠ WARNING Do not use stove top grills on the burner grates of sealed gas burners. If you use a stove top grill on a sealed gas burner, it will cause incomplete combustion and can result in exposure to carbon monoxide levels above allowable current standards. This can be hazardous to your health.

⚠ CAUTION Electronic controllers can be damaged by cold temperatures. When you use your appliance for the first time, or if it has not been used for a long period of time, make sure that it has been exposed to a temperature above 0°C/32°F for at least 3 hours before connecting it to the power supply.

IMPORTANT INSTRUCTIONS FOR USING YOUR COOKTOP

- **Know which knob controls each surface heating unit.** Always turn the knob to the LITE position when igniting the burners. Visually check that burner has lit. Then adjust the flame so it does not extend beyond the edge of the utensil.
- **Use proper pan size.** This appliance is equipped with one or more surface burners of different sizes. Select utensils having flat bottoms large enough to cover the surface burner. The use of undersized utensils will expose a portion of the surface burner to direct contact and may result in ignition of clothing. Proper relationship of utensil to the surface burner will also improve efficiency.
- **Utensil handles should be turned inward and not extend over adjacent surface burners**—To reduce the risk of burns, ignition of flammable materials, and spillage due to unintentional contact with the utensil. The handle of the utensil should be positioned so that it is turned inward, and does not extend over adjacent surface burners.
- **Never leave surface burners unattended at high heat settings**—Boilovers cause smoking and greasy spillovers that may ignite, or a pan that has boiled dry may melt.
- **Protective liners**—Do not use aluminum foil to line oven bottom or any other part of the appliance. Only use aluminum foil as recommended for baking if used as a cover placed on the food. Any other use of protective liners or aluminum foil may result in a risk of electric shock or fire or short circuit.
- **Glazed cooking utensils**—Only certain types of glass, glass/ceramic, ceramic, earthenware, or other glazed utensils are suitable for rangetop service without breaking due to the sudden change in temperature. Check the manufacturer's recommendations for rangetop use.
- **Do not use decorative surface burner covers.** If a burner is accidentally turned on, the decorative cover will become hot and possibly melt. Burns will occur if the hot covers are touched. Damage may also be done to the cooktop or burners because the covers may cause overheating. Air will be blocked from the burner and cause combustion problems.

FOR GLASS COOKTOPS ONLY

- **Do not clean or operate a broken cooktop**—If cooktop should break, cleaning solutions and spillovers may penetrate the broken cooktop and create a risk of electric shock. Contact a qualified technician immediately.

Important Safety Instructions



- **Clean cooktop glass with caution**—If a wet sponge or cloth is used to wipe spills on a hot cooking area, be careful to avoid a steam burn. Some cleaners can produce harmful fumes if applied to a hot surface.
- Avoid scratching the cooktop glass with sharp objects.

IMPORTANT INSTRUCTIONS FOR USING YOUR OVEN

- **Use care when opening oven door**—Stand to the side of the range when opening the door of a hot oven. Let hot air or steam escape before you remove or replace food in the oven.
- **Keep ovens vents unobstructed.** Each vent has its own vent located on the top, near each side and towards the back of the cooktop. Touching the surfaces in this area when the oven is operating may cause severe burns. Also, do not place plastic or heat-sensitive items on or near an oven vent. These items could melt or ignite.

⚠ WARNING NEVER cover any slots, holes or passages in the oven bottom or cover an entire rack with materials such as aluminum foil. Doing so blocks air flow through the oven and may cause carbon monoxide poisoning. Aluminum foil linings may trap heat, causing a fire hazard.

- **Placement of ovens racks.** Always place oven racks in desired location while ovens are cool. If rack must be moved while oven is hot use extreme caution. Use potholders and grasp the rack with both hands to reposition. Do not let potholders contact the hot heating elements in the ovens. Remove all utensils from the rack before moving.
- **Do not use a broiler pan without its grid.** Broiler pan and its grid allow dripping fat to drain and be kept away from the high heat of the broiler.
- **Do not cover broiler grid with aluminum foil.** Exposed fat and grease could ignite.
- **Do not touch a hot light bulb with a damp cloth.** Doing so could cause the bulb to break. Disconnect the appliance or turn off the power to the appliance before removing and replacing light bulb.

IMPORTANT INSTRUCTIONS FOR CLEANING YOUR RANGE

- **Clean the range regularly to keep all parts free of grease that could catch fire.** Exhaust fan ventilation hoods and grease filters should be kept clean. Do not allow grease to accumulate on hood or filter. Greasy deposits in the fan could catch fire. When you are flaming food under the hood, turn the fan on. Refer to the hood manufacturer's instructions for cleaning.
- **Kitchen cleaners and aerosols**—Always follow the manufacturer's recommended directions for use. Be aware that excess residue from cleaners and aerosols may ignite causing damage and injury.

SELF CLEANING OVENS

- **In the self-Cleaning cycle only clean the parts listed in this Use and Care Guide.** Before self cleaning the oven, remove the all utensils or foods from the oven.
- **Do not use oven cleaners**—No commercial oven cleaner or ovens liner protective coating of any kind should be used in or around any part of the oven.
- **Do not clean door gasket**—The door gasket is essential for a good seal. Care should be taken not to rub, damage or move the gasket.
- **Remove oven racks.** Oven racks color will change if left in the oven during a self-cleaning cycle.

⚠ CAUTION The health of some birds is extremely sensitive to the fumes given off during the self-cleaning cycle of any range. Move birds to another well ventilated room.

IMPORTANT SAFETY NOTICE

The California Safe Drinking Water and Toxic Enforcement Act requires the Governor of California to publish a list of substances known to the state to cause cancer, birth defects or other reproductive harm, and requires businesses to warn customers of potential exposure to such substances.

SAVE THESE INSTRUCTIONS

Conversion to Liquefied Petroleum Gas (or L. P. Gas)

This natural gas range is designed to allow for conversion to Liquefied Petroleum (L. P.) Gas.

Only a qualified service agent should perform the L. P. conversion. Call an authorized servicer if you wish to have them perform the conversion. An L. P. Conversion Kit is provided with this range and is located on the main back of the range. The kit contains installation instructions which must be read before and followed carefully when installing the kit.

⚠ WARNING To avoid serious injury, any additions, changes or conversions required in order for this appliance to satisfactorily meet the application needs must be made by a qualified service agent.



Surface cooking

Use Proper Cookware

Cookware should have flat bottoms that make good contact with the entire surface heating element. Check for flatness by rotating a ruler across the bottom of the cookware (See Figure 1). Be sure to follow the recommendations for using cookware as shown in Figure 2.

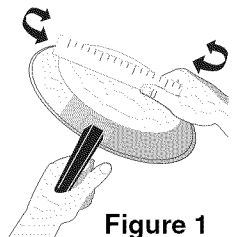
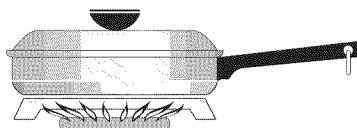

Figure 1

Note: The size and type of cookware used will influence the setting needed for best cooking results.

Note: Always use a utensil for its intended purpose. Follow manufacturer's instructions. Some utensils were not made to be used in the oven or on the cooktop.

CORRECT



- Flat bottom and straight sides.
- Tight fitting lids.
- Weight of handle does not tilt pan. Pan is well balanced.
- Pan sizes match the amount of food to be prepared.
- Made of material that conducts heat well.
- Easy to clean.

INCORRECT

- Curved and warped pan bottoms.

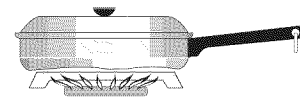

- Pan overhangs burner grate by more than 2.5 cm (1").

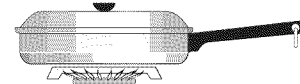

- Heavy handle tilts pan.

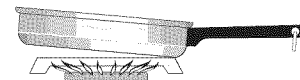

- Flame extends beyond pan.

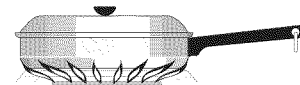

Figure 2

- * Specialty pans such as lobster pots, griddles and pressure cookers may be used but must conform to the above recommended cookware requirements.

Using a wok

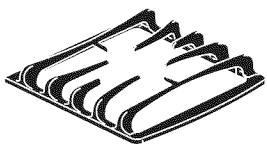
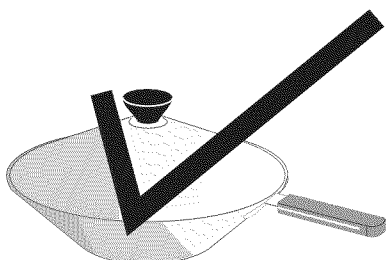

Figure 3

Woks with flat bottoms suitable for use on your cooktop are available in most cookshop or hardware stores. Round-bottomed woks (with a support ring that does not extend beyond the burner circumference) may also be used. The metal ring was designed to support the wok safely when it is filled with large amounts of liquids (soup making) or fat (frying).

Wire trivets: Do not use wire trivets. Cookware bottoms must be in direct contact with the grates.

DO NOT use a wok if it is equipped with a metal ring that extends beyond the burner circumference. Because this ring traps heat, the surface unit and cooktop surface could be damaged.

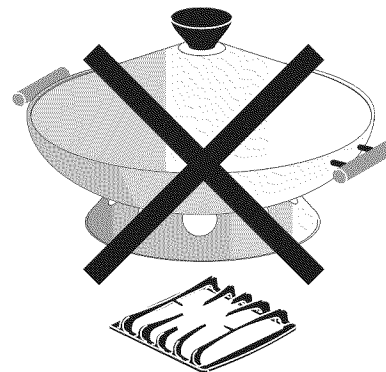

Figure 5

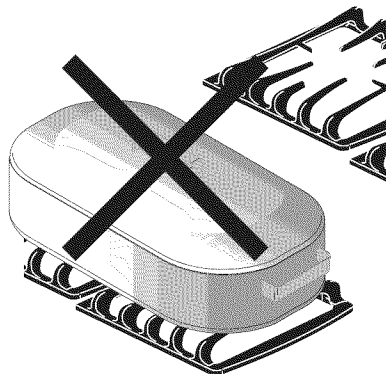

Figure 4

CAUTION DO NOT use two burner units to heat one large pan such as a roaster or griddle, or allow cooking utensils to boil dry. The bottom surface of the pan in either of these situations could cause discoloring or crazing of the appliance cooking surface, and damage to the grates and burner units.

Surface cooking



Canning Tips & Information

CAUTION Canning can generate large amounts of steam. Use extreme caution to prevent burns. Always raise the lid to vent steam away from you.

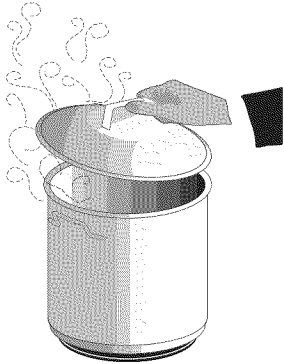

1. Use tested recipes and follow instructions carefully. Check with your local Cooperative Agricultural Extension Service or a manufacturer of glass jars for the latest canning information.
2. Use flat-bottomed canners only. Heat is spread more evenly when the bottom surface is flat.
3. Center canner on the burner grate.
4. Start with hot water and a high heat setting to reduce the time it takes to bring the water to a boil; then reduce the heat setting as low as possible to maintain a constant boil.
5. It is best to can small amounts and light loads.

CAUTION Prevent damage to cooktop and burner grates:

1. Do not use water bath or pressure canners that extend more than one inch beyond the edge of the burner grate.
2. Do not leave water bath or pressure canners on high heat for an extended amount of time.
3. Alternate surface units between each batch to allow the units and surrounding surfaces to cool down. Try to avoid canning on the same burner unit all day.

CAUTION Safe canning requires that harmful micro-organisms are destroyed and the jars are sealed completely. When canning in a water bath canner, a gentle but steady boil must be maintained continuously for the required time.



Setting Surface Controls

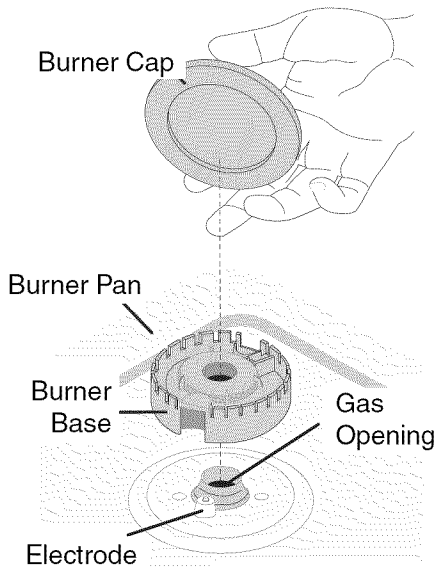

Placement of Burner Bases and Caps

Your Cooktop is equipped with three different sizes of burners: Power Burner, Standard Burner and Simmer Burner.

Place the burner base over each gas opening, matching the burner base size with the gas opening size. Place the burner cap on each burner base, again matching the cap size to the burner base size. The cap for each burner has an inner locating ring which locates the burner cap in the center of the burner.

Make sure each burner cap is properly aligned and level.

Turn the burner on to determine if it will light. If the burner does not light, contact a Service Center. Do not service the sealed burner yourself.

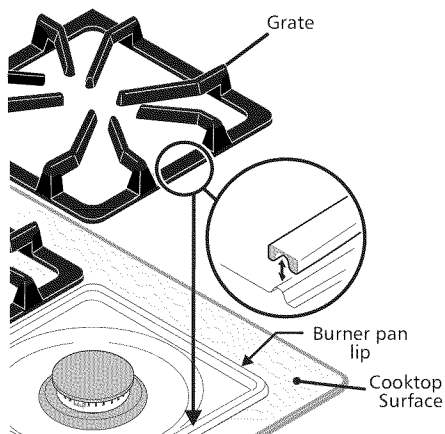

Placement of Burner Grates

Place grate over burner pans. Make sure that the groove under grate fits over the raised lip of the burner pan. The rounded corners of the grates should be placed toward the front of the cooktop for the front burners and the rear of the cooktop for the back burners.

Setting Surface Controls



⚠ CAUTION Do not place plastic items such as salt and pepper shakers, spoon holders or plastic wrappings on top of the range when it is in use.

These items could melt or ignite. Potholders, towels or wood spoons could catch fire if placed too close to a flame.

In the event of an electrical power outage, the surface burners can be lit manually. To light a surface burner, hold a lit match to the burner head, then slowly turn the surface control knob to **LITE**. After burner lights push in and turn knob to desired setting. Use caution when lighting surface burners manually.

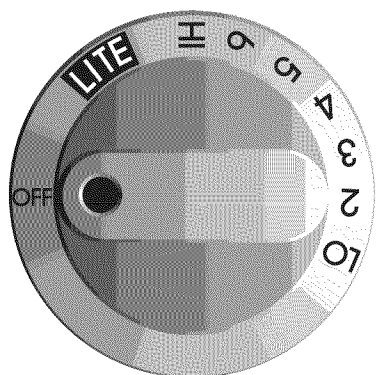

Figure 1

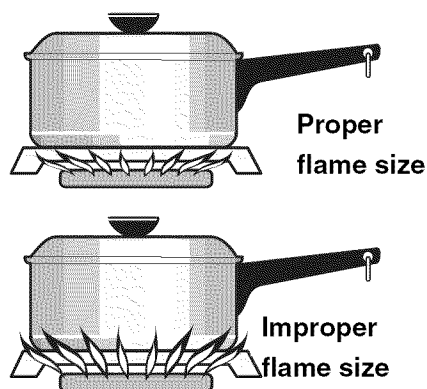

Figure 2

Operating the Gas Surface Controls:

1. Place cooking utensil on surface burner.
2. Push the surface control knob down and turn **counterclockwise** out of the OFF position (See Figure 1).
3. Release the knob and rotate to the LITE position. Note: All four electronic surface ignitors will spark at the same time. However, only the burner you are turning on will ignite.
4. Visually check that the burner has a flame.
5. Turn the control knob **counterclockwise** to the desired flame size. The control knobs do not have to be set at a particular setting. Use the knob indicator settings to adjust the flame as needed. **DO NOT** cook with the surface control knob in the LITE position. (The electronic ignitor will continue to spark if the knob is left in the LITE position.)

Setting Proper Surface Burner Flame Size

For most cooking, start on the highest control setting and then turn to a lower one to complete the process. Use the recommendations below as a guide for determining proper flame size for various types of cooking. The size and type of utensil used and the amount of food being cooked will influence the setting needed for cooking.

*Flame Size	Type of Cooking
High Flame	Start most foods; bring water to a boil; pan broiling.
Medium Flame	Maintain a slow boil; thicken sauces, gravies; steaming.
Low Flame	Keep foods cooking; poach; stewing.

***These settings are based on using medium-weight metal or aluminum pans with lids. Settings may vary when using other types of pans.** The color of the flame is the key to proper burner adjustment. A good flame is clear, blue and hardly visible in a well-lighted room. Each cone of flame should be steady and sharp. Clean burner if flame is yellow-orange.

Regardless of size, always select cookware that is suitable for the amount and type of food being prepared. Select a burner and flame size appropriate to the pan. Never allow flames to extend beyond the outer edge of the pan.

Never extend the flame beyond the outer edge of the utensil. A higher flame wastes heat and energy and increases your risk of being burned by the flame (Figure 2).

For deep fat frying, use a thermometer and adjust the surface control knob accordingly. If the fat is too cool, the food will absorb the fat and be greasy. If the fat is too hot, the food will brown so quickly that the center will be undercooked. Do not attempt to deep fat fry too much food at once as the food will neither brown nor cook properly.



Before Setting Oven Controls

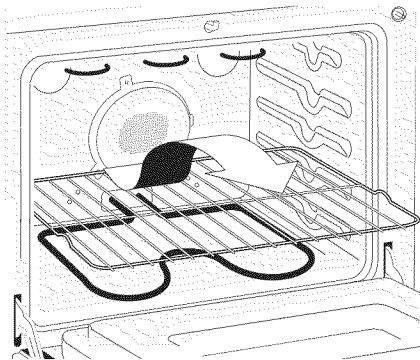

Main Oven

Oven Vent(s) and Racks

Ovens Vents Locations

Each oven has its own vent located on the top, near each side and towards the back of the cooktop. When an oven is on, warm air is released through the vent; this ventilation is necessary for proper air circulation in the oven and good baking results.

Arranging Oven Racks

The smaller oven has one oven rack and the larger oven has two oven racks. **ALWAYS ARRANGE OVEN RACKS WHEN THE OVEN IS COOL (PRIOR TO OPERATING THE OVEN).** Always use oven mitts when using the oven.

To remove an oven rack, pull the rack forward until it stops. Lift up front of rack and slide out.

To replace an oven rack, fit the rack onto the guides on the oven walls. Tilt the front of the rack upward and slide the rack back into place.

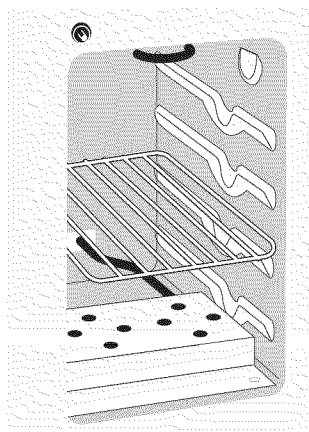

Side Oven

Air Circulation in the Oven

For best air circulation and baking results allow 2-4" (5-10 cm) around the cookware for proper air circulation and be sure pans and cookware do not touch each other, the oven door, sides or back of the oven cavity. The hot air must circulate around the pans and cookware in the oven for even heat to reach around the food.

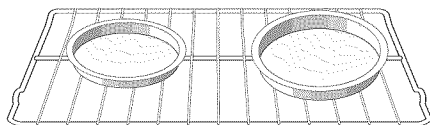

1 Oven Rack

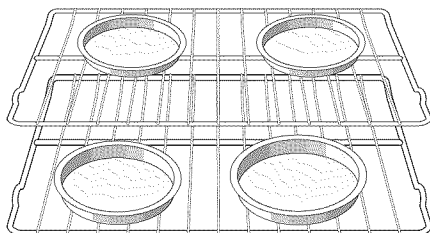

Multiple Oven Racks



Setting Oven Controls

Refer to the Electronic Oven Control Guide for oven settings.

Cooking Informations





Oven Baking

For best cooking results, heat the oven before baking cookies, breads, cakes, pies or pastries, etc... There is no need to preheat the oven for roasting meat or baking casseroles.

The cooking times and temperatures needed to bake a product may vary slightly from your previously owned appliance.

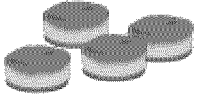
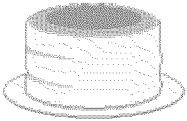
Baking Problems and Solutions Chart

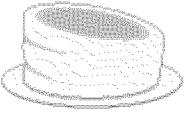
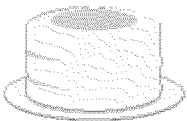
Baking Problems	Causes	Corrections
Cookies and biscuits burn on the bottom. 	<ul style="list-style-type: none"> • Cookies and biscuits put into the oven before the preheating time is completed. • Oven rack overcrowded. • Dark pan absorbs heat too fast. 	<ul style="list-style-type: none"> • Allow oven to preheat to the selected temperature before placing food in oven. • Choose pan sizes that will permit 5.1 cm to 10.2 cm (2" to 4") of air space on all sides when placed in the oven. • Use a medium-weight aluminum baking sheet.
Cakes too dark on top or bottom. 	<ul style="list-style-type: none"> • Cakes put into the oven before preheating time is completed. • Rack position too high or low. • Oven too hot. 	<ul style="list-style-type: none"> • Allow oven to preheat to the selected temperature before placing food in the oven. • Use proper rack position for baking needs. • Set oven temperature 25°F/12°C lower than recommended.
Cakes not done in the center. 	<ul style="list-style-type: none"> • Oven too hot. • Incorrect pan size. • Pan not centered in oven. 	<ul style="list-style-type: none"> • Set oven temperature 25°F/12°C lower than recommended. • Use pan size suggested in recipe. • Use proper rack position and place pan so there is 5.1 cm to 10.2 cm (2" to 4") of space on all sides of pan.
Cakes not level. 	<ul style="list-style-type: none"> • Range not level. • Pan too close to oven wall or rack overcrowded. • Pan warped. 	<ul style="list-style-type: none"> • Place a marked glass measuring cup filled with water on the center of the oven rack. If the water level is uneven, refer to the installation instructions for leveling the range. • Be sure to allow 5.1 cm to 10.2 cm (2" to 4") of clearance on all sides of each pan in the oven. • Do not use pans that are dented or warped.
Foods not done when cooking time is up. 	<ul style="list-style-type: none"> • Oven too cool. • Oven overcrowded. • Oven door opened too frequently. 	<ul style="list-style-type: none"> • Set oven temperature 25°F/12°C higher than suggested and bake for the recommended time. • Be sure to remove all pans from the oven except the ones to be used for baking. • Open oven door only after shortest recommended baking time.



Cooking Informations

Broiling Informations

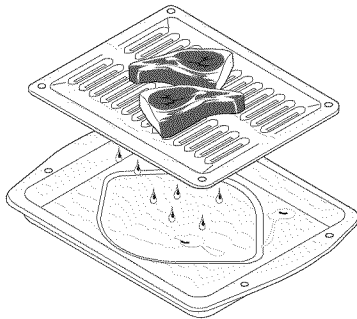
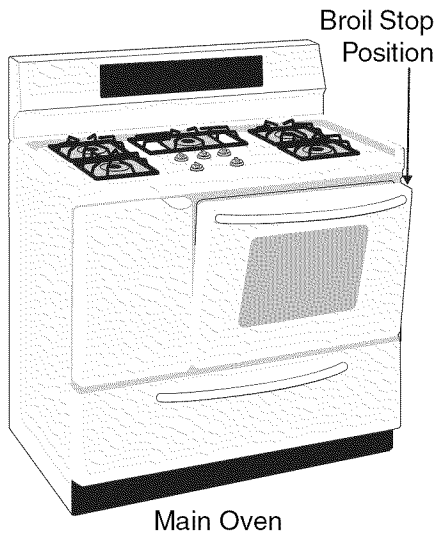

Broiling is a method of cooking tender cuts of meat by direct heat from the broil element of the oven. Meats are placed on the broiling rack and the rack is placed under the broiling element.

See the broiling instructions for main oven in the [Setting Oven Controls section in the Timer Guide](#).

See side oven step-by-step instructions in the Setting Side Oven Control section.

Preheating

Preheating is suggested when searing rare steaks (remove all utensils before preheating; food will stick if placed on hot metal). To preheat, set the oven control(s) to BROIL. Wait for the element to become red-hot, usually about 2 minutes. Preheating is not necessary when broiling meats well-done.

To Broil

Broil on one side until the food is browned; turn and cook on the other side; season and serve. Always pull rack out to the stop position before turning or removing food.

Determining Broiling Times

Broiling times vary; watch the food closely. Time not only depends on the distance from the element, but on the thickness and age of meat, fat content and doneness preferred. The first side usually requires a few minutes longer than the second. Frozen meats also require additional time.

Broiling Tips (some models)

Broiler pan and its grid allow dripping grease to drain and be kept away from the high heat of the broiler.

DO NOT use a pan without its grid. DO NOT cover the grid with foil. The exposed grease could ignite.

⚠ CAUTION Should an oven fire occur, close the oven door and turn off the oven. If the fire continues, throw baking soda on the fire or use a fire extinguisher. **DO NOT put water or flour on the fire.** Flour may be explosive.

Always pull oven rack out to the stop position before turning or removing food.

Broiler Clean-Up Tips (some models):

- To make cleaning easier, line bottom of the broiler pan with aluminum foil. **DO NOT** cover the broiler grid with foil.
- To prevent grease from baking on, remove the broiler pan from the oven as soon as cooking is completed. Use hot pads because the broiler pan is extremely hot. Pour off grease. Soak the pan in **HOT**, soapy water.
- Clean the broiler pan as soon as possible after each use. If necessary, use soap-filled steel wool pads. Heavy scouring may scratch the grid.

Cooking Informations

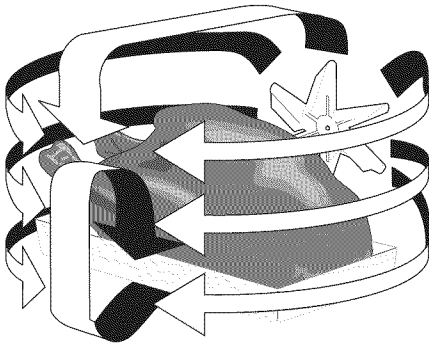

Air circulation during convection cooking.

To select convection cooking mode, press **CONV BAKE ROAST** button on control panel before setting cooking temperature and time.

The convection option, available on some models, is an alternative to the conventional oven cooking methods of baking/roasting.

Convection cooking is a method of cooking in which the heated air of the oven is circulated by a fan at the rear of the oven cavity, providing better heat distribution. This fan is covered by a baffle to circulate the air uniformly, providing even heat distribution for faster and more even cooking, baking and browning. The heated air penetrates food from every angle, sealing in natural moisture and flavors. **The convection fan automatically turns off when the oven door is opened and resumes when the door is closed again.** However, the heating element will stay on.

The oven can be programmed to bake in the convection mode at any temperature from 170°F/80°C to 550°F/288°C. Preheating the oven for 10-12 minutes is recommended when using convection but not necessary when roasting or cooking casseroles.

CAUTION: In the convection mode, using cooking times from conventional cooking recipes may cause food to be **overcooked**. For satisfactory results, use only tested recipes with times adjusted for convection cooking. Obtaining and using a convection oven cookbook is highly recommended.

Convection cooking uses a **lower temperature** and takes **less time** to achieve the same results as conventional cooking. In convection mode, the actual temperature in your oven automatically adjusts to be 25°F/12°C lower than the temperature displayed on the oven control panel. Because of this automatic adjustment you can enter the cooking temperature from your existing conventional cooking recipe, but **do not** set the cooking time to be the same. Even at the lower cooking temperature, convection cooking times will be as much as 30% less than conventional cooking times.

When programming cooking times for convection cooking, enter a time that is 20 to 30 percent less than called for in your conventional cooking recipe. After the cooking cycle ends, decide if the food is done to satisfaction, slightly overdone or slightly underdone (if underdone, cook a short time longer to satisfaction). Make a note of the time and results, and with your next use of the recipe adjust cooking time accordingly.

Convection Roasting

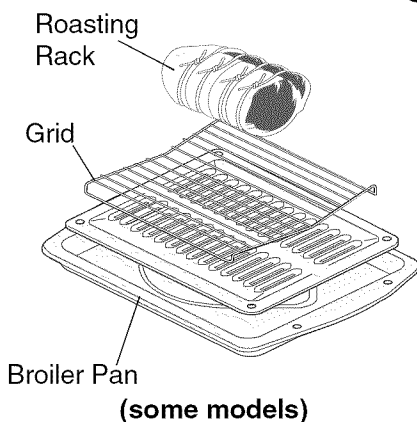

When convection roasting, use a broiler pan and grid, and the roasting rack. Broiler pan will catch grease spills and the grid will help prevent grease spatters. The roasting rack will hold the meat.

1. Place oven rack on bottom or next to bottom rack position.
2. Place the grid in the broiler pan. The roasting rack fits on the grid allowing the heated air to circulate under the food for even cooking and helps to increase browning on the underside. Make sure the roasting rack is securely seated on the grid in the broiler pan. **DO NOT** use broiler pan without the grid. **DO NOT** cover the grid with aluminum foil.

Adjusting Your Oven Temperature

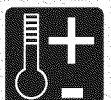

For instructions on how to adjust the oven temperature refer to the electronic oven control guide.



Setting Side Oven Controls

Left Oven
Temperature Control Knob

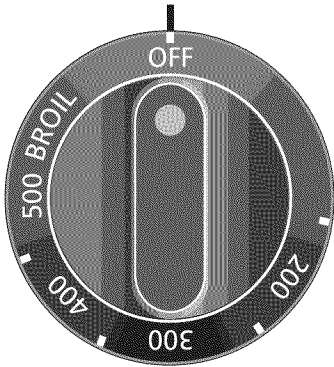

Broil Stop
Position

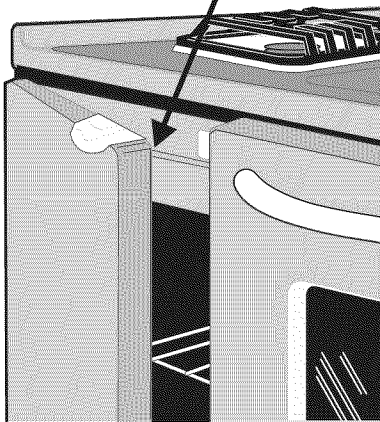

Side Oven

Broiler pan and its grid allow dripping grease to drain and be kept away from the high heat of the broiler. **DO NOT** use the pan without its grid. **DO NOT** cover the grid with foil. The exposed grease could ignite.

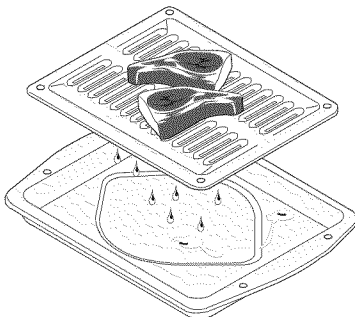

(some models)

To Bake

1. Arrange oven racks while the oven is still cool.
2. Turn the Temperature Control Knob to the desired oven temperature. When the oven is first turned on, the oven indicator light below the Temperature Control Knob will glow.
3. Preheat the oven for 10 to 12 minutes before baking. Preheating is not necessary when roasting, cooking casseroles or broiling most foods. When the desired temperature is reached, the oven indicator light will go out. The light will then go on and off as the element cycles on and off to maintain the desired temperature.
4. When cooking is finished, turn the Temperature Control Knob to OFF.

To Broil

1. Arrange oven rack while oven is still cool. For rare meats, position broiler pan closer to the element (upper position). For well-done foods such as chicken, lobster tails or thick cuts of meat, position the pan further from the element (to a lower position).

Rack Position From Top	Food
1	Rare steaks.
2	Hamslices, fish, hamburgers and medium steaks and chops.
3	Well-done foods such as chicken and lobster.

2. Turn the Temperature Control Knob to BROIL. To sear rare steaks, allow the element to become red-hot—about 2 minutes—before placing food in oven.
3. Place the grid on broiler pan, and then place the meat on the grid. **DO NOT** use broiler pan without the grid or cover the grid with aluminum foil. The exposed fat could ignite.
4. Place the pan on the oven rack. **Close the oven door to the Broil Stop position while broiling (door opened about 2 inches).**
5. Broil on one side until food is browned; turn and cook on the other side. Season and serve. **Note:** Always pull the rack out to the stop position before turning or removing food.
6. When broiling is finished, turn the Temperature Control Knob to OFF.

CAUTION Should an oven fire occur, close the oven door and turn off the oven. If the fire continues, throw baking soda on the fire or use a fire extinguisher. **DO NOT** put water or flour on the fire. Flour may be explosive.

Care & Cleaning



Oven Cleaning

Cleaning the Self-Clean Oven (Main oven)

Adhere to the following cleaning precautions:

- Allow the oven to cool before cleaning.
- Wear rubber gloves when cleaning any exterior parts of the oven manually.

CAUTION During the self-clean cycle, the outside of the wall oven can become very hot to the touch. **DO NOT** leave small children unattended near the appliance.

CAUTION The health of some birds is extremely sensitive to the fumes given off during the self-cleaning cycle of any range. Move birds to another well ventilated room.

CAUTION Before cleaning any part of the oven, be sure the electronic oven control is turned off or else push **CANCEL** pad. Wait until the oven is cool.

DO NOT use commercial oven cleaners or oven protective coatings in or around any part of the self-cleaning oven. **DO NOT** clean the oven door gasket. The gasket on the oven door is essential for a good seal. Care should be taken not to rub, damage or move the gasket. **DO NOT use any cleaning materials on the gasket. Doing so could damage it. DO NOT use aluminum foil to line the oven bottom.** This may affect cooking or foil could melt and damage the oven surface.

A self-cleaning oven cleans itself with high temperatures (well above cooking temperatures) which eliminate soil completely or reduce it to a fine powdered ash you can wipe away with a damp cloth.

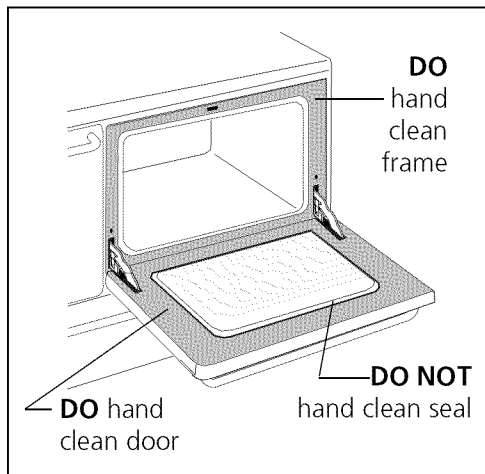

Preparing the Oven for Self-Cleaning

1. Remove all excess spillovers in the oven cavity before starting the self-cleaning cycle. To clean, use hot soapy water and a cloth. Large spillovers can cause heavy smoke or fire when subjected to high temperatures. **DO NOT** allow food spills with a high sugar or acid content (such as tomatoes, sauerkraut, fruit juices or pie filling) to remain on the surface as they may cause a dull spot even after cleaning.
2. Clean any soil from the oven frame and the door liner (see illustration). These areas heat sufficiently during self-cleaning cycle to burn soil on. Clean with soap and water.
3. Remove the broiler pan and insert, all utensils and any foil. These items do not withstand high cleaning temperatures.
4. Oven racks may be left in the oven or may be removed. If they go through the clean cycle, their color will turn slightly dull. After the cycle is completed and the oven has cooled, rub the sides of the racks with wax paper or a cloth containing a small amount of baby oil or salad oil. This will make the racks glide easier.

What to Expect During Cleaning

While the oven is in operation, the oven heats to temperatures much higher than those used in normal cooking. Sounds of metal expansion and contraction are normal. Odor is also normal as the food soil is being removed. Smoke may appear through the oven vent, located on the top of the control panel.

If heavy spillovers are not wiped up before cleaning, they may flame and cause more smoke and odor than usual. This is normal and safe and should not cause alarm. If available, use an exhaust fan during the self-cleaning cycle.

NOTE: A smoke eliminator in the oven vent converts most of the soil into a colorless vapor.

Setting Oven Controls for Self-Clean Cycle



Refer to the Electronic Oven Control Guide for oven settings.



Care & Cleaning

Porcelain Enamel Oven Cleaning (Side Oven) (If equipped)

Adhere to the following cleaning precautions:

- Allow the oven to cool before cleaning.
- Wear rubber gloves when cleaning the appliance manually.

Remove spillovers and heavy soils as soon as possible. Regular cleanings will reduce the number of future major cleanings.

CAUTION Ammonia must be rinsed before operating the oven. Provide adequate ventilation.

Porcelain has a smooth finish and is a type of glass fused to metal. Oven cleaners can be used on all interior oven surfaces.

General Cleaning

Remove soils using hot, soapy water. Do not allow food spills with a high sugar or acid content (such as milk, tomatoes, sauerkraut, fruit juices or pie filling) to remain on the surface as they may cause a dull spot even after cleaning.

To Remove Heavy Soil

1. Allow a dish of ammonia to sit in the oven overnight or for several hours with the oven door closed. Clean softened spots using hot, soapy water. Rinse well with water and a clean cloth.
2. If soil remains, use a soap-filled scouring pad or a nonabrasive cleaner. If necessary, use an oven cleaner following manufacturer's instructions. **DO NOT** mix ammonia with other cleaners.

Adhere to the following precautions when using oven cleaners:

1. **DO NOT** spray on the electrical controls or switches because it could cause a short circuit and result in sparking or fire.
2. **DO NOT** allow a film from the cleaner to build up on the temperature sensing bulb located at the top left rear corner of the oven; it could cause the oven to heat improperly. Carefully wipe the bulb clean after each oven cleaning, being careful not to move the bulb. A change in its position could affect how the oven bakes. Avoid bending the bulb and capillary tube.
3. **DO NOT** spray any cleaner on the oven door trim or gasket, handles or any exterior surfaces of the range, wood or painted surfaces. The cleaner can damage these surfaces.

To Clean the Oven Bottom

Clean using hot, soapy water, a mild abrasive cleanser, a soap-filled abrasive pad or oven cleaner following oven cleaner manufacturer's instructions.

CAUTION **DO NOT** line the oven walls, bottom, racks or any other part of the appliance with aluminum foil. Doing so will destroy heat distribution, produce poor baking results and cause permanent damage to the oven interior (aluminum foil will melt to the interior surface of the oven).

Care & Cleaning

(Cleaning Chart)



Cleaning Various Parts of Your Range

Before cleaning any part of the range, be sure all controls are turned OFF and the range is COOL. REMOVE SPILLOVERS AND HEAVY SOILING AS SOON AS POSSIBLE. REGULAR CLEANING WILL REDUCE THE NUMBER OF MAJOR CLEANING LATER.

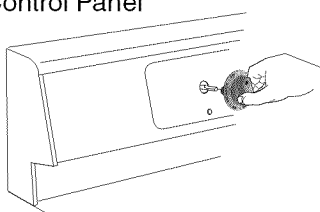
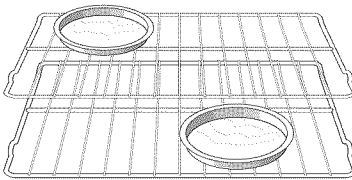
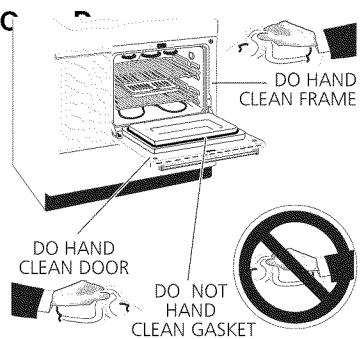
Surfaces	How to Clean
Vinyl and Aluminum (Trim Pieces)	Use hot, soapy water and a cloth. Dry with a clean cloth.
Control Panel 	<i>Before cleaning the control panel</i> , turn all controls to OFF and remove the control knobs. To remove, pull each knob straight off the shaft. Clean using hot, soapy water and a dishcloth. Be sure to squeeze excess water from the cloth before wiping the panel; especially when wiping around the controls. Excess water in or around the controls may cause damage to the appliance. To replace knobs after cleaning, line up the flat sides of both the knob and the shaft; then push the knob into place.
Stainless Steel Control panel, Oven door and Drawer front panel	Cleaners made especially for stainless steel as Stainless Steel Magic, or other similar cleaners are recommended. Always follow the manufacturer's instructions. Be sure to rinse the cleaners as bluish stains may occur during heating and cannot be removed.
Oven Racks 	Remove racks. See "To remove and to replace an Oven Rack" under Setting Oven Controls . Use a mild, abrasive cleaner, following manufacturer's instructions. Rinse with clean water and dry. After cleaning the racks, rub the sides of the racks with wax paper or a cloth containing a small amount of baby oil or salad oil (this will make the racks glide easier into the rack positions).
Cooktop, under Cooktop, Broiler Pan and Insert (some models), Door Liner, Small Oven	Gentle scouring with a soapy scouring pad will remove most spots. Rinse with a 1:1 solution of clear water and ammonia. <i>If necessary</i> , cover difficult spots with an ammonia-soaked paper towel for 30 to 40 minutes. Rinse with clean water and a damp cloth and then scrub with a soap-filled scouring pad. Rinse and wipe dry with a clean cloth. Remove all cleaners or the porcelain may become damaged during future heating. DO NOT use spray oven cleaners on the cooktop.
	To clean oven door, wash with hot, soapy water and a clean cloth. DO NOT immerse the door in water. DO NOT clean the oven door gasket. The oven door gasket is made of a woven material which is essential for a good seal. Care should be taken not to rub, damage or remove the gasket.
Glass, Paint and Plastic Control Knobs, Body Parts and Decorative Trim	<i>For general cleaning</i> , use hot, soapy water and a cloth. <i>For more difficult soils and built-up grease</i> , apply a liquid detergent directly onto the soil. Leave on soil for 30 to 60 minutes. Rinse with a damp cloth and dry. DO NOT use abrasive cleaners on any of these materials; they can scratch. To remove control knobs, turn to the OFF position; grasp firmly and pull straight off the shaft. To replace knobs after cleaning, line up the flat sides of both the knob and the shaft; then push the knob into place.



Care & Cleaning

Models with Ceramic Glass Cooktop

Ceramic Glass Cooktop Cleaning & Maintenance

Consistent and proper cleaning is essential to maintaining your Ceramic glass cooktop

Prior to using your cooktop for the first time, apply the recommended Cleaning Creme to the ceramic surface. Clean and buff with a non abrasive cloth or pad. This will make cleaning easier when soiled from cooking. The special cooktop cleaning cream leaves a protective finish on the glass to help prevent scratches and abrasions.

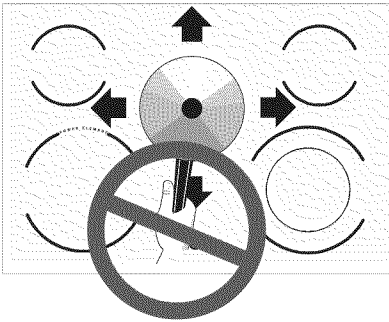

Sliding aluminum or copper clad bottom pans on the cooktop can cause metal markings on the cooktop surface. These marks should be removed **immediately** after the cooktop has cooled using the cooktop cleaning cream. Metal marks can become permanent if not removed prior to future use.

Cookware (cast iron, metal, ceramic or glass) with rough bottoms can mark or scratch the cooktop surface. **Do not slide anything metal or glass** across the cooktop. **Do not** use your cooktop as a cutting board or work surface in the kitchen. **Do not** cook foods directly on the cooktop surface without a pan. **Do not** drop heavy or hard objects on the glass cooktop, or they may crack it.

CAUTION Before cleaning the cooktop, be sure the controls are turned to **OFF** and the cooktop is **COOL**.

WARNING **DO NOT** use a cooktop cleaner on a hot cooktop. The fumes can be hazardous to your health, and can chemically damage the ceramic glass surface.

Cleaning Recommendations for the Ceramic Glass Cooktop

For light to moderate soil:

Apply a few drops of Cleaning Creme directly to the cooktop. Use a paper towel or a Multi-Purpose No Scratch Scrub Sponge to clean the entire cooktop surface. Make sure the cooktop is cleaned thoroughly, leaving no residue. Do not use the sponge you use to clean the cooktop for any other purpose.

For heavy, burned on soil:

First, clean the surface as described above. Then, if soils remain, carefully scrape soils with a metal razor blade scraper, holding scraper at a 30 degree angle to the surface. Remove loosened soils with cooktop cleaning cream and buff surface clean.

CAUTION Damage to the ceramic glass cooktop may occur if you use any scrub pad other than a Multi-Purpose No Scratch Scrub Sponge.

Plastic or foods with a high sugar content:

These types of soils need be removed immediately if spilled or melted onto the ceramic cooktop surface. Permanent damage (such as pitting of the cooktop surface) may occur if not removed **immediately**. After turning the surface elements **OFF**, use a razor blade scraper or a metal spatula with a mitt and scrape the soil from the hot surface (as illustrated). Allow the cooktop to cool, and use the same method for heavy or burned on soils.

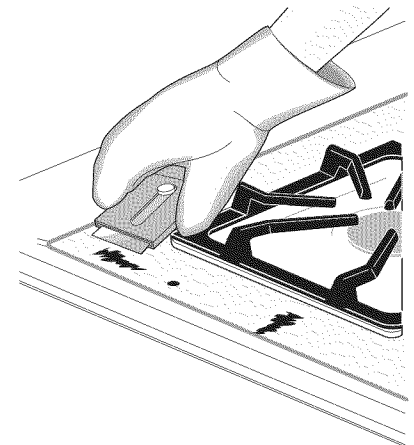

Care & Cleaning



Do not use the following on the ceramic glass cooktop:

- Do not use abrasive cleaners and scouring pads, such as metal and some nylon pads. They may scratch the cooktop, making it more difficult to clean.
- Do not use harsh cleaners, such as chlorine bleach, ammonia or oven cleaners, as they may etch or discolor the cooktop.
- Do not use dirty sponges, cloths or paper towels, as they can leave soil or lint on the cooktop which can burn and cause discoloration.

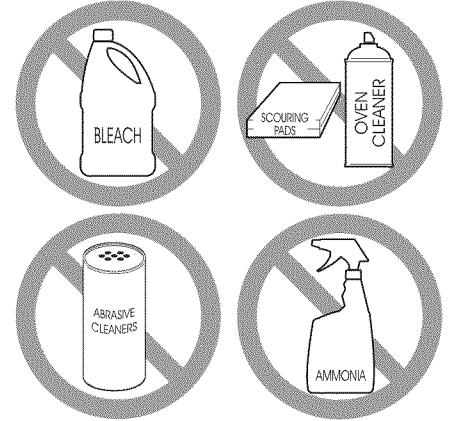

Special Caution for Aluminum Foil and Aluminum Cooking Utensils

- **Aluminum foil**
Use of aluminum foil will damage the cooktop. Do not use under any circumstances.
- **Aluminum utensils**
Since the melting point of aluminum is much lower than that of other metals, care must be taken when aluminum pots or pans are used. Pans that boil dry may permanently damage cooktop by breaking, fusing to, or marking it.

Care and Cleaning of Stainless Steel (Stainless Steel models only)

Some models are equipped with stainless steel exterior parts. Special care and cleaning are **required** for maintaining the appearance of stainless parts. Please refer to the table provided at the beginning of the **General Care & Cleaning** section in this Use & Care Guide.



Care & Cleaning

To Clean the Burner Grates, Contoured Burner Pans, Burner Caps, and Burner Bases.

The burner grates, contoured burner pans, burner cap, and burner base should be routinely cleaned. Keeping the burner ports clean will prevent improper ignition and an uneven flame. Follow instructions below.

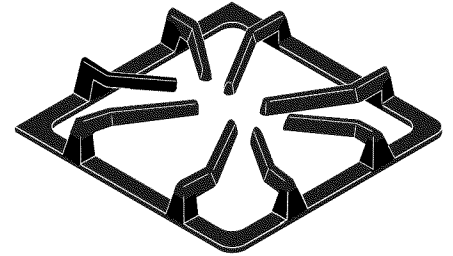

To Clean the Contoured Burner Pans

The square burner pans are attached to the cooktop and are not removable. The burner pan forms a recessed well area located around each burner unit. If a spill occurs in one of the four well areas, blot up spill with an absorbent cloth. Rinse with a clean, damp cloth and wipe dry.

To Clean the Grates

Any remaining soil may be removed by gently scouring with a soapy scouring pad. Rinse with a 1:1 solution of clean water and ammonia. *If necessary*, cover difficult spots with an ammonia-soaked paper towel for 30 to 40 minutes. Rinse with clean water and a damp cloth, then scrub with a soap-filled scouring pad. Rinse and wipe dry with a clean cloth. Remove all cleaners thoroughly or the grate porcelain may become damaged during future heating. **DO NOT** use spray oven cleaners.

To Clean the Burner Caps

Use a soap-filled scouring pad or a mild abrasive cleanser to clean burner caps. If necessary, cover stubborn spots with an ammonia-soaked paper towel for 30 minutes. Rub gently with a soap-filled scouring pad and rinse with a mixture of clean water and vinegar. Wipe dry. Remove all cleaners thoroughly or the burner cap porcelain may become damaged during future heating.

To Clean the Burner Bases and Gas Openings

The ports (or slots) around the burner base must be routinely cleaned. Use a small-gauge wire or needle to clean small slots or holes. Use care to prevent damage to the electrode. If a cleaning cloth should catch the electrode, it could break or damage the electrode. If the electrode is damaged or broken, the surface burner will not light because it will not spark. Manual lighting with a match is still possible.

For proper flow of gas and ignition of the burner—**DO NOT ALLOW SPILLS, FOOD, CLEANING AGENTS OR ANY OTHER MATERIAL TO ENTER THE GAS OPENING.** Gas must flow freely through the small hole in the brass orifice for the burners to light properly. If the gas opening orifice becomes soiled or clogged, use a small-gauge wire or needle to clean. **ALWAYS** keep the burner cap assembly and ring in place whenever a surface burner is in use.

After cleaning make sure each burner cap is properly aligned and level. Turn the burner on to determine if it will light. If the burner does not light after cleaning, contact a Service Center. Do not service the sealed burner yourself.

Care & Cleaning

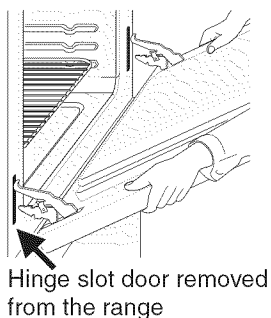
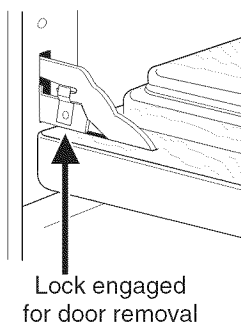
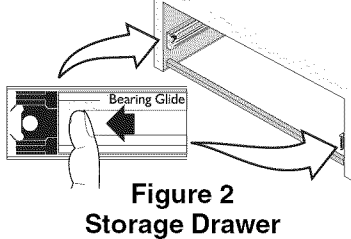
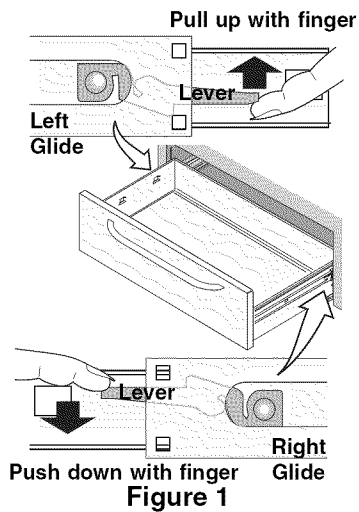

Storage Drawer

Use the storage drawer for storing cooking utensils. The drawer can be removed to facilitate cleaning under the range. Use care when handling the drawer.

To Remove Storage Drawer:

1. Open the drawer to the fully opened position.
2. Locate the glide lever on each side of drawer; pull up on the left glide lever and push down on the right glide lever (see figure 1).
3. Pull the drawer away from the range.

To Replace Storage Drawer:

1. Pull the bearing glides to the front of the range (see figure 2).
2. Align the drawer glides with the slots on the bearing glides.
3. Push the drawer into the range until the glides levers “click” (approx. 2 in.). Pull the drawer open again to seat it into position.
4. **If you do not hear the glide levers “click” or if the drawer does not feel seated, remove it and repeat steps 1 through 3.** Doing so will minimize damage to the bearing glides. Do not try to force the drawer into place.

⚠ WARNING Flammable materials should not be stored in an oven, near surface elements or in the storage drawer or compartment (if equipped). This includes paper, plastic and cloth items, such as cookbooks, plasticware and towels, as well as flammable liquids. Do not store explosives, such as aerosol cans, on or near the range. Flammable materials may explode and result in fire or property damage.

To Remove and Replace Right Oven Door

1. Open the door to the fully opened position.
2. Pull up the lock located on both hinge supports and engage it in the hinge levers. You may have to apply a little downward pressure on the door to pull the locks fully over the hooks.
3. Grab the door by the sides, pull the bottom of the door up and toward you to disengage the hinge supports. Keep pulling the bottom of the door toward you while rotating the top of the door toward the range to completely disengage the hinge levers.
4. To replace the door, reverse the door removal steps. Make sure the hinge supports are fully engaged before unlocking the hinge levers.

⚠ CAUTION The door is heavy. After removing door, lay it flat on the floor with its inside facing down.

To Change the Oven Light

The oven light automatically turns on when the door is opened (some models). To turn the oven light on and off when the door is closed, use the OVEN LIGHT switch located on the control panel.

1. Turn electrical power off at the main source or unplug the oven.
2. Wear a leather-faced glove for protection against possible broken glass.
3. Press wire holder to one side to release the glass shield.
4. Replace bulb with a new 40 watt appliance bulb.
5. Replace glass shield in socket and snap wire holder into place.
6. Turn power back on at the main source (or plug the appliance back in).
7. The clock will then need to be reset. To reset, see **Setting the Clock and Minute Timer** in the ELECTRONIC OVEN CONTROL manual.

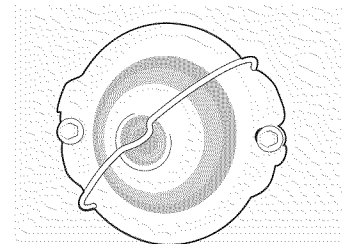

⚠ CAUTION Be sure the oven is unplugged and all parts are COOL before replacing the oven light bulb. Do not turn the oven light on during a self-cleaning cycle. High temperature will reduce lamp life.



Before you call *Solutions to Common Problems*

Avoid Service Checklist

You may save the cost and inconvenience of an unnecessary service call by first reviewing this Checklist of commonly encountered problem situations.

You will be charged for a service call while the appliance is in warranty if the problem is not caused by defective product workmanship or materials.

OCCURRENCE	POSSIBLE CAUSE/SOLUTION
Range is not level.	1) Poor installation. When range is level, cooktop may appear out of alignment if countertop is not level. 2) Weak, unstable floor. Be sure floor is level and can adequately support range. Contact a carpenter to correct sagging or sloping floor. 3) Kitchen cabinet misalignment may make range appear to be unlevel. Be sure cabinets are square and have sufficient room for range clearance.
Cannot move appliance easily. Appliance must be accessible for service.	1) Cabinets not square or are built in too tight. Contact a cabinet maker to correct the problem. 2) Contact builder or installer to make appliance accessible. 3) Carpeting interferes with range. Provide sufficient space so range can be lifted over carpet.
Entire range or oven does not operate.	1) Make sure cord/plug is tightly into outlet. 2) Service wiring is not complete. Contact your dealer, installing agent or authorized servicer. 3) Power outage. Check house lights to be sure. Call your local electric company for service.
*Oven control beeps and displays F10, F30 or F90.	1) Electronic control has detected a fault condition. Push CLEAR to clear the display and stop beeping. Program oven again. If fault recurs, record fault number. Push CLEAR and contact an authorized servicer.
Oven and/or cooktop lights does not work.	1) Replace or tighten bulb. See “Changing Oven Light” in this Guide for instructions.
Surface unit does not heat.	1) No power to the appliance. Check steps under “Entire Range or Oven Does Not Operate” in this Avoid Service Checklist. 2) Incorrect control setting. Make sure the correct control is on for the surface unit to be used.
Surface burners do not light.	1) Surface control knob has not been completely turned to LITE. Push in and turn the surface control knob to LITE (until burner ignites) and then turn the surface control knob to the desired flame size. 2) Burner ports are clogged. Clean burners. See “To Clean Burner Grates, Contoured Burner Pans, Burner Cap and Burner Base” under General Cleaning. With the burner off, use small-gauge wire or needle to clean ports or slots. 3) Gas supply is turned off. Turn gas supply on.
Surface burner flame burns half way around.	1) Burner ports or slots are clogged. With the burner off, clean by using a small-gauge wire or needle to lean ports or slots. 2) Moisture is present after cleaning. Lightly fan the flame and allow the burner to operate until flame is full. Dry the burners thoroughly following instructions under General Cleaning.
Surface burner flame is orange.	1) Dust particles in main line. Allow the burner to operate a few minutes until flame turns blue. 2) Salt air in coastal areas. A slightly orange flame is unavoidable.
Scratches or abrasions on cooktop surface.	1) Coarse particles such as salt or sand between cooktop and utensil can cause scratches. Be sure cooktop surface and bottoms of utensils are clean before usage. Small scratches do not affect cooking and will become less visible with time. 2) Cleaning materials not recommended for ceramic-glass cooktop have been used. See “To Clean the Cooktop Glass” section under general cleaning. 3) Cookware with rough bottom has been used. Use smooth, flat-bottomed cookware.
Metalmarks.	1) Sliding or scraping of metal utensils on cooktop surface. Do not slide metal utensils on cooktop surface. Use a ceramic-glass cooktop cleaning cream to remove the marks. See “To Clean the Cooktop Glass” section under General Cleaning.

Before you call *Solutions to Common Problems*



Brown streaks or specks.	1) Boilover are cooked onto surface. Use razor blade scraper to remove soil. See “To Clean the Cooktop Glass” section under General Cleaning.
Areas of discoloration with metallic sheen.	1) Mineral deposits from water and food. Remove using a ceramic-glass cooktop cleaning cream. Use cookware with clean, dry bottoms.
Poor baking results.	1) Many factors affect baking results. Make sure the proper rack position is used. Center food in the oven and space pans to allow air to circulate. Allow the oven to preheat to the set temperature before placing food in the oven. Try adjusting the recipes’ recommended temperature or baking time. If you feel the oven is too hot or cool, see “ Adjusting Oven Temperature ” in the ELECTRONIC OVEN CONTROL guide.
Flames inside oven or smoking from vent.	1) Excessive spillovers in oven. Set self-clean cycle for a longer cleaning time. 2) Excessive spillovers in oven. This is normal, especially for pie spillovers or large amounts of grease on the oven bottom. Wipe up excessive spillovers before starting the self-clean cycle. If flames or excessive smoke are present, stop the self-clean cycle and follow the steps under “ Stopping or Interrupting the Self-Cleaning Cycle ” in the ELECTRONIC OVEN CONTROL guide.
Oven smokes excessively during broiling.	1) Control(s) not set properly. Follow instructions under “ Setting Oven Controls ” in the ELECTRONIC OVEN CONTROL guide. 2) Make sure oven door is opened to the Broil Stop Position . 3) Meat too close to the element. Reposition the rack to provide proper clearance between the meat and the element. Preheat broil element. Preheat broil element for searing. 4) Grid on broiler pan wrong side up and grease not draining. Always place grid on the broiler pan with ribs up and slots down to allow grease to drip into pan. 5) Grease has built up on oven surfaces. Regular cleaning is necessary when broiling frequently. Old grease or food spatters cause excessive smoking.
Self-cleaning cycle does not work.	1) Control(s) not set properly. Follow instructions under “ Oven Cleaning ” in the ELECTRONIC OVEN CONTROL guide. 2) Self-cleaning cycle was interrupted. Stop time must be 3 to 4 hours past the start time. Follow steps under “ Stopping or Interrupting the Self-Cleaning Cycle ” in the ELECTRONIC OVEN CONTROL guide.
Soil not completely removed after self-cleaning cycle.	1) Failure to clean bottom, front top or oven, frame or door area outside oven seal. These areas are not in the self-cleaning area, but get hot enough to burn on residue. Clean these areas before the self-cleaning cycle is started. Burned-on residue can be cleaned with a stiff nylon brush and water or nylon scrubber. Be careful not to damage the oven seal.



Major Appliance Warranty Information

Your appliance is covered by a one year limited warranty. For one year from your original date of purchase, Electrolux will pay all costs for repairing or replacing any parts of this appliance that prove to be defective in materials or workmanship when such appliance is installed, used and maintained in accordance with the provided instructions.

Exclusions **This warranty does not cover the following:**

1. Products with original serial numbers that have been removed, altered or cannot be readily determined.
2. Product that has been transferred from its original owner to another party or removed outside the USA or Canada.
3. Rust on the interior or exterior of the unit.
4. Products purchased "as-is" are not covered by this warranty.
5. Food loss due to any refrigerator or freezer failures.
6. Products used in a commercial setting.
7. Service calls which do not involve malfunction or defects in materials or workmanship, or for appliances not in ordinary household use or used other than in accordance with the provided instructions.
8. Service calls to correct the installation of your appliance or to instruct you how to use your appliance.
9. Expenses for making the appliance accessible for servicing, such as removal of trim, cupboards, shelves, etc., which are not a part of the appliance when it is shipped from the factory.
10. Service calls to repair or replace appliance light bulbs, air filters, water filters, other consumables, or knobs, handles, or other cosmetic parts.
11. Surcharges including, but not limited to, any after hour, weekend, or holiday service calls, tolls, ferry trip charges, or mileage expense for service calls to remote areas, including the state of Alaska.
12. Damages to the finish of appliance or home incurred during installation, including but not limited to floors, cabinets, walls, etc.
13. Damages caused by: services performed by unauthorized service companies; use of parts other than genuine Electrolux parts or parts obtained from persons other than authorized service companies; or external causes such as abuse, misuse, inadequate power supply, accidents, fires, or acts of God.

DISCLAIMER OF IMPLIED WARRANTIES; LIMITATION OF REMEDIES

CUSTOMER'S SOLE AND EXCLUSIVE REMEDY UNDER THIS LIMITED WARRANTY SHALL BE PRODUCT REPAIR OR REPLACEMENT AS PROVIDED HEREIN. CLAIMS BASED ON IMPLIED WARRANTIES, INCLUDING WARRANTIES OF MERCHANTABILITY OR FITNESS FOR A PARTICULAR PURPOSE, ARE LIMITED TO ONE YEAR OR THE SHORTEST PERIOD ALLOWED BY LAW, BUT NOT LESS THAN ONE YEAR. ELECTROLUX SHALL NOT BE LIABLE FOR CONSEQUENTIAL OR INCIDENTAL DAMAGES SUCH AS PROPERTY DAMAGE AND INCIDENTAL EXPENSES RESULTING FROM ANY BREACH OF THIS WRITTEN LIMITED WARRANTY OR ANY IMPLIED WARRANTY. SOME STATES AND PROVINCES DO NOT ALLOW THE EXCLUSION OR LIMITATION OF INCIDENTAL OR CONSEQUENTIAL DAMAGES, OR LIMITATIONS ON THE DURATION OF IMPLIED WARRANTIES, SO THESE LIMITATIONS OR EXCLUSIONS MAY NOT APPLY TO YOU. THIS WRITTEN WARRANTY GIVES YOU SPECIFIC LEGAL RIGHTS. YOU MAY ALSO HAVE OTHER RIGHTS THAT VARY FROM STATE TO STATE.

If You Need Service

Keep your receipt, delivery slip, or some other appropriate payment record to establish the warranty period should service be required. If service is performed, it is in your best interest to obtain and keep all receipts. Service under this warranty must be obtained by contacting Electrolux at the addresses or phone numbers below.

This warranty only applies in the USA and Canada. In the USA, your appliance is warranted by Electrolux Major Appliances North America, a division of Electrolux Home Products, Inc. In Canada, your appliance is warranted by Electrolux Canada Corp. Electrolux authorizes no person to change or add to any obligations under this warranty. Obligations for service and parts under this warranty must be performed by Electrolux or an authorized service company. Product features or specifications as described or illustrated are subject to change without notice.

USA

1.800.944.9044
Electrolux Major Appliances
North America
P.O. Box 212378
Augusta, GA 30907



Canada

1.800.668.4606
Electrolux Canada Corp.
5855 Terry Fox Way
Mississauga, Ontario, Canada
L5V 3E4