

GE Monogram[®]

Installation

Instructions

Component
Cooktop
System

Models

ZEW145

ZGW124

ZGW125

ZEW155

ZEW166

ZEW176

Before you begin—Read these instructions completely and carefully.

IMPORTANT: Save these instructions for local inspector’s use.

IMPORTANT: OBSERVE ALL GOVERNING CODES AND ORDINANCES.

NOTE TO INSTALLER: Be sure to leave these instructions with the Consumer.

NOTE TO CONSUMER: Keep these instructions with your Owner’s Manual for future reference.

⚠ WARNING This appliance must be properly grounded. See “Electrical Supply”, page 13.

**For Monogram local service in your area,
1-800-444-1845.**

**For Monogram service in Canada,
1-888-880-3030.**

**For Monogram Parts and Accessories, call
1-800-626-2002.**

If you received a damaged component, you should contact your dealer.

Installation of these components require basic mechanical skills. Proper installation is the responsibility of the installer.

**CAUTION: FOR PERSONAL SAFETY,
REMOVE HOUSE FUSE OR CIRCUIT
BREAKER BEFORE BEGINNING
INSTALLATION.**

These appliances must be supplied with the proper voltage and frequency, as listed on page 18. Connect to an individual, properly grounded branch circuit breaker or time delay fuse. Proper electrical ratings should be verified with listing on product’s rating plate.

Wiring must conform to the requirements of the National Electrical Code. If the electric supply provided does not meet the specifications, call a licensed electrician.

WARNING:

Any home ventilation system, such as a cooktop with a downdraft mechanism, may interfere with the proper flow of exhaust products or combustion air required by gas furnaces, gas water heaters, fireplaces, or

other naturally vented systems. To minimize the chance of interference with such naturally vented systems, follow the heating equipment manufacturer’s guidelines, and local codes. Also follow the guidelines in ASHRAE Standard 62-1989, “Ventilation for Acceptable Indoor Air Quality”, section 5.8. When following these guidelines, be sure to test for proper airflow direction into the draft hood of a naturally vented gas furnace or water heater. This can be checked by striking a match, blowing it out, and while it is still smoking, holding it near the draft hood relief opening. If smoke is drawn into the opening, vent flow is in the proper direction. If the ASHRAE Standard 62 guidelines are not satisfied, a positive supply of outside air may have to be supplied.

In the absence of local codes, the gas cooktop must comply with the National Fuel Gas Code, ANSI Z223.1, latest edition.

Contents

Models Available	3	Install Blower Assembly	11
Product Dimensions	3, 4	Finalize Ductwork	11
Installation Accessories	5	Duct Fittings	12
Advance Planning	5	Gas Supply Location	13
Installation Options	5	Electrical Supply	13
Installation Rules	5	Step 1: Apply Gasket Strip	14
Installation Location	6	Step 2: Remove Knobs, Gates	14
Tools & Materials Required	7	Step 3: Joining Multiple Cooktops	14, 15, 16
Cutout Information	7, 8, 9	Step 4: Secure Cooktop(s) to Countertop	16
Venting Options	10	Step 5: Connect Gas	17
Ductwork Advance Planning	10	Step 6: Connect Electrical	17, 18
Optional Ductwork Arrangement	10	Electrical Power Requirements	18
Determine Ductwork Location	11	Finalize Installation	19

Design Information

Component Cooktop System

Models Available

Monogram Component Cooktop System offers cooking flexibility with modular cooktops in a variety of cooking technologies to meet any cooking need.

ZEW145
Radiant Cooktop Component

ZEW155
Updraft Grill Cooktop Component,

ZEW166
Downdraft Grill Cooktop Component

ZEW176
Downdraft Vent Component

ZGW124
Gas Cooktop Component,
with right hand controls

ZGW125
Gas Cooktop Component,
with left hand controls

JXBA55 blower motor assembly is supplied for the downdraft vent and downdraft grill. JXBC55 optional outdoor cover accessory may be ordered for installation of blower and motor assembly on an outside wall.

Product Dimensions

ZEW145
Radiant Cooktop Component
(240 and 208 volt, dual rated)
Parts supplied:

- 44" flexible conduit
- One joiner strip
- Two sets clamping screws
- One chassis support brace

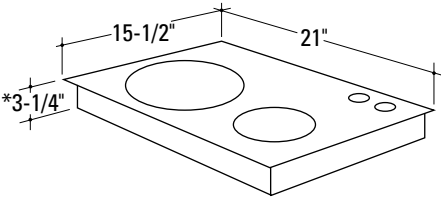

*Allow additional 1" depth for clearance of flexible conduit

ZEW155
Updraft Grill Cooktop Component
(240 volt)
Parts supplied:

- Grease collection jar
- 48" flexible conduit
- One joiner strip
- Two sets clamping screws
- One chassis support brace

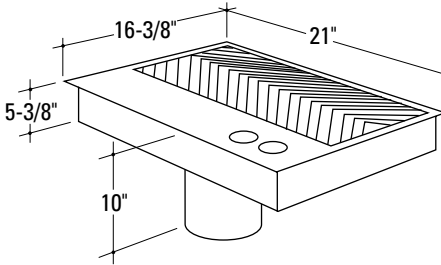

ZEW176
Downdraft Vent Component
Install next to gas or radiant components.
(Cannot be installed next to an updraft grill)
(120 volt)
Parts supplied:

- 48" flexible conduit
- Two downdraft joiner strips
- One downdraft endcap
- JXBA55 blower motor assembly

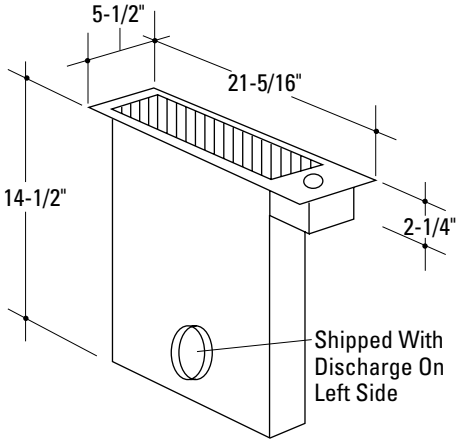

NOTE: The downdraft plenum is shipped with the discharge outlet on the left side. It can be changed to the right side.

Design Information

Component Cooktop System

Product Dimensions

ZEW166

Downdraft Grill Cooktop Component
(240 volt)

Parts supplied:

- Grease collection jar
- 48" flexible conduit
- One set clamping screws
- One downdraft joiner strip
- JXBA55 blower motor assembly

NOTE: The downdraft plenum is shipped with the discharge outlet on the left side. It can be changed to the right side.

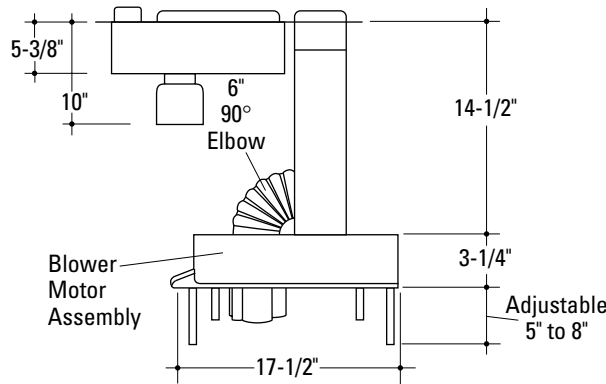
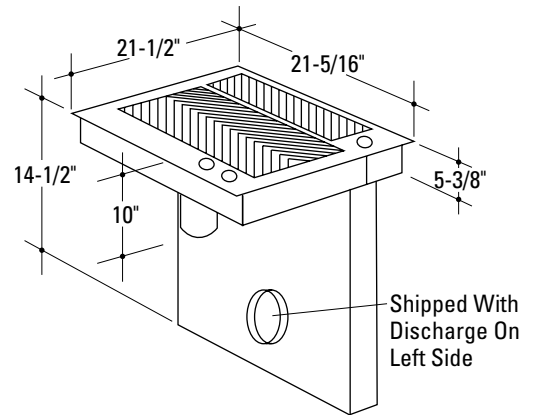

Front View, Downdraft Grill With Blower Motor Assembly

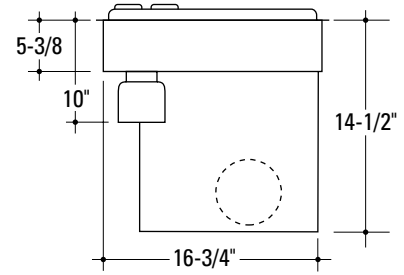

Left Side View, Downdraft Grill

ZGW124

Gas Cooktop Component,
with right hand controls

ZGW125

Gas Cooktop Component,
with left hand controls

Parts supplied with each:

- 1/2" inlet pipe
- Pressure regulator
- One joiner strip
- Two sets clamping screws
- One chassis support brace

NOTE: Gas components are designed for natural gas operations and cannot be converted to LP operation.

If installation includes a drawer beneath gas cooktop, make allowance for gas inlet pipe. Gas inlet extends 1-1/4" from bottom.

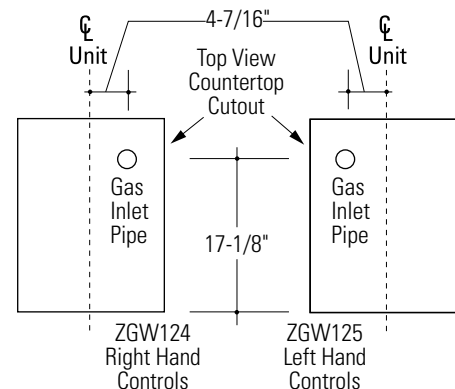
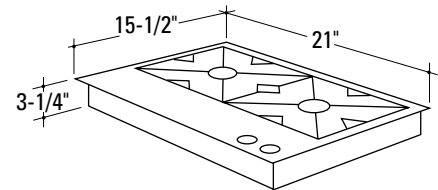
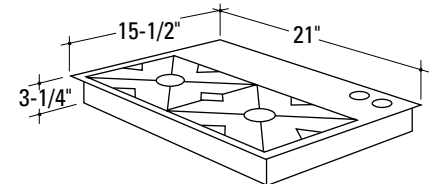

Design Information

Component Cooktop System

Installation Accessories Provided

Joiner strips and end caps are included to provide a finished look to any modular cooktop arrangement.

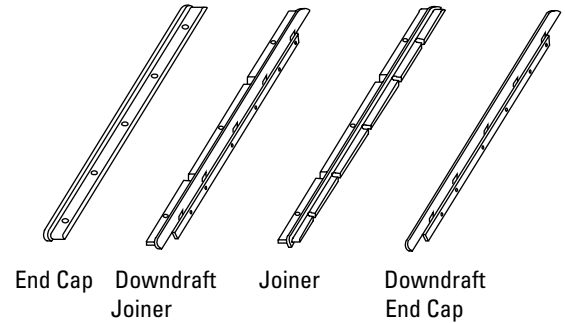

Advance Planning

- Consider base cabinet storage arrangements to accommodate the downdraft blower/motor assembly.
 - The downdraft plenum assembly will occupy the cabinet below the cooktop. Drawers cannot be installed below the downdraft vent or downdraft grill components. The blower may be installed in the cabinet or located downstream from the plenum in the duct run.
 - Shorter length drawers may be installed below gas components, allowing for gas inlet clearance.
 - Do not cut holes for ductwork locations until components are on-site, with countertop in place, and all pre-planned locations are confirmed.
 - Always pre-plan electrical and gas connections to be accessible at the time of installation.
 - Consider the distance to power supply, cable length and bending restrictions before cutting holes.
 - **Gas components are not convertible to liquid propane operation.**
 - In the absence of local codes, the gas cooktop must comply with the National Fuel Gas Code, ANSI Z223.1, latest edition.
- UL, A.G.A. approved.

Installation Options

- Multiple gas and electric components can be combined to form one custom cooking arrangement.
 - Multiple electric components can operate from a single junction box, if local codes permit.
 - Multiple gas components can operate from a manifold, as permitted by local codes.
- Updraft components can be vented according to normal exhausting methods.
- The downdraft vent and grill blower assembly may be vented downwards to the left or right sides or through the floor. See page 11.
- The motor blower assembly can be mounted in the cabinet or under the floor. The blower will fit between floor joists on 16" centers.
- The plenum on the downdraft grill and vent is shipped with the discharge on the left side. It can be changed to discharge from the right side.
- JXBC55 optional outdoor cover accessory may be ordered for installation of blower and motor assembly on an outside wall.

Installation Rules

- Never vent a cooktop into an interior space - always to the outdoors.
- The updraft grill requires an overhead vent with at least 300 CFM.
- DO NOT install an updraft grill component next to a downdraft vent.
- DO NOT install a downdraft vent behind a cooktop.
- DO NOT install a gas or grill cooktop where the knobs are between the heated area and the downdraft vent.

Cabinetry

Component Cooktop System

Installation Location

- Whenever possible, avoid placing cabinetry directly above the cooking surface.
- If cabinetry is used above the cooking surface:
 - Use cabinets no more than 13" deep.
 - Maintain 30" minimum clearance between cooktop(s) and unprotected cabinets directly above the cooktop.
 - If clearance is less than 30", protect cabinet bottoms with flame-retardant millboard at least 1/4" thick or gypsum board at least 3/16" thick covered with 28 gauge sheet steel or .02" thick copper.
 - Clearance between cooktop and protected cabinetry must not be less than 24".
 - Working areas next to the cooktops should have 18" minimum clearance between the countertop and the cabinet bottom.

EXCEPTION: Installation of a listed microwave oven or cooking appliance over the cooktop(s) shall conform to the installation instructions packed with that appliance.

- Installation must conform with local codes.

Clearances:

- When installed electric components require the following clearances:
 - 2" min. from front of cooktop to front edge of countertop,
 - 1" min. from back of cooktop to rear wall,
 - 1" min. from side of cooktop to side wall.
- Gas components require:
 - 2" min. from back of cooktop to rear wall,
 - 2" min. from side of cooktop to side wall.

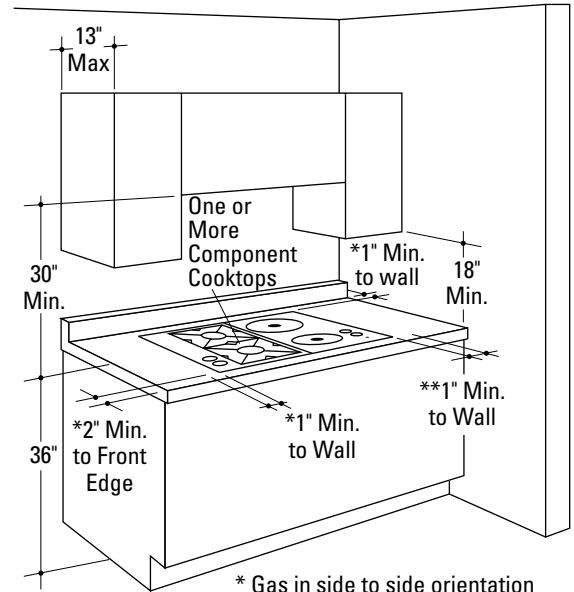

* Gas in side to side orientation requires 2" min. to rear wall.

** Gas requires 2" min. to side wall.

Cabinetry

Component Cooktop System

Tools & Materials Required

(Not supplied)

- Carpenter's square
- Measuring tape
- Saw
- #2 Phillips head screwdriver bit socket
- Phillips screwdriver
- 1/4" nutdriver
- 5/16" nutdriver
- 7/16" and 5/16" socket and ratchet wrench
- Pencil
- Scissors
- Level
- Hole saw
- 6" 90° elbow
- Duct work to suit the installation.

For Gas Components:

- Pipe wrench
- Gas line to reach installation location
- Gas resistant pipe joint sealant.
- Manual gas line shut-off valve
- 3/4" NPT x 3/4" I.D. or 1/2" NPT x 1/2" I.D. flare union adapter
- 1/2" NPT x 3/4" I.D. or 1/2" I.D. flare union adapter
- 5 foot AGA certified flexible metal appliance connector, 3/4" x 1/2" I.D. to match gas supply line.
- If required by local codes, use solid pipe with fittings.

NOTE: Use new flexible line. DO NOT use old, previously used flexible line.

Cutout Information

4" Minimum Between Cutouts

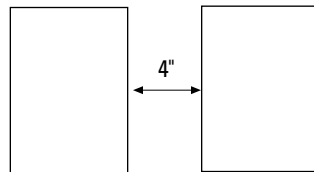

Front to Back Orientation

4" Minimum Between Cutouts

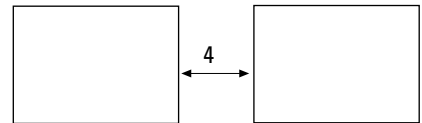

Side to Side Orientation

- Minimum clearance is 4" between cooktops in separate cutouts. This clearance does not apply when multiple component cooktops are installed in one cutout.

NOTE: Do not install a downdraft vent in a side to side orientation behind a gas or radiant component. This would require the user to reach over a heated surface to access the control.

Find Dimension A in chart below and on the following page.

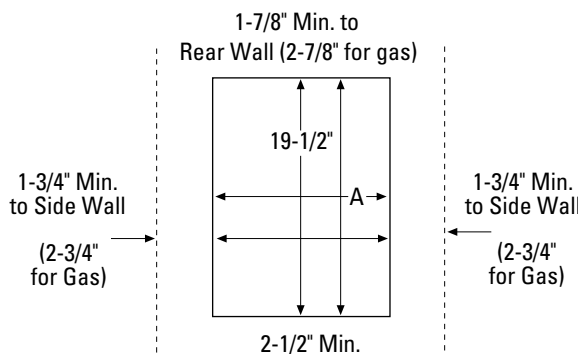

Front to Back Orientation

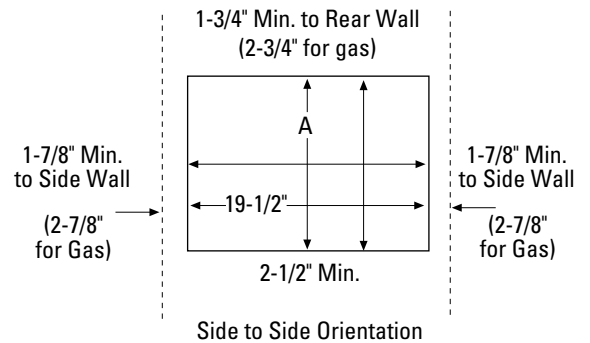

Side to Side Orientation

Cut the opening as shown above. Measure carefully when cutting countertop, making sure sides are parallel and front and rear cuts are perpendicular to sides.

- The front and rear of the opening must clear support rails of the cabinet.
- The cutout depth (front to back) is 19-1/2" for all components.



	A
Radiant	14-1/2"
Gas	14-1/2"
Updraft grill	15-3/8"
Downdraft Grill	20-3/4"
Downdraft Vent	5-1/8"

Cabinetry

Component Cooktop System

Cutout Information (Continued)

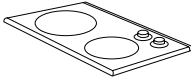
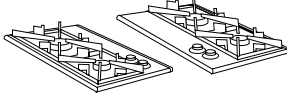
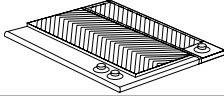
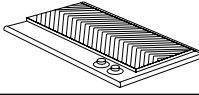
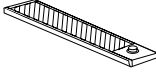
If your configuration is not shown in the previous charts, use the following chart to calculate your cutout size. For each of the following components, add the dimensions given.

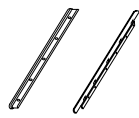
Component/Connector	Model/Name	Width	Quantity	Sub Total Width
	ZEW145 Radiant Cooktop Component	14-1/2"		
	ZGW124 ZGW125 Gas Component	14-1/2"		
	ZEW166 Downdraft Grill Component	20-3/4"		
	ZEW155 Updraft Grill Component	15-3/8"		
	ZEW176 Downdraft Vent Component	5-1/8"		
	Joiner Strip Connection between two cooktops (including updraft grill and non-vent side of downdraft grill)	3/4"		
	Downdraft Joiner Strip Connection between cooktop and downdraft vent or vent side of downdraft grill	1/4"		
	Cooktop and Downdraft Vent End Caps Provide finished look to component cooktop arrangement. Do not count as part of cutout width.	0"		0"
Total Cutout Width				_____

Cutout Information: Multiple Components Example

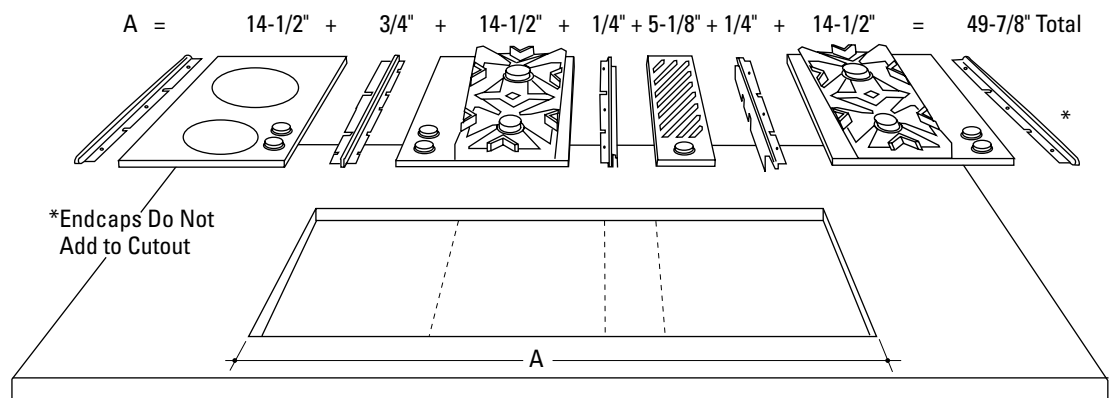















































Cabinetry

Component Cooktop System

Cutout information: multiple component units

If multiple components will be attached together, determine dimension A from the following:

Unit 1	Unit 2	Unit 3	Unit 4	Unit 5	A
 Radiant	 Radiant				29-3/4"
 RH Gas	 RH Gas				
 LH Gas	 LH Gas				
 Radiant	 Updraft Grill				30-5/8"
 RH Gas					
 LH Gas					
 Updraft Grill	 Updraft Grill				31-1/2"
 Downdraft Vent*	 Radiant				19-7/8"
	 RH Gas				
 Downdraft Grill	 Radiant				35-1/2"
	 RH Gas				
 Radiant	 Downdraft Vent*	 Radiant			34-5/8"
 LH Gas		 RH Gas			
 Downdraft Grill	 Radiant	 Radiant			50-3/4"
	 RH Gas	 RH Gas			
		 LH Gas			
 Radiant	 Downdraft Vent*	 Radiant	 Downdraft Vent*	 Radiant	54-3/4"
 Downdraft Vent*	 Radiant	 LH Gas	 Downdraft Vent*	 Radiant	55-1/4"
	 RH Gas			 RH Gas	
 Radiant	 Downdraft Vent*	 Downdraft Grill*	 Radiant		55-5/8"
 LH Gas			 RH Gas		

*See "Venting rules" concerning placement of knobs in relation to downdraft vent. If your configuration is not shown, refer to following page.

Ductwork

Component Cooktop System

Venting Options

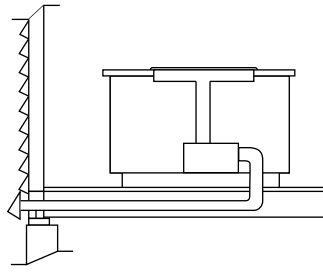

Through Floor Between Joists

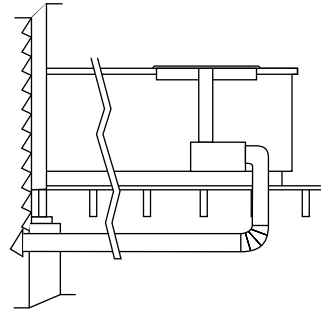

Through Floor & Under Joists

Multiple cooktops and downdraft vent units may be used in a single arrangement.

- Plan the route for venting exhaust to the outdoors.
- Ductwork must be vented to outdoors - never to a crawl space, attic or other enclosed space.
- Duct should be located between floor joists or wall studs whenever possible.
- Blower and motor assembly can be installed on an outside wall. JXBC55 optional outdoor cover accessory is required and must be ordered with each downdraft venting unit.
- Every downdraft vent and downdraft grill must have it's own, separate duct run.

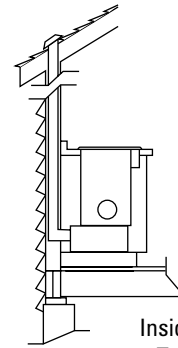

Inside Wall To Roof

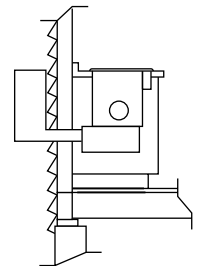

Direct To Outdoors With JXBC55 Mounted On Outside Wall

Ductwork Advance Planning

- Use the shortest and straightest duct run possible.
 - Duct run for Downdraft Grill Component, ZEW166, should not exceed equivalent length of 100 feet.
 - Duct run for Downdraft Vent, ZEW176, should not exceed equivalent length of 150 feet.
 - Refer to “Duct Fittings” chart to calculate equivalent length for various duct configurations.

- The downdraft blower system is designed for use with 3-1/4" x 10" ductwork. It can be transitioned to 6" round.
- Ductwork **MUST** be vented to the outside – never into a crawl space, attic or other enclosed space.

Optional Ductwork Arrangement

- 6" PVC duct should be used when installing under a concrete slab.
- Use recommended wall caps with damper. Do not use laundry type wall caps.
- Ductwork must be vented to the outside.
- Each cooktop blower system requires a separate duct system.

NOTE: Local building code must be followed for installation and in specifying approved type and schedule of PVC duct used.

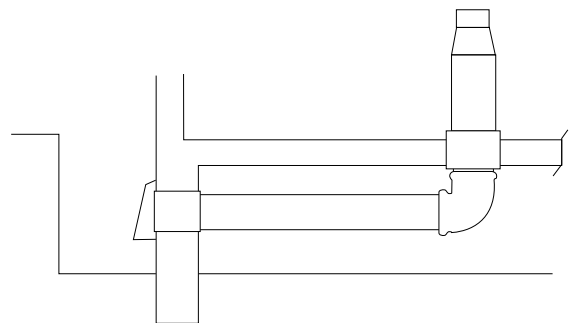

Ductwork

Component Cooktop System

Determine Ductwork Location

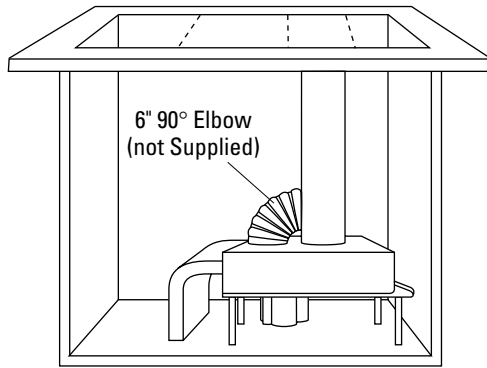

Discharge left side (not to scale)

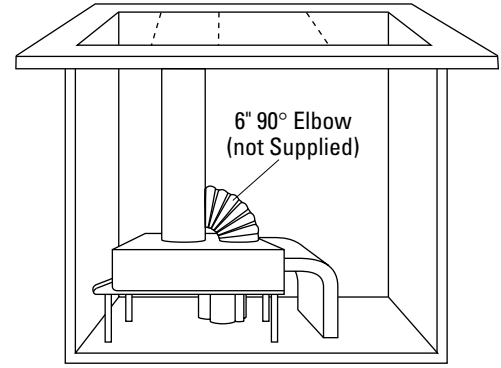

Discharge right side (not to scale)

To accurately locate the ductwork holes in the cabinet floor:

- Place all components into the cutout, arranged in the exact position they will be installed.
- Place a 90° elbow over the discharge outlet and into the blower motor assembly.
- Position the transition duct on the end of the blower motor assembly.
- Mark the location and remove the components and blower motor assembly.
- Cut holes and install ductwork connections.
- The discharge on the plenum is located on the left side. To change to the right side, remove 2 screws on each side of the plenum below the cooktop flange. Rotate the plenum and re-install screws.

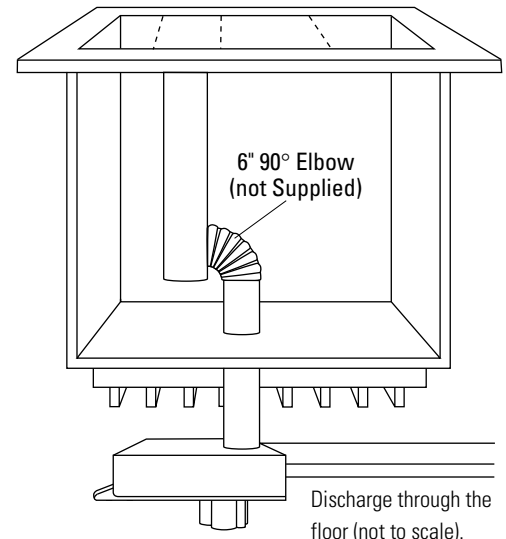

Install Blower Assembly

Install blower

- The blower can be mounted in the cabinet or under the floor. The blower will fit between floor joists on 16" centers.
- For installation where the blower is mounted inside the cabinet, attach the mounting supports to the bottom corners of the blower housing. (The motor is on the bottom side, the 6" round opening is the top side).
- If the blower is installed under the floor, attach the mounting supports to the top corners (the side with the 6" round opening).

NOTE: Do not drill additional holes in the blower.

Adjust mounting supports

- Adjust the height of the mounting supports by sliding the two halves up or down. With supports at desired length, install bolts and nuts into the supports.
- Secure the blower to the cabinet floor or between floor joist with screws provided.

Finalize Ductwork

- Install ductwork, making connections in the direction of airflow as shown.
- Secure all joints with sheetmetal screws.
- Wrap joints with duct tape for airtight seal.
- Install a wall cap with damper or roof cap at exterior opening.

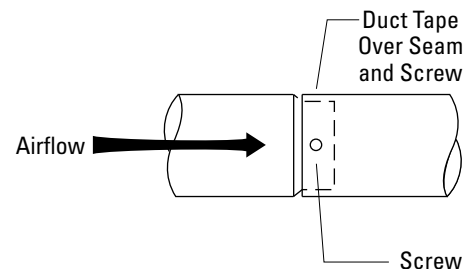

Ductwork

Component Cooktop System

Duct fittings

Use copies of this form to compute maximum permissable lengths for duct runs to outdoors.

ZEW166 Downdraft Grill
Component maximum equivalent length is **100 feet.**

ZEW176 Downdraft Vent
Component maximum equivalent length is **150 feet**

Note: Do not exceed maximum permissable equivalent lengths!











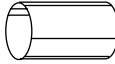
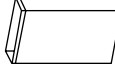

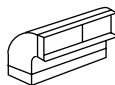
Flexible ducting:

If flexible metal ducting is used, all the equivalent length values in the table should be doubled. The flexible metal duct should be straight and smooth and extended as much as possible.

Do NOT use flexible plastic ducting.

CAUTION:

Any home ventilation system, such as a cooktop with a downdraft exhaust mechanism, may interrupt the proper flow of combustion air and exhaust required by fireplaces, gas furnaces, gas water heaters and other naturally vented systems. To minimize the chance of interruption of such naturally vented systems, follow the heating equipment manufacturer's guidelines and safety standards such as those published by NFPA and ASHRAE.

Duct Piece	Dimensions	Equivalent Length*	Quantity Used	Total Equivalent Length
	6" round, straight	1 ft. (per foot length)		
	3-1/4" x 10" straight	1 ft. (per foot length)		
	6" 90° elbow	15 ft.		
	6" 45° elbow	9 ft.		
	3-1/4" x 10" 90° elbow	15 ft.		
	3-1/4" x 10" 45° elbow	9 ft.		
	3-1/4" x 10" 90° flat elbow	20 ft.		
	6" round to 3-1/4" x 10" transition	1 ft.		
	3-1/4" x 10" to 6" round transition	5 ft.		
	6" round to 3-1/4" x 10" 90° elbow transition	5 ft.		
	3-1/4" x 10" to 6" round 90° elbow transition	15 ft.		
	6" round wall cap with damper	30 ft.		
	3-1/4" x 10" wall cap with damper	30 ft.		
	6" round roof cap	26 ft.		
	6" round roof vent	24 ft.		

* Actual length of straight duct plus duct fitting equivalent. Equivalent length of duct pieces are based on actual tests conducted by GE Evaluation Engineering and reflect requirements for good venting performance with any downdraft cooktop.

Total Duct Run _____

Gas and Electrical Supply

Component Cooktop System

Gas Supply Location

- Gas components are designed to operate on natural gas at 4" water column pressure. These cooktops are supplied with 1/2" NPT male gas connections. The connection for models with right hand controls is on the bottom right corner, and left hand control models on the left corner.
- Gas components cannot be converted to LP gas operation.
- Make gas connection through the rear wall, or on the cabinet floor at the rear.
- For rigid connection, locate pipe stub:
 - 4-7/16" from center line of appliance,
 - on the back wall, at least 12" below countertop,
 - on the floor, 2-1/2" forward of the back of the countertop cutout.

- For flexible connection, locate pipe stub on floor or back wall in a convenient location.
- Install a manual shut-off valve in the gas line in an easily accessible location.

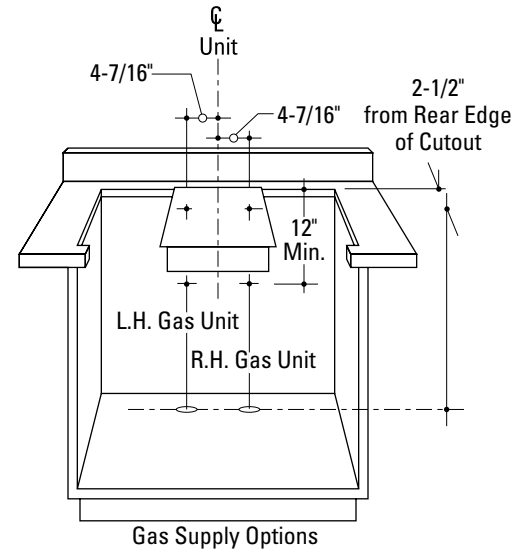

Important: 12" min. is specified to allow space for shut-off valve if supply is opted to enter from rear.

Note: Both left and right-controlled gas components are illustrated together in order to compare their supply rough-in locations.

Electrical Supply

The radiant component operates on 240/208 volt, 60 Hz. Updraft grill and downdraft grill components operate on 240 volt, 60 Hz. Gas and downdraft vent components operate on 120 volt, 60 Hz. from a separate junction box. A dedicated circuit, protected by a time delay fuse or circuit breaker is required for cooktops. The downdraft vent requires an appliance circuit with a time delay fuse or circuit breaker.

- If local codes permit, more than one cooktop can be used on the same branch circuit. See local codes or the National Electrical Code for circuit demand loads.

WARNING: DO NOT USE AN EXTENSION CORD WITH THESE APPLIANCES.

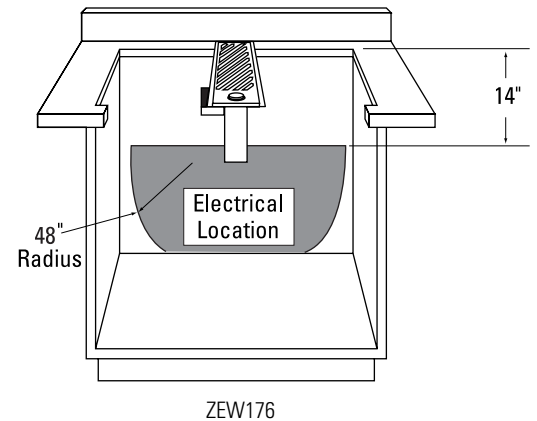
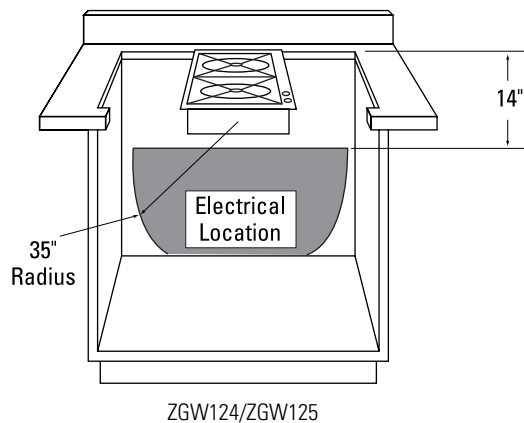
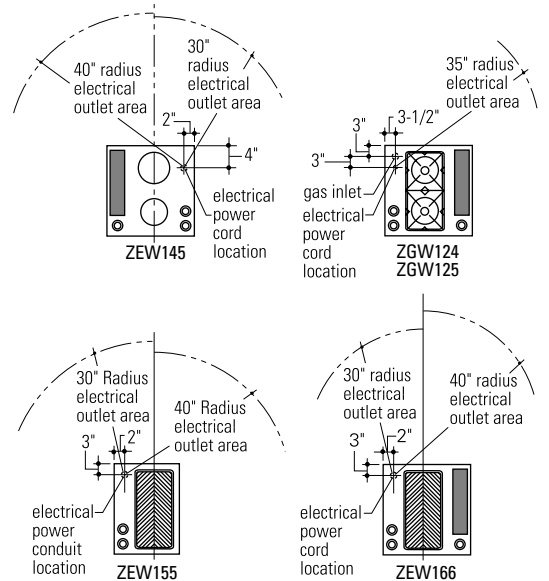

Installation

Component Cooktop System

Step **1**
*Apply
Gasket Strip*

Apply foam tape (supplied) on top surface of countertop along all edges of the cutout.

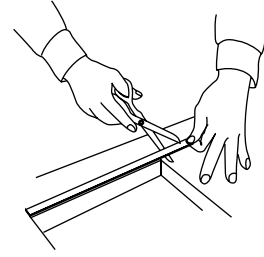

Step **2**
*Remove
Knobs,
Gates*

- Turn all control knobs to OFF position.
- Carefully remove knobs by lifting straight up.
- Remove all grates, burner caps and vent covers from components.
- Remove tape covering screw holes on the downdraft grill.

Step **3**
*Joining
Multiple
Cooktops*

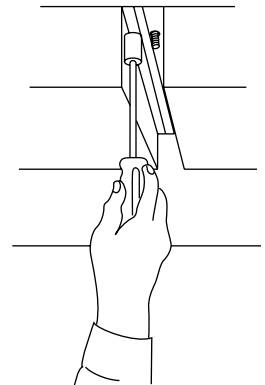
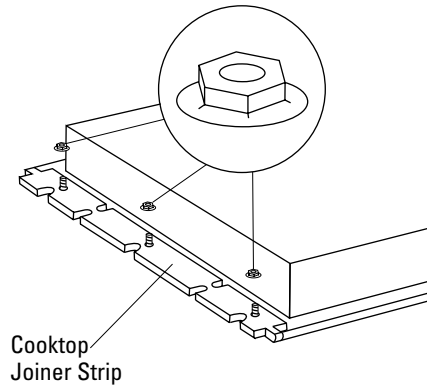
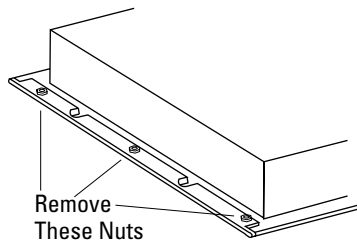

- Lay cooktops upside down on a clean flat work surface.
- Remove endcaps on sides to be joined by removing three nuts with a 5/16" nutdriver. Discard nuts.
- Attach joiner strip to first cooktop by tightening flanged nuts (supplied) over the flanges.
- Place the two cooktops into the countertop cutout.
- Slide the cooktops together so that the slots in the joiner strip are engaged by the studs. There should be no gaps between cooktops and joiners. Press together firmly to assure a tight fit.
- Place flanged nuts in end of 5/16" nutdriver. Start nuts on studs and tighten from below.

Attach chassis support brace to equal-height cooktops

- When attaching gas to gas, gas to radiant, radiant to radiant or grill to grill, place support brace as shown.
- Remove one screw from the center of each cooktop chassis.
- Position brace and tighten screws.
- Repeat these steps for three cooktops.

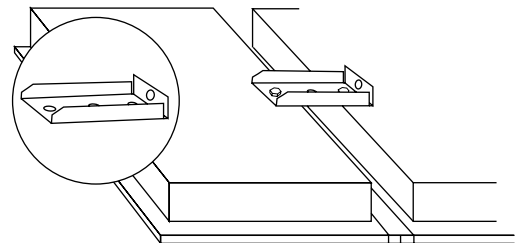

Installation

Component Cooktop System

Joining Multiple Cooktops (Continued)

Attach chassis support brace to different height cooktops

- When attaching grill to radiant or gas, place the support brace as shown.
- Remove one screw from the center of each cooktop chassis.
- Position brace and tighten screws.
- Repeat these steps for three cooktops.

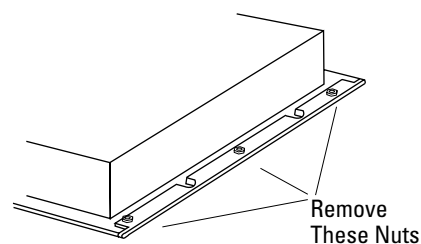
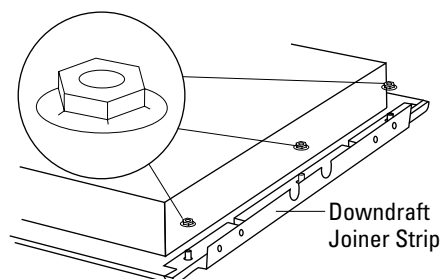
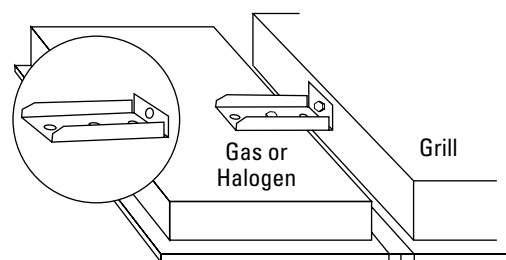

Joining Cooktop to Downdraft Vent

- Remove all grates, knobs, burner caps and drip pans.
- Lay cooktop upside down.
- Remove endcap on side of cooktop to be joined by removing three nuts with a 5/16" nutdriver.

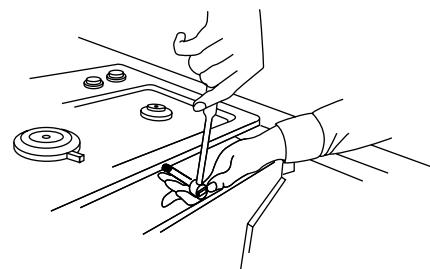

Important: Pre-tap holes in downdraft joiner and endcaps by driving supplied screws through holes and then backing out before installation. This will make the joining process easier.

- Replace endcap with downdraft joiner strip using the same three nuts.
 - If the vent is to be installed at the end of the countertop opening, attach downdraft endcap to that side.
- Place the downdraft vent and cooktop into the cutout.
- Remove two screws from the front of cooktop chassis. Drive the two screws into holes below the downdraft vent flange as shown. Use a phillips screwdriver bit socket.
- If downdraft vent is installed at the end of the cutout, secure the downdraft endcap to the countertop by driving two phillips head screws as shown.
- To finalize installation, proceed to “Securing cooktop(s) to countertop.”
- If additional cooktop(s) are to be installed, proceed to “Joining additional cooktop to downdraft vent or downdraft grill.”

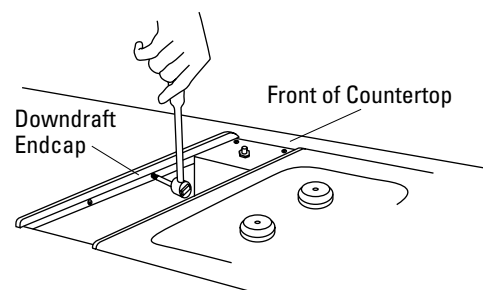

Installation

Component Cooktop System

Joining Multiple Cooktops (Continued)

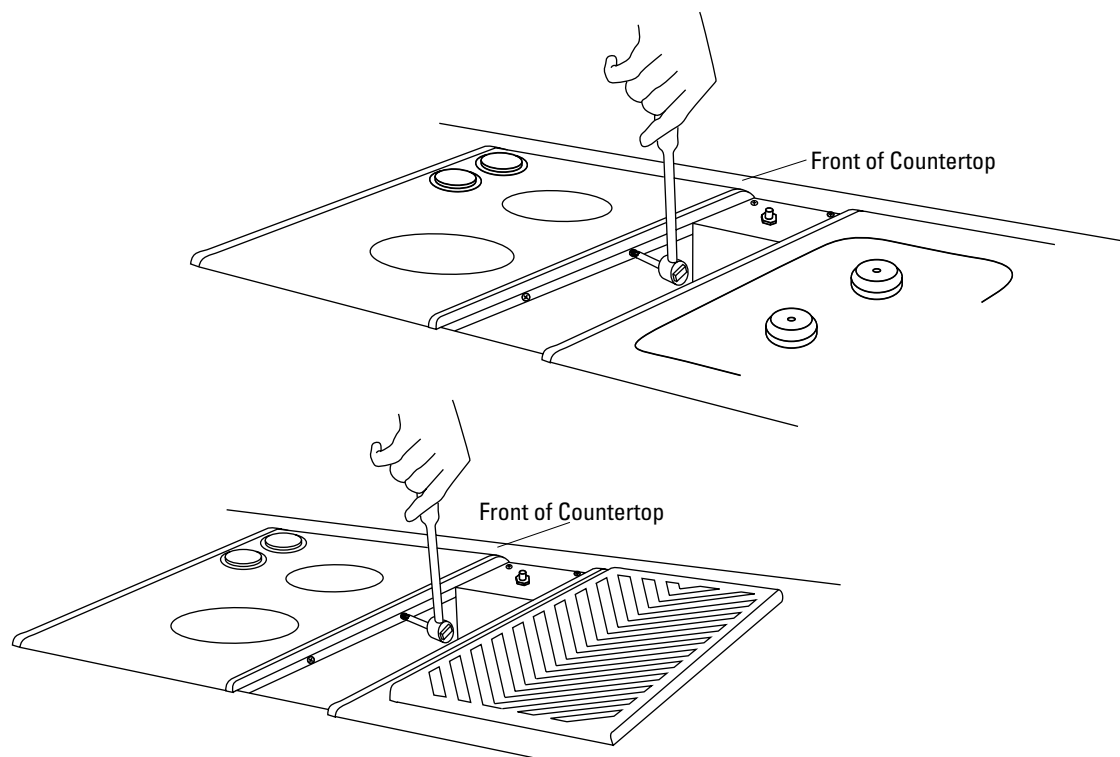

Joining additional cooktop to downdraft vent or to downdraft grill

- Remove endcap on the side of the next cooktop to be joined.
- Pre-tap holes in downdraft joiner and endcaps by driving supplied screws through holes and then backing out before installation. This will make the joining process easier.
- Attach downdraft joiner strip to cooktop.
- Place cooktop next to downdraft vent in the cutout.
- Drive two phillips head screws into pre-tapped holes. Use a phillips screwdriver bit socket.
- To install additional vent or cooktop(s), refer to “Joining Multiple Cooktops.”

Step 4

Secure Cooktop(s) to Countertop

- Loosen screws on hold-down brackets at each end of cooktop. Extend the bracket to reach the underside of the countertop. Tighten screws.
- Drive a long screw (2 lengths are provided) through the bracket until screw is tight against the bottom of the countertop.

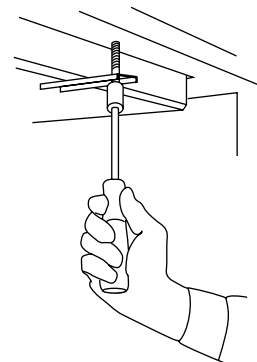

Installation

Component Cooktop System

Step 5

Connect Gas

- Install the supplied pressure regulator in gas supply line as close to the cooktop inlet as possible. Allowances for ventilation ducting may be required.
 - The regulator should be installed with the arrow pointing in the direction of gas flow.
- Install a manual gas shut-off valve where it will be easily reached. Be sure the user knows where and how to shut off the gas supply.
- Appropriate flare union adapters are required at each end of a flexible connector.
- Turn on the gas and check for leaks. Use a liquid leak detector at all connections in the system. A pressure test fitting is located on the pressure regulator.

NOTE: If local codes permit, use 5 foot AGA-certified flexible metal gas supply line. 3/4" or 1/2" I.D. to match gas supply line.

Do not use old, previously used flexible line.

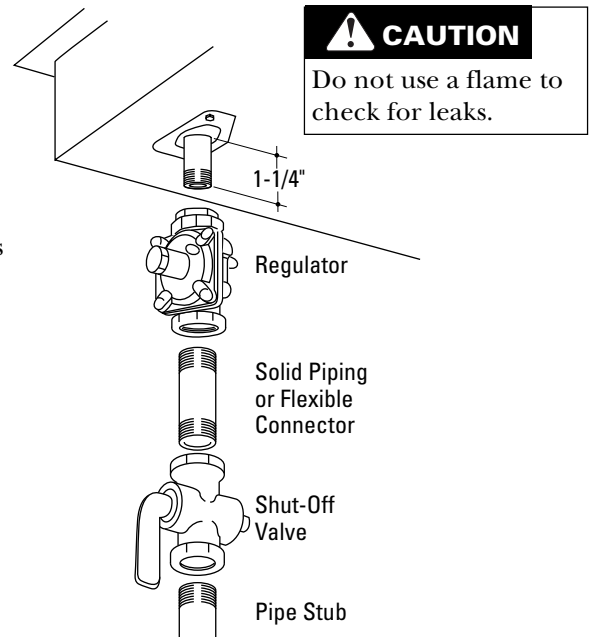

Step 6

Connect Electrical

Connect electrical to downdraft vent

- Connect the 3-pin plastic plug from the blower/motor assembly to the 3-pin plastic socket on the underside of the vent controls.
- Fasten the wire box on the conduit over the plug and onto the bottom of the control box with screws provided.

The blower conduit is long enough to reach the vent connection when installed in the cabinet below. The conduit will also reach some blower installations below the cabinet floor.

- If the blower conduit is not long enough to reach the vent connection, the leads can be extended.

To add conduit length:

- Install an appropriate junction box near the blower.
- Remove the wire box from the end of the blower conduit.
- Cut the leads approximately 3" from the plug.
- Cut a length of electrical cable to reach the junction box. Use 14 gauge min. electrical cable (or conform to local codes).
- Attach the wire box and plug to one end of the cable. Connect opposite end of cable to blower leads in the junction box.

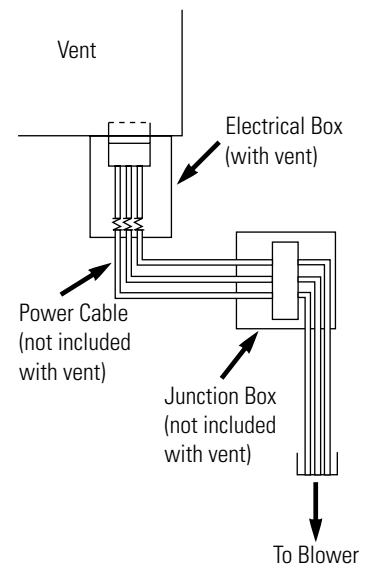
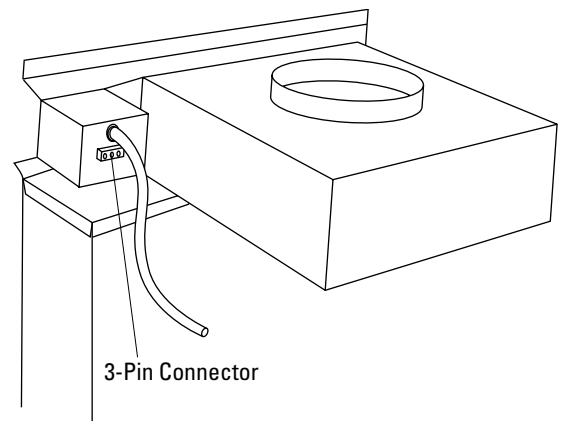

Installation

Component Cooktop System

Step 6

Connect Electrical (Continued)

3-Conductor branch circuit:

- Connect red lead to branch circuit red lead.
- Connect black lead to branch circuit black lead.
- Connect bare or green conductor and white lead * of the cooktop to branch circuit neutral lead, which is white or gray.

3-Conductor Branch Circuit

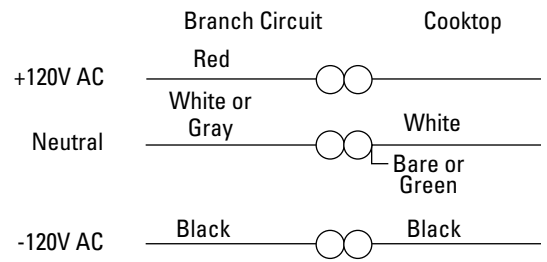

4-Conductor branch circuit:

- Connect red lead to branch circuit red lead.
- Connect black lead to branch circuit black lead.
- Break connection between cooktop white lead to bare or green conductor.
- Connect cooktop white lead* to branch circuit neutral lead, which is white or gray.
- Ground unit by connecting bare conductor of cooktop to branch circuit bare or green lead (ground lead).

4-Conductor Branch Circuit

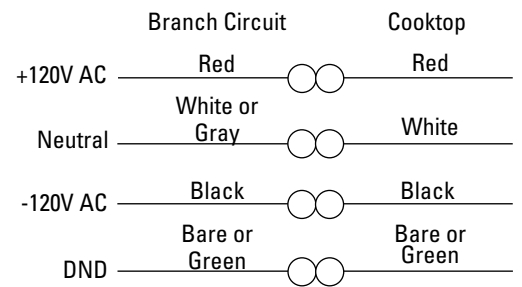

The frames of these appliances are grounded to neutral.

* Updraft grill has no white neutral wire. Connect only black, red and bare wires as shown.

Electrical Power Requirements

Model	Voltage	Frequency	AMPS	KW
ZGW124	120	60 Hz	1.0	—
ZGW125	120	60 Hz	1.0	—
ZEW145	208	60 Hz	11.0	2.3
ZEW145	240	60 Hz	12.7	3.0
ZEW155	240	60 Hz	7.3	1.8
ZEW166	240	60 Hz	13.5	3.3
ZEW176	120	60 Hz	1.8	—

Installation

Component Cooktop System

Finalize Installation

Install downdraft vent filter

- Place filter into the opening and on top of the supports.
- Place grille over the filter.

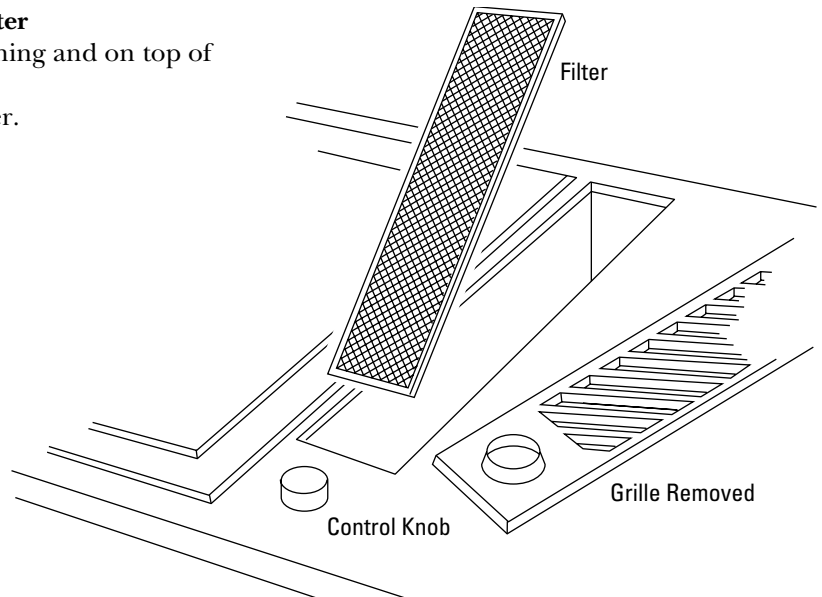

Electric Components:

Push in and turn each knob to high position. Make sure each element heats up.

Gas Components:

(Electrical connections should be complete).

- Plug power cord into outlet.
- Assemble burner(s) as shown.
- Check for proper ignition:
 - Push in control knob and turn 90° to HIGH position.
- First test may require some time, while air is flushed out of the gas line.
 - Turn knob to OFF.
 - Repeat the procedure for each burner.

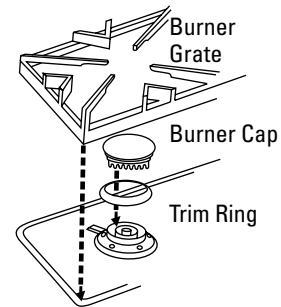

CAUTION Do not operate the burners until all burner parts are in place.

Note: While performing installations described in this book, safety glasses or goggles should be worn.

For Monogram local service in your area, call 1-800-444-1845.

NOTE: Product improvement is a continuing endeavor at General Electric. Therefore, materials, appearance and specifications are subject to change without notice.



General Electric Company
Louisville, KY 40225

Pub. No. 49-8834-2

Dwg. No. 164D3333P076

Printed in USA

(N.D. 237) 8/01

953-0559-000 - Rev. 1