



MICROWAVE OVEN

Use and Care Guide

HORNO DE MICROONDAS

Manual de Uso y Cuidado

Models/Modelos 721.69113

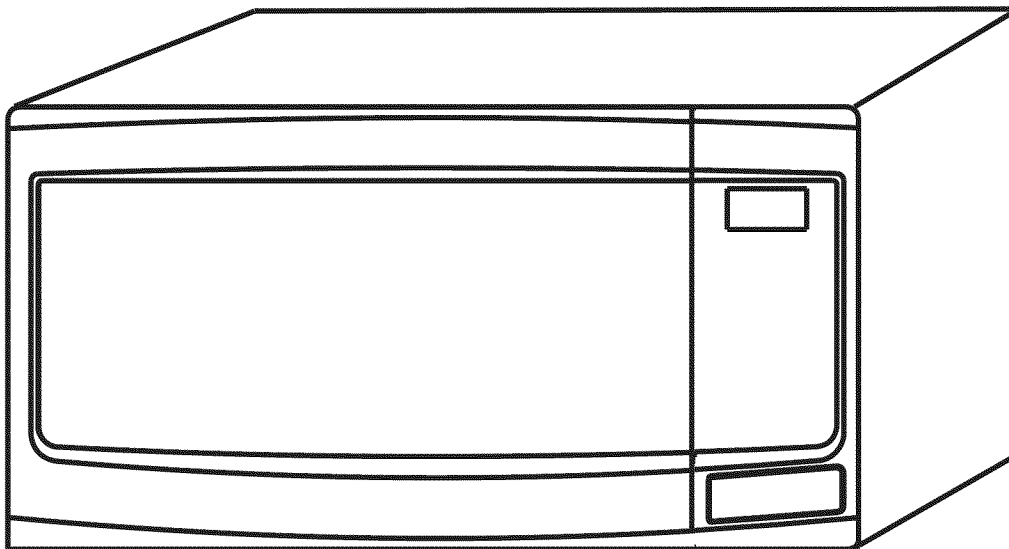

ENGLISH

ESPAÑOL

Sears, Roebuck and Co., Hoffman Estates, IL 60179 U.S.A.

P/NO.: MFL62132402

www.sears.com

TABLE OF CONTENTS

WARRANTY	3	Clock	10
SAFETY	4-5	Kitchen Timer.....	10
Precautions To Avoid Possible Exposure		Child Lock.....	10
To Excessive Microwave Energy	4	Add Minute.....	11
Grounding Instructions.....	4	Timed Cooking.....	11
Important Safety Instructions.....	5	Multi-Stage Cooking.....	12
UNDERSTANDING YOUR		Microwave Power Levels	12
MICROWAVE OVEN	6-9	Quick Touch Cooking	13
Specifications.....	6	Quick Touch Cooking Table	13
Installation.....	6	Auto Defrost.....	14
Parts And Accessories	7	Express Defrost	14
Control Panel.....	7	Auto Defrost Table	14
Cookware Guide	8	Cooking Tips.....	15-16
Tips For Microwave Cooking	9	TROUBLESHOOTING	17-19
Cleaning.....	9	Questions And Answers	17-18
USING YOUR MICROWAVE OVEN	10-16	Before Calling For Service.....	19
		Master Protection Agreements	38
		Service Numbers	Back cover

WARRANTY

Kenmore Full Warranty

When installed, operated and maintained according to all supplied instructions, if this appliance fails due to a defect in material and workmanship within one year from the date of purchase, return it to any Sears store or other Kenmore outlet in the United States for free replacement.

This warranty applies for only 90 days from the date of purchase if this appliance is ever used for other than private family purposes

This warranty covers only defects in material and workmanship. Sears will NOT pay for:

1. Expendable items that can wear out from normal use, including but not limited to filters, belts, light bulbs, and bags.
2. A service technician to instruct the user in correct product installation, operation or maintenance.
3. A service technician to clean or maintain this product.
4. Damage to or failure of this product if it is not installed, operated or maintained according to all instructions supplied with the product.
5. Damage to or failure of this product resulting from accident, abuse, misuse or use for other than its intended purpose.
6. Damage to or failure of this product caused by the use of detergents, cleaners, chemicals or utensils other than those recommended in all instructions supplied with the product.
7. Damage to or failure of parts or systems resulting from unauthorized modifications made to this product.

This warranty applies only while this appliance is used in the United States or Canada.

This warranty gives you specific legal rights, and you may also have other rights which vary from state to state.

Sears, Roebuck and Co., Hoffman Estates, IL 60179

Sears Canada Inc., Toronto, Ontario, Canada M5B 2B8

SAFETY

PRECAUTIONS TO AVOID POSSIBLE EXPOSURE TO EXCESSIVE MICROWAVE ENERGY

- DO NOT attempt to operate this oven with the door open, since open-door operation can result in harmful exposure to microwave energy. **It is important not to defeat or tamper with the safety interlocks.**
- DO NOT operate the oven if it is damaged. It is particularly important that the oven door close properly and that there is no damage to the:
 - door (bent),
 - hinges and latches (broken or loosened),
 - door seals and sealing surfaces.
- DO NOT place any object between the oven front face and the door or allow soil or cleaner residue to accumulate on sealing surfaces.
- THE OVEN should not be adjusted or repaired by anyone except properly qualified service personnel.

GROUNDING INSTRUCTIONS

This appliance must be grounded! If an electrical short circuit occurs, grounding reduces the risk of electric shock by providing an escape wire for the electric current. This appliance

is equipped with a cord having a grounding wire with a grounding plug. Insert the plug into an outlet that is properly installed and grounded.

WARNING

If you use the grounding plug improperly, you risk electric shock.

Ask a qualified electrician or the Sears Service Department if you do not understand the grounding instructions or if you are not certain whether the appliance is properly grounded.

This appliance has a short power supply cord to reduce the risk of anyone tripping over or becoming entangled in the cord. You may use an extension cord if you are careful.

If you use an extension cord, be sure that:

- The extension cord has the same electrical rating as the appliance.
- The marked rating of the extension cord shall be equal to or greater than the electrical rating of the appliance.
- The extension cord is a grounding-type 3-wire cord.
- The extension cord does not drape over a countertop or tabletop, where it can be pulled on by children or tripped over accidentally.
- The electrical cord is dry and not pinched or crushed in any way.

NOTE: This oven draws 12.5 amperes at 120 volts, 60 hz.

ELECTRONIC INTERFERENCE

1. Microwave oven operation may interfere with TV, phone, or radio reception.
2. When there is interference, it may be reduced or eliminated by taking the following measures:
 - a. Clean the door and the sealing surfaces of the oven.
 - b. Reorient the receiving antenna of radio or TV.
 - c. Relocate the microwave oven in relation to the TV, phone, or radio.
 - d. Move the microwave oven away from the receiver.
 - e. Plug the microwave oven into a different outlet so the microwave oven and receiver are on different branch circuits.

IMPORTANT SAFETY INSTRUCTIONS

The safety instructions below will tell you how to use your microwave oven to avoid harm to yourself or damage to your oven.

⚠ WARNING — To reduce the risk of burns, electric shock, fire, injury to persons, or exposure to excessive microwave energy:

1. **Read all the instructions before using your microwave oven.**
2. **Do not allow children to use this oven without close supervision!**
3. Read and follow the specific **PRECAUTIONS TO AVOID POSSIBLE EXPOSURE TO EXCESSIVE MICROWAVE ENERGY** found on page 4.
4. **Do not tamper with the built-in safety switches on the oven door!** The oven has several built-in safety switches to make sure the power is off when the door is open.
5. **When cleaning the door and the surfaces that touch the door, use only mild, nonabrasive soaps or detergents and a sponge or soft cloth.**
6. **If your oven is dropped or damaged,** have it thoroughly checked by a qualified service technician before using it again.
7. **To avoid a fire hazard:**
 - a) **Do not overcook foods.** It can cause a fire in the oven.
 - b) **Do not use recycled paper products in your oven.** They can contain particles that can cause arcing or may ignite.
 - c) **Do not overcook potatoes.** Overcooking could cause a fire.
 - d) **Do not store combustible items** (bread, cookies, etc.) in the oven because if lightning strikes the power lines, it may cause the oven to turn ON.
 - e) **Do not use wire twist-ties in the oven.** Be sure to remove them before placing the item in the oven.
 - f) **Do not use the cavity for storage purposes.** Do not leave paper products, cooking utensils, or food in the cavity when not in use.
8. **If a fire should start:**
 - a) **Keep the oven door closed.**
 - b) **Turn the oven off.**
 - c) **Disconnect the power cord or shut off the power at the fuse or circuit breaker panel.**
9. **Do not use this oven for commercial purposes.** This microwave is made for household use only.
10. **Install or locate this appliance in accordance with the provided installation instructions.**
11. **To avoid electric shock:**
 - a) **This appliance must be grounded!** Connect it only to a properly grounded outlet. (See the Grounding Instructions on page 4.)
 - b) **Do not operate this appliance if it has a damaged cord or plug,** if it is not working properly, or if it has been damaged or dropped.
 - c) **Do not immerse the electrical cord or plug in water.**
 - d) **Keep the cord away from heated surfaces.**
 - e) **This appliance should be serviced only by qualified service personnel**
12. Liquids such as water, coffee, or tea are able to be overheated beyond the boiling point without appearing to be boiling due to surface tension of the liquid. Visible bubbling or boiling when the container is removed from the microwave oven is not always present. **THIS COULD RESULT IN VERY HOT LIQUIDS SUDDENLY BOILING OVER WHEN THE CONTAINER IS DISTURBED OR WHEN A SPOON OR OTHER UTENSIL IS INSERTED INTO THE LIQUID.** To reduce the risk of injury to persons:
 - 1) Do not overheat the liquid.
 - 2) Stir the liquid both before and halfway through heating it.
 - 3) Use extreme care when inserting a spoon or other utensil into the container once heating has begun.
 - 4) Do not use straight-sided containers with narrow necks.
 - 5) After heating, allow the container to stand in the microwave oven for a short time before removing the container.
13. **Keep the glass tray and the turntable roller rest in the oven when you are cooking.**
14. **Do not use the oven outdoors. Do not store the oven outdoors.**
15. **Do not use this product near water.**
 - For example, near a kitchen sink, in a wet basement, near a swimming pool or similar location.
16. **Do not cover or block any openings in the oven.**
17. **Do not run the microwave oven empty.**
18. **Do not let the cord hang over the edge of a table or counter.**
19. **Do not heat glass turntable excessively.**
 - Do not cook bacon directly on the glass turntable.
 - Do not allow the gray film on special microwave cooking packages to touch the glass turntable. Put the package on a microwave-safe dish.
 - Keep a browning dish at least 3/16 in. (.5 cm) above the glass turntable. If you use the browning dish incorrectly, you could break the glass turntable.
20. **Be careful not to chip or scratch the edges of the turntable.** Chips or scratches may cause the turntable to break during use.
21. Some items (for example, whole eggs, sealed containers and closed glass jars) are able to explode and should not be heated in this oven.
22. **Use this appliance only for its intended use as described in this manual.** Do not use corrosive chemicals or vapors in this appliance. This type of oven is specifically designed to heat, cook, or dry food. It is not intended for industrial or laboratory use.

SAVE THESE INSTRUCTIONS!

UNDERSTANDING YOUR MICROWAVE OVEN

SPECIFICATIONS

Power Supply	120V AC, 60 Hz
Rated Power Consumption	1,500 W
Microwave Output	*1,100 W
Rated Current	13.0 A
Overall Dimensions(WxHxD)	19 ^{13/16} " x 11 ^{1/4} " x 16 ^{3/4} "
Oven Cavity Dimensions(WxHxD)	14 ^{1/16} " x 8 ^{7/8} " x 13 ^{1/4} "
Capacity of Oven Cavity	1.1 Cu. Ft.

*IEC 60705 RATING STANDARD

Specifications subject to change without prior notice.

INSTALLATION

Carefully remove your Kenmore microwave oven from the shipping carton. Be sure to remove all packing materials from the oven cavity before use.

A. Circuits

For safety purposes this oven must be plugged into a 20-amp circuit. No other electrical appliances or lighting circuits should be on this line. If in doubt, consult a licensed electrician.

B. Placement of the Oven

Your microwave oven can be placed easily in your kitchen, family room, or anywhere else in your home. Place the oven on a flat surface such as a kitchen countertop or a specially designed microwave oven cart at least 39.4 in. (100 cm) from the floor. Do NOT place your microwave oven over a range, cooktop, or other heat-producing appliances. Free airflow around the oven is important. Allow at least 4 in. (10 cm) of space at the top, sides, and back of the oven for proper ventilation.

C. Turntable Installation

Place the turntable roller rest in the circle on the oven floor and then place the glass turntable on the turntable roller rest.

NOTES:

- Never place the glass turntable in the oven upside down. Blocking the air inlet and/or outlet openings can damage the oven.
- Never operate the oven without the turntable in place.

ENGLISH

INSTALLATION CLEARANCES

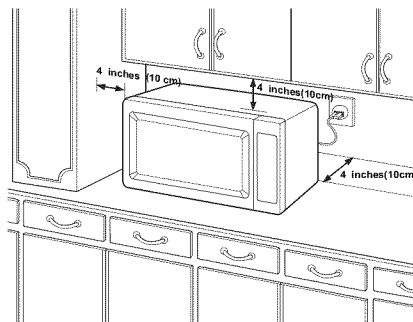

WARNING

To reduce the risk of fire or electric shock, do not install closer than 4 inches to side and back wall.

UNDERSTANDING YOUR MICROWAVE OVEN

PARTS AND ACCESSORIES

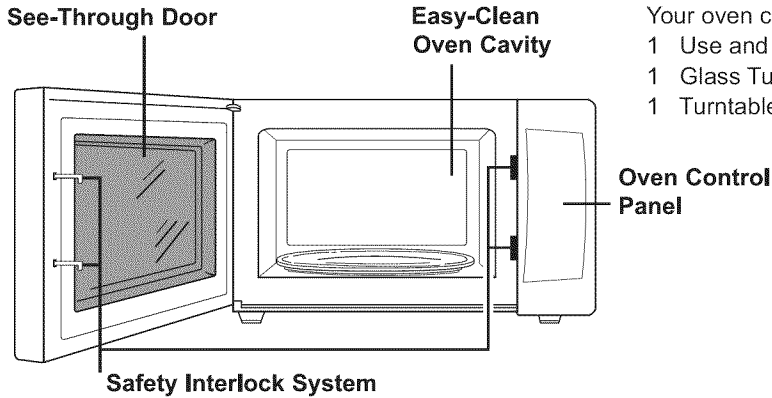

Your oven comes with the following accessories:

- 1 Use and Care Guide
- 1 Glass Turntable
- 1 Turntable Roller Rest

Glass Turntable

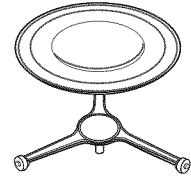

Turntable
Roller Rest

CONTROL PANEL

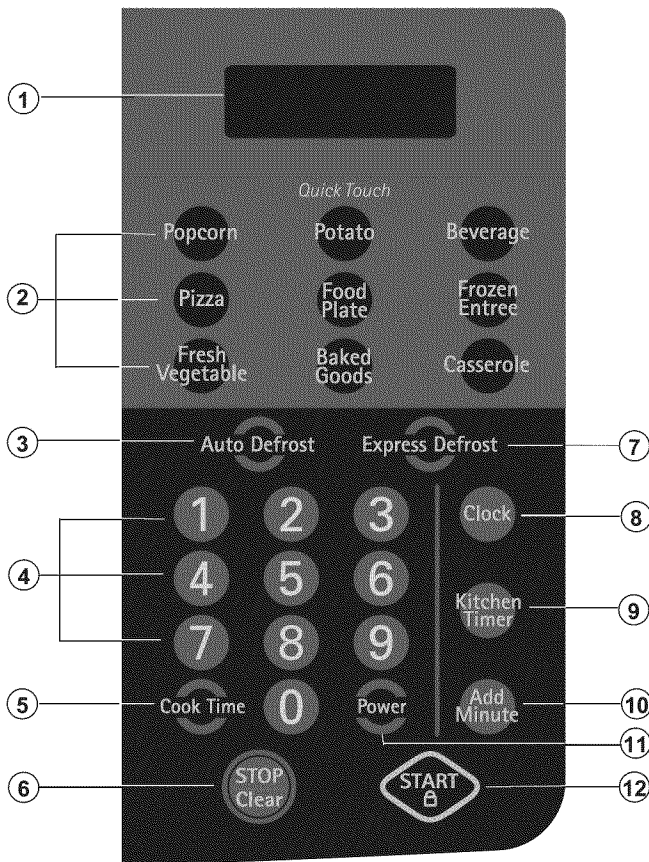

1. **DISPLAY.** The Display includes a clock and indicators that tell you time of day, cooking time settings, and cooking functions selected.
2. **QUICK TOUCH COOKING.** These pads allow you to cook most of your favorite foods without having to select cooking times and power levels.
3. **AUTO DEFROST.** This pad is an accurate defrosting method for frozen meat, poultry and fish up to 6.0 lbs.
4. **NUMBER PADS.** Touch Number Pads to enter cooking time, power level, quantities, or weights.
5. **COOK TIME.** Touch this pad to set a cooking time.
6. **STOP/CLEAR.** Touch this pad to stop the oven or clear entries.
7. **EXPRESS DEFROST.** This pad provides you with the quick defrosting method for 1.0 pound frozen foods.
8. **CLOCK.** Touch this pad to enter the time of day.
9. **POWER.** Touch this pad to set a cooking power.
10. **ADD MINUTE.** Touch this pad to cook at 100% cook power for 1 minute to 99 minute 59 seconds.
11. **KITCHEN TIMER.** Touch this pad to use your microwave oven as a kitchen timer.
12. **START.** Touch this pad to start all entries (except the Quick Touch Sensor, Express Defrost, Auto Cook and Add Minute function which start automatically) and to turn Child Lock on or off.

UNDERSTANDING YOUR MICROWAVE OVEN

COOKWARE GUIDE

Most heat-resistant, non-metallic cookware is safe for use in your microwave oven. However, to test cookware before using, follow these steps:

1. Place the empty cookware in the microwave oven.
2. Measure 1 cup of water in a glass measuring cup and place it in the oven beside the cookware.
3. Microwave on 100% power for 1 minute. If the dish is warm, it **should not** be used for microwave cooking.

ENGLISH

USE	DO NOT USE
<p>Ovenproof Glass</p> <ul style="list-style-type: none"> • Glass treated for use in high-intensity heat includes utility dishes, bread dishes, pie plates, cake plates, liquid measuring cups, casseroles, and bowls without metallic trim. <p>China</p> <ul style="list-style-type: none"> • Bowls, cups, serving plates, and platters without metallic trim can be used in your oven. <p>Plastic</p> <ul style="list-style-type: none"> • When using plastic wrap as a cover, make sure that the dish is deep enough so the plastic wrap does not touch the food. As the food heats, it may melt the plastic wrap wherever the wrap touches the food. • Place plastic wrap loosely over the top of the dish and secure it by pressing the wrap to the sides of the dish. • Vent by turning back one corner of the plastic wrap. This will allow excess steam to escape. • Use plastic dishes, cups, semi-rigid freezer containers, and plastic bags only for short time cooking. Use these with care because the plastic may soften from the heat of the food. <p>Paper</p> <ul style="list-style-type: none"> • Microwave-safe paper towels, waxed paper, paper napkins, and paper plates with no metallic trim or design can be used in your oven. • Refer to the manufacturer's label for use of any paper product in the microwave oven. 	<p>Metal Utensil</p> <ul style="list-style-type: none"> • Metal shields food from microwave energy and produces uneven cooking. Avoid metal skewers, thermometers, or foil trays. • Metal utensils can cause arcing, which is a discharge of electric current. Arcing can damage your microwave oven. <p>Metal Decoration</p> <ul style="list-style-type: none"> • Do not use metal-trimmed or metal-banded dinnerware, casserole dishes, etc. <p>Centura™ Tableware</p> <ul style="list-style-type: none"> • The Corning Company recommends that you do not use Centura tableware and some Corelle™ closed-handle cups for microwave cooking. <p>Aluminum Foil</p> <ul style="list-style-type: none"> • Do not use large sheets of aluminum foil because they hinder cooking and may cause arcing. You may use small pieces of foil to shield poultry legs and wings. • Keep all aluminum foil at least 1 inch from the walls and door of the oven. <p>Wood</p> <ul style="list-style-type: none"> • Wooden bowls, boards, and baskets will dry out and may split or crack when you use them in the microwave oven. <p>Tightly Closed Containers</p> <ul style="list-style-type: none"> • Tightly closed cookware can explode. Be sure to leave an opening for steam to escape from covered cookware. <p>Brown Paper</p> <ul style="list-style-type: none"> • Do not use brown paper bags. They absorb heat and could burn. <p>Metal Twist Ties</p> <ul style="list-style-type: none"> • Always remove metal twist ties as they can become hot and cause a fire.

UNDERSTANDING YOUR MICROWAVE OVEN

TIPS FOR MICROWAVE COOKING

BROWNING

Meat and poultry with high fat content that are cooked for 10 or 15 minutes or longer will brown lightly. Foods cooked a shorter time can be brushed with a browning agent, such as Worcestershire sauce, soy sauce, or barbecue sauce.

COVERING

A cover traps heat and steam and causes the food to cook more quickly. Use a lid or microwave-safe plastic wrap with one corner folded back to vent the excess steam. Lids on glass casseroles can become hot during cooking. Handle carefully. Waxed paper will prevent the food from splattering in the oven and help retain heat. When warming bread items, use waxed paper, napkins, or paper towels. To absorb extra moisture, wrap sandwiches and fatty foods in paper towels.

SPACING

Arrange individual foods, such as baked potatoes, cupcakes, and hors d'oeuvres in a circle and at least 1 inch apart. This will help the food cook more evenly.

STIRRING

Stirring blends flavors and redistributes the heat in foods. Always stir from the outside toward the center of the dish. Food at the outside of the dish heats first.

TURNING

Large foods, such as roasts and whole poultry, should be turned so that the top and bottom cook evenly. Also turn over chicken pieces and chops.

CLEANING

Wipe the oven inside and outside with a soft cloth and a mild detergent solution. Then rinse and wipe dry. This should be done weekly or more often, if needed. Never use cleaning powders or rough pads. Excessive oil splatters on the inside top will be difficult to remove if left for many days. Wipe splatters with a wet paper towel, especially after cooking chicken or bacon.

REMOVABLE PARTS

The turntable and turntable roller rest are removable. They should be hand-washed in warm (not hot) water with a mild detergent and a soft cloth. Once they are clean, rinse well and dry with a soft cloth. Never use cleaning powders, steel wool, or rough pads.

ARRANGEMENT

Do not stack food. Arrange in a single layer in the dish for more even cooking. Because dense foods cook more slowly, place thicker portions of meat, poultry, fish, and vegetables toward the outside of the dish.

TESTING FOR DONENESS

Because foods cook quickly in a microwave oven, you need to test frequently for doneness.

STANDING TIME

Depending on density, food often needs to stand from 2 to 15 minutes either in or outside of oven to finish cooking after cooking power shuts off. Outside of oven, you usually need to cover food during standing time to retain heat. Stop cooking most foods when they are slightly underdone and they will finish cooking during standing time. The internal temperature of food will rise about 10°F during standing time.

SHIELDING

To prevent some portions of rectangular or square dishes from overcooking, you may need to shield them with small strips of aluminum foil to block the microwaves. You can also cover poultry legs and wing tips with foil to keep them from overcooking. **Always keep foil at least 1 inch from oven walls** to prevent arcing.

PIERCING

Pierce the shell, skin, or membrane of foods before cooking to prevent them from bursting. Foods that require piercing include yolks and whites of eggs, hot dogs, clams, oysters, and whole vegetables, such as potatoes and squash.

- The glass turntable may be cleaned at the sink. Be careful not to chip or scratch the edges as this may cause the turntable to break during use.
- The turntable roller rest should be cleaned regularly.

SPECIAL CARE

For best performance and safety, the inner door panel and the oven front frame should be free of food or grease buildup. Wipe often with a mild detergent; then rinse and wipe dry. Never use cleaning powders or rough pads.

After cleaning the control panel, touch STOP/CLEAR to clear any entries that might have been entered accidentally while cleaning the panel.







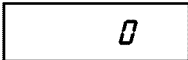

USING YOUR MICROWAVE OVEN

CLOCK

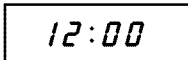
Example: To set the clock for 10:30.

Touch:

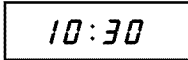
Display Shows:

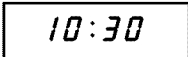
1.  
2.  
3.     
4.  

NOTE: This is a 12 hour clock.



CHILD LOCK

You can use this safety feature to lock the control panel so that children cannot use the oven when you do not want them to and when you are cleaning the oven.

To set CHILD LOCK:

Touch:

Display Shows:

1.  Time of day
2.  Touch and hold until "L" appears in the display. (approximately 4 seconds)

To cancel CHILD LOCK:

Touch:

Display Shows:

1.  Touch and hold until "L" disappears from the display. (approximately 4 seconds) Time of day.







KITCHEN TIMER

Your microwave oven can be used as a kitchen timer. You can set up to 99 minutes, 99 seconds.

Example: To set 3 minutes.

Touch:

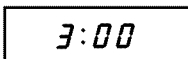
Display Shows:

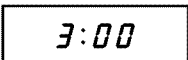
1.  
2.    
3.  

time counting down.



USING YOUR MICROWAVE OVEN

ADD MINUTE

A time-saving pad, this simplified control lets you quickly set and start microwave cooking at 100% power without the need to touch START.

Example: To cook for 2 minutes.

Touch: **Display Shows:**

1.  Time of day.
2.  Twice Time counting down and power 100

NOTE: If you touch **ADD MINUTE**, it will add 1 minute up to 99 min 59 seconds.









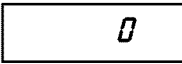

TIMED COOKING

This feature lets you program a specific cook time and power. For best results, there are 10 power level settings in addition to HIGH power (100%). Refer to the "Microwave Power Level Table" on page 11 for more information.

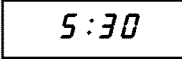
NOTE: If you do not select a power level, the oven will automatically cook at HIGH (100%) power.

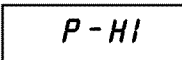
Example: To cook for 5 minutes, 30 seconds at 80% power.

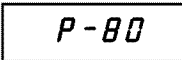
Touch: **Display Shows:**

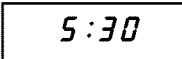
1.  
2.    
3.  
4.  
5.  

ENGLISH

USING YOUR MICROWAVE OVEN

MULTI-STAGE COOKING

For best results, some recipes call for different cook powers during different stages of a cook cycle. You can program your oven to switch from one power level to another for up to 3 stages.

Example: To set a 2-stage cook cycle.

Touch:

Display Shows:

1.  0

2.  3:00

to set a 3 minute cook time for first stage.

3.  P-HI

4.  to set an 80% cook power for the first stage. P-80

5.  0

6.  7:00

to set a 7 minute cook time for second stage.

7.  P-HI

8.  to set an 50% cook power for the second stage. P-50

9.  3:00

10. When the first stage is over, you will hear two short tones as the oven begins the second cook stage.

MICROWAVE POWER LEVELS

Your microwave oven has 10 cook power levels to let you cook or heat a wide variety of foods. Refer to the table below for suggestions:

Microwave Power Level Table

Power Level	Use
10 (High)	<ul style="list-style-type: none"> Boiling water. Making candy. Cooking poultry pieces, fish, & vegetables. Cooking tender cuts of meat. Whole poultry.
9	<ul style="list-style-type: none"> Reheating rice, pasta, & vegetables.
8	<ul style="list-style-type: none"> Reheating prepared foods quickly. Reheating sandwiches.
7	<ul style="list-style-type: none"> Cooking egg, milk, & cheese dishes. Cooking cakes, breads. Melting chocolate.
6	<ul style="list-style-type: none"> Cooking veal. Cooking whole fish. Cooking puddings & custard.
5	<ul style="list-style-type: none"> Cooking ham, whole poultry, & lamb. Cooking rib roast, sirloin tip.
4	<ul style="list-style-type: none"> Thawing meat, poultry, & seafood.
3	<ul style="list-style-type: none"> Cooking less tender cuts of meat. Cooking pork chops, roast.
2	<ul style="list-style-type: none"> Taking chill out of fruit. Softening butter.
1	<ul style="list-style-type: none"> Keeping casseroles & main dishes warm. Softening butter & cream cheese.
0	<ul style="list-style-type: none"> Standing time.

NOTE: You may program standing time as the final stage in multi-stage cooking.

USING YOUR MICROWAVE OVEN

QUICK TOUCH COOKING

Use this function to cook food without entering a cook time or power. Refer to the Quick Touch Cook Table below for more information.

Example: To cook a 3.5oz. bag of microwave popcorn.

Touch:

Display Shows:

1. 

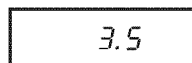

2. The oven will start automatically.

Time counting down.

3. At the end of cooking time, 2 short tones and 1 long tone will sound.

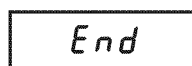

Example: To cook 1 potato

Touch:

Display Shows:

1. 



2. The oven will start automatically.

Time counting down.

3. At the end of cooking time, 2 short tones and 1 long tone will sound.

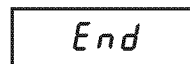

QUICK TOUCH COOKING TABLE

CATEGORY	TOUCH	SERVING SIZE	DIRECTIONS
Beverage	1 time 2 times	1 cup 2 cups	<ul style="list-style-type: none"> • 240ml per cup. • Use mug or microwave-safe cup. • Stir after reheating.
Potato	1 time 2 times 3 times 4 times	1 ea (8 oz.) 2 ea (16 oz.) 3 ea (24 oz.) 4 ea (32 oz.)	<ul style="list-style-type: none"> • 8-10 oz. per potato. • Place in center of the turntable tray on paper towel. • Pierce potato several times with fork. • After cooking, let stand for 5 minutes.
Popcorn	1 time 2 times	3.5 oz. 3.0 oz.	<ul style="list-style-type: none"> • Follow package instructions. • Do not try to pop unpopped kernels. • Heat only 1 package at a time.
Pizza	1 time 2 times 3 times	1 slice 2 slices 3 slices	<ul style="list-style-type: none"> • Follow package instructions to prepare pizza for microwaving. • Place pizza onto a sheet of non-recycled paper towel directly on the turntable.
Food Plate	1 time 2 times	1 serving 2 servings	<ul style="list-style-type: none"> • Arrange the food on a microwave-safe plate. • Cover loosely with plastic wrap.
Frozen Entree	1 time	10 oz.	<ul style="list-style-type: none"> • Remove from outer display package. • If not in microwave-safe container, place on plate cover with plastic wrap and vent.
Fresh Vegetable	1 time 2 times 3 times 4 times	1 cup 2 cups 3 cups 4 cups	<ul style="list-style-type: none"> • Prepare as desired, wash, and leave residual water on the vegetables. • Place the appropriately-sized microwave container. • Cover with plastic wrap and vent.
Baked Goods	1 time 2 times 3 times 4 times	1 ea 2 ea 3 ea 4 ea	<ul style="list-style-type: none"> • Place in center of the turntable tray on paper towel. • After cooking, let stand for 5 minutes. • No cover.
Casserole	1 time 2 times 3 times 4 times	1 cup 2 cups 3 cups 4 cups	<ul style="list-style-type: none"> • Place in appropriately-sized microwave container. • Cover with plastic wrap and vent. • After cooking, allow to stand for 3 minutes.

USING YOUR MICROWAVE OVEN





AUTO DEFROST

Three defrost sequences are preset in the oven. The auto defrost feature provides you with the best defrosting method for frozen foods. The cooking guide will show you which defrost sequence is recommended for the food you are defrosting. For added convenience, the Auto Defrost includes a built-in beep mechanism that reminds you to check, turn over, separate, or rearrange to get best defrost results. Three different defrosting levels are provided.

- 1 MEAT
- 2 POULTRY
- 3 FISH

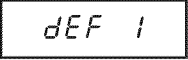
*Available weight is 0.1~6.0 lbs.

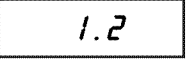

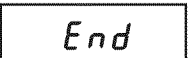
Example: To defrost 1.2 lbs of ground beef.

Touch:	Display Shows:
1.  Auto Defrost	
2.  and  to enter the weight	
3. 	Time counting down.
4. At the end of the defrost time, two short tones and one long tone will sound.	

EXPRESS DEFROST

This feature should be used only when you defrost 1 pound of frozen ground beef.

Example: To defrost 1 lb Ground beef.

Touch:	Display Shows:
1. 	Time of day.
2.  Express Defrost	Time counting down and EXPRESS DEFROST.

NOTE:

When you touch the START pad, the display changes to defrost time count down. The oven will beep during the DEFROST cycle. At this time, open the door and turn, separate, or rearrange the food. Remove any portions that have thawed. Return frozen portions to the oven and touch START to resume the defrost cycle.

OPERATING TIPS

- For best results, remove fish, shellfish, meat, and poultry from its original closed paper or plastic package (wrapper). Otherwise, the wrap will hold steam and juice close to the foods, which can cause the outer surface of the foods to cook.
- For best results, shape your ground meat into the form of a doughnut before freezing. When defrosting, scrape off thawed meat when the beep sounds and continue defrosting.
- Place foods in a shallow container or on a microwave roasting rack to catch drippings.
- Food should still be somewhat icy in the center when removed from the oven.

AUTO DEFROST TABLE

Category	Food to be Defrosted
<i>DEF 1</i> MEAT	Beef Ground beef, Round steak, Cubes for stew, Tenderloin steak, Pot roast, Rib roast, Rump roast, Chuck roast, Hamburger patty Lamb Chops (1 inch thick), Rolled roast Pork Chops (1/2 inch thick), Hot dogs, Spareribs, Country-style ribs. Rolled roast, Sausage Veal Cutlets (1 lb., 1/2 inch thick)
<i>DEF 2</i> POULTRY	Poultry Whole (under 4 lbs.), Cut-up, Breasts (boneless) Cornish Hens Whole Turkey Breast
<i>DEF 3</i> FISH	Fish Fillets, Whole Steaks Shellfish Crab meat, Lobster tails, Shrimp, Scallops

USING YOUR MICROWAVE OVEN

WARNING: Do not use large sheets of aluminum foil because they hinder cooking and may cause arcing. You may use small pieces of foil to shield poultry legs and wings. Keep all aluminum foil at least 1 inch from the walls and door of the oven.

COOKING TIPS

Meat

1. No special techniques are required. Meat should be prepared as with conventional cooking. Season if desired. Always thoroughly defrost meat before cooking.
2. Place the meat on a microwave roasting rack or microwave-proof plate and place on the turntable.
3. Cook according to the Meat Cooking Table (below). Use the longer time for large cuts of meats and the shorter time for small cuts of meats. For thicker chops, use the longer time.
4. Turn the meat once halfway through the cooking time.
5. After cooking time expires, **let stand** for 5-10 minutes inside or outside oven before carving. Wrap in foil for outside standing time. Standing time is very important as it completes the cooking process.
6. Make sure meat, especially pork, is thoroughly cooked before eating.

Meat Cooking Table

Meat	Microwave Power	Cooking Time Per Pound
BEEF		
Standing/Rolled Rib	8	8 to 10 minutes
– Medium	8	9 to 11 minutes
– Well-done	HIGH(100%)	5½ to 8½ minutes
Ground Beef (to brown for casserole)		
Hamburgers, Fresh or defrosted (4 oz. each)		
– 2 patties	HIGH(100%)	2 to 4 minutes
– 4 patties	HIGH(100%)	3 to 5 minutes
PORK		
Loin, Leg	8	12 to 16 minutes
Bacon		
– 4 slices	HIGH(100%)	2 to 3 minutes
– 6 slices	HIGH(100%)	3 to 4 minutes

NOTE: The times listed above are only a guide. Allow for difference in individual tastes and preferences. The times may also vary due to the shape, cut, and composition of the food.

Poultry

1. No special techniques are required. Poultry should be prepared as with conventional cooking. Season if desired.
2. Poultry should be thoroughly defrosted. Remove giblets and any metal clamps.
3. Prick the skin and brush lightly with vegetable oil unless the poultry is self-basting.
4. All poultry should be placed on a microwave roasting rack or a microwave-proof plate and placed on the turntable.
5. Cook according to the instructions in the Poultry Cooking Table below. Turn over halfway through the cooking time. Because of its shape, poultry has a tendency to cook unevenly, especially in very bony parts. Turning food over helps to cook these areas evenly.
6. After cooking time expires, **let stand** for 5-10 minutes inside or outside oven before carving. Wrap in foil for outside standing time. Standing time is very important as it completes the cooking process.
7. Make sure poultry is thoroughly cooked before eating. Whole poultry is completely cooked when the juices run clear from the inside thigh when it is pierced with a sharp knife. Poultry pieces should be pierced with a sharp knife through the thickest part to ensure that the juices are clear and the flesh is firm.

Poultry Cooking Table

Poultry	Microwave Power	Cooking Time Per Pound
CHICKEN		
Whole	8	10 to 14 minutes
Breast (boned)	8	9 to 13 minutes
Portions	8	10 to 16 minutes
TURKEY		
Whole	8	10 to 14 minutes

NOTES:

- The times listed above are only a guide. Allow for difference in individual tastes and preferences. The times may also vary due to the shape, cut, and composition of the food.
- If whole poultry is stuffed, the weight of the stuffed bird should be used when calculating the cooking time.

USING YOUR MICROWAVE OVEN

COOKING TIPS (continued)

Fish

1. Arrange fish in a large shallow non-metallic dish or casserole.
2. Cover with pierced microwave plastic wrap or casserole lid.
3. Place the dish on the turntable.
4. Cook according to the instructions in the Fresh Fish Cooking Table below. Flakes of butter can be added to the fish if desired.
5. Let stand as directed in the Cooking Table before serving.
6. After standing time, check to see that the fish is thoroughly cooked. The fish should be opaque and flake easily.

Fresh Fish Cooking Table

Fish	Microwave Power	Cooking Time Per Pound	Butter	Standing Time
Fish Fillets	HIGH	4 to 7 minutes	Add 15 to 30 ml (1 to 2 tbsp lemon juice)	2 to 3 minutes
Whole Mackerel, Cleaned and Prepared	HIGH	4 to 7 minutes	–	3 to 4 minutes
Whole Trout, Cleaned and Prepared	HIGH	5 to 8 minutes	–	3 to 4 minutes
Salmon Steaks	HIGH	5 to 7 minutes	Add 15 to 30 ml (1 to 2 tbsp lemon juice)	3 to 4 minutes

TROUBLESHOOTING

Questions and Answers

Operation

Question	Answer
Why is the oven light not on during cooking?	There may be several reasons why the oven light is not on. Have you: <ul style="list-style-type: none"> • Set a cooking time? • Touched START?
Why does steam come out of the air exhaust vent?	Steam is normally produced during cooking. The microwave oven has been designed to vent this steam.
Will the microwave oven be damaged if it operates empty?	Yes. Never operate the oven empty or without the glass turntable.
Does microwave energy pass through the viewing screen in the door?	No. The metal screen bounces the energy back to the oven cavity. The holes (or ports) allow only light to pass through. They do not let microwave energy pass through.
Why does a tone sound when a pad on the control panel is touched?	The tone tells you that the setting has been entered.
Can my microwave oven be damaged if food is cooked for too long?	Like any other cooking appliance, it is possible to overcook food to the point that the food creates smoke and even possibly fire, and damage to the inside of the oven. It is always best to be near the oven while you are cooking.
When the oven is plugged into the wall outlet for the first time, and it might not work properly. What is wrong?	The microcomputer controlling your oven may temporarily become scrambled and fail to function as programmed when you plug in for the first time or when power resumes after a power interruption. Unplug the oven from the 120 volt household outlet and then plug it back in to reset the microcomputer.
Why do I see light reflection around the outer case?	This light is from the oven light which is located between the oven cavity and the outer wall of the oven.
What are the various sounds I hear when the microwave oven is operating?	The clicking sound is caused by a mechanical switch turning the microwave oven's magnetron ON and OFF. The heavy hum and clunk is from the change in power the magnetron draws as it is turned ON and OFF by a mechanical switch. The change in blower speed is from the change in line voltage caused by the magnetron being turned ON and OFF.

TROUBLESHOOTING

Questions and Answers (continued)

Food

Question	Answer
What is wrong when baked foods have a hard, dry, brown spot?	A hard, dry, brown spot indicates overcooking. Shorten the cooking or reheating time.
Why do eggs sometimes pop?	When baking, frying, or poaching eggs, the yolk may pop due to steam build-up inside the yolk membrane. To prevent this, simply pierce the yolk with a wooden toothpick before cooking. CAUTION: Never microwave eggs in the shell.
Why are scrambled eggs sometimes a little dry after cooking?	Eggs will dry out when they are overcooked, even if the same recipe is used each time. The cooking time may need to be varied for one of these reasons: <ul style="list-style-type: none"> • Eggs vary in size. • Eggs are at room temperature one time and at refrigerator temperature another time. • Eggs continue cooking during standing time.
Why do baked apples sometimes burst during cooking?	The peel has not been removed from the top half of each apple to allow for expansion of the interior of the apple during cooking. As in conventional cooking methods, the interior of the apple expands during the cooking process.
Why do baked potatoes sometimes burn during cooking?	If the cooking time is too long, fire could result. At the end of the recommended cooking time, potatoes should be slightly firm. CAUTION: Do not overcook.
Why is a standing time recommended after microwave cooking time is over?	Standing time allows foods to continue cooking evenly for a few minutes after the actual microwave oven cooking cycle. The amount of standing time depends upon the density of the foods.
Why is additional time required for cooking food stored in the refrigerator?	As in conventional cooking, the initial temperature of food affects total cooking time. You need more time to cook food taken out of a refrigerator than for food at room temperature.

TROUBLESHOOTING

BEFORE CALLING FOR SERVICE

You can often correct operating problems yourself. If your microwave oven fails to work properly, locate the operating problem in the list below and try the solutions listed for each problem.

If the microwave oven still does not work properly, contact the nearest Sears Parts & Repair Center by calling 1-800-4-MY-HOME®. Sears Parts & Repair Centers are fully equipped to handle your service requirements.

Problem	Possible Causes
Oven does not start	<ul style="list-style-type: none"> • Is the power cord plugged in? • Is the door closed? • Is the cooking time set?
Arcing or Sparking	<ul style="list-style-type: none"> • Are you using approved cookware? • Is the oven operating while empty?
Unevenly Cooked Foods	<ul style="list-style-type: none"> • Are you using approved cookware? • Is the glass turntable in the oven? • Did you turn over or stir the food while it was cooking? • Were the foods completely defrosted? • Was the time/cooking power level correct?
Overcooked Foods	<ul style="list-style-type: none"> • Was the time/cooking power level correct?
Undercooked Foods	<ul style="list-style-type: none"> • Are you using approved cookware? • Were the foods completely defrosted? • Was the time/cooking power level correct?
Improper Defrosting	<ul style="list-style-type: none"> • Are you using approved cookware? • Was the time/cooking power level correct? • Did you turn over or stir the food during the defrosting cycle?

ENGLISH

FEDERAL COMMUNICATIONS COMMISSION RADIO FREQUENCY INTERFERENCE STATEMENT (U.S.A. ONLY)

WARNING:

This equipment generates and uses ISM frequency energy and if not installed and used properly, that is in strict accordance with the manufacturer's instructions, may cause interference to radio and television reception. It has been type tested and found to comply with limits for ISM Equipment pursuant to part 18 of FCC Rules, which are designed to provide reasonable protection against such interference in a residential installation.

However, there is no guarantee that interference will not occur in a particular installation. If this equipment does cause interference to radio or television reception, which can be determined by turning the equipment off and on, the user is encouraged to try to correct the interference by one or more of the following:

- Reorient the receiving antenna of the radio or television.
- Relocate the Microwave Oven with respect to the receiver.
- Move the microwave oven away from the receiver.
- Plug the microwave oven into a different outlet so that the microwave oven and the receiver are on different branch circuits.

The manufacturer is not responsible for any radio or TV interference caused by **unauthorized modification** to this microwave oven. It is the responsibility of the user to correct such interference.

Get it fixed, at your home or ours!

Your Home

For expert troubleshooting and home solutions advice:

manage my home

www.managemyhome.com

For repair – **in your home** – of **all** major brand appliances, lawn and garden equipment, or heating and cooling systems, **no matter who made it, no matter who sold it!**

For the replacement parts, accessories and owner's manuals that you need to do-it-yourself.

For Sears professional installation of home appliances and items like garage door openers and water heaters.

1-800-4-MY-HOME® (1-800-469-4663)

Call anytime, day or night (U.S.A. and Canada)

www.sears.com www.sears.ca

Our Home

For repair of carry-in items like vacuums, lawn equipment, and electronics, call anytime for the location of your nearest

Sears Parts & Repair Service Center

1-800-488-1222 (U.S.A.)

www.sears.com

1-800-469-4663 (Canada)

www.sears.ca

To purchase a protection agreement on a product serviced by Sears:

1-800-827-6655 (U.S.A.)

1-800-361-6665 (Canada)

Para pedir servicio de reparación a domicilio, y para ordenar piezas:

1-888-SU-HOGAR®

(1-888-784-6427)

Au Canada pour service en français:

1-800-LE-FOYER^{MC}

(1-800-533-6937)

www.sears.ca

Sears