

# use & care guide

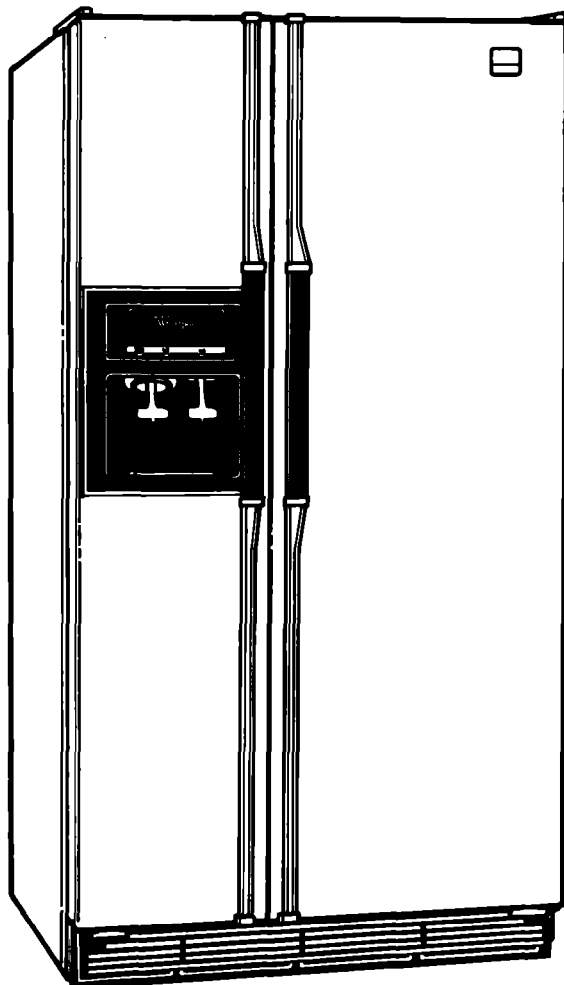

## NO-FROST REFRIGERATOR- FREEZER

Model ED22DW

T

Freezers, Ice Makers, Dishwashers, Built-In Ovens and Surface Units, Ranges, Microwave Ovens, Trash Compactors, Room Air Conditioners, Dehumidifiers, Automatic Washers, Clothes Dryers, Freezers, Re

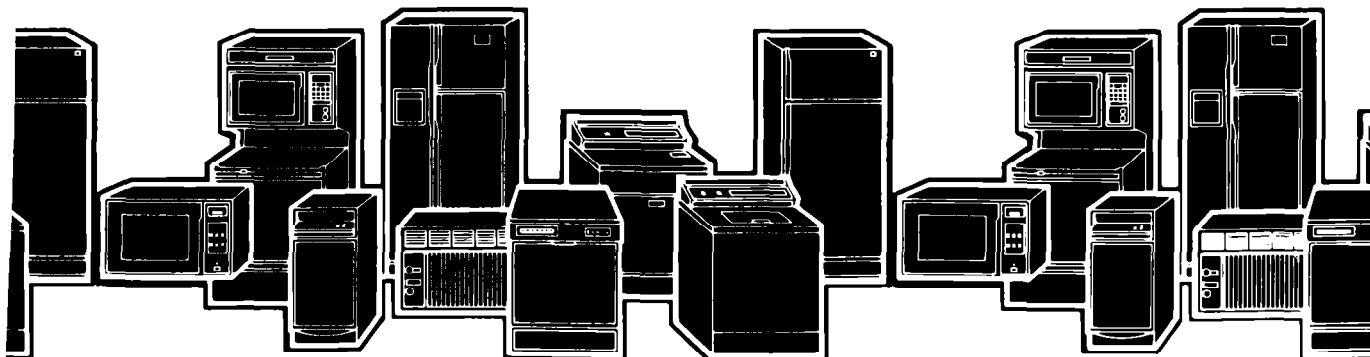

# Please read this Use and Care Guide before you do anything else...

This booklet tells you how to start your refrigerator, clean it, move shelves and adjust controls. It even tells you what new sounds to expect from your refrigerator.

Treat your new refrigerator with care. Use it only to do what home refrigerators are designed to do.

## Parts and features

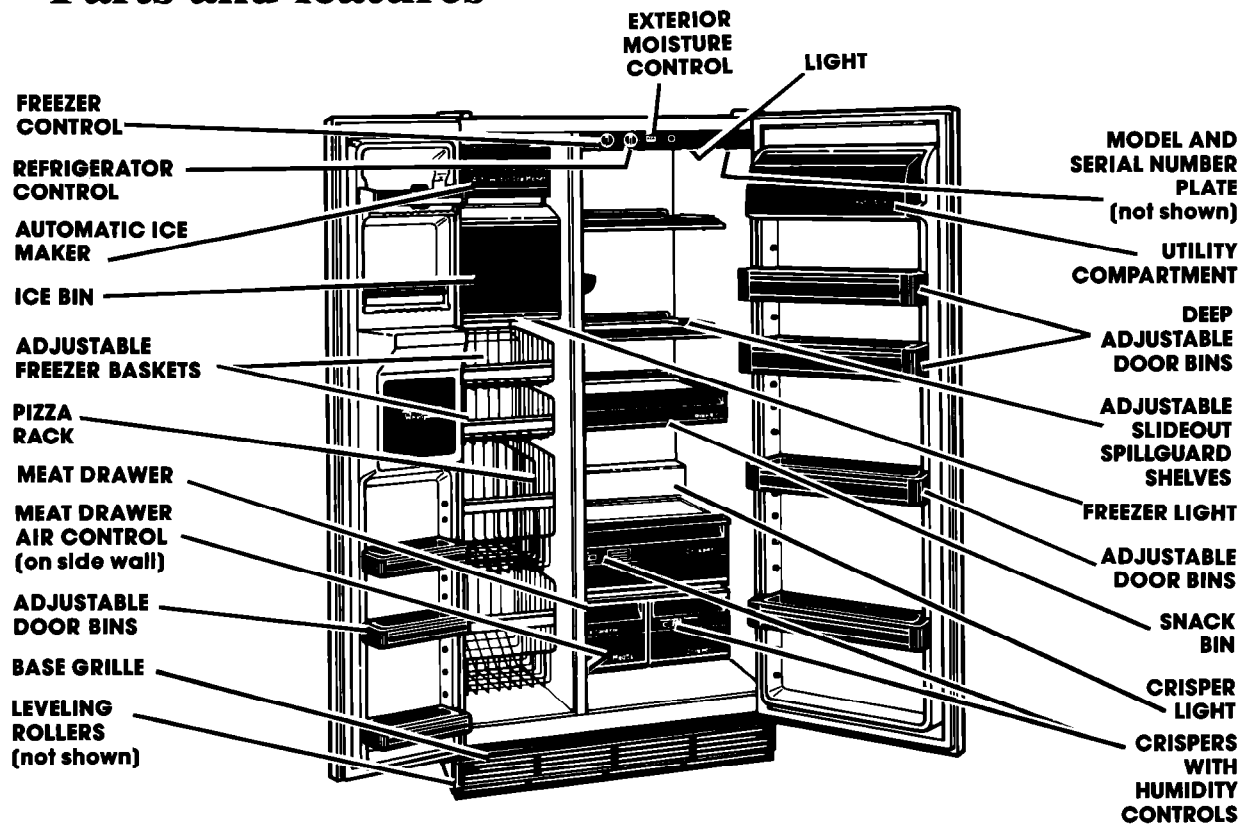

**Thank you for buying a Whirlpool appliance. Please complete and mail the Owner Registration Card provided with this product.** Then complete the form below. Have this information ready if you need service or call with a question.

- Copy Model and Serial Numbers from plate (see diagram above) and purchase date from sales slip.
- Keep this book and sales slip together in a handy place.

\_\_\_\_\_

Model Number

\_\_\_\_\_

Serial Number

\_\_\_\_\_

Purchase Date

\_\_\_\_\_

Service Company Phone Number

## Contents

	Page		Page
<b>IMPORTANT SAFETY INSTRUCTIONS</b> . . . . .	3	Adjusting the Wine Rack . . . . .	7
<b>BEFORE USING YOUR REFRIGERATOR</b> . . . . .	4	Removing the Freezer Baskets . . . . .	7
Remove Sales Label . . . . .	4	Adjusting the Door Bins . . . . .	7
Clean It . . . . .	4	Changing the Light Bulbs . . . . .	8
Plug It In . . . . .	4	Removing the Base Grille . . . . .	8
Install Properly . . . . .	4	Cold Water and Ice Dispenser . . . . .	9
Level Refrigerator-Freezer . . . . .	4	Sounds You May Hear . . . . .	11
<b>USING YOUR REFRIGERATOR</b> . . . . .	5	Energy Saving Tips . . . . .	11
Setting the Controls . . . . .	5	<b>CLEANING YOUR REFRIGERATOR</b> . . . . .	11
Changing the Control Settings . . . . .	5	Cleaning Chart . . . . .	12
Exterior Moisture Control . . . . .	5	<b>FOOD STORAGE GUIDE</b> . . . . .	13
Adjusting the Crisper Humidity Control . . . . .	6	Storing Fresh Food . . . . .	13
Adjusting Meat Drawer Temperature . . . . .	6	Storing Frozen Food . . . . .	14
Adjusting the Refrigerator Shelves . . . . .	6	<b>VACATION AND MOVING CARE</b> . . . . .	17
Removing the Crispers, Meat Drawer and Covers . . . . .	6	<b>IF YOU NEED SERVICE OR ASSISTANCE</b> . . . . .	18
Removing the Snack Bin . . . . .	7	<b>WHIRLPOOL REFRIGERATOR WARRANTY</b> . . . . .	20

©1989 Whirlpool Corporation

# IMPORTANT SAFETY INSTRUCTIONS

## **⚠ WARNING**

To reduce the risk of fire, electrical shock, or injury when using your refrigerator, follow basic precautions including the following:

- Read all instructions before using the refrigerator.
- Child entrapment and suffocation are not problems of the past. Junked or abandoned refrigerators are still dangerous... even if they will "just sit in the garage a few days."  
If you are getting rid of your old refrigerator, do it safely. Please read the enclosed safety booklet from the Association of Home Appliance Manufacturers. Help prevent accidents.
- Never allow children to operate, play with, or crawl inside the refrigerator.
- Never clean refrigerator parts with flammable fluids. The fumes can create a fire hazard or explosion.

• FOR YOUR SAFETY •

**DO NOT STORE OR USE GASOLINE OR OTHER FLAMMABLE VAPORS AND LIQUIDS IN THE VICINITY OF THIS OR ANY OTHER APPLIANCE. THE FUMES CAN CREATE A FIRE HAZARD OR EXPLOSION.**

**It is your responsibility to be sure your refrigerator:**

- is installed and leveled on a floor that will hold the weight, and in an area suitable for its size and use.
- is connected only to the right kind of outlet, with the right electrical supply and grounding. (Refer to the Electrical Requirements and Grounding Instructions Sheet.)
- is used only to do what home refrigerators are designed to do.
- is not near an oven, radiator or other heat source.
- is properly maintained.
- is out of the weather.
- is used in an area where the room temperature will not fall below 55°F (13°C).
- is not used by anyone unable to operate it properly.
- is not loaded with food before it has time to get properly cold.

– SAVE THESE INSTRUCTIONS –

# Before using your refrigerator

## 1. Remove sales labels...

Remove the Consumer Buy Guide Label, tape and any **inside** labels before using the refrigerator. **To remove any remaining glue:**

1. Rub briskly with thumb to make a ball then remove.

**OR**

2. Soak area with liquid hand dishwashing detergent before removing glue as described in step 1.

**DO NOT USE sharp instruments, rubbing alcohol, flammable fluids or abrasive cleaners. These can damage the material. See "Important Safety Instructions" on page 3.**

**NOTE: DO NOT REMOVE ANY PERMANENT INSTRUCTION LABELS INSIDE YOUR REFRIGERATOR. Do not remove the Tech Sheet fastened under the refrigerator at the front.**

## 2. Clean it...

Clean your refrigerator before using it. See cleaning instructions on page 11.

## 3. Plug it in...

3-PRONG GROUNDING  
TYPE WALL RECEPTACLE

REFRIGERATOR  
POWER CORD

3-PRONG  
GROUNDING PLUG

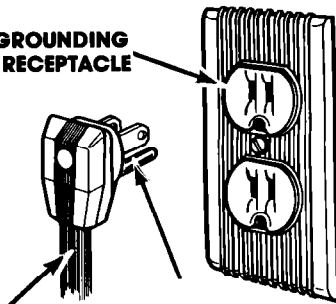

### RECOMMENDED GROUNDING METHOD

A 115 Volt, 60 Hz., AC only 15 or 20 ampere fused and properly grounded electrical supply is required. It is recommended that a separate circuit serving only this appliance be provided.

**Do not use an extension cord. Use a receptacle which cannot be turned off with a switch or pull chain.** See Electrical Requirements and Grounding Instruction Sheet in your Literature Package.

## 4. Install properly...

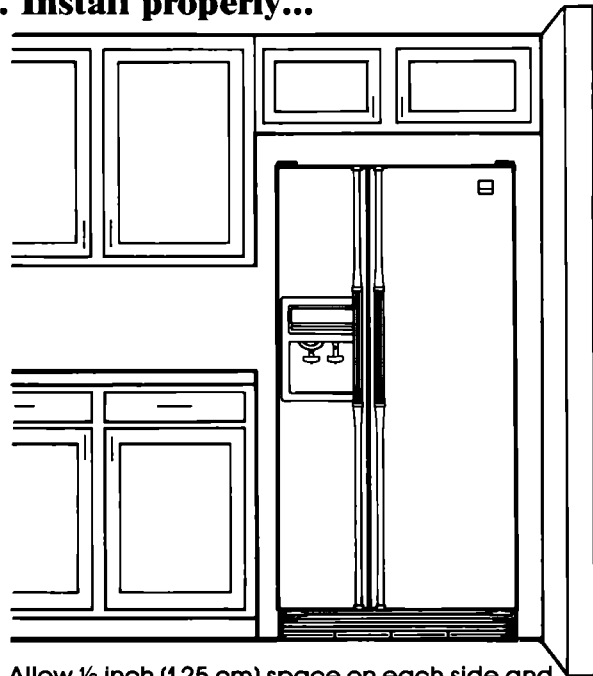

1. Allow  $\frac{1}{2}$  inch (1.25 cm) space on each side and at the top of the refrigerator for ease of installation.
2. If the refrigerator is to be against a wall, you might want to leave extra space on the hinge side closest to the wall so the door can be opened wider.
3. The refrigerator back can be flush against the wall.
4. Make sure ice maker water supply has been connected. Refer to Installation Instructions.

## 5. Level refrigerator-freezer...

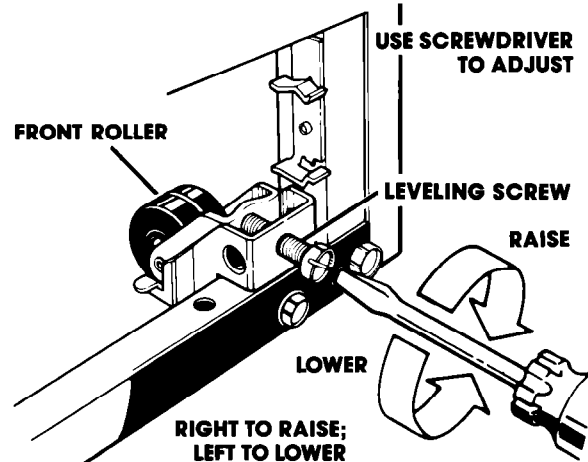

1. Remove base grille. (See page 8.)
2. To raise front, turn screw in direction shown.
3. To lower front, turn screw in direction shown.
4. Check with level.
5. Replace base grille. (See page 8.)

# Using your refrigerator

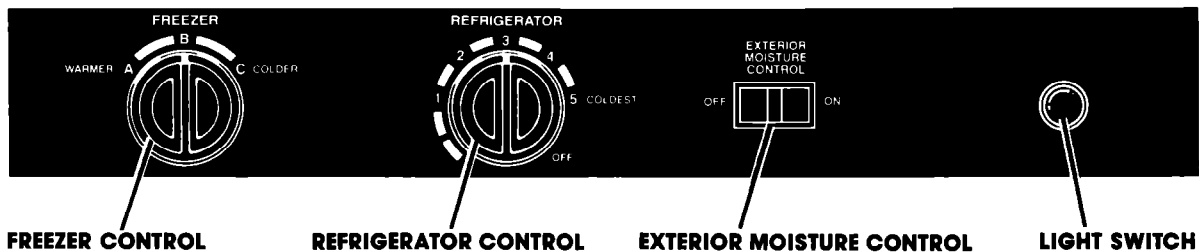

## Setting the controls...

Controls for the refrigerator and freezer are in the refrigerator. When the refrigerator is plugged in for the first time...

1. Set the REFRIGERATOR CONTROL to 3.



2. Set the FREEZER CONTROL to B.



**Give the refrigerator time to cool down completely before adding food.** (This may take several hours.)

**These settings should be about right for normal household refrigerator usage.**

The controls will be set about right when milk or juice is as cold as you like and when ice cream is firm.

## Changing the control settings...

If you need to adjust temperatures in refrigerator or freezer, use the settings listed in the chart below.

- Adjust the Refrigerator Control first.
- Wait at least 24 hours between adjustments.
- Then adjust the Freezer Control if needed.



### QUESTIONS?

...call your COOL-LINE® service assistance telephone number (page 18).

CONDITION:	REASON:	RECOMMENDED CONTROL SETTINGS:
If Refrigerator Section is TOO WARM	Door opened often Large amount of food added Room temperature too warm	Refrigerator 4 Freezer A
If Freezer Section is TOO WARM	Door opened often Large amount of food added Very cold room temperature (can't cycle often enough)	Refrigerator 3 Freezer C
If Refrigerator Section is TOO COLD	Controls not set correctly for your conditions	Refrigerator 2 Freezer B
If ICE isn't MADE FAST ENOUGH	Heavy ice usage Very cold room temperature (can't cycle often enough)	Refrigerator 3 Freezer C
If BOTH SECTIONS are TOO WARM	Door opened often Large amount of food added Very warm or very cold room temperatures	Refrigerator 4 Freezer B

## Exterior Moisture Control

The **Exterior Moisture Control** on the Control Console operates electric heaters around the door openings. These heaters help keep moisture from forming on the outside of the refrigerator.

1. Use the "OFF" setting when humidity is low.
2. Use the "ON" setting if moisture forms on the outside of the refrigerator.

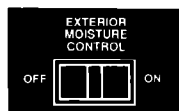

## Adjusting the crisper humidity control...

You can control the amount of humidity in the moisture-sealed crisper.

1. The control can be adjusted to any setting between LOW and HIGH.
2. LOW (open) lets moist air out of crisper for best storage of fruits and vegetables with skins.
3. HIGH (closed) keeps moist air in the crisper for best storage of fresh leafy vegetables.

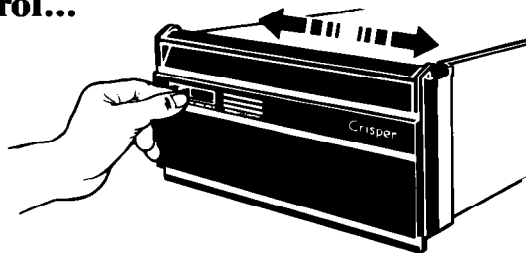

## Adjusting meat drawer temperature...

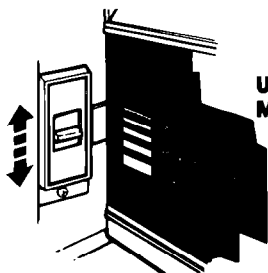

**USE CONTROL TO ADJUST MEAT DRAWER TEMPERATURE**

Cold air flows against the meat drawer through an opening between the freezer and the refrigerator. This helps keep the meat drawer colder than the rest of the refrigerator.

Slide the control to let more or less cold air through.

## Adjusting the refrigerator shelves...

SPILLAGUARD shelves can be adjusted to match the way you use your refrigerator. Glass shelves are strong enough to hold bottles, milk and other heavy food items.



**GLASS SHELVES ARE HEAVY. BE CAREFUL.**

### To remove glass shelves:

1. Remove items from shelf.
2. Slide shelf out with an even, constant pull to the stop.
3. Lift front and slide the rest of the way out.

### To move shelf guides to new position:

1. Lift front of guide. Pull guide forward off rear support. Repeat for other guide.
2. To replace guide, push guide onto rear support. Push front of guide down onto support.

### To replace glass shelves:

1. Guide rear of shelf into shelf guide.
2. Slide shelf into place.

## Removing the crispers, meat drawer and covers...

### To remove the crispers and meat drawer:

1. Slide crispers and meat drawer straight out to the stop. Lift the front, then slide the rest of the way out.
2. Replace in reverse order.

### To remove the covers:

1. Lift front of cover off supports.
2. Lift out cover by pulling up and out.

### To replace the covers:

- Fit back of cover in notch supports on walls of refrigerator, then lower into place.

**NOTE: Glass cover will fit only above full width crisper.**

**PULL OUT TO THE STOP, LIFT THE FRONT AND PULL AGAIN.**

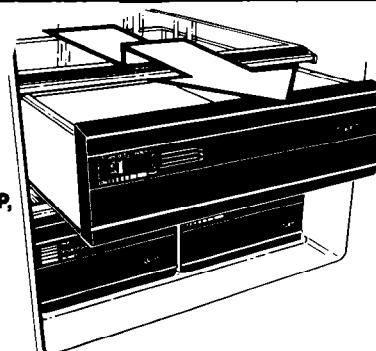

**LIFT THE COVER FRONT, THEN THE BACK.**

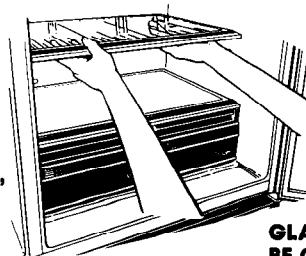

**GLASS IS HEAVY, BE CAREFUL.**

## Removing the snack bin...

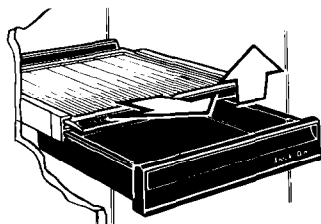

**PULL OUT TO THE STOP, LIFT THE FRONT AND PULL AGAIN.**

### To remove the snack bin:

1. Slide snack bin with an even, constant motion straight out to the stop.
2. Lift the front.
3. Slide bin the rest of the way out.
4. Replace in reverse order.

## Adjusting the wine rack...

### To move the wine rack:

1. Lift front of wine rack.
2. Pull rack off rear support.
3. Replace in reverse order.

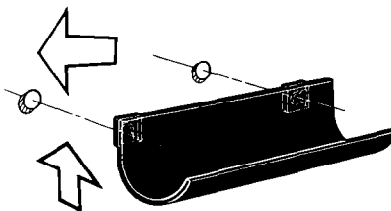

## Removing the freezer baskets...

### To remove a basket:

1. Slide out to the stop.
2. Lift the front to clear the stop.
3. Slide out the rest of the way.

### To replace a basket:

1. Place basket on the slides.
2. Make sure the wire stops clear the front of the slides.
3. Slide basket in.

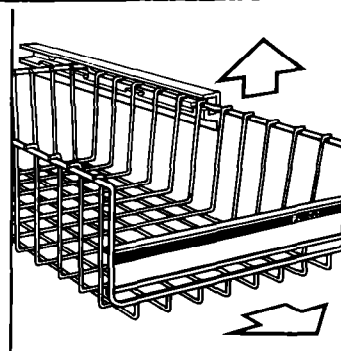

**PULL OUT TO THE STOP, LIFT THE FRONT AND PULL AGAIN.**

## Adjusting the door bins...

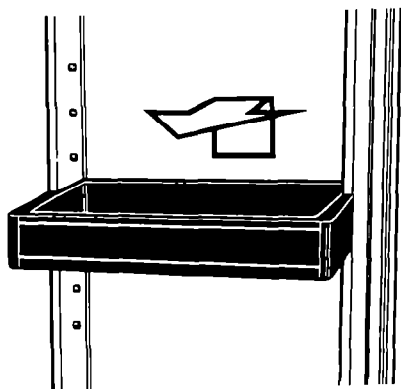

### To remove a door bin:

1. Lift bin straight up.
2. Pull bin straight out.

### To replace a door bin:

1. Slide bin straight in above guides.
2. Push bin straight down.

**NOTE: Large bins are designed to fit in top portion of refrigerator door only.**

## Changing the light bulbs...

### ⚠ WARNING

#### Electrical Shock Hazard

Before removing a light bulb, either unplug the refrigerator or disconnect the electricity leading to the refrigerator at the main power supply. Shock and injury can occur if electricity remains connected.

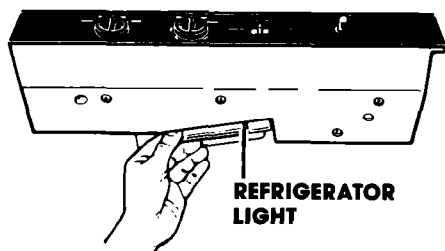

#### To change refrigerator light:

1. Disconnect refrigerator from power supply.
2. Reach behind the control console to find bulb.
3. Remove bulb.
4. Replace with a 40-watt appliance bulb.
5. Reconnect power supply.

#### To change freezer light:

1. Disconnect refrigerator from power supply.
2. Push in sides of light shield until it snaps free.
3. Replace bulb with a 40-watt appliance bulb.
4. Replace the light shield.
5. Reconnect power supply.

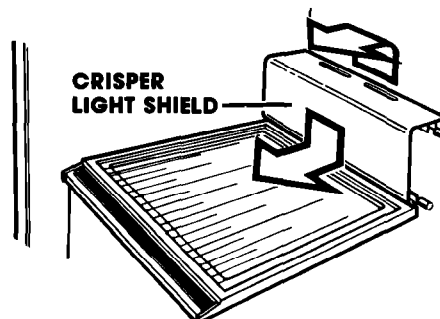

#### To change crisper light:

1. Disconnect refrigerator from power supply.
2. Pull top of light shield forward until it snaps free.
3. Lower light shield to clear bottom supports.
4. Pull light shield straight out to remove.
5. Replace bulb with a 40-watt appliance bulb.
6. Replace light shield in reverse order.
7. Reconnect power supply.

#### To change dispenser light:

1. Disconnect refrigerator from power supply.
2. Reach the bulb through the dispenser area.
3. Replace with a heavy duty 10-watt bulb.
4. Reconnect power supply.

## Removing the base grille...

#### To remove the grille:

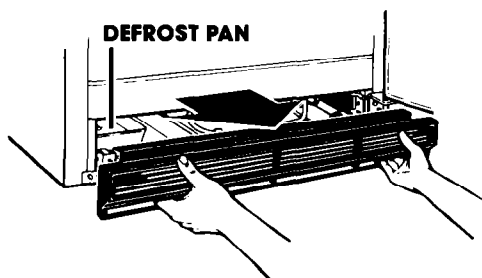

1. Open the doors.
2. Pull grille outward as shown.
3. **Do not remove Tech sheet** fastened behind grille.

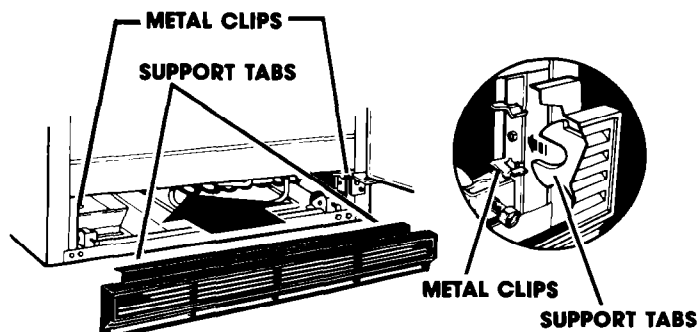

#### To replace the grille:

1. Line up grille support tabs with metal clips.
2. Push firmly to snap into place.
3. Close the doors.

See cleaning instructions for defrost pan and condenser coils on page 12.



## Cold water and ice dispenser...

### FOR ICE:

Press a **sturdy** glass against the ice dispenser bar. (Pressure and tumbling ice can break a fragile glass.) Remove the glass to stop dispensing.

The first few batches of ice from the ice maker may have a bad taste from new plumbing and parts. Throw them away.

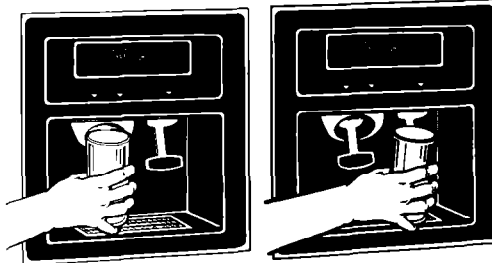

**Press against Ice Dispenser Bar**

The small tray beneath the dispenser is designed to evaporate **small** spills. There is no drain in this tray. **Do not pour water into it.**

**Ice is dispensed** from the ice maker storage bin in the freezer. When the dispenser bar is pressed, a trapdoor opens in a chute between the dispenser and the ice bin. Ice is moved from the bin and falls through the chute. When the dispenser bar is released, a faint buzzing sound may be heard for a few seconds.

**Chilled water** comes from a tank behind the meat drawer. It holds about 50 ounces (1.5L).

When the refrigerator is first hooked up press the water dispenser with a glass or jar until you have drawn and discarded 2 or 3 quarts (1.9 to 2.8L).

The water you draw and discard will rinse the tank and pipes.

Allow several hours to chill the first tankful.

**NOTE: Large amounts of ice should be taken from the bin, not through the dispenser.**

## Common ice maker problems

PROBLEM	CAUSE	SOLUTION
<b>Dispenser won't work.</b>	Freezer door open.	<ul style="list-style-type: none"> <li>• Close the freezer door.</li> </ul>
<b>Ice dispenser won't work.</b>	Ice bin not properly installed. Wrong ice in bin.  Dispenser not used for extended periods, causing ice cubes to melt together.	<ul style="list-style-type: none"> <li>• Make sure bin is pushed in all the way.</li> <li>• <b>Use only ice crescents from ice maker.</b> Shake the bin occasionally to keep cubes separated, and to obtain increased storage capacity.</li> <li>• Dump old ice and make new supply.</li> </ul>
<b>Ice dispenser stops working.</b>	Ice dispenser bar held in too long.	<ul style="list-style-type: none"> <li>• Wait about 3 minutes for the dispenser motor to reset.</li> <li>• Large amounts of ice should be taken from the bin, <b>not through the dispenser.</b></li> </ul>
<b>Off-taste or odor in ice.</b>	Ice attracts airborne odors; old ice. Water quality.  Foods not properly wrapped. Ice bin and freezer may need cleaning. Plumbing to ice maker.  New ice maker.	<ul style="list-style-type: none"> <li>• Dump old ice and make new supply; store excess ice in covered container.</li> <li>• Water containing minerals (such as sulfur) may require a filter to remove.</li> <li>• Wrap properly. See pages 14 and 15.</li> <li>• Clean freezer and ice bin. See "Cleaning chart" on page 12.</li> <li>• Follow Installation Instructions for proper ice maker water supply hook-up.</li> <li>• The first few loads of ice from a new ice maker may have an off-taste. Dump ice and make new supply.</li> </ul>

### TIPS

- The dispensers will work only with the freezer door closed.
- When you need more ice than a glass or two, scoop it from the bin or remove the bin. The dispenser motor may stop if the dispenser bar is held in too long. It will be ready to run again in about 3 minutes.
- Good water quality is important for good ice quality. It is not recommended that the ice maker be connected to a softened water supply. Water softener chemicals such as salt from a malfunctioning softener can damage the ice maker mold and lead to poor quality ice. If a softened water supply cannot be avoided, then it is important that the water softener be well maintained and operating properly.

**Plan to remove and empty the storage bin:**

- If the ice dispenser has not, or will not be used for a week or more;
- If a power failure causes ice in the bin to melt and freeze together;
- If the ice dispenser is not used regularly.

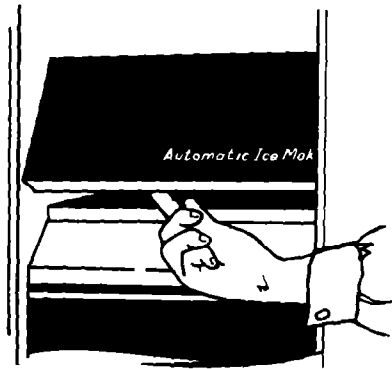

1. Pull the covering panel out from the bottom and slide it to the rear.

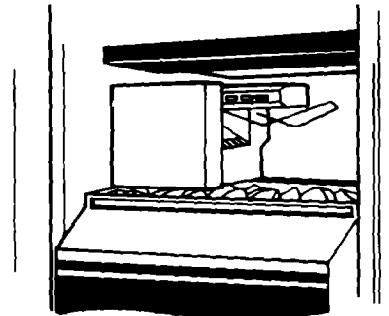

2. Lift the signal arm so it clicks into the OFF position. Ice can still be dispensed, but no more will be made.

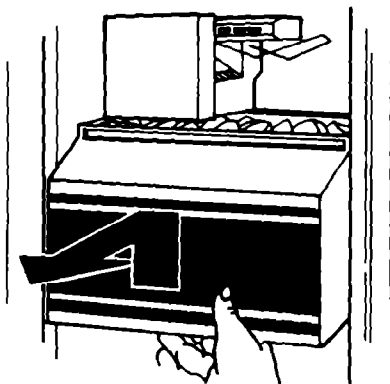

3. Lift the front of the storage bin. Pull it out.
4. Empty the bin. Use hot or warm water to melt the ice if necessary. **Never use anything sharp** to break up ice in the bin. This can damage the bin and dispenser mechanism.
5. Wash with mild detergent. Rinse well. Do not use harsh or abrasive cleansers or solvents.
6. When replacing the bin, make sure it is pushed in all the way. Push the signal arm down to the ON position to restart ice production.

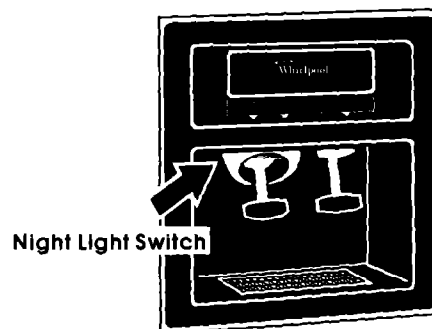

**The night light** uses a heavy-duty 10-watt bulb. When it burns out, purchase another from your dealer.

## Sounds you may hear...



Your new refrigerator may make sounds that your old one didn't. Because the sounds are new to you, you might be concerned about them. Don't be. Most of the new sounds are normal. Hard surfaces like the floor, walls and cabinets can make the sounds seem louder.

The following chart describes the kinds of sounds that might be new to you, and what may be making them.

Possible Sounds:	Probable Causes:
• <b>Slight Hum, Soft Hiss:</b>	You may hear the refrigerator's fan motor and moving air.
• <b>Clicking or Snapping Sounds:</b>	The thermostat makes a definite click when the refrigerator stops running. It also makes a sound when the refrigerator starts. The defrost timer will click when the defrost cycle starts and stops.
• <b>Water Sounds:</b>	When the refrigerator stops running, you may hear gurgling in the tubing for a few minutes after it stops. You may also hear defrost water running into the defrost water pan.
• <b>Ice Maker Sounds:</b> – trickling water – thud (clatter of ice)	When the ice maker is running you may hear buzzing (from the water valve), trickling water and the clatter of ice dumped into the bin.
• <b>Running Sounds:</b>	Your refrigerator has a high-efficiency compressor and motor. It will run longer than older designs. It may even seem to run most of the time.

## Energy saving tips...

You can help your refrigerator use less electricity.

- Check door gaskets for a tight seal. Level the cabinet to be sure of a good seal.
- Clean the condenser coils regularly.
- Open the door as few times as possible. Think about what you need before you open the door. Get everything out at one time. Keep foods organized so you won't have to search for what you want. Close door as soon as food is removed.
- Go ahead and fill up the refrigerator, but don't over crowd it so air movement is blocked.

- It is a waste of electricity to set the refrigerator and freezer to temperatures colder than they need to be. If ice cream is firm in the freezer and drinks are as cold as your family likes them, that's cold enough.
- Keep the Exterior Moisture Control on the "OFF" setting unless moisture forms on refrigerator exterior.
- Make sure your refrigerator is not next to a heat source such as a range, water heater, furnace, radiator or in direct sunlight.

## Cleaning your refrigerator

Both the refrigerator and freezer sections defrost automatically. But both should be cleaned about once a month to help prevent odors from building up. Of course, spills should be wiped up right away.

To clean your refrigerator turn the Refrigerator Control to OFF, unplug it, take out all removable parts and clean it according to the following directions.



continued on next page

## Cleaning chart

PART	WHAT TO USE	HOW TO CLEAN
<b>Removable parts</b> (shelves, crisper, meat drawer, etc.)	Sponge or cloth; mild detergent and warm water.	<ul style="list-style-type: none"> <li>• Wash removable parts by hand with warm water and a mild detergent.</li> <li>• Rinse and dry.</li> </ul>
<b>Outside</b>	Sponge, cloth or paper towel; mild detergent; appliance wax (or good auto paste wax).	<ul style="list-style-type: none"> <li>• Wash with warm water and a mild detergent. <b>Do not use abrasive or harsh cleansers.</b></li> <li>• Rinse and dry.</li> <li>• Wax painted metal surfaces at least twice a year with appliance wax or a good auto paste wax. Apply wax with a clean, soft cloth. <b>Do not use wax on plastic parts.</b></li> </ul>
<b>Waxing painted metal surfaces provides rust protection.</b>		
<b>Inside walls</b> (Freezer should be allowed to warm up so cloth won't stick.)	Sponge, soft cloth or paper towel, baking soda, warm water, mild detergent.	<ul style="list-style-type: none"> <li>• Wash with warm water and               <ul style="list-style-type: none"> <li>– mild detergent or</li> <li>– baking soda (2 tablespoons [26 g] to 1 quart [.95 L.] warm water).</li> </ul> </li> <li>• Rinse and dry.</li> </ul>
<b>Door liners and gaskets</b>	Sponge, soft cloth or paper towel; mild detergent, warm water.	<ul style="list-style-type: none"> <li>• Wash with mild detergent and warm water.</li> <li>• Rinse and dry.</li> </ul>
<b>DO NOT USE cleaning waxes, concentrated detergents, bleaches or cleansers containing petroleum on plastic parts.</b>		
<b>Dark plastics</b> (covers and panels)	Mild detergent and warm water; soft, clean sponge or soft, clean cloth.	<ul style="list-style-type: none"> <li>• Wash with a soft cloth or sponge.</li> <li>• Rinse and dry.</li> </ul>
<b>DO NOT USE paper towels, window sprays, scouring cleansers, or flammable fluids. These can scratch or damage the material. See "Important Safety Instructions" on page 3.</b>		
<b>Defrost pan</b>	Sponge or cloth; mild detergent and warm water.	<ul style="list-style-type: none"> <li>• Remove base grille. (See page 8.)</li> <li>• To remove defrost pan, lift pan over wire brace (remove tape; if any).</li> <li>• Wash defrost pan with warm water and mild detergent.</li> <li>• Rinse and dry.</li> <li>• Replace with notched corner to the rear. Push it all the way in.</li> <li>• Make sure defrost drain tube is pointing into pan.</li> <li>• Replace base grille.</li> </ul>
<b>Condenser coils</b>	Vacuum cleaner; using the extended narrow attachment.	<ul style="list-style-type: none"> <li>• Remove base grille.</li> <li>• Clean dust and lint from condenser at least every other month.</li> <li>• Replace base grille.</li> </ul>
<b>Floor under refrigerator</b>	Floor cleaners.	<ul style="list-style-type: none"> <li>• Roll refrigerator out only as far as water supply line allows.</li> <li>• Clean the floor.</li> <li>• Roll refrigerator back.</li> <li>• Check to see if the refrigerator is level.</li> </ul>

## Food storage guide

There is a right way to package and store refrigerated or frozen food. To keep food fresher, longer, take the time to study these recommended steps.

### STORING FRESH FOOD



**Leafy Vegetables...**Remove store wrapping and trim or tear off bruised and discolored areas. Wash in cold water and drain. Place in plastic bag or plastic container and store in crisper. Cold, moist air helps keep leafy vegetables fresh and crisp.

**Vegetables with Skins** (carrots, peppers)...Store in crisper, plastic bags or plastic container.

**Fruit...**Wash, let dry and store in refrigerator in plastic bags or crisper. Do not wash or hull berries until they are ready to use. Sort and keep berries in their store container in a crisper, or store in a loosely closed paper bag on a refrigerator shelf.



**Meat ...**Meat is perishable and expensive...you won't want to waste an ounce of it through careless handling. The following list and chart give you packaging hints and time limits. Store meat in the meat drawer.

**Fresh, Prepackaged Meat.** Store fresh meat in the store wrapping. Vacuum packaged meat can be frozen for as long as one month if the seal is not broken. If you want to keep it frozen longer, you should wrap it with special freezer wrapping material.

**Fresh Meat, Not Prepackaged.** Remove the market wrapping paper and re-wrap in aluminum foil for storing if unfrozen.

**Cooked Meat.** Wrap or cover cooked meat with plastic wrap or aluminum foil. Store immediately.

**Cured or Smoked Meat and Cold Cuts.** Ham, bacon, sausage, cold cuts, etc., keep best in original wrappings. Once opened, tightly re-wrap in plastic wrap or aluminum foil.

**Canned Ham.** Store in refrigerator unless the label says it's okay to store on the shelf. Do not freeze.

**Fresh Poultry...**Wrap in plastic wrap. The plastic on poultry, as purchased, may be used for storage.

#### STORAGE CHART FOR FRESH AND CURED MEAT\*

Type	Approximate Time (days)
Variety Meats .....	1 to 2
Chicken .....	1 to 2
Ground Beef .....	1 to 2
Steaks and Roasts .....	3 to 5
Cured Meats .....	7 to 10
Bacon .....	5 to 7
Cold Cuts .....	3 to 5

\*If meat is to be stored longer than the times given, follow the directions for freezing.

**NOTE: Fresh fish and shellfish should be used the same day as purchased.**

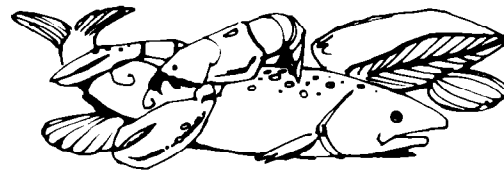

**Eggs...**Store without washing in the original carton on interior shelf.

**Milk...**Wipe milk cartons. For best storage, place milk on interior shelf.

**Beverages...**Wipe bottles and cans. Store in a door bin or inside the refrigerator.

**Butter...**Keep opened butter in covered dish or in the Utility Compartment. When storing an extra supply, wrap in freezer packaging and freeze.

**Cheese...**Store in the original wrapping until you are ready to use it. Once opened, re-wrap tightly in plastic wrap or aluminum foil.

**Condiments...**Store small jars and bottles (catsup, mustard, jelly, olives) in the door bins where they are in easy reach.

**Leftovers...**Cover leftovers with plastic wrap or aluminum foil to keep food from drying out and transferring food odors. Plastic containers with tight lids are fine, too.

## STORING FROZEN FOOD

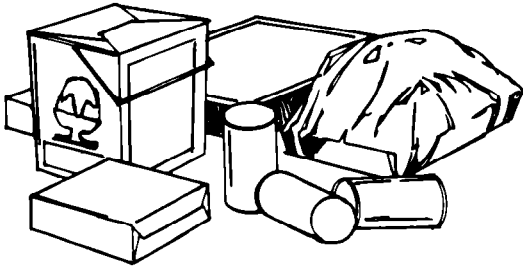

The freezer section is designed for storage of commercially frozen food and for freezing food at home.

**Packaging** – The secret of successful freezing is in the packaging. The wrap you use must be air, moisture and vapor proof. The way you close and seal the package must not allow air, moisture or vapor in or out. Packaging done in any other way could cause food odor and taste transfer throughout the refrigerator and drying of frozen food.

Rigid polyethylene (plastic) containers with tight fitting lids, straight-sided canning/freezing jars, heavy-duty aluminum foil, plastic-coated paper and nonpermeable plastic wraps (made from a saran film) are recommended. **NOTE: Heat-sealed boiling bags are easy to use and can be used by themselves or as carton liners.**

**Sealing** – When sealing food in bags, **squeeze out the air** (liquids need headspace to allow for expansion). Twist the top and turn it back. Fasten tie securely around the doubled-over tail. Put the label inside transparent bags; use self-adhesive label on outside of opaque ones.

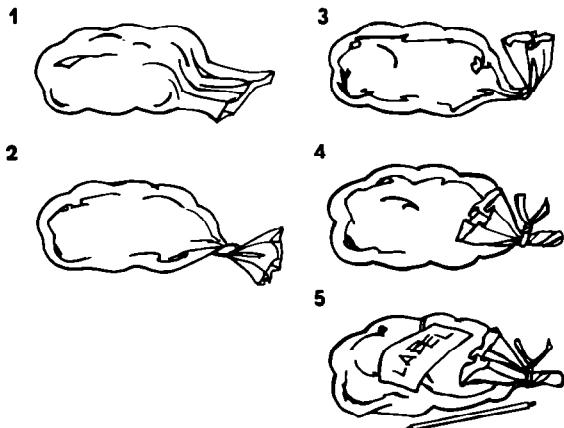

Air-tight wrapping calls for nonpermeable wrap. See recommended wraps under "Packaging." Cut the sheet about one-third longer than the distance around the food. Bring the ends together and fold in (toward the food) at least twice to seal out air. Crease ends close to food, press air from package. Fold tips over twice. Finish package and tape closed. **NOTE: Pad sharp edges of boned meat with extra wrap to protect the wrap from punctures.**

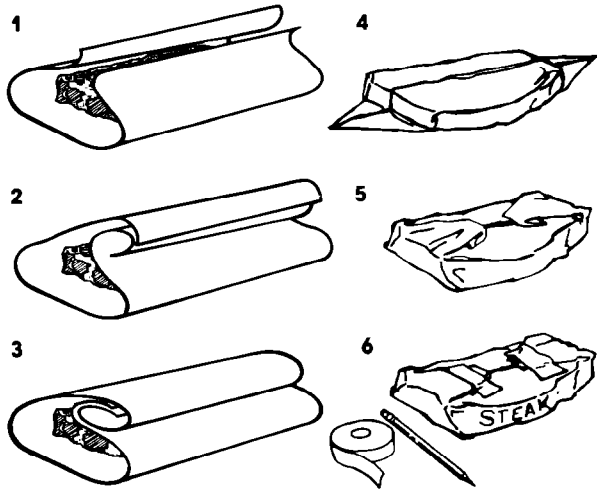

### DO NOT USE:

- Bread wrappers
- Non-polyethylene plastic containers
- Containers without tight lids
- Waxed paper
- Waxed-coated freezer wrap
- Thin, semi-permeable wrap

None of these are totally moisture, air or vapor proof. **The use of these wrappings could cause food odor and taste transfer and drying of frozen food.**

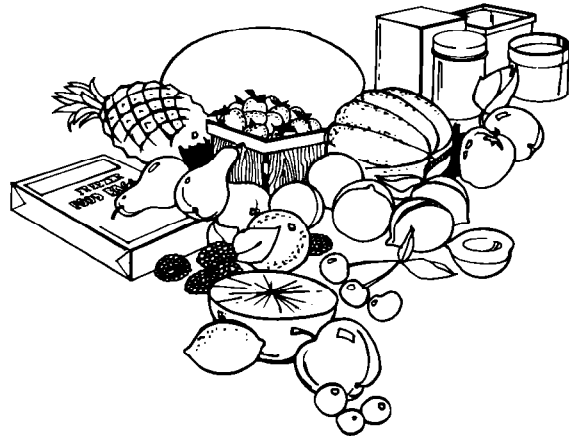

**Freezing Fruits** – Select ripe, blemish-free fruits. Be sure they taste as good as they look. Wash 2 to 3 quarts (liters) at a time and drain. Fruit that stands in water may lose food value and become soggy. Sort, peel, trim, pit and slice as needed.

Pack in rigid wide-mouthed containers or other recommended material. Leave head space to allow liquids to expand during freezing.



**Freezing Vegetables** – Freeze only fresh high-quality vegetables picked when barely mature. For best results, freeze no more than 2 to 3 hours after picking. Wash in cold water, sort and cut into appropriate sizes. Blanch or scald. Pack in recommended container and freeze.

Do not freeze lettuce, celery, carrot sticks, potatoes or fresh tomatoes. All will become limp or mushy. Tomatoes will collapse when thawed.



**Freezing Meats** – The meat you thaw can only be as good as the meat you freeze. Wrap in meal-size packages. Flat cuts or patties should be wrapped individually or in layers separated by a double thickness of freezer wrap.

Make sure store wrappings are moisture and vapor proof. If not, re-wrap meats with one of the wraps recommended under "Packaging."

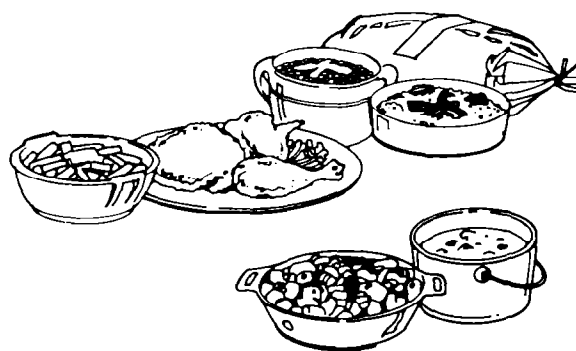

**Freezing Cooked Food** – Prepare cooked foods as you would for the table; shorten cooking time 10 to 15 minutes to allow for additional cooking during reheating. Omit seasonings and part of the liquid. Plan to add them at reheating time. Potatoes should also be added to soup and stew at heating time. Add crumb and cheese toppings at heating time.

Cool as rapidly as possible and freeze at once. Liquid or semi-liquid dishes may be frozen in recommended containers with *head-space*. Casseroles and other more solid foods may be frozen in the baking container. If you don't want to leave your casserole dish in the freezer, line it with foil. Bake, cool, freeze, lift out the foil package, bag it and return to freezer.

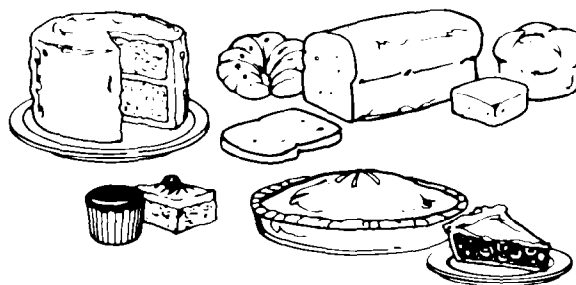

**Freezing Baked Goods** – Wrap baked breads in recommended material. Thaw in wrapping. Unbaked yeast breads can be frozen after the first rising. Punch down, wrap and freeze.

Bake cookies as usual. Cool and freeze on trays, then pack in recommended freezer bags or cartons. Unbaked cookies may be dropped, molded or rolled and frozen on cookie trays. Store in bag or carton; bake without thawing. Refrigerator-type cookies can be wrapped and frozen in roll form. Thaw only enough to slice when ready to bake.

Fruit pies are best frozen unbaked. Bake without thawing. Bake pecan and similar pies before freezing...rich fillings do not freeze solid. Cut steam vents in top crusts when ready to bake.

**IMPORTANT:** Do not expect your freezer to quick-freeze any large quantity of food. Put no more unfrozen food into the freezer than will freeze within 24 hours. (No more than 2 to 3 pounds of food per cubic foot of freezer space.) Leave enough space for air to circulate around packages. Be careful to leave enough room at the front so the door can close tightly.

### FOOD STORAGE CHART

Storage times will vary according to the quality of the food, the type of packaging or wrap used (moisture and vapor-proof), and the storage temperature which should be 0°F (-17.8°C).

Food	Storage Time
<b>FRUITS</b>	
Fruit juice concentrate	12 months
Commercially frozen fruit	12 months
Citrus fruit and juices	4 to 6 months
Others	8 to 12 months
<b>VEGETABLES</b>	
Commercially frozen	8 months
Home frozen	8 to 12 months
<b>MEAT</b>	
Bacon	4 weeks or less
Corned beef	4 weeks or less (Salting meat shortens freezer life)
Frankfurters	1 month
Ground beef, lamb, veal	2 to 3 months
<b>Roasts:</b>	
Beef	6 to 12 months
Lamb and veal	6 to 9 months
Pork	4 to 8 months
Sausage, fresh	1 to 2 months
<b>Steaks and chops:</b>	
Beef	8 to 12 months
Lamb, veal, pork	3 to 4 months
<b>FISH</b>	
Cod, flounder, haddock sole	6 months
Blue fish, salmon	2 to 3 months
Mackerel, perch	2 to 3 months
Breaded fish (purchased)	3 months
Clams, oysters, cooked fish, crab, scallops	3 to 4 months
Alaskan king crab	10 months
Shrimp, uncooked	12 months
<b>POULTRY</b>	
Chicken or turkey, whole or parts	12 months
Duck	6 months
Giblets	2 to 3 months
Cooked poultry w/gravy	6 months
Slices (no gravy)	1 month
<b>MAIN DISHES</b>	
Stews; meat, poultry and fish casserole	2 to 3 months
TV dinners	3 to 6 months

Food	Storage Time
<b>DAIRY PRODUCTS</b>	
Butter	6 to 9 months
Margarine	12 months
<b>Cheese:</b>	
Camembert, Mozzarella, farmer's	3 months
Creamed cottage	<b>DO NOT FREEZE</b>
Cheddar, Edam, Gouda, Swiss, brick, etc.	6 to 8 weeks
Freezing can change texture of cheese.	
Ice cream, ice milk, sherbet	2 months
<b>EGGS</b>	
Whole (mixed)	12 months
Whites	12 months
Yolks	12 months
(Add sugar or salt to yolks or whole mixed eggs)	
<b>BAKED GOODS</b>	
Yeast breads and rolls	3 months
Baked Brown 'N Serve rolls	3 months
Unbaked breads	1 month
Quick breads	2 to 3 months
Cakes, unfrosted	2 to 4 months
Cakes, frosted	8 to 12 months
Fruit cakes	12 months
Cookie dough	3 months
Baked cookies	8 to 12 months
Baked pies	1 to 2 months
Pie dough only	4 to 6 months

Based on U.S.D.A. and Michigan Cooperative Extension Service suggested storage times.

### If electricity goes off

Call the power company. Ask how long power will be off.

- If service is to be interrupted 24 hours or less, **keep both doors closed.** This will help frozen foods to stay frozen.
- If service is to be interrupted longer than 24 hours:
  - Remove all frozen food and store in a frozen food locker. Or...
  - Place 2 lbs (0.9 kg) of dry ice in freezer for every cu. ft. of freezer space. This will keep frozen foods for 2 to 4 days. Wear gloves to protect your hands from dry ice burns.
  - If neither food locker storage nor dry ice is available, use or can perishable food at once.
  - Ice bin may need to be emptied if ice has thawed into a solid mass.
- A full freezer will stay colder longer than a partly filled one. A freezer full of meat will stay cold longer than a freezer full of baked goods. If food contains ice crystals, it may be safely refrozen, although the quality and flavor may be affected. If the condition of the food is poor or if you feel it is unsafe, dispose of it.



# Vacation and Moving Care



## Short vacations...

No need to shut off the refrigerator if you will be away for less than four weeks. Use up perishables; freeze other items.

1. Turn off your ice maker.
2. Shut off the water supply to the ice maker.
3. Empty the ice bin.
4. Make sure all ice crescents are dispensed out of the mechanism.

## Long vacations...

Remove all the food if you are going for a month or more. At least a day ahead, turn off the water supply to the ice maker. When the last load of ice drops, turn off the ice maker. Make sure all ice crescents are dispensed out of the mechanism.

Unplug the refrigerator and clean it...rinse well and dry. Tape rubber or wood blocks to the top of both doors...keeping them open far enough for air to get in. This will keep odor and mold from building up.

### **⚠ WARNING**

#### **Personal Injury Hazard**

**Do not allow children near the refrigerator when the doors are blocked open. They may become injured or trapped.**

To restart refrigerator, see "Using Your Refrigerator" on page 5.

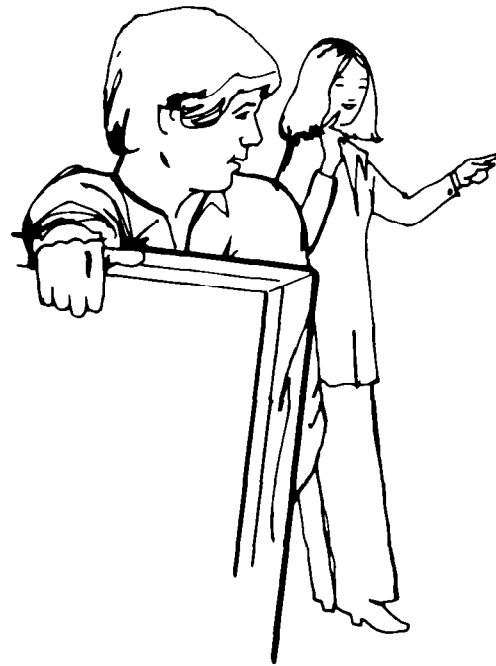

## Moving...

Shut off the ice maker water supply a day ahead of time. Disconnect the water line. After the last supply of ice drops, lift the signal arm to turn off the ice maker. Make sure all ice crescents are dispensed out of the mechanism.

Remove all food. Pack frozen foods in dry ice. Unplug the refrigerator and clean it thoroughly.

Remove everything that comes out. Wrap all parts well and tape them together so they don't shift and rattle.

Also, remove the water supply tank behind the meat drawer by:

1. Disconnecting water inlet and outlet tubes at the top of the tank.
2. Removing three mounting screws from the tank.
3. Draining the tank.

**Re-install the empty tank**, and remember to check for tight water connections when the refrigerator is hooked up at your new location.

Screw in the leveling rollers; tape the doors shut; and tape the electric cord to the cabinet. When you get to your new home, put everything back, level the refrigerator, reconnect the water supply and refer to page 4.

### **Questions?**

...call your COOL-LINE® service assistance telephone number (page 18).



# If you need service or assistance

**We suggest you follow these steps:**

## 1. Before calling for assistance...

Performance problems often result from little things you can find and fix yourself without tools of any kind.

### **If your refrigerator will not operate:**

- Is the power supply cord plugged into a live circuit with proper voltage? (See page 4.)
- Have you checked your home's main fuses or circuit breaker box?
- Is the Refrigerator Control ON?

### **If there is a rattling or jingling noise or unfamiliar sounds:**

- Is something on top of or behind the refrigerator making noise when the refrigerator is running?
- New features on your new refrigerator make new sounds. You may be hearing air flowing from the fans, timer clicks for the defrosting cycle, or defrost water draining in the defrost pan.

### **If your ice maker will not operate:**

- Has the freezer had enough time to get cold? With a new refrigerator, this might take overnight.
- Is the signal arm ON...in the down position?
- Is the water valve turned on? Is water getting to the ice maker?

### **If there is water in the defrost pan:**

- This is normal in hot, muggy weather. The pan can even be half full. Make sure the refrigerator is level so the pan does not overflow.

### **If the light does not work:**

- Have you checked your home's main fuses or circuit breaker box?
- Is the power supply cord plugged into a live circuit with proper voltage? (See page 4.)

### **If a bulb is burned out:**

- See instructions for changing light bulbs on page 8. Use appliance bulbs only.

### **If the motor seems to run too much:**

- Is the condenser free of dust and lint?
- On hot days, or if the room is warm, the motor naturally runs longer.
- If the door has been opened a lot, or if a large amount of food has been put in, the motor will run longer to cool down the interior.

### **Remember:**

Motor running time depends on different things: number of door openings, amount of food stored, temperature of the room, setting of the controls.

Your new refrigerator may be larger than your old one so it has more space to be cooled. It also has a regular freezer instead of a frozen food compartment. All this means better refrigeration and may require more running time than your old one.

## 2. If you need assistance\*..

**Call Whirlpool COOL-LINE® service assistance telephone number. Dial free from anywhere in the U.S.:**

**1-800-253-4304**

and talk with one of our trained consultants. The consultant can instruct you in how to obtain satisfactory operation from your appliance or, if service is necessary, recommend a qualified service company in your area.

If you prefer, write to:

Mr. Donald Skinner  
Director of Consumer Relations  
Whirlpool Corporation  
2000 M-63  
Benton Harbor, MI 49022

Please include a daytime phone number in your correspondence.

## 3. If you need service\*..

 Whirlpool has a nationwide network of authorized Whirlpool<sup>SM</sup> service companies. Whirlpool service technicians are trained to fulfill the product warranty and provide after-warranty service, anywhere in the United States. To locate the authorized Whirlpool service company in your area, call our COOL-LINE® service assistance telephone number (see Step 2) or look in your telephone directory Yellow Pages under:

APPLIANCES - HOUSEHOLD -  
MAJOR - SERVICE & REPAIR

ELECTRICAL APPLIANCES -  
MAJOR - REPAIRING & PARTS

OR

WASHING MACHINES, DRYERS  
& IRONERS - SERVICING

WHIRLPOOL APPLIANCES  
AUTHORIZED WHIRLPOOL SERVICE

SERVICE COMPANIES

XYZ SERVICE CO  
123 MAPLE ..... 999-9999

#### **4. If you need FSP® replacement parts\*...**

FSP is a registered trademark of Whirlpool Corporation for quality parts. Look for this symbol of quality whenever you need a replacement part for your Whirlpool appliance. FSP replacement parts will fit right and work right, because they are made to the same exacting specifications used to build every new Whirlpool appliance.

To locate FSP replacement parts in your area, refer to Step 3 above or call the Whirlpool COOL-LINE service assistance number in Step 2.

#### **5. If you are not satisfied with how the problem was solved\*...**

- Contact the Major Appliance Consumer Action Panel (MACAP). MACAP is a group of independent consumer experts that voices consumer views at the highest levels of the major appliance industry.
- Contact MACAP only when the dealer, authorized servicer or Whirlpool have failed to resolve your problem.

Major Appliance Consumer Action Panel  
20 North Wacker Drive  
Chicago, IL 60606

- MACAP will in turn inform us of your action.

\*When requesting assistance, please provide: model number, serial number, date of purchase, and a complete description of the problem. This information is needed in order to better respond to your request.

# WHIRLPOOL® REFRIGERATOR WARRANTY

RF001

LENGTH OF WARRANTY	WHIRLPOOL WILL PAY FOR
<b>FULL ONE-YEAR WARRANTY</b> From Date of Purchase	FSP® replacement parts and repair labor to correct defects in materials or workmanship. Service must be provided by an authorized Whirlpool <sup>SM</sup> service company.
<b>LIMITED FIVE-YEAR WARRANTY</b> From Date of Purchase	FSP replacement parts for electronic control system if defective in materials or workmanship. (Electronic models only.)
<b>FULL FIVE-YEAR WARRANTY</b> From Date of Purchase	FSP replacement parts and repair labor to correct defects in materials or workmanship in the sealed refrigeration system. These parts are: <ol style="list-style-type: none"> <li>1. Compressor</li> <li>2. Evaporator</li> <li>3. Condenser</li> <li>4. Drier</li> <li>5. Connecting tubing</li> </ol> Service must be provided by an authorized Whirlpool <sup>SM</sup> service company.
<b>WHIRLPOOL WILL NOT PAY FOR</b>	
<p><b>A. Service calls to:</b></p> <ol style="list-style-type: none"> <li>1. Correct the installation of the refrigerator.</li> <li>2. Instruct you how to use the refrigerator.</li> <li>3. Replace house fuses or correct house wiring or plumbing.</li> <li>4. Replace light bulbs.</li> </ol> <p><b>B. Repairs when refrigerator is used in other than normal, single-family household use.</b></p> <p><b>C. Pick up and delivery.</b> This product is designed to be repaired in the home.</p> <p><b>D. Damage to refrigerator caused by accident, misuse, fire, flood, acts of God or use of products not approved by Whirlpool.</b></p> <p><b>E. Any labor costs during limited warranty.</b></p> <p><b>F. Any food loss due to product failure.</b></p>	

WHIRLPOOL CORPORATION SHALL NOT BE LIABLE FOR INCIDENTAL OR CONSEQUENTIAL DAMAGES. Some states do not allow the exclusion or limitation of incidental or consequential damages so this limitation or exclusion may not apply to you. This warranty gives you specific legal rights, and you may also have other rights which vary from state to state.

Outside the United States, a different warranty may apply. For details, please contact your franchised Whirlpool distributor or military exchange.

If you need service, first see the "Service and Assistance" section of this book. After checking "Service and Assistance," additional help can be found by calling our COOL-LINE® service assistance telephone number, 1-800-253-1301, from anywhere in the U.S.



Part No. 1114077 Rev. B  
©1989 Whirlpool Corporation

Printed in U.S.A.

Makers. Dishwashers. Built-In Ovens and Surface Units. Ranges. Microwave Ovens. Trash Compactors. Room Air Conditioners. Dehumidifiers. Automatic Washers. Clothes Dryers. Freezers. Refrigerator-F

