

Have questions about your dryer?

Check your Use and Care Guide for a toll-free number to call, or call your dealer. The dealer is listed in the Yellow Pages of your phone directory under "Appliances — Household — Major — Service and Repair."

When you call, you will need the dryer model number and serial number. Both numbers are on the model/serial rating plate located in the door well behind the dryer door and on front of opening.

Record the numbers here for handy reference:

Model No. _____

Serial No. _____

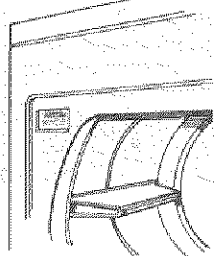

Moving dryer to a new location?

Check with a licensed electrician to confirm that supply voltage at new home matches voltage specified on the model/serial rating plate.

Shut off electrical supply to dryer. Unplug power supply cord and tape it securely to dryer. (Or disconnect power supply cable from dryer.)

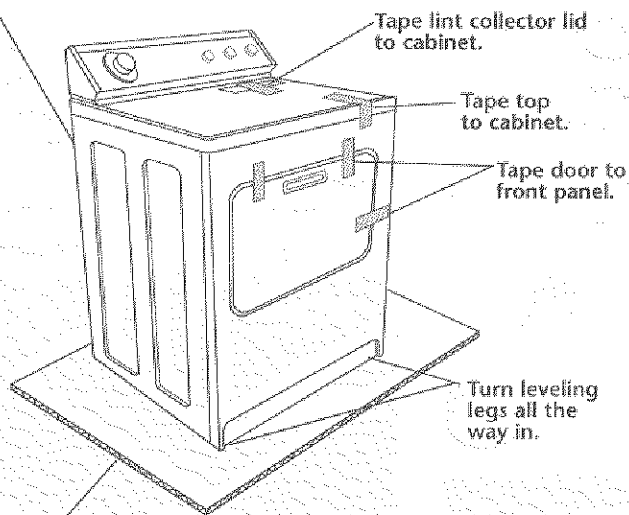

Slide dryer onto cardboard or hardboard before moving it across the floor to prevent damaging floor covering.

Installation Instructions

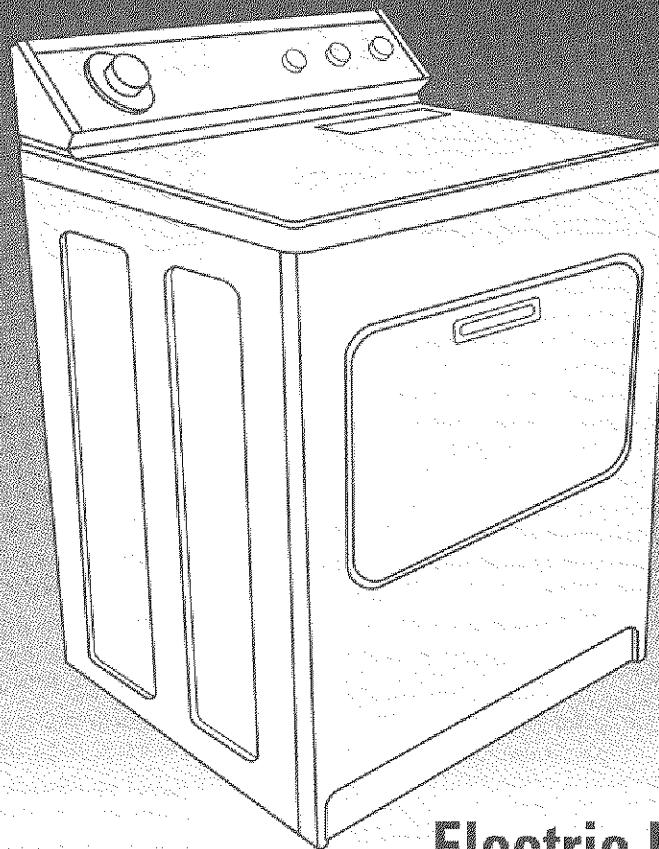

Electric Dryer

Part No. 3397618 Rev. B

IMPORTANT:

Read and save these instructions.

Installer: Leave Installation Instructions with homeowner.

Homeowner: Keep Installation Instructions for future reference.

For best performance, install dryer according to Installation Instructions. Failure to complete installation as instructed could void warranty.

Save Installation Instructions for local electrical inspector's use.

Dryer location and dimensions

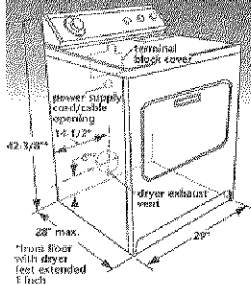

*From floor with dryer feet extended 1 inch

WARNING

Explosion Hazard

Keep flammable materials and vapors, such as gasoline, away from dryer. Place dryer at least 18 inches above the floor for a garage installation. Failure to do so can result in death, explosion, fire, or burns.

For proper drying performance:

The location must provide:

- ✓ Protection from weather and water: Do not store or use dryer where it will be exposed to water and weather.
- ✓ Room temperature above 45°F. If room temperature is below 45°F, automatic cycles may not shut off.
- ✓ Level floor: Maximum slope under entire dryer should not be more than 1 inch. (If slope is greater than 1 inch, install Extended Dryer Feet Kit, Part No. 229810.) Clothes may not tumble properly and automatic sensor cycles may not operate correctly if dryer is not level.
- ✓ Sturdy floor to support dryer weight of 175 pounds.

It is your responsibility to:

- ✓ Observe all governing codes and ordinances.
- ✓ Check code requirements: Some codes limit or do not permit installation of clothes dryers in garages, closets, mobile homes or sleeping quarters. Contact your local building inspector.
- ✓ Comply with the installation specifications and dimensions.
- ✓ Consider spacing requirements for companion appliances.
- ✓ Make sure you have everything necessary for proper installation.
- ✓ Properly install dryer.
- ✓ Contact a qualified installer to insure that the electrical installation meets all national and local codes and ordinances.

Recessed area/closet installation

WARNING — To reduce the risk of fire this appliance **MUST** BE EXHAUSTED OUTDOORS.

Installation clearances

Use recommended clearance for easier installation.

Recommendations/Minimum				
Recessed Exhausted	Back	Sides	Top	Front
Non-exhausted Closet	3 1/4"	1 1/4"	18 7/8"	---

- A clothes dryer produces combustible lint and must be exhausted outdoors. No shelf is permitted above the dryer for non-exhausted units.
- If codes permit, dryer may be installed in a recessed area or closet using dimensions shown.
- Dimensions are in inches and are the minimum allowable.
- Additional spacing should be considered for ease of installation and servicing. Companion appliance spacing should also be considered.

Recessed area installation

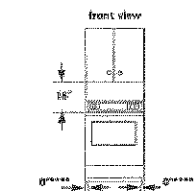

*** Wall, door and floor molding may require additional spacing.

Closet/confined area installation

If a closet door is installed. The minimum unobstructed air openings are required. Louvered doors with equivalent air openings are acceptable.

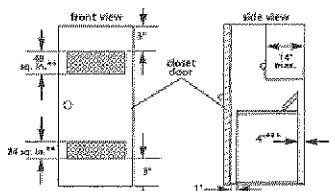

- *** Minimum top and bottom air openings for closet door.
- *** External-elbow requires additional space.

Door clearance

Location must be large enough to fully open dryer door.

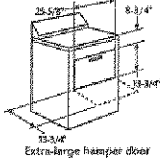
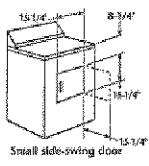
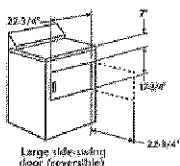
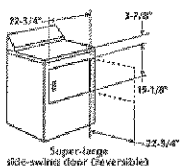

Electrical requirements



If codes permit and a separate ground wire is used, it is recommended that a qualified electrician determine that the ground path is adequate.

Important: Observe all governing codes and ordinances.

A four-wire or three-wire, single phase, 120/240-volt, 60-Hz, AC-only electrical supply (or four-wire or three-wire, 120/208-volt if specified on model/serial rating plate) is required on a separate 30-ampere circuit, fused on both sides of the line. A time-delay fuse or circuit breaker is recommended.

Recommended ground method

It is the personal responsibility and obligation of the customer to contact a qualified electrician to assure that the electrical installation is adequate and is in conformance with the National Electrical Code, ANSI/NFPA 70 — latest edition** and all local codes and ordinances.

Copies of the standards listed above may be obtained from:

**National Fire Protection Association
Batterymarch Park
Quincy, Massachusetts 02269

✓ Exhaust requirements

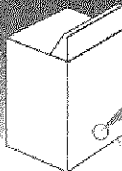

⚠ WARNING



Fire Hazard

Use a heavy metal vent.
Do not use a plastic vent.
Do not use a metal foil vent.
Failure to do so can result in death or fire.

- Do Not use non-metal flexible vent or exhaust hoods with magnetic latches.
- Metal exhaust vent must be four inches in diameter.
- Do Not exhaust dryer into a chimney, furnace, cold air vent, attic or crawl space, or any other vent used for venting.
- Do Not install flexible vent in enclosed walls, ceilings or floors.

Important: Observe all governing codes and ordinances.

It is recommended that you exhaust your dryer to the outside for best performance. Moisture and lint indoors may cause:

- Lint to gather around the dryer where it can be fuel for a fire.
 - Moisture damage to woodwork, furniture, paint, wallpaper, carpet, etc.
 - Housecleaning problems and health problems.
- Dura Safe™ venting products are recommended and are available from your dealer.

Four-inch diameter vent is required.

Rigid or flexible metal exhaust vent must be used. Do Not use plastic or metal foil vent.

Rigid metal vent is recommended to prevent crushing and kinking.

Flexible metal vent must be fully extended and supported when the dryer is in its final position. Remove excess flexible vent to avoid sagging and kinking that may result in reduced air flow.

An exhaust hood should cap the exhaust vent to prevent rodents and insects from entering the home.

Exhaust outlet hood must be at least 12 inches from the ground or any object that may be in the path of the exhaust (such as flowers, rocks or bushes, etc.)



If using an existing exhaust system, clean lint from entire length of system and make sure exhaust hood is not plugged with lint. Replace any plastic or metal foil vent with rigid metal or flexible metal vent. Use clamps to seal all joints. Do Not use duct tape, screws or other fastening devices that extend into the interior of the vent to secure vent.

Service check: Back pressure in any exhaust system used must not exceed 0.6 inches in water column measured with an incline manometer at the point that exhaust vent connects to dryer.

Mobile home installation requirements

If codes permit, this appliance is suitable for mobile home installations. The installation of the dryer must conform to Manufactured Home Construction and Safety Standard, Title 24 CFR, Part 3280 (formerly the Federal Standard for Mobile Homes Construction and Safety, Title 24, HUD Part 280) or latest edition.

The dryer must be exhausted outside.

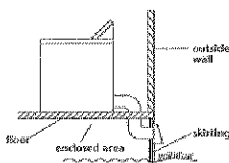

The exhaust vent must be securely fastened to a non-combustible portion of the mobile home structure and must not terminate beneath the mobile home.

Plan the exhaust vent installation

Route the vent

The exhaust outlet is located at the center of the rear of the dryer.

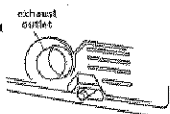

The exhaust vent can be routed up, down, left, right or straight out the back of the dryer. See "Rear access/closet installation" section, Panel A, for general space requirements.

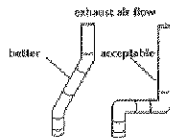
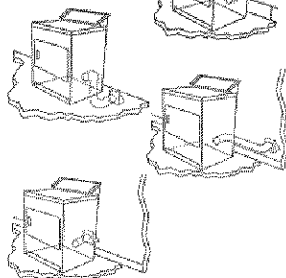
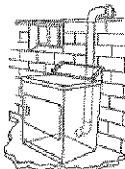

Select the route that will provide the straightest and most direct path outdoors. Plan the installation to use the fewest number of elbows and turns. Avoid making 90° turns.

When using elbows or making turns, allow as much room as possible. Bend vent gradually to avoid kinking.

Determine vent length

The maximum length of the exhaust system depends upon:

- the type of vent (rigid or flexible metal),
- the number of elbows used.

1. See the exhaust vent length chart that matches your type hood for the maximum vent lengths you can use.

Do not use vent runs longer than specified in exhaust vent length charts.

Exhaust systems longer than specified will:

- accumulate lint creating a potential fire hazard.
- shorten the life of the dryer.
- reduce performance, resulting in longer drying times and increased energy usage.

2. Determine the number of elbows you will need.

3. In the column listing the type of metal vent you are using (rigid or flexible), find the maximum length of metal vent on the same line as the number of elbows.

Preferred —



Number of 90° elbows	Maximum length of 4" diameter metal vent	
	Rigid	Flexible (fully extended)
0	64 ft.	36 ft.
1	54 ft.	31 ft.
2	44 ft.	27 ft.
3	35 ft.	25 ft.
4	27 ft.	23 ft.

Acceptable —



Number of 90° elbows	Maximum length of 2-1/2" diameter metal vent	
	Rigid	Flexible (fully extended)
0	58 ft.	28 ft.
1	48 ft.	23 ft.
2	38 ft.	19 ft.
3	29 ft.	17 ft.
4	21 ft.	15 ft.

The maximum lengths using a 2" x 6" rectangular vent with 2 elbows and a 2-1/2" exhaust hood is 8 ft.

For exhaust systems not covered by exhaust vent length charts (such as multiple unit hookups, plenums, and power-assist fans), see Service Manual, Part No. 403197. (To purchase the Service Manual, see your Use and Care Guide for a toll-free telephone number.)



Now start installation (If installing washer and dryer, install dryer first.)

See installation steps for details.

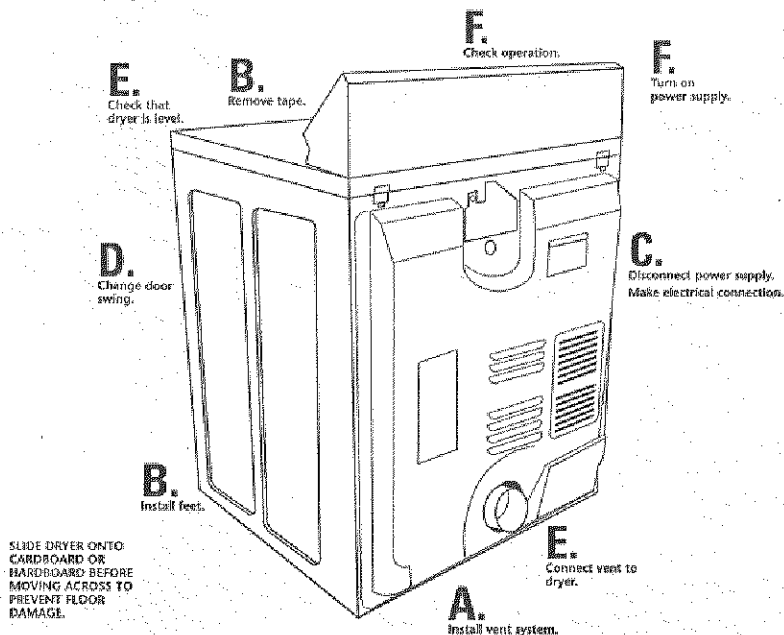

A. Install vent system (new installation)

1. Put on safety glasses and gloves.

2. Install exhaust hood. Use caulking compound to seal exterior wall opening around exhaust hood.

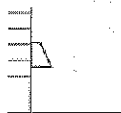

3. Connect exhaust vent to hood. (Exhaust vent MUST fit inside hood.) Secure vent to hood with clamp.

4. Run exhaust vent to dryer location. Use the straightest path possible. (See Panel B.) Use clamps to seal all joints.

B. Prepare dryer

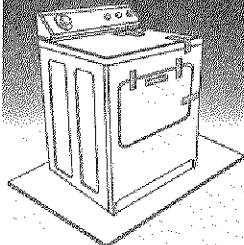

⚠ WARNING

Excessive Weight Hazard

Use two or more people to move and install dryer.

Failure to do so could result in back or other injury.

1. Remove tape from dryer cabinet. Open dryer door and remove tape from dryer drum. (Not all dryer drums are taped.) Remove drying rack, if included. Turn dryer drum counterclockwise to make sure all tape was removed. Wipe drum with damp cloth to remove any dust.



2. Take two cardboard corners from dryer carton and place them on floor in back of dryer. Firmly grasp body of dryer and gently lay it on its back on the cardboard corners.

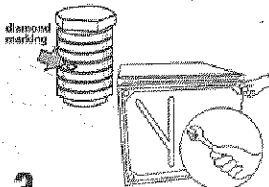

3. Start to screw legs into holes by hand. Use an adjustable wrench or 1" hex-head socket wrench to finish turning legs until you reach the ridge with the diamond marking.

4. Stand dryer up on cardboard or hardboard.

C. Electrical connection



This dryer is manufactured with the cabinet-ground conductor connected to the NEUTRAL (center) of the wiring harness at the terminal block. If local codes do NOT permit this type of connection, use "Four-wire connection" instructions.

GROUNDING INSTRUCTIONS: This appliance must be grounded. In the event of malfunction or breakdown, grounding will reduce the risk of electric shock by providing a path of least resistance for electric current.

If using a power supply cord, the plug must be plugged into an appropriate outlet that is properly installed and grounded in accordance with all local codes and ordinances.

WARNING - Improper connection of the equipment-grounding conductor can result in a risk of electric shock. Check with a qualified electrician or serviceman if you are in doubt as to whether the appliance is properly grounded. Do not modify the plug provided with the appliance - if it will not fit the outlet, have a proper outlet installed by a qualified electrician.

If using a direct wire connection, this appliance must be connected to a grounded metal, permanent wiring system, or an equipment-grounding conductor must be run with the circuit conductors and connected to the equipment-grounding terminal or lead on the appliance.

Power supply cord

⚠ WARNING



Fire Hazard

Use a new UL approved 30 ampere power supply cord.

Use a UL approved strain relief.

Disconnect power before making electrical connections.

Connect neutral wire (white or center wire) to center terminal (silver).

Ground wire (green or bare wire) must be connected to green ground connector.

Connect remaining 2 supply wires to remaining 2 terminals (gold).

Securely tighten all electrical connections.

Failure to do so can result in death, fire, or electrical shock.

1. Disconnect the power supply.

2. Remove hold-down screw and terminal block cover.

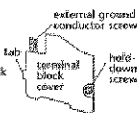

Direct wire

⚠ WARNING



Fire Hazard

Use 10 gauge solid copper wire.

Use a UL approved strain relief.

Disconnect power before making electrical connections.

Connect neutral wire (white or center wire) to center terminal (silver).

Ground wire (green or bare wire) must be connected to green ground connector.

Connect remaining 2 supply wires to remaining 2 terminals (gold).

Securely tighten all electrical connections.

Failure to do so can result in death, fire, or electrical shock.

3. Assemble 3/4" strain relief clamp sections on strain relief into the hole below terminal block opening. Tighten strain relief screws just enough to hold the two clamp sections together. Install power supply cord/cable through the strain relief.



Complete installation following instructions for your type of connection:

- Four-wire (recommended method)
- Three-wire (if four-wire is not available)

Four-wire connection...



Four-wire receptacle (required for mobile homes)

POWER SUPPLY CORD

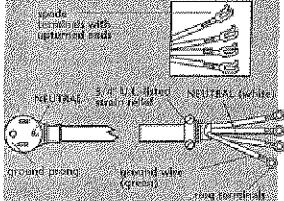

Four-wire power supply cord must have four, No. 10 copper wires and match a four-wire receptacle of NEMA Type 14-30R. The fourth wire (ground conductor) must be identified with a green cover and the neutral conductor by a white cover.

4. Remove center terminal block screw.
5. Remove appliance ground wire (green with yellow stripes) from external ground connector screw. Fasten under center, silver-colored terminal block screw.
6. Connect ground wire (green) of power supply cord to external ground conductor screw. Tighten screw.
7. Connect neutral wire (white or center) of power supply cord under center screw of the terminal block. Tighten screw.
8. Connect the other wires to outer terminal block screws. Tighten screws.
9. Tighten strain relief screws.
10. Insert tab of terminal block cover into slot of the dryer rear panel. Secure cover with hold-down screw.

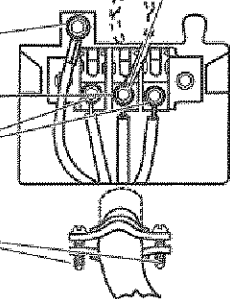

DIRECT WIRE

Preparing the wire:

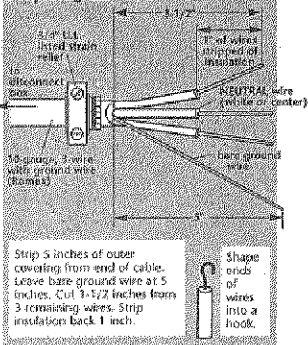

4. Remove center terminal block screw.
5. Remove appliance ground wire (green with yellow stripes) from external ground connector screw. Fasten under center, silver-colored terminal block screw.
6. Connect the ground wire (bare) of the power supply cable to the external ground conductor screw. Tighten screw.
7. Place the hooked end of the neutral wire (white or center) of power supply cable under the center screw of terminal block (hook facing right). Squeeze hook ends together. Tighten screw.
8. Place the hooked ends of the other power supply cable wires under the outer terminal block screws (hook facing right). Squeeze hooked ends together. Tighten screws.
9. Tighten strain relief screws.
10. Insert tab of terminal block cover into slot of dryer rear panel. Secure cover with hold-down screw.

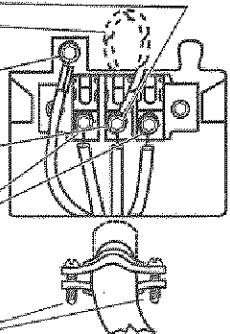

Three-wire connection...



Three-wire receptacle

POWER SUPPLY CORD

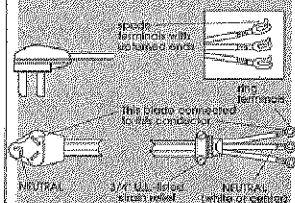

Three-wire power supply cord must have three, No.-10 copper wires and match a three-wire receptacle of NEMA Type 10-30R.

Where local codes permit connecting cabinet-ground conductor to neutral wire:

- Loosen or remove center terminal block screw.
- Connect the neutral wire (white or center) of power supply cord to the center, silver-colored terminal screw of the terminal block. Tighten screw.
- Connect the other wires to outer terminal block screws. Tighten screws.
- Tighten strain relief screws.
- Insert tab of terminal block cover into slot of dryer rear panel. Secure cover with hold-down screw.

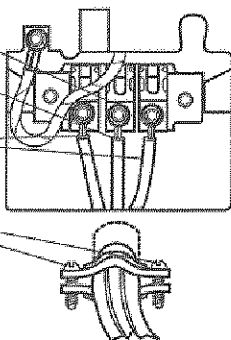

DIRECT WIRE

Preparing the wire:

Three-wire with ground wire: Bare wire cut short. Wire is inserted through direct wire cable.

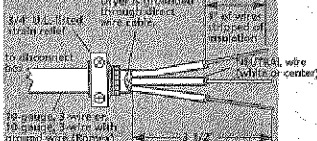

Strip 3-1/2 inches of outer covering from end of cable. Strip insulation back 1 inch, if using 3-wire cable with ground wire (BOMEX). Shape ends of wires into a hook.

Where local codes permit connecting cabinet-ground conductor to neutral wire:

- Loosen or remove center terminal block screw.
- Place the hooked end of the neutral wire (white or center) of power supply cable under the center screw of the terminal block (hook facing right). Squeeze hooked end together. Tighten screw.
- Place the hooked ends of the other power supply cable wires under the outer terminal block screws (hook facing right). Squeeze hooked ends together. Tighten screws.
- Tighten strain relief screws.
- Insert tab of terminal block cover into slot of dryer rear panel. Secure cover with hold-down screw.

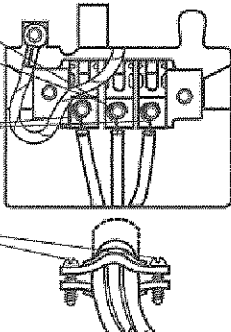

DIRECT WIRE OR POWER SUPPLY CORD

Three-wire power supply cord must have three, No.-10 copper wires and match a three-wire receptacle of NEMA Type 10-30R.

Direct wire power supply cable must be prepared as shown in "Preparing the wire" of the three-wire connection, direct-wire, steps above.

If codes permit and a separate ground wire is used, it is recommended that a qualified electrician determine that the ground path is adequate.

Where local codes Do Not permit connecting cabinet-ground conductor to neutral wire:

- Remove center terminal block screw.
- Remove the appliance harness ground wire (green with yellow stripes) from the external ground connector screw. Connect appliance harness ground wire and the neutral wire (white or center) of the power supply cord/cable under the center, silver-colored terminal block screw. Tighten screw.
- Connect the other wires to outer terminal block screws. Tighten screws.
- Tighten strain relief screws.
- Insert tab of terminal block cover into slot of dryer rear panel. Secure cover with hold-down screw.
- After reattaching the terminal cover, connect a separate copper ground wire from the external ground connector screw to an adequate ground.

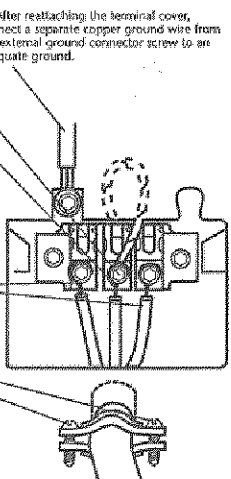

D. Change door swing

Available on Super-wide side-swing and Large side-swing door models only. If not reversing door swing, skip ahead to "Level and exhaust dryer" steps.

Be careful not to scratch or chip paint.

1. Place a large towel or soft cloth (A) on top of dryer.

2. Open dryer door. Remove bottom screws from cabinet side of hinges (B). Loosen (do not remove) top screws from cabinet side of hinges.

3. Lift door until top screws in cabinet are in large part of hinge slot. Pull door forward off screws. Set door (handle side up) on top of dryer. Remove top screws from cabinet.

Complete door swing change following the instructions for your type door.

Super-wide side swing door

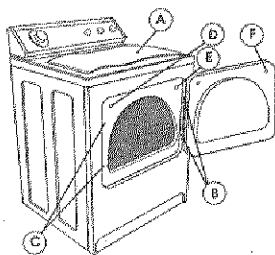

4. Remove screws attaching hinges to door.

5. Remove screws at top, bottom and side of door. Holding door over towel on dryer, grasp sides of outer door and carefully lift to separate it from inner door. Do NOT pry apart with putty knife. Do NOT pull on door seal or plastic door catches.



6. Turn and reattach outer door panel to inner door panel so handle is on the side where hinges were just removed. Be careful to keep cardboard spacer centered between inner and outer doors.



7. Attach door hinge to door so large part of hinge slot is at bottom of hinge.

8. Carefully remove 4 hinge hole plugs (C) on left side of cabinet. Insert plugs into hinge holes (B) on right side of cabinet.

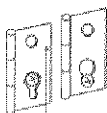

9. Insert screws in bottom holes on left side of cabinet. Tighten screws halfway. Position door so large end of door hinge slot is over screws. Slide door up so screws are in bottom of slots. Tighten screws. Insert and tighten top screws in hinges.

10. Remove door strike (D) from cabinet. Remove door strike plug (E). Insert door strike in new hole and secure with screw. Insert door strike plug in original door strike hole and secure with screw.

11. Slowly close door and check that door strike aligns with door catch (F). If door does not close completely, slide door catch left or right within slot until strike snaps into catch.

Large side swing door

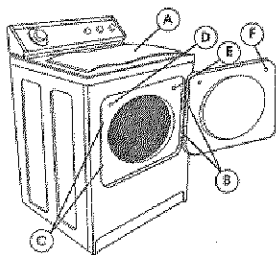

4. Carefully remove 4 hinge hole plugs (C) on left side of cabinet. Insert plugs into hinge holes (B) on right side of cabinet.



5. Insert screws in bottom holes on left side of cabinet. Tighten screws halfway. Position door so large end of door hinge slot is over screws. Slide door up so screws are in bottom of slots. Tighten screws. Insert and tighten top screws in hinges.

6. Remove door strike (D) from cabinet. Remove door strike plug (E). Insert door strike in new hole and secure with screw. Insert door strike plug in original door strike hole and secure with screw.

7. Slowly close door and check that door strike aligns with door catch (F). If door does not close completely, slide door catch left or right within slot until strike snaps into catch.

E. Level & exhaust the dryer

Dryer must be level to reduce noise and assure proper performance.

Slide dryer onto cardboard or hardboard before moving across floor to prevent floor damage.

1. Move dryer close to its permanent location. Leave enough room to connect exhaust vent. Remove cardboard or hardboard from under dryer.

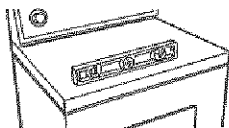

2. Check levelness of dryer by placing a level on top of dryer, first side to side, then front to back. If dryer is not level, adjust dryer legs up or down.

If legs are not long enough to level dryer, order Extended Dryer Feet Kit, Part No. 279810 (sold two legs per kit), from your dealer.

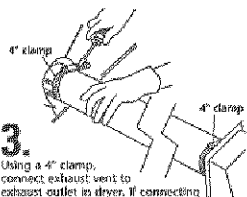

3. Using a 4" clamp, connect exhaust vent to exhaust outlet in dryer. If connecting to existing exhaust vent, make sure the vent is clean. The dryer exhaust vent must fit over the dryer exhaust outlet and inside the exhaust hood. Make sure exhaust vent is secured to exhaust hood with a 4" clamp.

4. Move dryer into final position. Do not crush or kink exhaust vent. Make sure dryer is level.

F. Check operation

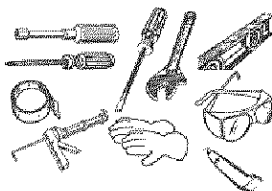

1. Check that you:

 - ✓ did not skip any steps.
 - ✓ installed all parts.
 - ✓ properly installed dryer legs.
 - ✓ leveled dryer.
 - ✓ have all the tools you started with.

2. Plug power supply cord into grounded outlet or connect direct wire to power supply. Turn power supply on.

3. Read the Use and Care Guide to fully understand your new dryer. Select a full heat cycle (not the air cycle) and start dryer. After five minutes, open dryer door. You should feel heat inside dryer.

If dryer does not operate properly, check the following:

- ✓ electrical supply is connected.
- ✓ house fuse is intact and tight, or circuit breaker has not tripped.
- ✓ dryer door is closed.
- ✓ controls are set in a running or "On" position.
- ✓ start button has been pushed firmly.

If dryer makes an unusual noise, check the following:

- ✓ dryer is level.

CRUSH RESISTANT

Dura Safe™ SURE CONNECT™ Vent Kit

Kits Make Installation Easy

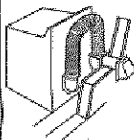

Part #4306020

- ◆ Provides 4 1/2" clearance between dryer and wall
- ◆ Snap-Lock fittings
- ◆ Total kit length 8 feet
- ◆ Additional vent can be snapped between sections for longer runs

Kit Contains:

- 2-4' vent sections with attached close elbows
- 1-Wall plate for close clearance installations
- 2-4" clamps

"As easy as 1-2-3"



Step 1
Clamp one end of vent section to wall and one to dryer.



Step 2
Extend vent upward, offset to top of dryer, then push dryer to wall.



Step 3
Push over the top, snap vent together.

Dura Safe and Sure Connect are trademarks of Midland, U.S.A.

Periscopes For Offset Outlets, Tight Installations

- ◆ Provides 2 1/2" clearance between dryer and wall
- ◆ Great for closet installations
- ◆ 0"-18", 18"-29" or 29"-50" periscopes include one male snap-lock fitting, one extra long draw-band collar and one clamp

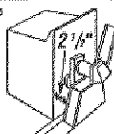

0"-18": Part #4306037
18"-29": Part #4306011
29"-50": Part #4306014

0"-18" Periscope

- ◆ Use when vent outlets overlap or are offset
- ◆ Excess length can be trimmed to fit



Part #4286032

18"-29" and 29"-50" Periscope

- Swivel collar wall connection
- Telescoping sections
- beveled edges allow corner installations
- Sections separate, fittings can face same or opposite
- Swivel collar
- Extra long band-clamp for dryer connection

18"-29": Part #4306011

29"-50": Part #4306014

For more information, or to easily place your order, call

1-800-442-9991

To have your venting professionally installed, call

1-800-253-1301

for the nearest authorized service provider.



Before you start:

Your safety and the safety of others is very important.

We have provided many important safety messages in this manual and on your appliance. Always read and obey all safety messages.



This is the safety alert symbol. This symbol alerts you to hazards that can kill or hurt you and others. All safety messages will be preceded by the safety alert symbol and the word "DANGER" or "WARNING". These words mean:

⚠ DANGER

You will be killed or seriously injured if you don't follow instructions.

⚠ WARNING

You can be killed or seriously injured if you don't follow instructions.

All safety messages will identify the hazard, tell you how to reduce the chance of injury, and tell you what can happen if the instructions are not followed.

Check that you have everything necessary for correct installation. Proper installation is your responsibility.

Tools needed:

- 1/4" nut driver or socket wrench
- Phillips screwdriver
- flat-blade screwdriver
- adjustable wrench that opens to 1" or 1 1/2" hex-head socket wrench (for adjusting dryer feet)
- level
- caulking gun and compound (for installing new exhaust vent)
- gloves
- safety glasses
- knife

Tools needed to change door swing:

- Phillips screwdriver
- soft cloth or towel

Parts supplied:

Remove parts package from dryer drum. Check that all parts were included.



4 leveling legs

Parts needed:

Check local codes and see electrical and venting requirements, Panel B, before purchasing parts. Determine if you will need to purchase a power supply cord kit or power supply cable.





Electrical

If using a power supply cord:

Dryer power supply cord must be:

- U.L.-listed
- 120/240-volt minimum
- 30-ampere
- Type SRD or SRDT
- At least 4 feet long

The wires that connect to the dryer must end in ring terminals or spade terminals with upturned ends.

If your outlet looks like this:	Choose this power supply cord:
 4-wire receptacle (14-30R)	 4-wire power supply cord with ring or spade terminals and U.L.-listed strain relief
 3-wire receptacle (10-30R)	 3-wire power supply cord with ring or spade terminals and U.L.-listed strain relief

If connecting by direct wire:

Power supply cable must match power supply (4-wire or 3-wire) and be:

- flexible armored or non-metallic sheathed copper cable (with ground wire). All current-carrying wires must be insulated. See Panel D.
- 10-GAUGE SOLID COPPER WIRE. (Do not use aluminum.)
- at least 4 feet long.

Venting

⚠ WARNING



Fire Hazard

- Use a heavy metal vent.
- Do not use a plastic vent.
- Do not use a metal foil vent.
- Failure to do so can result in death or fire.

Four-inch heavy metal exhaust vent and clamps must be used. Dura Safe™ vent products are recommended.

Dura Safe vent products can be purchased from your dealer or by calling Whirlpool Parts & Accessories 1-800-442-9991, Mon-Fri: 8am to 9pm (CST), Sat: 9am to 4:30pm (CST). Visit our internet site at <http://www.whirlpoolappliances.com/accessories> See Panel G for more information.

Exhaust hood

Do Not use exhaust hoods with magnetic latches.

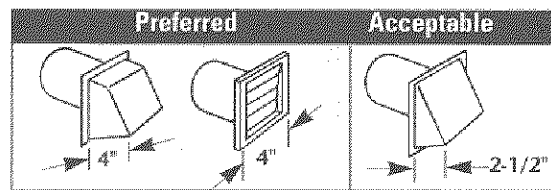

Mobile home installations require:

- Mobile Home Installation Kit, Part Number 346764*
- Metal exhaust system hardware*

Floors sloped greater than 1 inch:

Require Extended Dryer Feet Kit, Part No. 279810*

*Available for purchase from your dealer.