

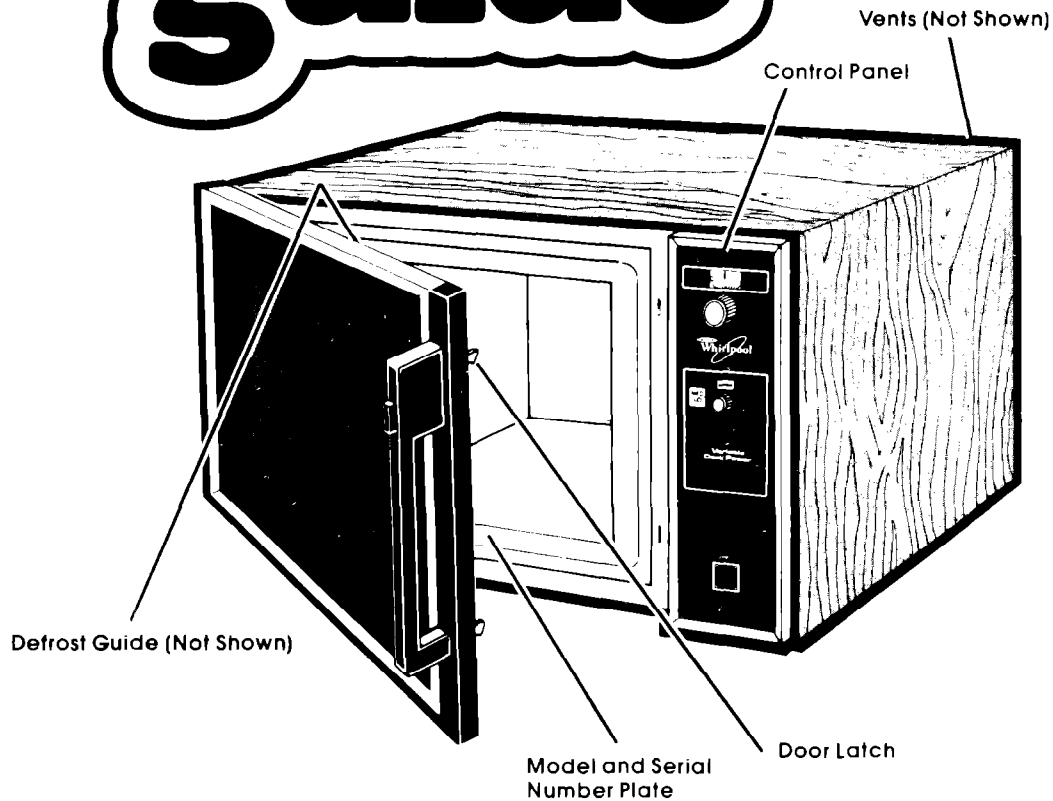

Microwave Oven Model MW8200XL

use & care guide



Copy Your Model and Serial Numbers Here

If you need service or call with a question, have this information ready.

1. **Complete** Model and Serial Numbers (from the plate just behind the microwave oven door on the oven frame).
2. Purchase date from sales slip (or date installed).

Copy this information in these spaces. Keep this book, your warranty, and sales slip together in a handy place.

.....
Model Number

.....
Serial Number

.....
Purchase Installation Date

.....
Service Company and Phone Number

Contents

	Page		Page
Responsibilities	2	Important Information	6
Installation	2	How Microwave Ovens Work	8
Proper, Safe Use	3	Replacing the Light Bulb	9
Precautions to Avoid Possible		Building In Your Microwave Oven ...	9
Exposure to Excessive		If You Need Service or Assistance ...	10
Microwave Energy	3	1. Before Calling For Assistance ...	10
Using Your Microwave Oven	4	2. If You Need Assistance	10
Setting the Controls	4	3. If You Need Service	10
Defrosting	5	4. If You Have a Problem	10
Cleaning the Microwave Oven ...	5		

Your responsibilities...

Fill out and return the "Microwave Registration Card" attached to the oven door.

Installation

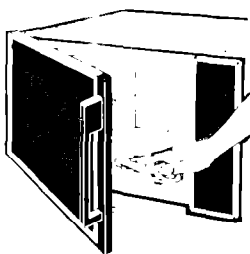

1. Empty the microwave oven and clean inside it with a soft, damp cloth.

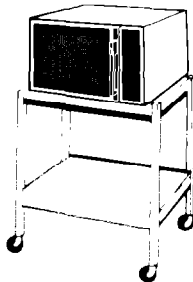

2. Put the oven on a cart, counter, table or shelf that is strong enough to hold the oven. **(The control side of the unit is the heavy side. Handling can be tricky.)**

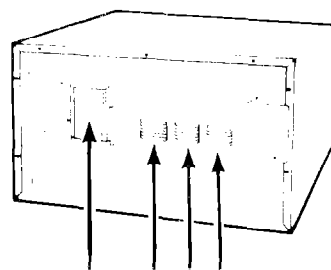

3. Do not block vents on back of the oven. Blocking vents can cause poor cooking results.

4. For your safety, **this oven must be grounded. DO NOT REMOVE THE THIRD PRONG FROM THE PLUG.** You must have a qualified electrician put in the right outlet if yours does not have the 3-prong plug-in, or if the outlet is not grounded according to National Electrical Codes and local codes or ordinances. The outlet must supply 120 volts, 60 Hz, A.C. When the oven is on, it will use about 1375 watts. It should not share a circuit with another appliance.

5. Put about one cup (250 ml) of cold water in a glass container in the oven. Close the door. Make sure it locks. Follow the directions on page 4 to set the oven to COOK for 1 1/2 minutes. When the time is up, the water should be heated.

6. Fill out and return the "Microwave Registration Card" attached to the oven door. If the card is missing, please send the model and serial number of your microwave oven, with your name and address to...

Whirlpool Corporation
Microwave Registration Department
Administrative Center
2000 U.S. 33 North
Benton Harbor, Michigan 49022

This information will help us reach you if there is ever a need to pass along information about your microwave oven.

Proper, safe use

Your microwave must be...

- Installed according to the installation instructions.
- Protected from the weather.
- Used only for jobs expected of home microwave ovens.
- Used only by people who can operate it properly.
- Kept clean and in good repair.

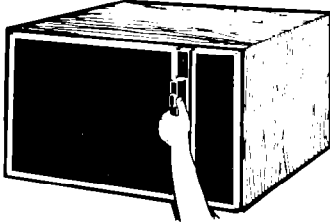

NEVER start the oven when it's empty. The oven can be damaged.



DO NOT cook or reheat whole eggs in the microwave oven. Steam build-up can cause an egg to burst. Damage to the oven or injury to the user may result.



DO NOT use the oven until you have read and understand **ALL** the information on safe use.

PRECAUTIONS TO AVOID POSSIBLE EXPOSURE TO EXCESSIVE MICROWAVE ENERGY...

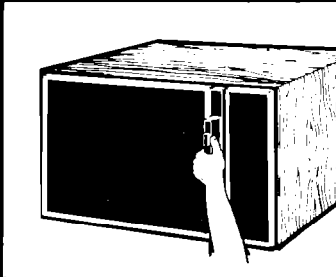

DO NOT attempt to operate this oven with the door open since open-door operation can result in harmful exposure to microwave energy. It is important not to defeat or tamper with the safety interlocks.

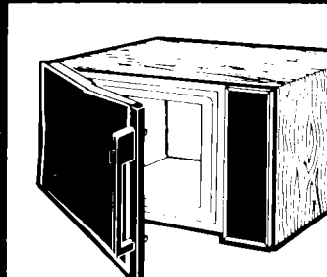

DO NOT operate the oven if it is damaged. It is particularly important that the oven door close properly and that there is no damage to the

- (1) Door (bent),
- (2) Hinges and latches (broken or loosened),
- (3) Door seals and sealing surfaces.

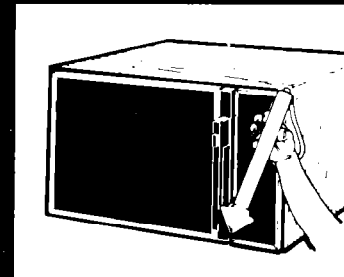

The microwave oven should be checked for microwave leakage by qualified service personnel after a repair is made.

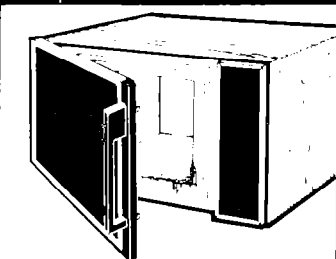

DO NOT place any object between the oven front face and the door or allow soil or cleaner residue to accumulate on sealing surfaces.

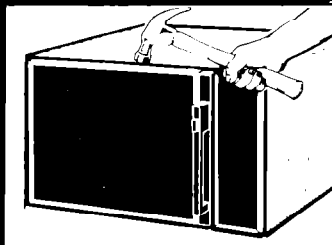

The oven should not be adjusted or repaired by anyone except properly qualified service personnel.

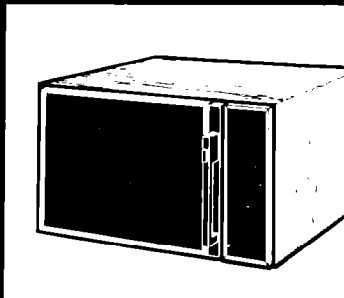

DO NOT operate the microwave oven if the door glass is broken.

DO NOT operate the microwave oven with the outer cabinet removed.

Using your microwave oven

Microwave Oven Controls

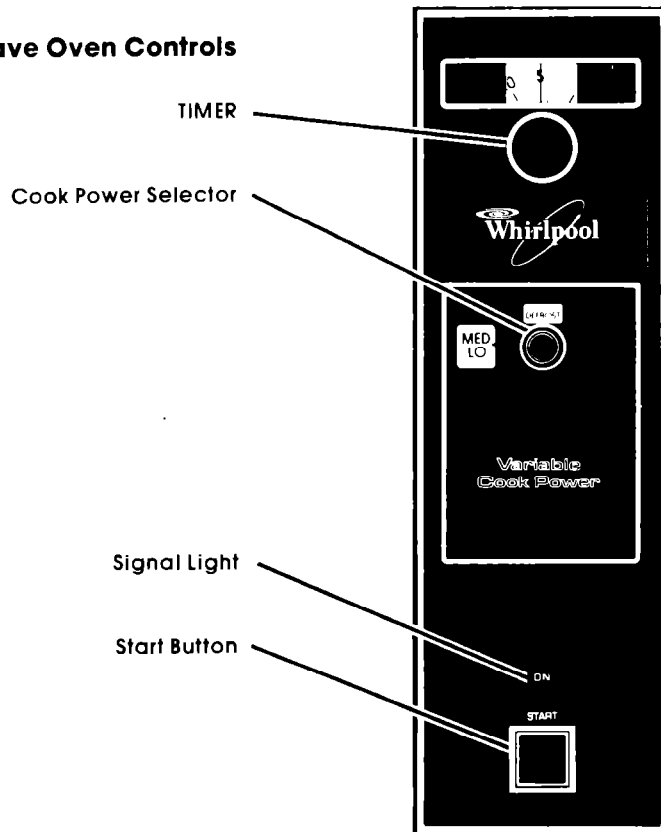

SETTING THE CONTROLS

Be sure you understand the basics of microwave oven cooking before you start. Start with recipes from your MICRO MENU Cookbook. Follow the directions carefully.

NEVER START THE OVEN WHEN IT'S EMPTY. The oven can be damaged. For testing, use at least a cup of water

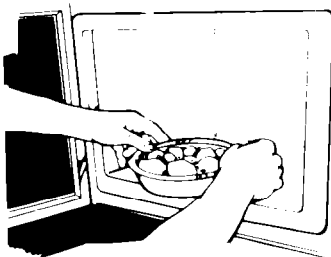

Be sure you have read and understand the directions.

1. Put food in the oven

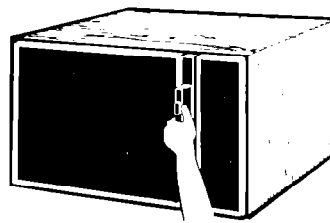

2. Close the door. Make sure it locks. The oven won't work if the door isn't closed tightly.

3. Set cooking times up to 35 minutes by turning the timer knob clockwise. The oven light will come

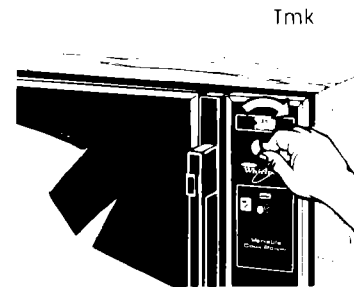

on. Turn counterclockwise to reduce time.

Each mark is 15 seconds for the first 5 minutes. After 5 minutes, each mark is 1 minute.

To set time for less than 1 minute, turn timer past 1 minute then to desired time.

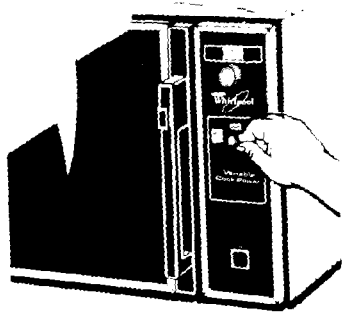

4. Set Cook Power to desired setting from HI to LO. Some recipes require different Cook Powers for best results. (See chart.) The lower the Cook Power, the slower the cooking.

COOK POWER CHART

Recipes in the MICRO MENUS[®] Cookbook use Cook Power settings from HI to LO. Recipes in other books and magazines may use different percentages of cooking power. The following chart will be helpful:

HI	– 100% of full power
MED-HI	– 70% of full power
MED	– 50% of full power
MED-LO	– 30% of full power
(DEFROST)	
LO	– 15% of full power

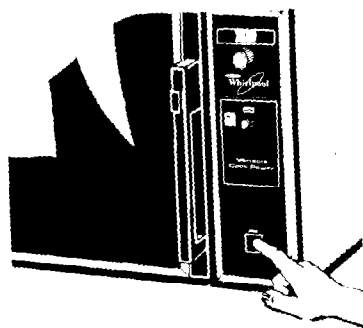

5. Push the START Button. The oven light will stay on. You will hear a fan running during oven operation.

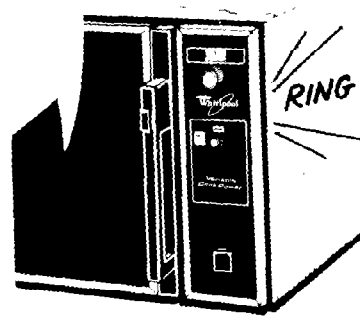

6. When the set time is up, the oven will shut off automatically. You will hear a bell, the light will go off and the fan will stop.

TO STOP THE OVEN

1. Turn the timer knob counterclockwise to 0.
OR
2. Open the oven door.

TO RESTART THE OVEN

1. Close the oven door.
2. Set timer (if needed). To set timer for less than 1 minute, turn timer past 1 minute then to desired time.
3. Push the START Button.

DEFROSTING

For defrosting, set Cook Power Control to DEFROST (MED-LO) setting. See the Defrost Guide inside the oven door or your MICRO MENUS Cookbook for suggested defrost times.

Trmk.

CLEANING THE MICROWAVE OVEN



Wipe often with warm sudsy water and a soft cloth or sponge.

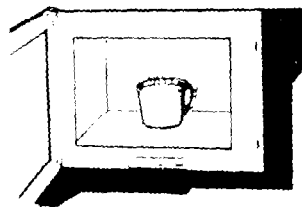

For stubborn soil, boil a cup of water in the oven for 2 or 3 minutes. Steam will soften the soil.

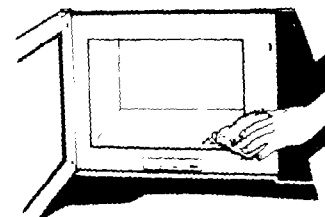

Be sure to clean the areas where the door and oven frame touch when closed. Rinse well.

Do not use abrasive cleaners or steel wool pads.

IMPORTANT INFORMATION

Before you start using your microwave oven, read this section carefully. *This information will help you avoid damage to your oven.*

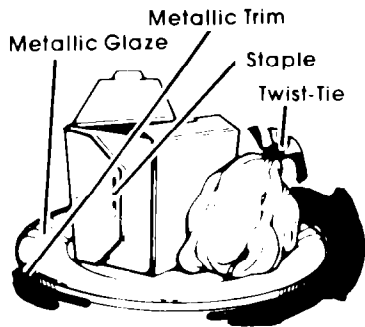

Cooking in metal containers **can damage the oven**. So can containers with **hidden metal** (twist-ties, foil-lining, staples, metallic glaze or trim). *Test dinnerware or cookware before using.*

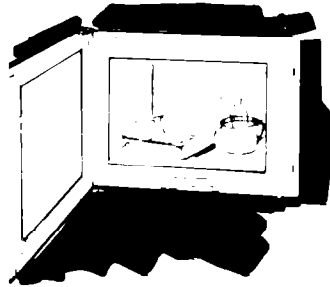

*To test a dish for safe use, put it into the oven with a cup of water **beside** it. Cook on high Cook Power for one minute. **If the dish gets hot and the water stays cool, do not use it.***



NEVER COOK OR REHEAT A WHOLE EGG. Slice hard boiled eggs before heating. Steam build-up in whole eggs may cause them to burst and possibly damage the oven.



Paper can char or burn, and some plastics can melt if used when heating foods for more than 4 minutes.

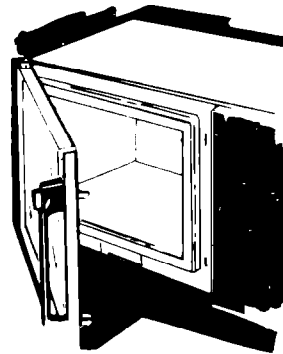

NEVER start a microwave oven when it's empty. The oven can be damaged. If you experiment, put a container of water in the oven.

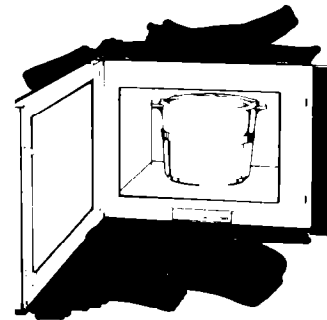

Don't let anything touch the top of the oven cavity.



Rough or harsh cleaners can scratch or dull the oven finish. **DO NOT USE THEM.**

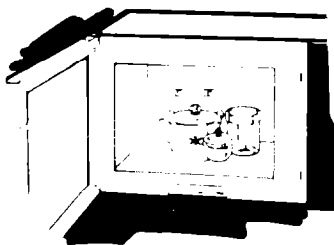

DO NOT store things in the oven.



Overcooking some foods can cause them to scorch or flame...especially foods like potatoes, popcorn, snacks, etc. See the MICRO MENUS[®] Cookbook.

Tmk

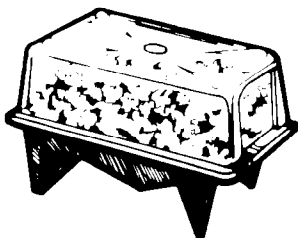

Make popcorn only in poppers designed for use in microwave ovens. Follow popper directions. Results are the popper manufacturer's responsibility.



Liquids heated in certain containers may overheat. The liquid may then splash out with a loud noise. This does not harm the oven, but you should not use such containers to heat liquids again.



DO NOT OVERCOOK POTATOES. At the end of the recommended cooking time they should be slightly firm. Wrap in foil and set aside for 5 minutes. They will finish cooking while standing.

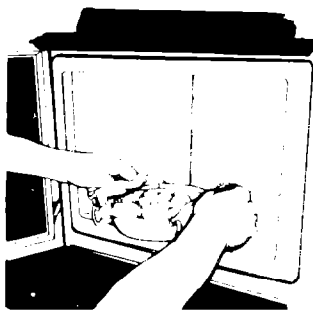

USE HOT PADS. Microwave energy does not heat containers, but the hot food does



Follow MICRO MENUS[®] Cookbook directions carefully. If using a different cookbook, you may need to experiment with times and Cook Powers

- Double-check all settings.
- Use the oven only for defrosting, cooking or reheating.

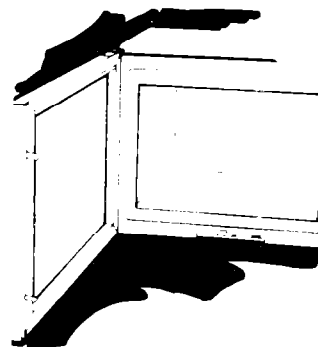

It is normal for the inside of the oven door to look wavy after the oven has been running for a while.

It is normal for the signal lights to flicker while the microwave oven is on.



If your electric power line voltage is less than the normal 120 volts, cooking times may be longer.

HOW MICROWAVE OVENS WORK

Microwave ovens are safe. Microwave energy is not hot. It causes food to make its own heat, and it's this heat that cooks the food.

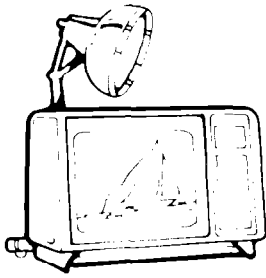

Microwaves are like TV waves or light waves. You can't see them, but you can see what they do.

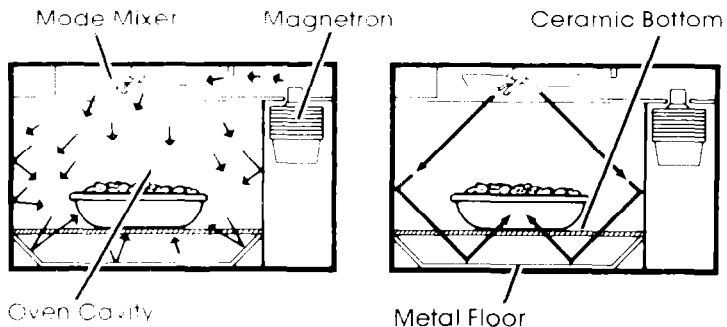

A magnetron in the microwave oven produces microwaves. The microwaves move into the oven where they are scattered or stirred by a mode mixer (like a fan). Microwaves bounce off metal oven walls and are absorbed by food.

The ceramic bottom of your microwave oven lets microwaves through. Then they bounce off a metal floor, back through the ceramic bottom and are absorbed by the food.

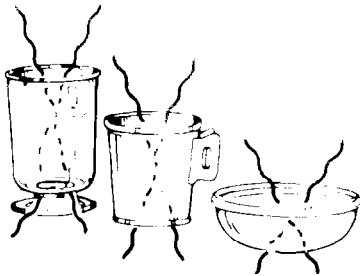

Microwaves pass through glass, paper, and plastic without heating them so food absorbs the energy. Microwaves bounce off metal pans so food does not absorb the energy.

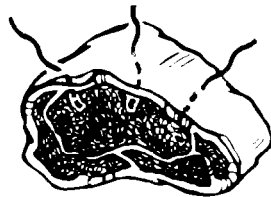

Microwaves may not reach the center of a roast. The heat around the outside is what cooks the roast all the way through. This is one of the reasons for letting some foods (roasts, baked potatoes) stand for a while after cooking, or for stirring some foods during the cooking time.



The microwaves disturb water molecules in the food. As the molecules bounce around bumping into each other, heat is made, like rubbing your hands together. This is the heat that cooks.

REPLACING THE LIGHT BULB

1. Unplug the power cord.
2. Remove holding screw on access panel.
3. Remove the light bulb from its socket.
4. Replace bulb with a 40-watt **appliance** bulb.
5. Replace the access panel and holding screw.
6. Plug in the power cord.

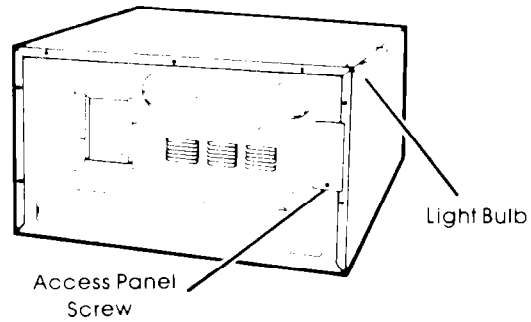

Building in your microwave oven

Your microwave oven is not limited to carts, counters or tables. Custom installations are made easy with kits available from your dealer.

1. Build the microwave oven into a cabinet or wall by itself or over built-in single ovens in the Whirlpool RDE, REE, RGE, RB and SB model series or Imperial 7200 single gas ovens.
2. Attach the microwave oven to a wall by itself or with cabinets over it.
3. Put the microwave oven on the MICRO SHELF[®] Hood over a cooktop. The hood is available ducted or as a recirculating hood, and includes cooktop lights.

Ask your dealer for details on...

- RCK803 (832849) – 30-inch Built-in Kit
- RCK805 (832856) – 25 $\frac{1}{4}$ -inch Built-in Kit
- RCK807 (832850) – 27-inch Built-in Kit
- RCK710 (832763) – Wall Mount Kit
- RCK811 (832875) – Wall Mount Vent Grille and Filler Kit
- RCK713 (832769) – Wall Mount Cookbook Storage Cabinet
- RH3330XL – MICRO SHELF Hood

If you need service or assistance, we suggest you follow these four steps:

1. Before calling for assistance...

Performance problems often result from little things you can find and fix yourself without tools of any kind.

If nothing operates:

- Is the oven correctly plugged into a live circuit with the proper voltage? (See page 2.)
- Have you checked the main fuse or circuit breaker box?

If the microwave oven will not run:

- Is the timer set?
- Is the door firmly closed and latched?
- Did you push START?
- Did you follow the directions on pages 4 and 5 **exactly**?

If microwave cooking times seem too long:

- Is the electric supply to your home low or lower than normal? Your electric company can tell you if the line voltage is low.
- Is the Cook Power at the recommended setting?
- Are you allowing for more time when cooking more food at one time?

2. If you need assistance * ...

Call the Whirlpool COOL-LINE[®] service assistance telephone number. Dial free from:

Continental U.S. (800) 253-1301
 Michigan (800) 632-2243
 Alaska & Hawaii (800) 253-1121

and talk with one of our trained Consultants. The Consultant can instruct you in how to obtain satisfactory operation from your appliance or, if service is necessary, recommend a qualified service company in your area.



3. If you need service * ...



Whirlpool has a nationwide network of franchised TECH-CARE[®] Service Companies. TECH-CARE service technicians are trained to fulfill the product warranty and provide after-

warranty service, anywhere in the United States. To locate TECH-CARE service in your area, call our COOL-LINE service assistance telephone number (see Step 2) or look in your telephone directory Yellow Pages under:

APPLIANCES—HOUSEHOLD—
MAJOR—SERVICE & REPAIR

WHIRLPOOL APPLIANCES
FRANCHISED TECH-CARE SERVICE

SERVICE COMPANIES
XYZ SERVICE CO
123 Maple 999-9999

ELECTRICAL APPLIANCES—
MAJOR—REPAIRING & PARTS

WHIRLPOOL APPLIANCES
FRANCHISED TECH-CARE SERVICE

SERVICE COMPANIES
XYZ SERVICE CO
123 Maple 999-9999

OR

WASHING MACHINES, DRYERS
& IRONERS—SERVICING

WHIRLPOOL APPLIANCES
FRANCHISED TECH-CARE SERVICE

SERVICE COMPANIES
XYZ SERVICE CO
123 Maple 999-9999

4. If you have a problem * ...

Call our COOL-LINE service assistance telephone number (see Step 2) and talk with one of our Consultants, or if you prefer, write to:

Mr. Guy Turner, Vice President
 Whirlpool Corporation
 Administrative Center
 2000 US-33 North
 Benton Harbor, MI 49022

If you must call or write, please provide: model number, serial number, date of purchase, and a complete description of the problem. This information is needed in order to better respond to your request for assistance.

*THIS PAGE
INTENTIONALLY LEFT
BLANK*



FSP is a registered trademark of Whirlpool Corporation for quality parts. Look for this symbol of quality whenever you need a replacement part for your Whirlpool appliance.

FSP replacement parts will fit right and work right, because they are made to the same exacting specifications used to build every new Whirlpool appliance.



Benton Harbor, Michigan. Automatic Washers, Clothes Dryers, Freezers, Refrigerator-Freezers, Ice Makers, Dishwashers, Built-in Ovens and Surface Units, Ranges, Microwave Ovens, Compactors, Room Air Conditioners, Dehumidifiers, Central Heating and Air Conditioning Systems.