

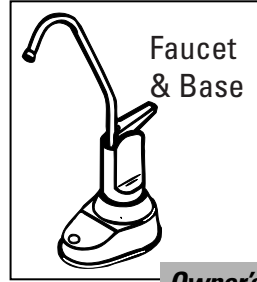

GE Appliances

Water Filtration System

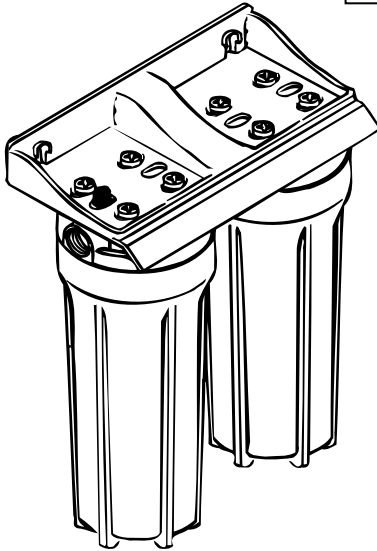

Owner's Manual

GXEM01Z01



GE Answer Center® 800.626.2000

Congratulations! ***You Are Now Part of the GE Family.***

Welcome to the GE family. We're proud of our quality products and we are committed to providing dependable service. You'll see it in this easy-to-use Owner's Manual and you'll hear it in the friendly voices of our customer service department.

Best of all, you'll experience these values each time you use the water system. That's important, because your system will be part of your family for many years. And we hope you will be part of ours for a long time to come.

We thank you for buying GE. We appreciate your purchase, and hope you will continue to rely on us whenever you need quality appliances for your home.

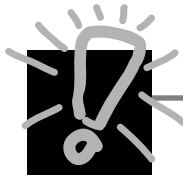

Important!

Staple sales slip or cancelled check here.

Proof of the original purchase date is needed to obtain service under the warranty.



Write the model and serial numbers here.

You can find them on the sump bracket.

GE & You, A Service Partnership.

Ask any GE appliance owner and they will tell you we stand behind our products with unmatched quality service. However, did you know that most questions result from simple problems that you can easily fix yourself in just a few minutes? This Owner's Manual can tell you how.



Read this Manual

Inside you will find many helpful hints on how to use and maintain your water system properly. Just a little preventive care on your part can save you a great deal of time and money over the life of your system.



Review the Section on Troubleshooting Tips

You'll find many answers to common problems here. If you review our chart of Troubleshooting Tips first, you may not need to call for service at all.

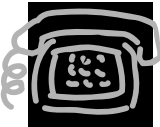

If You Need Service

If you do need service, you can relax knowing help is only a phone call away. A list of toll-free customer service numbers is included in the back section. Or you can always call the GE Answer Center® at 800.626.2000, 24 hours a day, 7 days a week.

Safety Information 4

Specification Guidelines 5

Safety Information

Operating Instructions

Using the System 6

Filter Cartridge Installation or Replacement 8

Operating Instructions

Troubleshooting Tips

Before You Call For Service 10

Troubleshooting Tips

Customer Service

Warranty Information 15
Service Telephone Numbers Back Cover

Customer Service

IMPORTANT SAFETY INFORMATION. READ ALL INSTRUCTIONS BEFORE USING.

▲ WARNING!

For your safety, the information in this manual must be followed to minimize the risk of property damage or personal injury.



SAFETY PRECAUTIONS

- Check with your local public works department for plumbing codes. You must follow these guidelines as you install the water filtration system.
 - Use the water filtration system on a potable, safe-to-drink, home **COLD** water supply only. The filter cartridges will not purify the water, or make it safe to drink.
 - **Do not** use on a hot water supply (100°F. max.).
- ▲ WARNING:** *Do not* use with water that is microbiologically unsafe, or of unknown quality, without adequate disinfection before or after the system, such as single-user wells, or other non-public water systems not regulated by federal or state health and safety requirements.



PROPER INSTALLATION

This water filtration system must be properly installed and located in accordance with the Installation Instructions before it is used. If you did not receive Installation Instructions, you can receive one by calling us toll-free at the GE Answer Center® 800.626.2000.

- Install or store where it will not be exposed to temperatures below freezing or exposed to any type of weather. Water freezing in the system will break it. Do not attempt to treat water over 100°F.
 - Your water filtration system will withstand up to 125 pounds per square inch (psi) water pressure. If your house water supply pressure is higher than 100 psi, install a pressure reducing valve before installing the water filtration system.
- ▲ WARNING:** Discard all unused and packaging material after installation.

SPECIFICATION GUIDELINES.

About the Water Filtration System

Many bad tastes and/or odors are removed from water using activated carbon filter cartridges. They are most often used to remove a chlorine taste and smell. They can also reduce other undesirable elements from drinking water supplies, such as organic chemical contaminants and lead.

NOTE: Small amounts of hydrogen sulfide (noticeable as “rotten egg” odor) may be reduced by taste and odor filters for a short time, but the carbon media is quickly exhausted. Other water conditioning equipment is usually required for the continuous treatment of hydrogen sulfide.

The GE water filtration system uses two filter cartridges.

Filter I

FXUS—a sediment/taste and odor filter cartridge:

- Reduces unpleasant tastes, odors, dirt, rust and sediments
- Reduces 95% chlorine for 1500 gallons of water
- 20 micron, activated carbon

Filter II (Options)

1 ***FXUT—a deluxe taste and odor filter cartridge***

- Reduces unpleasant tastes and odors
- Reduces 99% chlorine for 3000 gallons of water
- 20 micron, granular activated carbon

2 ***FXUV—an organic chemical contaminants filter cartridge***

- Reduces certain organic chemical contaminants like pesticides and herbicides
- Reduces 95% chemical contaminant for 500 gallons of water
- Reduces 99% chlorine for 500 gallons of water
- 20 micron, granular activated carbon

3 ***FXUL—a lead filter cartridge***

- Reduces 90% lead for 1000 gallons of water
- Reduces 99% chlorine for 1000 gallons of water
- 10–20 micron, carbon block

Maximum Supply Water Pressure — 125 pounds per square inch (psi)

Minimum - Maximum Supply Water Temperature — 40–100°F.

Inlet - Outlet — 3/8" NPT, fittings and tubing included

Maximum Filtered Water Flow — 0.6 gpm

Depending on the treatment needed for a specific water supply, the water filtration system can be customized using any combination of the preceding filter cartridges.

About the water filtration system.

Using the water filtration system and about the filter cartridge

The countertop faucet dispenses the filtered drinking water when opened. It has a hand operated, spring loaded closed lever to prevent waste. You can keep the faucet open by pushing upward on the lever to lock it against the faucet spout.

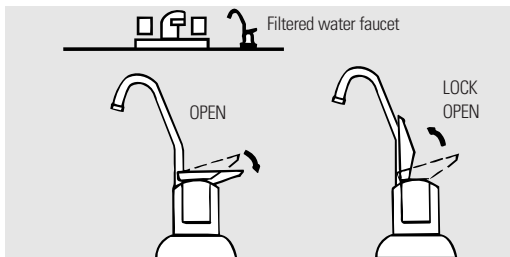

Filter Cartridge Life—Several variables determine how long the cartridges will last in your water filter system. These include:

- 1 **How much water you use.**
- 2 **How much sediment, taste and/or odor, lead, or other unwanted substance, is in the water.**

No matter which water filter system you have, you should replace the cartridges every six months, when indicated by the electronic indicator light on the base. In extremely poor water supplies, you may notice the return of the unwanted substance in your water before the six months. In this case the cartridges should be replaced immediately. If the system is also for lead or chemical contaminant removal, it is **MORE IMPORTANT** to replace the cartridges at least every six months.

NOTE: If the water supply contains high amounts of sediments, the carbon filters may plug with them, reducing filtered water flow to the system faucet. *Cartridge replacement is needed to restore flow.*

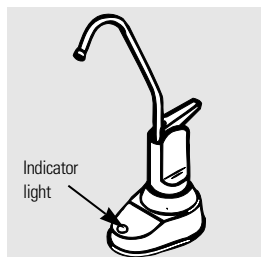

Electronic Indicator Light—The electronic indicator light on the base of the faucet is a six month timer that shows you when to replace the filter cartridges. When the battery pack is first installed, the indicator light will light briefly to show that the electronics are operating. If this does not happen, the batteries could be installed backwards or the leadwires are not connected.

After about six months, the indicator light begins to flash. It is time to replace the filter cartridges. When replacing the filter cartridges, also replace the batteries in the battery pack. Two “AA” batteries are required.

About the water filtration system.

Filter Cartridge Installation or Replacement

▲ CAUTION: Never remove the sumps when water pressure is in the water filtration system.

- 1 Close the water supply saddle valve to the filter. (See the Installation Instructions for saddle valve location.) Press the vent valve on the top of the filter I head to relieve the pressure in the system, or open the filtered water faucet.
- 2 Remove the sump, using the sump wrench tool provided, from the filter head, by rotating the sump as shown in the below illustration. Be careful, the sump may be full of water. Be sure to keep the large o-ring seal.

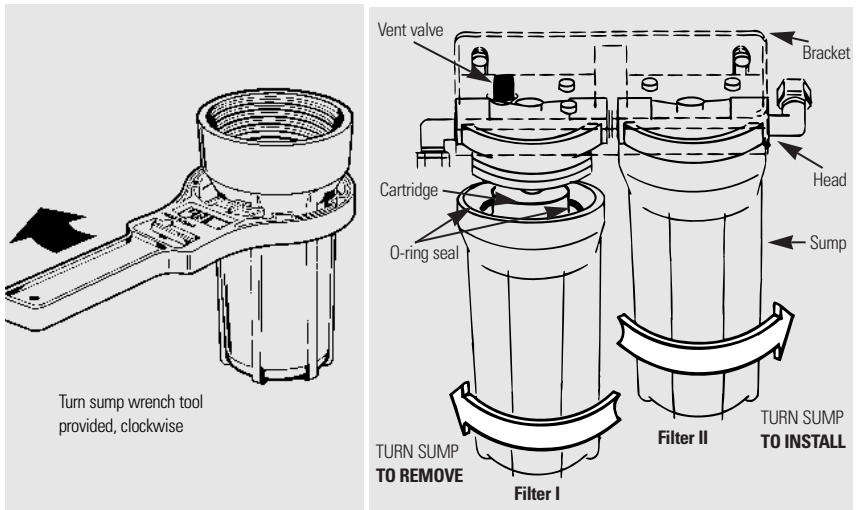

- 3 If you are replacing a filter cartridge, remove and discard the used filter cartridge.
- 4 Be sure the inside of the sump is clean. Thoroughly wash the inside of the sump with hot, soapy water and rinse.
- 5 Remove the wrapper from the new filter cartridge and insert the filter cartridge in the sump. Some cartridges fit either way, while others fit only one way. Observe markings on the cartridge.

NOTE: The water filtration system uses two different types of filter cartridges. Be sure to install them correctly.

The sediment/taste and odor filter (FXUS) should always be placed in the filter I sump.

- 6 Lightly lubricate the o-ring seal in the sump with clean silicone grease. Be sure it is fully seated in its groove.
- 7 Hold the sump up to the filter head, aligning the center hole in the cartridge with the protrusion on the bottom of the head.
- 8 Being careful not to cross-thread, rotate the sump onto the filter head and tighten securely using the sump wrench tool provided.

NOTE: If the sump will not tighten up to the head, you may have the cartridge in upside down. Take the cartridge out and check for correct orientation.

- 9 **Repeat steps 2 through 8 for filter II.**
- 10 Turn on the filtered water faucet. Then, slowly open the water supply saddle valve and allow the filter housing to fill. While it is filling, press the filter vent valve to release air in the filter.
- 11 Close the filtered water faucet. Then check for leaks between the sump and the head.

NOTE: If leaking, turn off the water supply and turn on the filtered water faucet, or press the vent valve to depressurize the filter. Disassemble the filter and check the o-ring for cuts, flat spots, etc., and sealing surfaces for foreign material. Clean the o-ring and lightly lubricate with clean silicone grease. Carefully press into the groove in the sump.

- 12 If you are replacing the batteries, remove, properly discard and install two new “AA” alkaline batteries in the battery pack. Removing the batteries, or momentarily disconnecting the leadwires, resets the six month electronic timer.
- 13 The filter cartridges contain activated carbon, a black powder. When new, turn on the filtered water faucet and allow the fine, harmless carbon particles to purge from the cartridge. Turn off the faucet when you no longer see the particles in the filtered water.

About the water filtration system.

Flush Procedure

Whenever water of unknown quality is passed through the GE Water Filtration System, filter elements should be discarded and the filtration system flushed.

Circumstances that may require flushing the system are:

- Boil-Water Advisory.
- Flooding of the GE Water Filtration System.
- Long-term non-use.

The procedure for flushing the GE Water Filtration System is:

- See *Filter Cartridge Installation or Replacement* section on page 8 and follow steps 1, 2, 3, and 4.
- Next, reinstall the sumps (without the filter elements), turn water on, and flush water through the faucet for one minute.
- Then, turn water off, remove sumps, empty water out of sumps and install new filter elements.

Follow steps 6–9 on page 9, *Filter Cartridge Installation or Replacement* section, to complete.

Before you call for service...



Troubleshooting Tips

Review the charts on the following pages first and you may not need to call for service.

Problem	Possible Causes	What To Do
Water contains tiny black particles	New filter cartridges contain activated carbon, which is a harmless black powder	<ul style="list-style-type: none"> • Turn on the filtered water faucet and allow these harmless carbon particles to purge from the cartridge. Turn off the faucet when the water is clear.
Water has air bubbles and is cloudy	Air in system after installation	<ul style="list-style-type: none"> • Will go away after water runs for a while.
Indicator light on the faucet base is flashing	Six months usage has occurred. This is the maximum life of the filter cartridges	<ul style="list-style-type: none"> • Replace both filters and batteries in the battery pack.
Indicator light on the faucet base is not working	Faucet base leadwire not connected to battery pack leadwire	<ul style="list-style-type: none"> • Connect.
	Batteries may need to be replaced or they may have been installed incorrectly	<ul style="list-style-type: none"> • Observe orientation markings on the holder and install correctly. Replace batteries if old.
	Leadwires damaged	<ul style="list-style-type: none"> • Inspect and repair as needed.
Chlorine taste and/or odor in the product water	The filter cartridges no longer removing chlorine from the water supply	<ul style="list-style-type: none"> • Replace both cartridges and batteries in the battery pack.

Customer Service

Troubleshooting Tips

Operating Instructions

Safety Information

Notes



GE Appliances

**Consumer Product
Ownership Registration
Important Mail Today**

Place in an envelope and mail to:

General Electric Company
Warranty Registration Department
P.O. Box 34070
Louisville, KY 40232-4070

Consumer Product Ownership Registration

Dear Customer:

Thank you for purchasing our product and thank you for placing your confidence in us. We are proud to have you as a customer!

Follow these three steps to protect your new appliance investment:

1 Complete and mail your Consumer Product Ownership Registration today. Have the peace of mind of knowing we can contact you in the unlikely event of a safety modification.

2 After mailing the registration below, store this document in a safe place. It contains information you will need should you require service. Our service number is 800-GE-CARES. (800-432-2737).

3 Read your "Owner's Manual" carefully. It will help you operate your new appliance properly. If you have questions, or need more information call the GE Answer Center® 800.626.2000.

Product

Model

Serial

WATER TREATMENT |

Important: If you did not get a registration card with your product, detach and return the card below to ensure that your product is registered.



Consumer Product Ownership Registration

Product

Model

Serial

WATER TREATMENT |

Mr. Ms. Mrs. Miss

First Name |

Last Name |

Street Address |

Apt. # |

City |

State |

Zip Code |

Date Placed In Use Month |

Day |

Year |

Phone Number |

- |

- |

**Important
Mail
Today!**



GE Appliances

General Electric Company
Louisville, Kentucky 40225

GE Water Filtration System Warranty



All warranty service provided by our SmartWater™ Authorized Servicer Network. For service, call 800-GE-CARES.

For The Period Of:

One Year

From the date of the original purchase

GE Will Replace:

Any part of the Water Filtration System (excluding filters) which fails due to a defect in materials or workmanship. During this **limited one-year warranty**, GE will also provide, **free of charge**, all labor (does not include service trip to home) to replace the defective part.

What GE Will Not Cover:

- Service trips to your home to teach you how to use the product.
- Improper installation.
- Failure of the product if it is abused, misused, or used for other than the intended purpose or used commercially.
- Use of this product where water is microbiologically unsafe or of unknown quality without adequate disinfection before or after the system, such as single-user wells, or other non-public water systems not regulated by federal or state health and safety requirements.
- Filter cartridges, membranes or batteries.
- Replacement of house fuses or resetting of circuit breakers.
- Damage to the product caused by accident, fire, floods or acts of God.
- Incidental or consequential damage to personal property caused by possible defects with this appliance.

This warranty is extended to the original purchaser and any succeeding owner for products purchased for home use within the USA. In Alaska, the warranty excludes the cost of shipping or service calls to your home.

Some states do not allow the exclusion or limitation of incidental or consequential damages. This warranty gives you specific legal rights, and you may also have other rights which vary from state to state. To know what your legal rights are, consult your local or state consumer affairs office or your state's Attorney General.

Service Telephone Numbers.



GE Answer Center® 800.626.2000

The GE Answer Center® is open 24 hours a day, 7 days a week.



In-Home Repair Service 800-GE-CARES (800-432-2737)

Expert GE repair service is only a phone call away.



Special Needs Service 800.626.2000

TDD 800-TDD-GEAC (800-833-4322)

GE offers, free of charge, Braille controls for a variety of GE appliances and a brochure to assist in planning a barrier-free kitchen for persons with limited mobility.



Service Contracts 800-626-2224

Purchase a GE service contract while your warranty is still in effect and you'll receive a substantial discount. GE Consumer Service will still be there after your warranty expires.

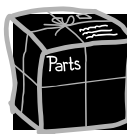

Parts and Accessories 800-626-2002

Individuals qualified to service their own appliances can have parts or accessories sent directly to their homes (VISA, MasterCard and Discover cards are accepted).

Instructions contained in this manual cover procedures to be performed by any user. Other servicing generally should be referred to qualified service personnel. Caution must be exercised, since improper servicing may cause unsafe operation.



Service Satisfaction

If you are not satisfied with the service you receive from GE, follow these steps. **First**, contact the people who serviced your appliance. If you are still not pleased, write all the details—including your phone number—to: Manager, Consumer Relations, GE Appliances, Appliance Park, Louisville, KY 40225.