

# Use & Care Guide

## Electric Cooktop

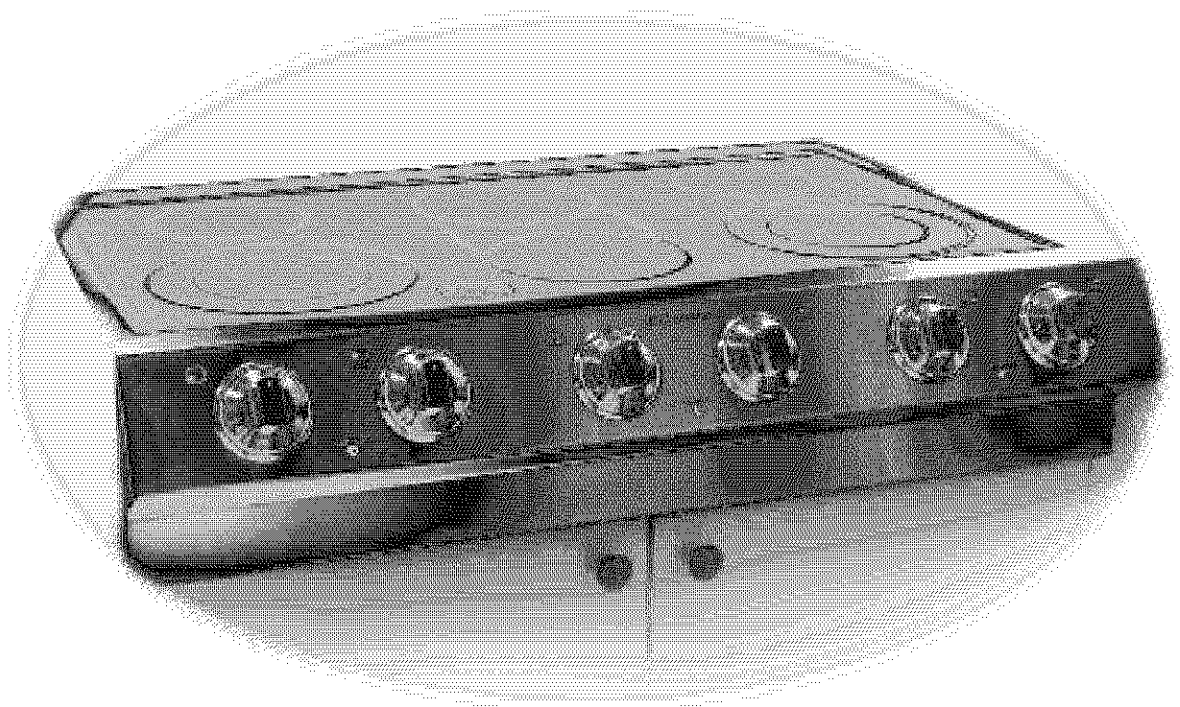

 **Electrolux**

# Finding Information

## MAKE A RECORD FOR FUTURE USE

Brand \_\_\_\_\_

Purchase Date \_\_\_\_\_

Model Number \_\_\_\_\_

Serial Number \_\_\_\_\_

### NOTE

The serial and model numbers are available on the serial plate located under the cooktop.

## QUESTIONS?

For toll-free telephone support in the U.S. and Canada:  
**1-877-4ELECTROLUX (1-877-435-3287)**

For online support and internet product information:  
**[www.electrolux.com](http://www.electrolux.com)**

## TABLE OF CONTENTS

<b>Finding Information</b> .....	<b>2</b>	<b>Solutions to Common Problems</b> .....	<b>16</b>
Make a Record for Future use .....	2	Entire Cooktop Does Not Operate .....	16
Questions? .....	2	Surface Element Does Not Heat .....	16
<b>Safety</b> .....	<b>4</b>	Surface Element Too Hot or Not Hot Enough ...	16
Important Safety Instructions .....	4	Food Not Heating Evenly .....	17
<b>Setting Surface Controls</b> .....	<b>7</b>	Scratches or Abrasions on Ceramic	
About the Ceramic Glass Cooktop .....	7	Glass Cooktop Surface .....	17
About the Radiant Surface Elements .....	7	Metal Marks on Ceramic Glass	
Locations of the Radiant Surface Elements .....	8	Cooktop Surface .....	17
Surface Cooking Settings .....	8	Brown Streaks and Specks on Ceramic Glass	
Operating the Single Surface Radiant Elements .	9	Cooktop Surface .....	17
Operating the Dual Surface Radiant Elements ..	10	Areas of Discoloration on Ceramic	
Operating the Bridge Surface Radiant Element .	11	Glass Cooktop Surface .....	18
Hot Surface Indicator Lights .....	11	<b>Notes</b> .....	<b>19</b>
Surface Cooking utensils .....	12	<b>Warranty Information</b> .....	<b>20</b>
Using the Griddle .....	12		
<b>General Care &amp; Cleaning</b> .....	<b>13</b>		
Care & Cleaning Table .....	13		
Cooktop Cleaning and Maintenance .....	14		
Cleaning Recommendations for the			
Ceramic Glass Cooktop .....	14-15		
Care & Cleaning of Stainless Steel .....	15		

## IMPORTANT SAFETY INSTRUCTIONS

Please read all safety instructions before using your new Electrolux cooktop.

### **⚠ WARNING**

To reduce the risk of fire, electrical shock, or injury when using your electric cooktop, follow basic precaution including the following:

- **Remove all tape and packaging wrap before using the appliance. Destroy the carton and plastic bags after unpacking the appliance.** Never allow children to play with packaging material.
- **Proper Installation.** Be sure your appliance is properly installed and grounded by a qualified technician in accordance with the National Electrical Code No. 70 - latest edition in the United States, or CSA C22.1, Part 1 in Canada, and local code requirements. Install only per installation instructions provided in the literature package for this appliance.

Ask your dealer to recommend a qualified technician and an authorized repair service. Know how to disconnect the electrical power to the appliance at the circuit breaker or fuse box in case of an emergency.

- **User Servicing.** Do not repair or replace any part of the appliance unless specifically recommended in the manuals. All other servicing should be done only by a qualified technician to reduce the risk of personal injury and damage to the appliance.
- **Never modify or alter the construction of an appliance such as removal of panels, wire covers or any other permanent part of the appliance.**
- **Storage on Appliance.** Flammable materials should not be stored near surface units. This includes paper, plastic and cloth items, such as cookbooks, plasticware and towels, as well as flammable liquids. Do not store explosives, such as aerosol cans, on or near the appliance. Flammable materials may explode and result in fire or property damage.

### **⚠ CAUTION**

Do not store items of interest to children in the cabinets above the appliance. Children climbing on the cooktop to reach items could be seriously injured.

- **Do not leave children alone.** Children should not be left alone or unattended in the area where an appliance is in use. They should never be allowed to sit or stand on any part of the appliance.

- **DO NOT TOUCH SURFACE UNITS OR AREAS NEAR THESE UNITS.** Surface units may be hot even though they are dark in color. Areas near surface units may become hot enough to cause burns. During and after use, do not touch, or let clothing or other flammable materials touch these areas until they have had sufficient time to cool. Among these areas are the cooktop and areas facing the cooktop.
- **Wear Proper Apparel.** Loose-fitting or hanging garments should never be worn while using the appliance. Do not let clothing or other flammable materials contact hot surfaces.

## A WARNING

Never use your appliance for warming or heating the room.

- **Do Not Use Water or Flour on Grease Fires.** Smother the fire with a pan lid, or use baking soda, a dry chemical or foam-type extinguisher.
- **When heating fat or grease, watch it closely.** Fat or grease may catch fire if allowed to become too hot.
- **Use Only Dry Pot holders.** Moist or damp pot holders on hot surfaces may result in burns from steam. Do not let the pot holders touch hot surface units. Do not use a towel or other bulky cloth instead of a pot holder.
- **Do Not Heat Unopened Food Containers.** Buildup of pressure may cause the container to burst and result in injury.

**IMPORTANT.** Do not attempt to operate the cooktop during a power failure. If the power fails, always turn off the cooktop. If the cooktop is not turned off and the power resumes, the cooktop will begin to operate again. Food left unattended could catch fire or spoil.

## IMPORTANT SAFETY INSTRUCTIONS FOR USING YOUR COOKTOP

- **Know which knob controls each surface unit.**
- **Clean the appliance regularly to keep all parts free of grease that could catch fire.** Exhaust fan ventilation hoods and grease filters should be kept clean. Do not allow grease to accumulate on hood or filter. Greasy deposits in the fan could catch fire. When flaming food under the hood, turn fan on. Refer to hood manufacturer's instructions for cleaning.
- **Use Proper Pan Size.** This appliance is equipped with one or more surface units of different sizes. Select utensils having flat bottoms large enough to cover the surface unit. The use of undersized utensils will expose a portion of the surface heating unit to direct contact and may result in ignition of clothing. Proper relationship of utensil to element will also improve efficiency.

- **Utensil Handles Should Be Turned Inward and Not Extend Over Adjacent Surface Units.** To reduce the risk of burns, ignition of flammable materials, and spillage due to unintentional contact with the utensil.
- **Never Leave Surface Units Unattended.** Boilovers cause smoking and greasy spillovers that may ignite, or a pan that has boiled dry may melt.
- **Protective Liners.** Do not use aluminum foil to line any part of the appliance. Only use aluminum foil as recommended for baking if used as a cover placed on the food. Any other use of protective liners or aluminum foil may result in a risk of electric shock or fire or short circuit.
- **Glazed Cooking Utensils.** Only certain types of glass, glass/ceramic, ceramic, earthenware, or other glazed utensils are suitable for range top service without breaking due to the sudden change in temperature. Check the manufacturer's recommendations for cooktop use.
- **Do Not Use Decorative Surface Element Covers.** If an element is accidentally turned on, the decorative cover will become hot and possibly melt. Burns will occur if the hot covers are touched. Damage may also be done to the appliance.
- **Ventilating hood.** The ventilating hood above your cooking surface should be cleaned frequently, so the grease from cooking vapors does not accumulate on the hood or filter.

## FOR CERAMIC-GLASS COOKTOP ONLY

- **Do Not Clean or Operate a Broken Cooktop.** If cooktop should break, cleaning solutions and spillovers may penetrate the broken cooktop and create a risk of electric shock. Contact a qualified technician immediately.
- **Clean Cooktop with Caution.** If a wet sponge or cloth is used to wipe spills on a hot cooking area, be careful to avoid a steam burn. Some cleaners can produce harmful fumes if applied to a hot surface.
- **Do Not Place Hot Cookware on Cold Cooktop Glass.** This could cause glass to break.
- **Do not slide pan across the cooktop surface.** They may scratch the cooktop surface.
- **Do Not Let Pans Boil Dry.** This may cause permanent damage in the form of breakage, fusion, or marking that can affect the ceramic-glass cooktop. (This type of damage is not covered by your warranty).

## IMPORTANT SAFETY NOTICE

The California Safe Drinking Water and Toxic Enforcement Act requires the Governor of California to publish a list of substances known to the state to cause cancer, birth defects or other reproductive harm, and requires businesses to warn customers of potential exposure to such substances.

## NOTE

Save these important safety instructions for future reference.

## ABOUT THE CERAMIC GLASS COOKTOP

The ceramic cooktop has radiant surface elements located below the surface of the glass. The design of the ceramic cooktop outlines the area of the surface element underneath. **Make sure** the diameter of the pan matches the diameter of the element outline on the cooktop (See Figure).

Heat is transferred up through the surface of the cooktop to the cookware. Only flat-bottom cookware should be used. The type and size of cookware, the number of surface elements in use and their settings, are all factors that will affect the amount of heat that will spread to areas beyond the surface elements. The areas surrounding the elements may become **hot enough to cause burns**.

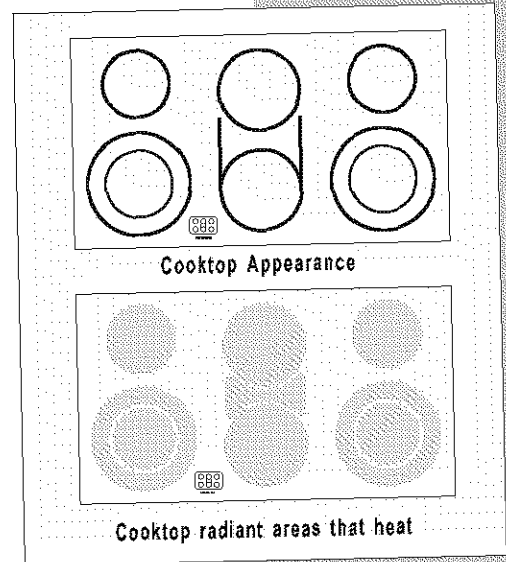

## ABOUT THE RADIANT SURFACE ELEMENTS

The element temperature rises gradually and evenly. As the temperature rises, the element will glow red. To maintain the selected setting, the element will cycle on and off. The heating element retains enough heat to provide a uniform and consistent heat during the off cycle. For efficient cooking, turn off the element several minutes before cooking is complete. This will allow residual heat to complete the cooking process.

### NOTE

Radiant elements have a limiter that allows the element to cycle on and off, even at the HI setting. This helps to prevent damage to the ceramic glass cooktop. Cycling at the HI setting is normal and can also occur if the cookware is too small for the radiant element or if the cookware bottom is not flat (Refer to page 12 for using correct cookware instructions with the cooktop).

Please read detailed instructions for ceramic glass cooktop cleaning in the General Care & Cleaning section and **Solutions to Common Problems** section of this Use and Care Guide.

# Setting Surface Controls

## LOCATIONS OF THE SURFACE RADIANT ELEMENTS

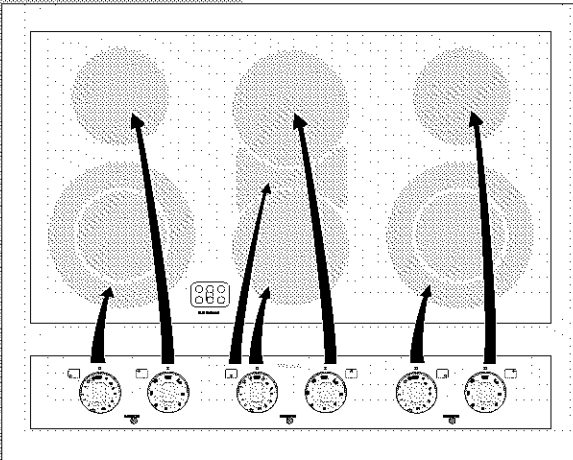

Your appliance is equipped with radiant surface burners with 4 different wattage ratings. The ability to heat food quicker and in larger volumes increases as the element wattage increases.

The radiant surface elements are located on the cooktop as follows (See Figure):

- 2 smaller **6 inch** radiant elements located at the right and left rear positions;
- 2 dual **6 or 9 inch** radiant elements located at the right and left front positions;
- 2 **7 inch** radiant elements located at both the center front and rear position;
- one **Bridge** radiant element located between center front and rear elements.

## SURFACE COOKING SETTINGS

Use the chart to determine the correct setting for the kind of food you are preparing. The Simmer settings are used to simmer and keep larger quantities of foods warm such as stews and soups. The lower Simmer settings are ideal for delicate foods and melting chocolate or butter.

**Note:** The size and type of cookware used will influence the setting needed for best cooking results.

Recommended Settings for Surface Elements	
Setting	Type of Cooking
HIGH (HI)	Start most foods, bring water to a boil, pan broiling
MEDIUM HIGH (8-10)	Continue a rapid boil, fry, deep fat fry
MEDIUM (6)	Maintain a slow boil, thicken sauces and gravies, steam vegetables
MEDIUM LOW (2 - 4)	Keep foods cooking, poach, stew
LOW (LO)	Keep warm, melt, simmer



# OPERATING THE SINGLE SURFACE RADIANT ELEMENTS

The cooktop has single radiant surface elements at 3 locations; the right, center and left rear (Figure 1) element positions.

## To Operate the Single Surface Element

1. Place correctly sized cookware on the radiant surface element.
2. Push in and turn the surface control knob in either direction to the desired setting (Figure 2). Turn the knob to adjust the setting if desired. Start most cooking operations on a higher setting and then turn to a lower setting to finish cooking. Each surface element provides a constant amount of heat at each setting. A glowing red surface indicates the cookware is **too small** for the surface heating area.
3. When cooking has completed, turn the surface control knob to OFF before removing the cookware. **Note:** The Hot Surface Indicator light will come on when the control knob is turned on and will continue to glow until the glass cooktop has cooled down to a moderate level. The light may remain on even though the controls are turned OFF.

### NOTE

See page 8 for recommended control settings.

### A CAUTION

Radiant surface elements may appear to have cooled after they have been turned off. A hot surface indicator light will come on and will continue to glow until the glass cooktop has cooled down to a moderate level. The glass surface may still be hot and burns may occur if the glass surface is touched before the indicator light has turned off.

Do not place plastic items such as salt and pepper shakers, spoon holders or plastic wrappings on top of the range when it is in use. These items could melt or ignite. Potholders, towels or wooden spoons could catch fire if placed too close to the surface elements.

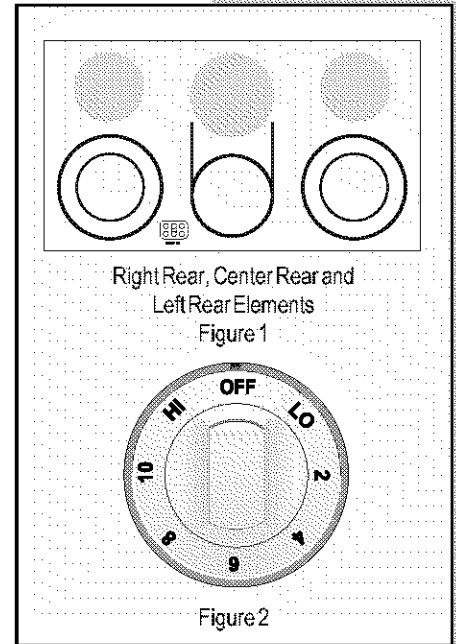

Right Rear, Center Rear and  
Left Rear Elements

Figure 1

Figure 2

# Setting Surface Controls

## OPERATING THE DUAL SURFACE RADIANT ELEMENTS

The cooktop is equipped with dual radiant surface element located at the right & left front (See Figure 1 or 3) positions. Symbols on the knob are used to indicate which coil of the dual radiant element will heat. The ● symbol indicates that only the inner coil will heat (Figure 1). The ⊙ symbol indicates that both inner and outer coils will heat (Figure 3). You may switch from either coil setting at any time during cooking.

### To Operate the Dual Surface Element:

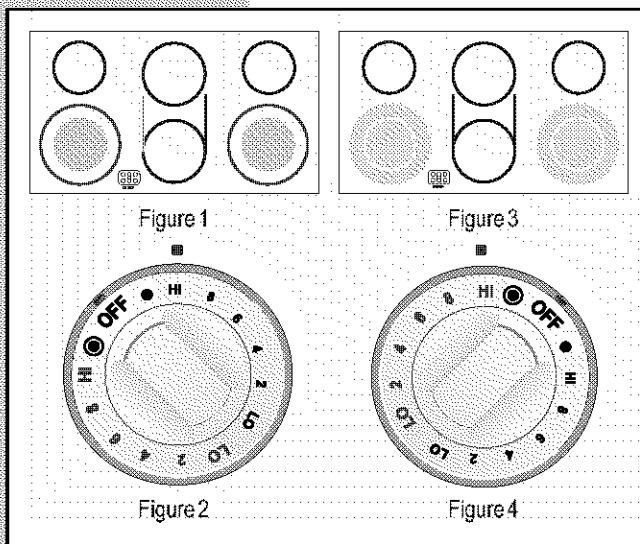

1. Place correctly sized cookware on the dual surface element.
2. Push in and turn the control knob counterclockwise (See Figure 2) for smaller cookware or clockwise (See Figure 4) for larger cookware.
3. Turn the knob to adjust the setting if needed. Start most cooking operations on a higher setting and then turn to a lower setting to finish cooking. Each surface element provides a constant amount of heat at each setting. A glowing red surface heating area extending beyond the bottom edge of the cookware indicates the cookware is **too small** for the surface heating area.
4. When cooking has completed, turn the surface control knob to OFF before removing the cookware. **Note:** The Surface Indicator light will come on when the control knob is turned on and will continue to glow until the glass cooktop has cooled down to a moderate level. The light may remain on even though the controls are turned OFF.

### NOTE

See page 8 for recommended control settings.



### CAUTION

Radiant surface elements may appear to have cooled after they have been turned off. A hot surface indicator light will come on and will continue to glow until the glass cooktop has cooled down to a moderate level. The glass surface may still be hot and burns may occur if the glass surface is touched before the indicator light has turned off.

Do not place plastic items such as salt and pepper shakers, spoon holders or plastic wrappings on top of the range when it is in use. These items could melt or ignite. Potholders, towels or wooden spoons could catch fire if placed too close to the surface elements.

## OPERATING THE BRIDGE SURFACE RADIANT ELEMENT

The cooktop is equipped with a "Bridge" surface element located at the center front and middle positions. The Bridge can be used when cooking with rectangular (like a griddle) or oval shaped cookware. The element will maintain an even temperature setting across both portions of the Bridge. If needed for normal cookware, the Bridge element can work like a single element without the Bridge.

Bridge element operation symbols are located on the Bridge element control knob. These symbols indicate the direction to turn the control knob when operating the Bridge element. The symbol  indicates that only the single portion of the Bridge element will heat (see Figures 1 and 2). The symbol  indicates that both the single and Bridge portions of the element will heat together (see Figures 3 and 4). You may switch from either of these settings at any time during cooking with the Bridge element.

### To Operate the Bridge Surface Element:

1. Place correctly sized cookware on the dual surface element.
2. Push in and turn the control knob counterclockwise (see Figure 2) to heat the portion of the Bridge element for normal shaped cookware or clockwise (see Figure 4) for larger or rectangular shaped cookware.
3. Turn the knob to adjust the setting if needed. Start most cooking operations on a higher setting and then turn to a lower setting to finish cooking. Each surface element provides a constant amount of heat at each setting. A glowing red surface heating area extending beyond the bottom edge of the cookware indicates the cookware is **too small**. Please note that not all cookware will fit the Bridge element correctly.
4. When cooking has completed, turn the surface control knob to OFF before removing the cookware. **Note:** The Surface Indicator light will come on when the control knob is turned on and will continue to glow until the glass cooktop has cooled down to a moderate level. The light may remain on even though the controls are turned OFF.

The BRIDGE element may also be used in combination with the center rear single element (see Figure 5). Because these element have 2 different controls, one element can be used to cook while the other element may be used to keep food warm.

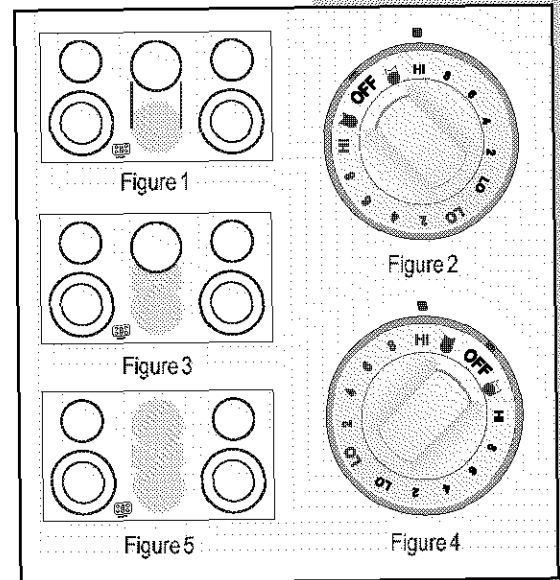

## HOT SURFACE INDICATOR LIGHTS

This model have indicator lights located on the ceramic glass cooktop that glows as soon as the glass begins to warm up. When heating units is turned off, it will continue to glow as long as the glass remains warm enough to cause burns.

## SURFACE COOKING UTENSILS

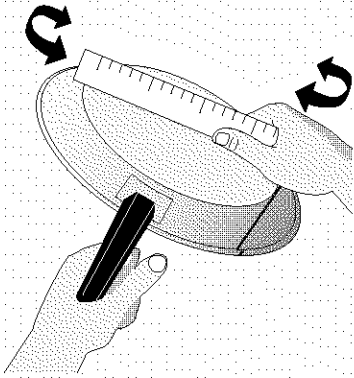

Cookware should have flat bottoms that make good contact with the entire surface heating element. Check for flatness by rotating a ruler across the bottom of cookware. Be sure to follow the recommendations for using cookware as shown in figure aside.

**Note:** Always use a utensil for its intended purpose. Follow manufacturer's instructions. Some utensils were not made to be used in the oven or on the cooktop.

\* Specialty pans such as lobster pots, griddles and pressure cookers may be used but must conform to the above recommended cookware requirements.

**Note:** The size and type of cookware used will influence the setting needed for best cooking results.

\*GOOD

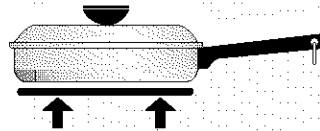

- Flat bottom and straight sides.
- Tight fitting lids.
- Weight of handle does not tilt pan. Pan is well balanced.
- Pan sizes match the amount of food to be prepared and the size of the surface element.
- Made of material that conducts heat well.
- Easy to clean.
- Always match pot diameter to element surface diameter.

POOR

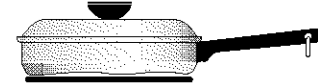

- Curved and warped pan bottoms.

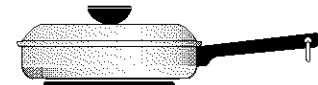

- Pan overhangs unit by more than 2.5 cm (1").

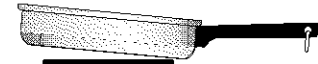

- Heavy handle tilts pan.

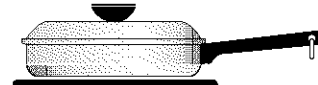

- Pan is smaller than element.

## USING THE GRIDDLE

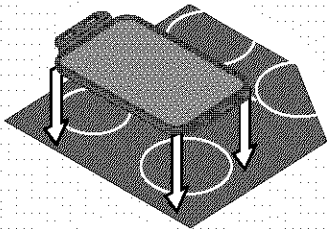

figure 1

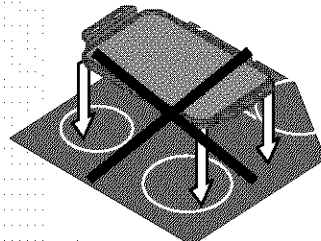

figure 2

The griddle is intended for direct food cooking. Do not use pans or other cookware on the griddle. Doing so could damage griddle finish. Set the griddle over the element (figure 1) taking care to not put the legs of the griddle directly on the heating area (figure 2).

### CAUTION

Always place the griddle on the cooktop before turning on the element.

Always use potholders to remove the griddle from the cooktop. Allow griddle to cool before removing. Do not set hot griddle on surfaces that cannot withstand high heat; such as countertops.

Be sure the griddle is positioned correctly and stable before use to prevent hot spills and possible burns.

## CARE & CLEANING TABLE

Surfaces	How to Clean
Aluminum & Vinyl	Use hot, soapy water and a cloth. Dry with a clean cloth.
Painted and Plastic Control Knobs	<i>For general cleaning, use hot, soapy water and a cloth. For more difficult soils and built-up grease, apply a liquid detergent directly onto the soil. Leave on soil for 30 to 60 minutes. Rinse with a damp cloth and dry. <b>DO NOT</b> use abrasive cleaners on any of these materials; they can scratch. To remove control knobs, turn to the OFF position; grasp firmly and pull straight off the shaft. To replace knobs after cleaning, line up the flat sides of both the knob and the shaft; then push the knob into place.</i>
Stainless Steel, Chrome Control Panel, Decorative Trim	Clean <b>stainless steel</b> with hot, soapy water and a dishcloth. Rinse with clean water and a cloth. <b>Do not use cleaners with high concentrations of chlorides or chlorines.</b> Do not use harsh scrubbing cleaners. Only use kitchen cleaners that are especially made for cleaning stainless steel. Always be sure to rinse the cleaners from the surface as bluish stains may occur during heating that cannot be removed.

# General Care & Cleaning

## COOKTOP CLEANING AND MAINTENANCE

Consistent and proper cleaning is essential to maintaining your ceramic glass cooktop

Prior to using your cooktop for the first time, apply the recommended Cleaning Creme to the ceramic surface. A sample of that cleaning creme is supplied with your appliance and it is available in store. Clean and buff with a paper towel. This will make cleaning easier when soiled from cooking. The special cooktop cleaning cream leaves a protective finish on the glass to help prevent scratches and abrasions.

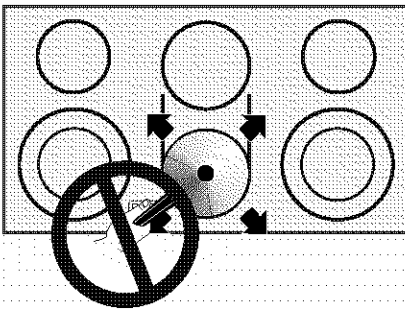

Sliding aluminum or copper clad bottom pans on the cooktop can cause metal markings on the cooktop surface. These marks should be removed **immediately** after the cooktop has cooled using the cooktop cleaning cream. Metal marks can become permanent if not removed prior to future use.

Cookware (cast iron, metal, ceramic or glass) with rough bottoms can mark or scratch the cooktop surface. **Do not slide anything metal or glass** across the cooktop. **Do not use your cooktop as a cutting board or work surface in the kitchen.** **Do not cook foods directly on the cooktop surface without a pan.** **Do not drop heavy or hard objects on the glass cooktop, they may cause it to crack.**

## CLEANING RECOMMENDATIONS FOR THE CERAMIC GLASS COOKTOP

### CAUTION

Before cleaning the cooktop, be sure the controls are turned to OFF and the cooktop is COOL.

### WARNING

**DO NOT** use a cooktop cleaner on a hot cooktop. The fumes can be hazardous to your health, and can chemically damage the ceramic-glass surface.

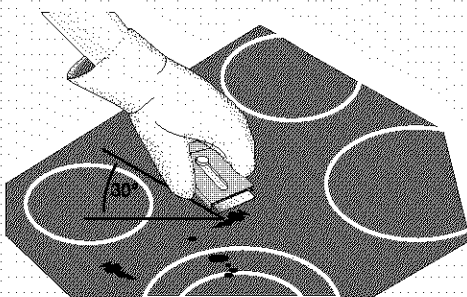

#### For light to moderate soil:

Apply a few drops of CookTop® Cleaning Creme directly to the cooktop. Use a paper towel to clean the entire cooktop surface. Make sure the cooktop is cleaned thoroughly, leaving no residue. Do not use the towel you use to clean the cooktop for any other purpose.

#### For heavy, burned on soil:

First, clean the surface as described above. Then, if soils remain, carefully scrape soils with a metal razor blade scraper, holding scraper at a 30 degree angle to the surface. Remove loosened soils with cooktop cleaning cream and buff surface clean.

## CLEANING RECOMMENDATIONS FOR THE CERAMIC GLASS COOKTOP (CONTINUED)

### A CAUTION

Damage to the ceramic glass cooktop may occur if you use scrub pad.

#### Plastic or foods with a high sugar content:

These types of soils need be removed immediately if spilled or melted onto the ceramic cooktop surface. Permanent damage (such as pitting of the cooktop surface) may occur if not removed **immediately**. After turning the surface elements OFF, use a razor blade scraper or a metal spatula with a mitt and scrape the soil from the hot surface (as illustrated on previous page). Allow the cooktop to cool, and use the same method for heavy or burned on soils.

#### Do not use the following on the ceramic glass cooktop:

- Do not use abrasive cleaners and scouring pads, such as metal and some nylon pads. They may scratch the cooktop, making it more difficult to clean.
- Do not use harsh cleaners, such as chlorine bleach, ammonia or oven cleaners, as they may etch or discolor the cooktop.
- Do not use dirty sponges, cloths or paper towels, as they can leave soil or lint on the cooktop which can burn and cause discoloration.



#### Special Caution for Aluminum Foil and Aluminum Cooking Utensils

- **Aluminum foil** - Use of aluminum foil will damage the cooktop. Do not use thin aluminum cooking utensils or allow foil to touch the ceramic cooktop under ANY circumstances.
- **Aluminum utensils** - The melting point of aluminum is much lower than that of other metals. Care must be taken when aluminum pots or pans are used on the cooktop. If allowed to boil dry, not only will the utensil be destroyed, but it may fuse to, break or mark the ceramic glass surface, permanently damaging the cooktop surface.

## CARE AND CLEANING OF STAINLESS STEEL

Special care and cleaning are **required** for maintaining the appearance of stainless parts. Please refer to the table provided at the beginning of the **General Care & Cleaning** section in this Use & Care Manual.

## IMPORTANT

Before calling for service, review this list. It may save you both time and expense. This list includes common experiences that are not the result of defective workmanship or material in your cooktop.

## ENTIRE COOKTOP DOES NOT OPERATE

- House fuse has blown or circuit breaker has tripped. Check/reset breaker or replace fuse. If the problem is a circuit overload, have this situation corrected by a qualified electrician.
- Service wiring not complete. Contact installation agent or dealer.
- Power outage. Check house lights to be sure. Call local electric company.

## SURFACE ELEMENT DOES NOT HEAT

- No power to appliance. Check/reset breaker or replace fuse. If the problem is a circuit overload, or improper connection of the armored cable supplied with the appliance, have this situation corrected by a qualified electrician.
- Too low heat setting. Turn control to a slightly higher setting until element comes on.
- Incorrect control is on. Be sure to use correct control for the element to be used.

## SURFACE ELEMENT TOO HOT OR NOT HOT ENOUGH

- Incorrect control setting. Raise or lower setting until proper amount of heat is obtained. Dial markings are an indicator of relative heat settings and will vary slightly.
- Lightweight or warped pans being used. Use only flat, evenly balanced, medium or heavyweight cookware.
- Voltage is incorrect. Be sure appliance is properly connected to the specified power source.
- Use only flat bottom, evenly balanced, medium or heavyweight cookware. Pans having a flat bottom heat better than warped pans. Cookware material affects heating. Heavy and medium weight pans heat evenly. Because lightweight pans heat unevenly, foods may burn easily.



## FOOD NOT HEATING EVENLY

- Improper cookware. Select flat-bottomed cookware of a proper size to fit element.
- Incorrect control setting. Raise or lower setting until proper amount of heat is obtained.

## SCRATCHES OR ABRASIONS ON CERAMIC GLASS COOKTOP SURFACE

- Coarse particles (such as salt or sand) are between cooktop and utensil. Be sure cooktop surface and bottom of utensils are clean before use. Small scratches do not affect cooking and will become less visible with use.
- Cleaning materials not recommended for glass ceramic cooktop have been used. See **Ceramic-Glass Cooktop** section in this Owner's Guide.
- Cookware with rough bottom has been used. Use flat-bottomed, smooth utensils. See **Selecting Surface Cooking Utensils** in this Owner's Guide.

## METAL MARKS ON CERAMIC GLASS COOKTOP SURFACE

- Sliding or scraping of metal utensils on cooktop surface. Do not slide metal utensils on cooktop surface. Use a mildly abrasive cleanser to remove marks.

## BROWN STREAKS AND SPECKS ON CERAMIC GLASS COOKTOP SURFACE

- Boilovers have cooked onto surface. Use razor blade scraper to remove soil. See instructions under **General Care & Cleaning**.
- Cleaning materials not recommended for ceramic-glass cooktop have been used. Use recommended cleaners and cleaning method. See **Ceramic-Glass Cooktop** section in this Owner's Guide.

## AREAS OF DISCOLORATION ON CERAMIC GLASS COOKTOP SURFACE

---

- Mineral deposits from water and food. Wet surface with water and sprinkle on a cooktop cleaning creme. Scrub with a clean damp paper towel until the stain disappears. Wipe remaining paste away, then apply a small amount of cooktop cleaning creme and polish with a clean paper towel. Use cookware with clean, dry bottoms. See **Ceramic-Glass Cooktop** section in this Owner's Guide.



# Warranty Information

## COOKTOP WARRANTY *Your cooktop is protected by this warranty*

In the U.S.A., your appliance is warranted by Electrolux Home Products North America, a division of White Consolidated Industries, Inc. We authorize no person to change or add to any of our obligations under this warranty. Our obligations for service and parts under this warranty must be performed by us or an authorized Electrolux Home Products North America servicer. In Canada, your appliance is warranted by Electrolux Canada Corp.

	WARRANTY PERIOD	THROUGH OUR AUTHORIZED SERVICERS, WE WILL:	THE CONSUMER WILL BE RESPONSIBLE FOR:
<b>FULL ONE-YEAR WARRANTY</b>	One year from original purchase date	Pay all costs for repairing or replacing any parts of this appliance which prove to be defective in materials or workmanship.	Costs of service calls that are listed under NORMAL RESPONSIBILITIES OF THE CONSUMER. *
<b>LIMITED 2<sup>nd</sup>-5<sup>th</sup> YEAR WARRANTY</b> (Glass Smoothtop, Seal & Elements)	Second through fifth years from original purchase date	Provide a replacement for any defective surface heating element, deteriorated rubberized-silicone seal (upswept models only), or glass smoothtop that cracks due to thermal breakage (not customer abuse).	Diagnostic and any transportation and labor costs which are required because of service.
<b>LIMITED WARRANTY</b> (Applicable to the State of Alaska)	Time periods listed above.	All of the provisions of the full and limited warranties above and the exclusion listed below apply.	Costs of the technician's travel to the home and any costs for pick up and delivery of the appliance required because of service.

### \*NORMAL RESPONSIBILITIES OF THE CONSUMER

This warranty applies only to products in ordinary household use, and the consumer is responsible for the items listed below:

1. Proper use of the appliance in accordance with instructions provided with the product.
2. Proper installation by an authorized servicer in accordance with instructions provided with the appliance and in accordance with all local plumbing, electrical and/or gas codes.
3. Proper connection to a grounded power supply of sufficient voltage, replacement of blown fuses, repair of loose connections or defects in house wiring.
4. Expenses for making the appliance accessible for servicing, such as removal of trim, cupboards, shelves, etc., which are not a part of the appliance when it was shipped from the factory.
5. Damages to finish after installation.
6. Replacement of light bulbs and/or fluorescent tubes (on models with these features).

### EXCLUSIONS

This warranty does not cover the following:

1. CONSEQUENTIAL OR INCIDENTAL DAMAGES SUCH AS PROPERTY DAMAGE AND INCIDENTAL EXPENSES RESULTING FROM ANY BREACH OF THIS WRITTEN OR ANY IMPLIED WARRANTY.  
**NOTE:** Some states do not allow the exclusion or limitation of incidental or consequential damages, so this limitation or exclusion may not apply to you.
2. Service calls which do not involve malfunction or defects in workmanship or material, or for appliances not in ordinary household use. The consumer shall pay for such service calls.
3. Damages caused by services performed by servicers other than Electrolux Home Products North America or its authorized servicers; use of parts other than genuine Electrolux Home Products parts; obtained from persons other than such servicers; or external causes such as abuse, misuse, inadequate power supply or acts of God.
4. Products with original serial numbers that have been removed or altered and cannot be readily determined.

### IF YOU NEED SERVICE

Keep your bill of sale, delivery slip, or some other appropriate payment record. The date on the bill establishes the warranty period should service be required. If service is performed, it is in your best interest to obtain and keep all receipts. This written warranty gives you specific legal rights. You may also have other rights that vary from state to state. Service under this warranty must be obtained by contacting Electrolux Home Products:

**USA**  
1-800-944-9044  
Electrolux Home Products  
North America  
P.O. Box 212378  
Augusta, GA 30917

**Canada**  
1-866-294-9911  
Electrolux Home Products  
North America  
802, boul. L'Ange-Gardien  
L'Assomption, Québec  
J5W 1T6

This warranty only applies in the 50 states of the U.S.A., Puerto Rico, and Canada. Product features or specifications as described or illustrated are subject to change without notice. All warranties are made by Electrolux Home Products North America, a division of White Consolidated Industries, Inc. In Canada, your appliance is warranted by Electrolux Canada Corp.