



# Spacemaker Microwave Oven

*Safety Instructions* . . . . . 2-7

*Operating Instructions*

Care and Cleaning . . . . . 37-40

Cooking Features . . . . . 12-18

Defrosting Features . . . . . 21-27

Easy Guide™ Menu System . . . . . 9

Help Features . . . . . 34

Home Screen . . . . . 10

Microwave Oven Features . . . . . 8

Microwave Terms . . . . . 36

Options . . . . . 28-32

Other Features . . . . . 33, 35

Power Levels . . . . . 11

Reheating Features . . . . . 19-20

*Troubleshooting Tips* . . . . . 41

*Consumer Support*

Consumer Support . . . Back Cover

Warranty . . . . . 42

**Owner's Manual**

CVM2072

**Write the model and serial numbers here:**

**Model #** \_\_\_\_\_

**Serial #** \_\_\_\_\_

Find these numbers on a label on the left front when the door is open.

# IMPORTANT SAFETY INSTRUCTIONS

---

## ***PRECAUTIONS TO AVOID POSSIBLE EXPOSURE TO EXCESSIVE MICROWAVE ENERGY***

- (a) **Do Not Attempt** to operate this oven with the door open since open-door operation can result in harmful exposure to microwave energy. It is important not to defeat or tamper with the safety interlocks.
- (b) **Do Not Place** any object between the oven front face and the door or allow soil or cleaner residue to accumulate on sealing surfaces.
- (c) **Do Not Operate** the oven if it is damaged. It is particularly important that the oven door close properly and that there is no damage to the:
  - (1) door (bent),
  - (2) hinges and latches (broken or loosened),
  - (3) door seals and sealing surfaces.
- (d) **The Oven Should Not** be adjusted or repaired by anyone except properly qualified service personnel.

***SAVE THESE INSTRUCTIONS***

# IMPORTANT SAFETY INSTRUCTIONS

---

**▲ WARNING!** *To reduce the risk of burns, electric shock, fire, injury to persons, or exposure to excessive microwave energy:*

## SAFETY PRECAUTIONS

*Use this appliance only for its intended purpose as described in this Owner's Manual. When using electrical appliances, basic safety precautions should be followed, including the following:*

- This microwave oven is UL listed for installation over electric and gas ranges.
- This microwave oven is not approved or tested for marine use.
- Read and follow the specific precautions in the Precautions to Avoid Possible Exposure to Excessive Microwave Energy section on page 2.
- This appliance must be grounded. Connect only to properly grounded outlet. See the Grounding Instructions section on page 7.
- Install or locate this appliance only in accordance with the provided Installation Instructions.
- Do not mount this appliance over a sink.
- This over-the-range oven was designed for use over ranges no wider than 36." It may be installed over both gas and electric cooking equipment.
- Do not operate this appliance if it has a damaged power cord or plug, if it is not working properly or if it has been damaged or dropped. If the power cord is damaged, it must be replaced by General Electric Service or an authorized service agent using a power cord available from General Electric.
- Do not cover or block any openings on the appliance.
- Use this appliance only for its intended use as described in this manual. Do not use corrosive chemicals or vapors in this appliance. This microwave oven is specifically designed to heat, dry or cook food, and is not intended for laboratory or industrial use.
- Do not store this appliance outdoors. Do not use this product near water—for example, in a wet basement, near a swimming pool, near a sink, or in similar locations.
- Keep power cord away from heated surfaces.
- Do not immerse power cord or plug in water.
- To reduce the risk of fire in the oven cavity:
  - Do not overcook food. Carefully attend appliance when paper, plastic or other combustible materials are placed inside the oven while cooking.
  - Remove wire twist-ties and metal handles from paper or plastic containers before placing them in the oven.
  - Do not use the oven for storage purposes. Do not leave paper products, cooking utensils or food in the oven when not in use.
  - If materials inside oven ignite, keep the oven door closed, turn the oven off and disconnect the power cord, or shut off power at the fuse or circuit breaker panel. If the door is opened, the fire may spread.
  - Do not use the Sensor Features twice in succession on the same food portion. If food is undercooked after the first countdown, use TIME COOK for additional cooking time.
- See door surface cleaning instructions in the *Care and Cleaning of the microwave oven* section of this manual.
- This appliance should be serviced only by qualified service personnel. Contact nearest authorized service facility for examination, repair or adjustment.
- As with any appliance, close supervision is necessary when used by children.
- Do not store anything directly on top of the microwave oven surface when the microwave oven is in operation.

**SAVE THESE INSTRUCTIONS**

# IMPORTANT SAFETY INSTRUCTIONS

---

## **▲ WARNING!**

### *ARCING*

*If you see arcing, press the OFF pad and correct the problem.*

Arcing is the microwave term for sparks in the oven. Arcing is caused by:

- The metal shelf not installed correctly so it touches the microwave wall.
- Metal or foil touching the side of the oven.
- Foil not molded to food (upturned edges act like antennas).
- Metal, such as twist-ties, poultry pins or goldrimmed dishes, in the microwave.
- Recycled paper towels containing small metal pieces being used in the microwave.

---

### *VENT FAN*

The fan will operate automatically under certain conditions (see Automatic Fan feature). Take care to prevent the starting and spreading of accidental cooking fires while the vent fan is in use.

- Clean the underside of the microwave often. Do not allow grease to build up on the microwave or the fan filters.
- In the event of a grease fire on the surface units below the microwave oven, smother a flaming pan on the surface unit by covering the pan completely with a lid, cookie sheet or flat tray.
- Use care when cleaning the vent fan filters. Corrosive cleaning agents, such as lye-based oven cleaners, may damage the filters.
- When preparing flaming foods under the microwave, turn the fan on.
- Never leave surface units beneath your microwave oven unattended at high heat settings. Boilovers cause smoking and greasy spillovers that may ignite and spread if the microwave vent fan is operating. To minimize automatic fan operation, use adequate-sized cookware and use high heat on surface units only when necessary.

***SAVE THESE INSTRUCTIONS***

# IMPORTANT SAFETY INSTRUCTIONS

---

## **▲ WARNING!**

### *FOODS*

- Do not pop popcorn in your microwave oven unless in a special microwave popcorn accessory or unless you use popcorn labeled for use in microwave ovens.
- Some products such as whole eggs and sealed containers—for example, closed jars—are able to explode and should not be heated in this microwave oven. Such use of the microwave oven could result in injury.
- Do not boil eggs in a microwave oven. Pressure will build up inside egg yolk and will cause it to burst, possibly resulting in injury.
- Operating the microwave with no food inside for more than a minute or two may cause damage to the oven and could start a fire. It increases the heat around the magnetron and can shorten the life of the oven.
- Foods with unbroken outer “skin” such as potatoes, hot dogs, sausages, tomatoes, apples, chicken livers and other giblets and egg yolks should be pierced to allow steam to escape during cooking.
- Hot foods and steam can cause burns. Be careful when opening any containers of hot food, including popcorn bags, cooking pouches and boxes. To prevent possible injury, direct steam away from hands and face.
- Avoid heating baby food in glass jars, even with the lid off. Make sure all infant food is thoroughly cooked. Stir food to distribute the heat evenly. Be careful to prevent scalding when warming formula or breast milk. The container may feel cooler than the milk really is. Always test the milk before feeding the baby.
- **SUPERHEATED WATER**  
Liquids, such as water, coffee or tea are able to be overheated beyond the boiling point without appearing to be boiling. Visible bubbling or boiling when the container is removed from the microwave oven is not always present. **THIS COULD RESULT IN VERY HOT LIQUIDS SUDDENLY BOILING OVER WHEN THE CONTAINER IS DISTURBED OR A SPOON OR OTHER UTENSIL IS INSERTED INTO THE LIQUID.**  
To reduce the risk of injury to persons:
  - Do not overheat the liquid.
  - Stir the liquid both before and halfway through heating it.
  - Do not use straight-sided containers with narrow necks.
  - After heating, allow the container to stand in the microwave oven for a short time before removing the container.
  - Use extreme care when inserting a spoon or other utensil into the container.
- Don't defrost frozen beverages in narrow-necked bottles (especially carbonated beverages). Even if the container is opened, pressure can build up. This can cause the container to burst, possibly resulting in injury.
- Do not overcook potatoes. They could dehydrate and catch fire, causing damage to your oven.
- Cook meat and poultry thoroughly—meat to at least an INTERNAL temperature of 160°F and poultry to at least an INTERNAL temperature of 180°F. Cooking to these temperatures usually protects against foodborne illness.

**SAVE THESE INSTRUCTIONS**

# IMPORTANT SAFETY INSTRUCTIONS

---

## ▲ **WARNING!**

### *MICROWAVE-SAFE COOKWARE*

Make sure all cookware used in your microwave oven is suitable for microwaving. Most glass casseroles, cooking dishes, measuring cups, custard cups, pottery or china dinnerware which does not have metallic trim or glaze with a metallic sheen can be used. Some cookware is labeled “suitable for microwaving.”

- If you are not sure if a dish is microwave-safe, use this test: Place in the oven both the dish you are testing and a glass measuring cup filled with 1 cup of water—set the measuring cup either in or next to the dish. Microwave 30–45 seconds at high. If the dish heats, it should not be used for microwaving.



*How to test for a microwave-safe dish*

If the dish remains cool and only the water in the cup heats, then the dish is microwave-safe.

- If you use a meat thermometer while cooking, make sure it is safe for use in microwave ovens.
- Do not use recycled paper products. Recycled paper towels, napkins and waxed paper can contain metal flecks which may cause arcing or ignite. Paper products containing nylon or nylon filaments should be avoided, as they may also ignite.
- Use foil only as directed in this manual. When using foil in the microwave oven, keep the foil at least 1 inch away from the sides of the oven.
- Some styrofoam trays (like those that meat is packaged on) have a thin strip of metal embedded in the bottom. When microwaved, the metal can burn the floor of the oven or ignite a paper towel.

- Do not use the microwave to dry newspapers.
- Not all plastic wrap is suitable for use in microwave ovens. Check the package for proper use.
- Paper towels, waxed paper and plastic wrap can be used to cover dishes in order to retain moisture and prevent spattering. Be sure to vent plastic wrap so steam can escape.
- Cookware may become hot because of heat transferred from the heated food. Pot holders may be needed to handle the cookware.
- “Boilable” cooking pouches and tightly closed plastic bags should be slit, pierced or vented as directed by package. If they are not, plastic could burst during or immediately after cooking, possibly resulting in injury. Also, plastic storage containers should be at least partially uncovered because they form a tight seal. When cooking with containers tightly covered with plastic wrap, remove covering carefully and direct steam away from hands and face.
- Plastic cookware—Plastic cookware designed for microwave cooking is very useful, but should be used carefully. Even microwave-safe plastic may not be as tolerant of overcooking conditions as are glass or ceramic materials, and may soften or char if subjected to short periods of overcooking. In longer exposures to overcooking, the food and cookware could ignite.

#### ***Follow these guidelines:***

- 1 Use microwave-safe plastics only and use them in strict compliance with the cookware manufacturer’s recommendations.
- 2 Do not microwave empty containers.
- 3 Do not permit children to use plastic cookware without complete supervision.

***SAVE THESE INSTRUCTIONS***

# IMPORTANT SAFETY INSTRUCTIONS

---

**▲ WARNING!** *Improper use of the grounding plug can result in a risk of electric shock.*

## GROUNDING INSTRUCTIONS

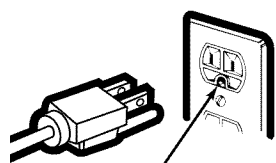

*Ensure proper ground exists before use.*

This appliance must be grounded. In the event of an electrical short circuit, grounding reduces the risk of electric shock by providing

an escape wire for the electric current.

This appliance is equipped with a power cord having a grounding wire with a grounding plug. The plug must be plugged into an outlet that is properly installed and grounded.

Consult a qualified electrician or service technician if the grounding instructions are not completely understood, or if doubt exists as to whether the appliance is properly grounded.

If the outlet is a standard 2-prong wall outlet, it is your personal responsibility and obligation to have it replaced with a properly grounded 3-prong wall outlet.

Do not under any circumstances cut or remove the third (ground) prong from the power cord.

Do not use an adapter plug with this appliance.

Do not use an extension cord with this appliance. If the power cord is too short, have a qualified electrician or service technician install an outlet near the appliance.

For best operation, plug this appliance into its own electrical outlet to prevent flickering of lights, blowing of fuse or tripping of circuit breaker.

## NOTICE – PACEMAKERS

Most pacemakers are shielded from interference from electronic products, including microwaves. However, patients

with pacemakers may wish to consult their physicians if they have concerns.

## SAVE THESE INSTRUCTIONS

---

### OPTIONAL KITS

#### *Filler Panel Kits*

**JX40WH**—White

**JX41**—Black

When replacing a 36" range hood, filler panel kits fill in the additional width to provide a custom built-in appearance.

For installation between cabinets only; not for end-of-cabinet installation. Each kit contains two 3"-wide filler panels.

#### *Filter Kits*

**JX81H**—Recirculating Charcoal Filter Kit

Filter kits are used when the microwave oven cannot be vented to the outside.

Available at extra cost from your GE supplier. See the back cover for ordering by phone or at [ge.com](http://ge.com).

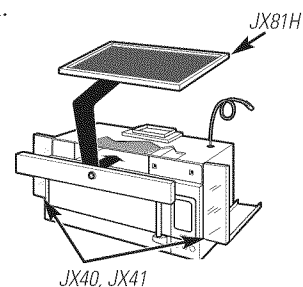

Throughout this manual, features and appearance may vary from your model.

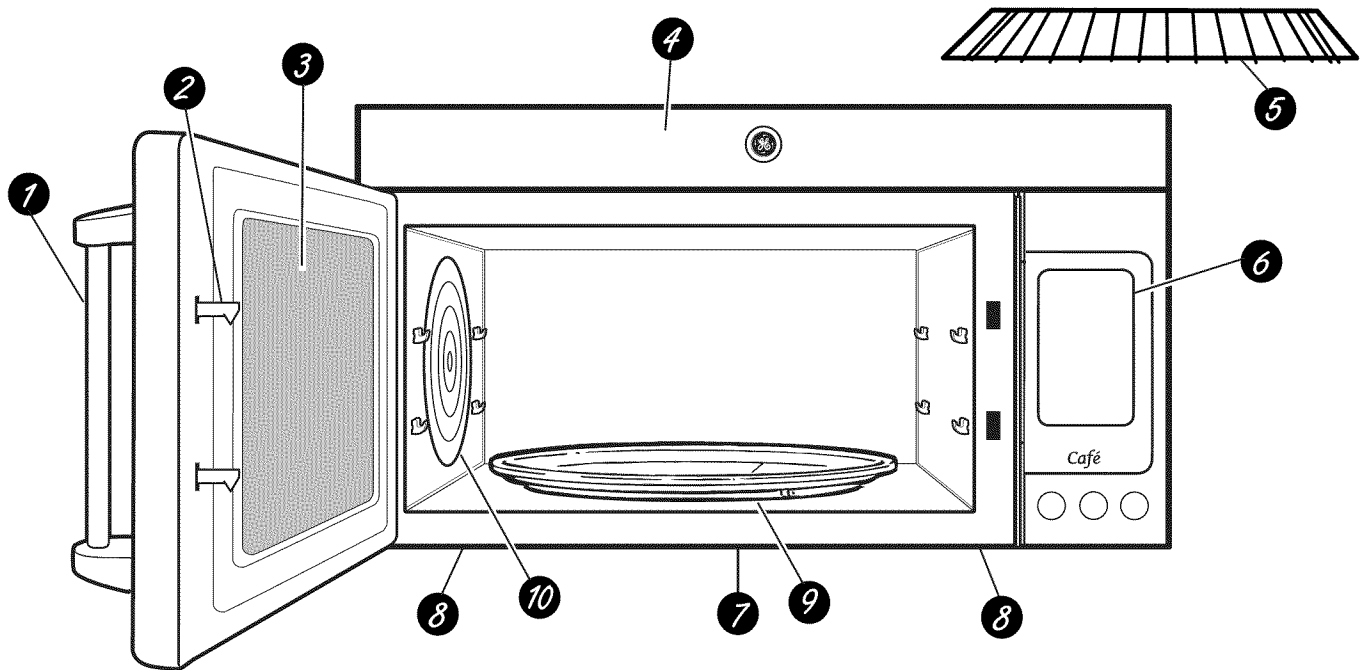

## Features of the microwave oven

- 1 Door Handle.** Pull to open the door. The door must be securely latched for the microwave to operate.
- 2 Door Latches.**
- 3 Window with Metal Shield.** Screen allows cooking to be viewed while keeping microwaves confined in the oven.
- 4 Active Vent.** The vent door swings open when the fan operates and closes when the fan shuts off.
- 5 Shelf.** Lets you microwave several foods at once. Food microwaves best when placed directly on the turntable.  
  
Only use the shelf when reheating on more than one level. Do not store the shelf inside the oven cavity.
- 6 Touchscreen Display.** Press the graphics on the interactive display to use the oven features.  
  
If the Touchscreen is dark, press **HOME** or the Touchscreen, or open the door to access the menu.
- 7 Cooktop Light.**
- 8 Grease Filters.**
- 9 Removable Turntable.** Turntable and support must be in place when using the oven. The turntable may be removed for cleaning.
- 10 Side Stirrer.** Helps circulate microwaves throughout the oven cavity for consistent heating and defrosting. **Do not remove the cover from the side stirrer.**

**NOTE:** Rating plate is located on the left front when the door is open. Oven vent(s) and oven light are located on the inside walls of the microwave oven.



## Using the EasyGuide™ Menu System

The easy-to-use touchscreen system automatically leads you through each step of the cooking process.

It lets you select as many or as few options as you need for the results you want.

### Example: Setting a timed cooking program

**1** Select **COOK** from the touchscreen.

**2** Select **TIME COOK** from the touchscreen.

**3** Enter the cooking time using the numbers on the touchscreen. Press **ENTER** when finished or **CLEAR** to erase the time you entered.

**4** The Summary Screen will allow you to add 30 seconds to the cooking program, or change the power level during cooking (on some functions). Check to make sure the time and power level are correct, and press **START** on the touchscreen.

When cooking is finished, remove the food from the oven.

# Home Screen

ge.com

## Features of the Home Screen

The Home Screen is the starting point for setting any cooking or defrost program, or for setting microwave options.

You can reach the Home Screen at any time by pressing the **HOME** pad below the touchscreen.

If the touchscreen is dark, press **HOME** or the touchscreen to access the menu.

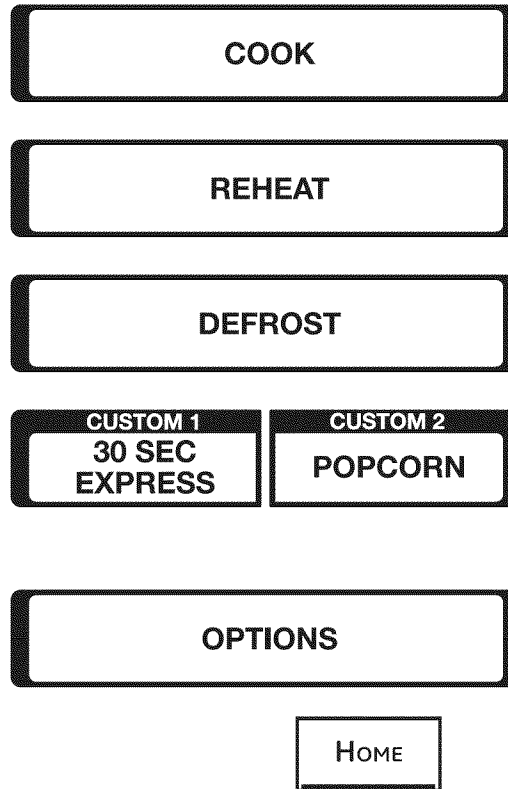

Feature	Description
<b>COOK</b>	Press to cook by time, or by microwave sensor food selection. See “Cooking Features.”
<b>REHEAT</b>	Press to choose from a variety of foods for reheating. See “Reheat Features.”
<b>DEFROST</b>	Press to defrost foods by time, weight or food type. See “Defrost Features.”
<b>CUSTOM 1 and CUSTOM 2</b>	Press for one-touch access to several of the oven’s cooking functions. Cooking functions can be customized using <b>OPTIONS</b> .
<b>OPTIONS</b>	Press to set microwave options and features. See “Microwave Options.” <ul style="list-style-type: none"> <li>• Set the clock</li> <li>• Set a Reminder</li> <li>• Set the beeper volume</li> <li>• Set the custom functions available on the Home Screen</li> <li>• Set the timer</li> <li>• Set the Auto Nite Light</li> <li>• Turn the turntable on or off</li> <li>• Set the charcoal filter reminder</li> <li>• Set options for the touchscreen display</li> </ul>

## Variable Power Levels 1–10

The power level may be entered or changed immediately after entering the feature time for:

- Time Cook
- Time Defrost
- Express Cook
- Reheating Pizza, Casserole or Rice

The power level may also be changed during time countdown.

- 1 From the Home Screen, select **COOK**, **DEFROST** or **REHEAT**.
- 2 From the Cook Screen, select **TIME COOK** or **EXPRESS**. From the Defrost Screen, select **BY TIME**. From the Reheat Screen, select **PIZZA**, **CASSEROLE** or **RICE**.
- 3 Enter the cooking or defrosting time and press **ENTER**, or select a reheat food type.
- 4 On the Summary Screen, press **POWER LEVEL**.
- 5 Using the arrow pads, select desired power level 1–10.
- 6 Press **ENTER** to enter the new power level or **CANCEL** to cancel your selection.

Variable power levels add flexibility to your microwave cooking. The power levels on your microwave oven can be compared to the surface units on a range. Each power level gives you microwave energy a certain percent of the time. Power level 7 is microwave energy 70% of the time. Power level 3 is microwave energy 30% of the time. Most cooking will be done on High (power level 10) which gives you 100% power.

Power level 10 will cook faster but food may need more frequent stirring, rotating or turning over. A lower setting will cook more evenly and need less stirring or rotating of the food.

Some foods may have better flavor, texture or appearance if one of the lower settings is used. Use a lower power level when cooking foods that have a tendency to boil over, such as scalloped potatoes.

Rest periods (when the microwave energy cycles off) give time for the food to “equalize” or transfer heat to the inside of the food. An example of this is shown with power level 3—the defrost cycle. If microwave energy did not cycle off, the outside of the food would cook before the inside was defrosted.

## POWER LEVEL

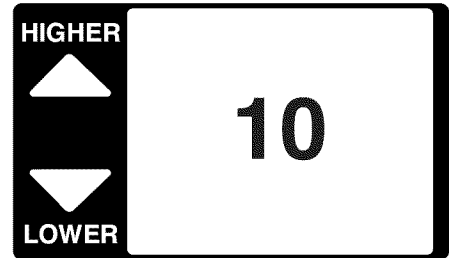

Here are some examples of uses for various power levels:

POWER LEVEL	BEST USES
High 10	Fish, bacon, vegetables, boiling liquids.
Med-High 7	Gentle cooking of meat and poultry; baking casseroles and reheating.
Medium 5	Slow cooking and tenderizing such as stews and less tender cuts of meat.
Low 3	Defrosting without cooking; simmering; delicate sauces.
Warm 1	Keeping food warm without overcooking; softening butter.

## Features of the COOK Screen

The Cook Screen allows you to choose from a variety of functions to microwave by time or with the sensor features.

*NOTE: Do not use the metal shelf when using the features found in Select Food or Select Beverage.*

### COOK



Press	Enter	Option
<b>EXPRESS</b>	Amount of cooking time— Starts immediately!	
<b>TIME COOK</b>	Amount of cooking time.	
<b>SELECT FOOD</b>	Food type, food weight/ quantity (some food types)	More done/Less done
<b>SELECT BEVERAGES</b>	Beverage type—Starts immediately!	
<b>SOFTEN</b>	Food type.	
<b>MELT</b>	Food type, food weight.	
<b>TIME COOK 1 &amp; 2</b>	Amount of cooking time and power level for first and second cooking programs.	
<b>DELAY</b>	Cooking or defrosting function and time of day to start.	

### *Time Cook*

Time Cook allows you to microwave for any time up to 99 minutes and 99 seconds.

Power level 10 (High) is automatically set, but you may change it for more flexibility.

- 1 From the Home Screen, select **COOK**.
- 2 From the Cook Screen, select **TIME COOK**.
- 3 Enter the cooking time using the numbers on the touchscreen. Press **ENTER** when finished or **CLEAR** to erase the time you entered.
- 4 From the Summary Screen, select **ADD 30 SEC** if you wish to add 30 seconds to the cook time, or select **POWER LEVEL** if you don't want full power.
- 5 Check to make sure the time and power level are correct, and press **START** on the touchscreen.

You may open the door during Time Cook to check the food. Close the door and press **START** to resume cooking.

A rectangular button with a black border and the text "TIME COOK" in bold, uppercase letters.

### *Time Cook 1 & 2*

Time Cook 1 & 2 lets you change power levels automatically during cooking.

- 1 From the Home Screen, select **COOK**.
- 2 From the Cook Screen, select **TIME COOK 1 & 2**.
- 3 Enter the first cooking time using the numbers on the touchscreen. Press **ENTER** when finished or **CLEAR** to erase the time you entered.
- 4 Using the arrow pads, select desired power level 1–10 for the first cooking time. Press **ENTER** to enter the new power level or **CANCEL** to cancel your selection.
- 5 Enter the second cooking time using the numbers on the touchscreen. Press **ENTER** when finished or **CLEAR** to erase the time you entered.
- 6 Using the arrow pads, select desired power level 1–10 for the second cooking time. Press **ENTER** to enter the new power level or **CANCEL** to cancel your selection.
- 7 Check to make sure the time and power level are correct, and press **START** on the touchscreen.

At the end of Time Cook 1, Time Cook 2 counts down.

A rectangular button with a black border and the text "TIME COOK 1 & 2" in bold, uppercase letters.

## Cooking Features

*ge.com*

### Cooking Guide for Time Cook

<b>Vegetable</b>	<b>Amount</b>	<b>Time</b>	<b>Comments</b>
<b>Asparagus</b> (fresh spears)	1 lb.	6 to 9 min., Med-High (7)	In 1½-qt. oblong glass baking dish, place 1/4 cup water.
(frozen spears)	10-oz package	5 to 7 min.	In 1-qt. casserole.
<b>Beans</b> (fresh green)	1 lb. cut in half	9 to 11 min.	In 1½-qt. casserole, place 1/2 cup water.
(frozen green)	10-oz package	6 to 8 min.	In 1-qt. casserole, place 2 tablespoons water.
(frozen lima)	10-oz package	6 to 8 min.	In 1-qt. casserole, place 1/4 cup water.
<b>Beets</b> (fresh, whole)	1 bunch	17 to 21 min.	In 2-qt. casserole, place 1/2 cup water.
<b>Broccoli</b> (fresh cut)	1 bunch (1¼ to 1½ lbs.)	7 to 10 min.	In 2-qt. casserole, place 1/2 cup water.
(fresh spears)	1 bunch (1¼ to 1½ lbs.)	9 to 13 min.	In 2-qt. oblong glass baking dish, place 1/4 cup water.
(frozen, chopped)	10-oz package	5 to 7 min.	In 1-qt. casserole.
(frozen spears)	10-oz package	5 to 7 min.	In 1-qt. casserole, place 3 tablespoons water.
<b>Cabbage</b> (fresh)	1 medium head (about 2 lbs.)	8 to 11 min.	In 1½- or 2-qt. casserole, place 1/4 cup water.
(wedges)		7 to 10 min.	In 2- or 3-qt. casserole, place 1/4 cup water.
<b>Carrots</b> (fresh, sliced)	1 lb.	7 to 9 min.	In 1½-qt. casserole, place 1/4 cup water.
(frozen)	10-oz package	5 to 7 min.	In 1-qt. casserole, place 2 tablespoons water.
<b>Cauliflower</b> (flowerets)	1 medium head	9 to 14 min.	In 2-qt. casserole, place 1/2 cup water.
(fresh, whole)	1 medium head	10 to 17 min.	In 2-qt. casserole, place 1/2 cup water.
(frozen)	10-oz package	5 to 7 min.	In 1-qt. casserole, place 2 tablespoons water.
<b>Corn</b> (frozen kernel)	10-oz package	5 to 7 min.	In 1-qt. casserole, place 2 tablespoons water.
<b>Corn on the cob</b> (fresh)	1 to 5 ears	3 to 4 min. per ear	In 2-qt. oblong glass baking dish, place corn. If corn is in husk, use no water; if corn has been husked, add 1/4 cup water. Rearrange after half of time.
(frozen)	1 ear 2 to 6 ears	5 to 6 min. 3 to 4 min. per ear	Place in 2-qt. oblong glass baking dish. Cover with vented plastic wrap. Rearrange after half of time.
<b>Mixed vegetables</b> (frozen)	10-oz package	5 to 7 min.	In 1-qt. casserole, place 3 tablespoons water.
<b>Peas</b> (fresh, shelled)	2 lbs. unshelled	9 to 12 min.	In 1-qt. casserole, place 1/4 cup water.
(frozen)	10-oz package	5 to 7 min.	In 1-qt. casserole, place 2 tablespoons water.
<b>Potatoes</b> (fresh, cubed, white)	4 potatoes (6 to 8 oz each)	9 to 12 min.	Peel and cut into 1 inch cubes. Place in 2-qt. casserole with 1/2 cup water. Stir after half of time.
(fresh, whole, sweet or white)	1 (6 to 8 oz)	3 to 4 min.	Pierce with cooking fork. Place in center of the oven. Let stand 5 minutes.
<b>Spinach</b> (fresh)	10 to 16 oz	5 to 7 min.	In 2-qt. casserole, place washed spinach.
(frozen, chopped and leaf)	10-oz package	5 to 7 min.	In 1-qt. casserole, place 3 tablespoons water.
<b>Squash</b> (fresh, summer and yellow)	1 lb. sliced	5 to 7 min.	In 1½-qt. casserole, place 1/4 cup water.
(winter, acorn, butternut)	1 to 2 squash (about 1 lb. each)	8 to 11 min.	Cut in half and remove fibrous membranes. In 2-qt. oblong glass baking dish, place squash cut-side-down. Turn cut-side-up after 4 minutes.

## Express Cook

This is a quick way to set cooking time from 30 seconds to 6 minutes.

- 1 From the Home Screen, select **COOK**.
- 2 From the Cook Screen, select **EXPRESS**.
- 3 Select the cooking time from the touchscreen. The oven starts immediately.

### EXPRESS

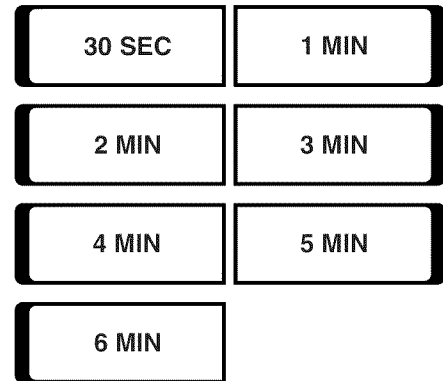

## Humidity Sensor

Some microwave features are Sensor functions that detect the increasing humidity released during cooking. The oven automatically adjusts the cooking time to various types and amounts of food.

When using Sensor features, do not open the oven door until time is counting down. If the door is opened, close it and press **START** immediately.

Do not use the Sensor Features twice in succession on the same food portion—it may result in severely overcooked or burnt food. If food is undercooked after the countdown, use **TIME COOK** for additional cooking time.

If you wish to adjust the cooking time, press **LESS DONE** or **MORE DONE** within the first 30 seconds to reduce or add time.

- The proper containers and covers are essential for best sensor cooking.
- Always use microwave-safe containers and cover them with lids or vented plastic wrap. Never use tight-sealing plastic covers—they can prevent steam from escaping and cause food to overcook.
- Be sure the outside of the cooking container and the inside of the microwave oven are dry before placing food in the oven. Beads of moisture turning into steam can mislead the sensor.



Covered

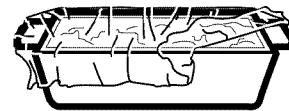

Vented

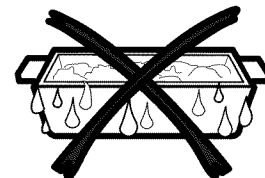

Dry off dishes so they don't mislead the sensor.

### Microwave Sensor Features

- |                  |                     |               |
|------------------|---------------------|---------------|
| • Popcorn        | • Fresh vegetables  | • Ground meat |
| • Potato         | • Frozen vegetables | • Fish        |
| • Chicken pieces | • Canned vegetables | • Rice        |

## Cooking Features

ge.com

### Microwaving by Food Type

*NOTE: Do not use the metal shelf with features found in Select Food.*

*NOTE: Do not use this feature twice in succession on the same food portion—it may result in severely overcooked or burnt food.*

The Select Food feature gives you easy, automatic results with a variety of foods (see the Cooking Guide below).

- 1 Place covered food in the oven.
- 2 From the Home Screen, select **COOK**.
- 3 From the Cook Screen, choose **SELECT FOOD**.
- 4 Select the food type from the touchscreen. You can find additional food types by pressing **MORE** at the bottom of the touchscreen.
- 5 **For Sensor features**, the oven starts immediately after selecting the food type.
- 6 **For non-sensor features**, enter the description, weight or quantity. Press **ENTER** after each entry or **CLEAR** to erase the entry. Press **START** to begin cooking.

#### SELECT FOOD

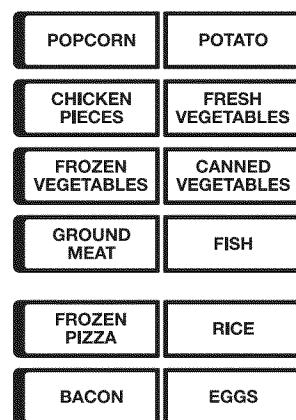

If food is undercooked after the countdown, use **TIME COOK** for additional cooking time.

Food Type	Amount	Comments
Popcorn	3.0 to 3.5 ounce bag	Follow package instructions, using Time Cook if the package is less than 3.0 ounces or larger than 3.5 ounces.
Potato	8–32 oz.	Pierce skin with fork. Place potatoes on the turntable.
Chicken Pieces	2–8 pieces	Cover with vented plastic wrap.
Fresh Vegetable	4–16 oz.	Add 1/4 cup water per serving. Cover with lid or vented plastic wrap.
Frozen Vegetable	4–16 oz.	Follow package instructions for adding water. Cover with lid or vented plastic wrap.
Canned Vegetable	4–16 oz.	Cover with lid or vented plastic wrap.
Ground Meat	1/2 to 2 lbs.	Do not cover dish; drain and stir at signal.
Fish	4–16 oz.	Cover with vented plastic wrap.
Frozen Pizza	4–16 oz.	
Rice	1/2 to 2 cups	For long-cooking rice (not instant rice), follow package instructions for addition of water. Use large dish; cover with lid or vented plastic wrap.
Bacon	1 to 10 slices	Layer slices in paper towels on a plate, 4 slices per layer with paper towel between and one on top.
Eggs	1 to 12 eggs	Place eggs in measuring cup or bowl. Stir after 1/2 time.



## Microwaving Popcorn

*NOTE: Do not use the metal shelf when microwaving popcorn.*

*NOTE: Do not use this feature twice in succession on the same food portion—it may result in severely overcooked or burnt food.*

Use only with prepackaged microwave popcorn weighing 3.0 to 3.5 ounces.

**1** Follow package instructions, using Time Cook if the package is less than 3.0 ounces or larger than 3.5 ounces. Place the package of popcorn in the center of the microwave.

**2** From the Home Screen, select **COOK**.

**3** From the Cook Screen, choose **SELECT FOOD**.

**4** Select **POPCORN** from the touchscreen. The oven starts immediately.

Do not open the oven door until time is counting down. If the door is opened, close it and press **START** immediately.

If food is undercooked after the countdown, use **TIME COOK** for additional cooking time.

If you find that the brand of popcorn you use underpops or overpops consistently, you can add or subtract 20–30 seconds to the automatic popping time.

### To add time:

After pressing **POPCORN**, press **MORE DONE** within the first 30 seconds after the oven starts for an extra 20 seconds of cooking time. Press **MORE DONE** again to add another 10 seconds (total of 30 seconds additional time).

### To subtract time:

After pressing **POPCORN**, press **LESS DONE** within the first 30 seconds after the oven starts for 20 seconds less cooking time. Press **LESS DONE** again to reduce cooking time another 10 seconds (total of 30 seconds less time).

## Microwaving by Beverage Type

*NOTE: Do not use the metal shelf when microwaving beverages.*

*NOTE: Do not use this feature twice in succession on the same food portion—it may result in severely overcooked or burnt food.*

The Select Beverage feature allows you to heat a cup of coffee or other beverage.

**Drinks heated with the Beverage feature may be very hot. Remove the container with care.**

**1** From the Home Screen, select **COOK**.

**2** From the Cook Screen, press **SELECT BEVERAGE**.

**3** Select the beverage type from the touchscreen. The oven starts immediately.

Do not open the oven door. If the door is opened, close it and press **START** immediately.

If food is undercooked after the countdown, use **TIME COOK** for additional cooking time.

### SELECT BEVERAGE

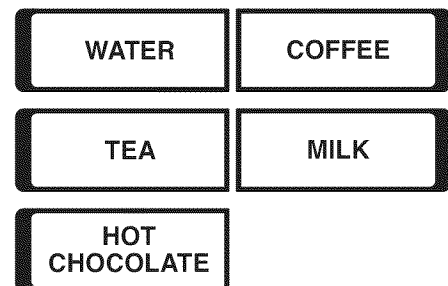

*Using the Soften Feature*

The Soften feature allows you to soften without melting frozen or refrigerated foods.

Unwrap butter or cream cheese and place on plate.

Make sure that foil covers are removed from frosting or ice cream and place the container in the oven.

- 1 From the Home Screen, select **COOK**.
- 2 From the Cook Screen, press **SOFTEN**.
- 3 Select the food type from the touchscreen.
- 4 Check to make sure the time is correct, and press **START** on the touchscreen.

**SOFTEN**



*Using the Melt Feature*

The Melt feature allows you to melt foods for cooking.

- 1 Place the unwrapped item into bowl.  
The Chocolate melting feature is for up to 16 oz. of chocolate morsels (chips).
- 2 From the Home Screen, select **COOK**.
- 3 From the Cook Screen, press **MELT**.
- 4 Select the food type from the touchscreen.
- 5 For all food types except Butter, enter the food weight and press **ENTER**. Press **CLEAR** if you want to clear your previous entry, or press **BACK** to return to the previous screen.
- 6 Check to make sure the time is correct, and press **START** on the touchscreen.
- 7 After removing food from the oven, stir well to complete the melting process.

**MELT**

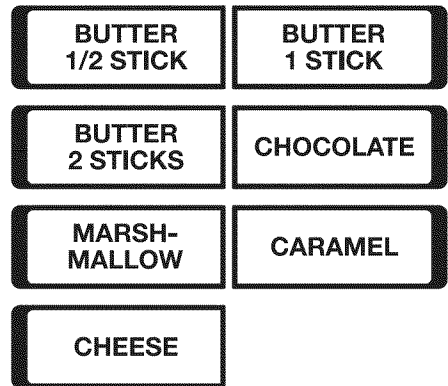

*How to Delay the Start of Cooking*

The Delay feature allows you to set the microwave to delay the start times for Time Cook, Time Cook 1 & 2, and Time Defrost, for up to 24 hours.

- 1 From the Home Screen, select **COOK**.
- 2 From the Cook Screen, press **DELAY**.
- 3 Enter the time you want the oven to start. (Be sure the microwave clock shows the correct time of day.) Press **ENTER** when finished or **CLEAR** to erase the time you entered.
- 4 Select AM or PM. Press **ENTER** when finished or **BACK** to enter a new time.



- 5 Select the cooking or defrosting feature you wish to delay, then set the cooking or defrosting program.
- 6 Check to make sure the Delay time is correct, and press **START** on the touchscreen.

The start time will be displayed and will remain until the oven automatically starts at the delayed time.

## Features of the REHEAT Screen

The Reheat Screen allows you to reheat single servings of previously cooked foods or a plate of leftovers.

### Some Foods Not Recommended For Use With Reheat:

It is best to use Time Cook for these foods:

- Bread products.
- Foods that must be reheated uncovered.
- Foods that need to be stirred or rotated.
- Foods calling for a dry look or crisp surface after reheating.

*NOTE: Do not use the metal shelf when reheating pasta, vegetables, beverages, soup or a plate of leftovers.*

*NOTE: Do not use Sensor Reheating features twice in succession on the same food portion—it may result in severely overcooked or burnt food.*

### REHEAT



Press	Enter	Option	Comments
<b>PLATE</b>	Starts immediately!	More done/ Less done	Cover with lid or vented plastic wrap.
<b>BEVERAGE</b>	Beverage type— Starts immediately!		Use wide mouth mug.
<b>PIZZA, 1–4 slices</b>	Type of crust and number of slices		Do not cover.
<b>PASTA, 8–12 oz.</b>	Starts immediately!	More done/ Less done	Cover with lid or vented plastic wrap.
<b>VEGETABLE, 1/2–2 cups</b>	Starts immediately!	More done/ Less done	Cover with lid or vented plastic wrap.
<b>CASSEROLE, 1–4 cups</b>	Food amount		Cover with lid or vented plastic wrap.
<b>RICE, 1/2–5 cups</b>	Food amount		Cover with lid or vented plastic wrap.
<b>SOUP, 8–24 oz.</b>	Starts immediately!	More done/ Less done	Cover with lid or vented plastic wrap.

### *Convenience Reheating Features*

Convenience reheating features microwave according to food type, quantity and weight.

Use the convenience reheating features to reheat:

- Pizza
- Casserole
- Rice

- 1 From the Home Screen, select **REHEAT**.
- 2 From the Reheat Screen, select the food type.
- 3 Depending on food type, enter the food description, weight or quantity. Press **ENTER** after each entry or **CLEAR** to erase the entry.
- 4 Check to make sure the time and power level are correct, and press **START** on the touchscreen.

**After removing food from the oven, stir, if possible, to even out the temperature. If food is not hot enough, use Time Cook to reheat for more time. Reheated foods may have wide variations in temperature. Some areas may be extremely hot.**

### *Sensor Reheating Features*

Sensor reheating features detect the increasing humidity released during cooking and automatically adjust the cooking time to various types and amounts of food.

Use the sensor reheating features to reheat:

- Plate of leftovers
- Beverages
- Soup
- Pasta
- Vegetable

*NOTE: Do not use the metal shelf when Sensor reheating.*

*NOTE: Do not use this feature twice in succession on the same food portion—it may result in severely overcooked or burnt food.*

- 1 From the Home Screen, select **REHEAT**.
- 2 From the Reheat Screen, select **PLATE, PASTA, VEGETABLE, BEVERAGE** or **SOUP**.
- 3 For **PASTA, VEGETABLE, PLATE** and **SOUP**, the oven starts immediately after selecting the food type. If you wish to adjust the cooking time, press **LESS DONE** or **MORE DONE** within the first 30 seconds to reduce or add time.
- 4 For **BEVERAGE**, select the beverage type. The oven starts immediately.

The oven signals when steam is sensed and the time remaining begins counting down. Turn or stir the food if necessary.

Do not open the oven door until time is counting down. If the door is opened, close it and press **START** immediately.

**After removing food from the oven, stir, if possible, to even out the temperature. Reheated foods may have wide variations in temperature. Some areas may be extremely hot.**

**If food is not hot enough after the countdown time, use Time Cook to reheat for more time.**

*Features of  
the DEFROST  
Screen*

The Defrost Screen allows you to choose from a variety of functions to defrost by time, by weight or by food type.

## DEFROST

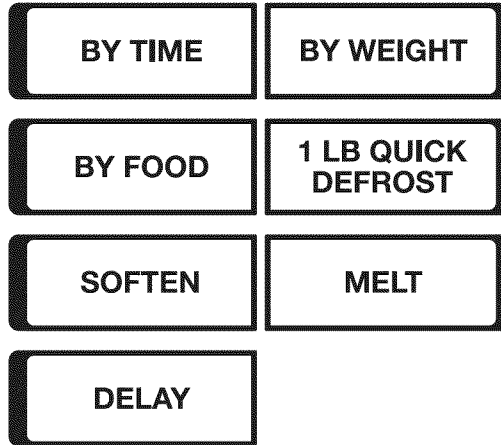

Press	Enter
BY TIME	Amount of cooking time
BY WEIGHT	Food weight
BY FOOD	Food type, food weight
1 LB. QUICK DEFROST	Starts immediately!
SOFTEN	Food type
MELT	Food type, food weight
DELAY	Cooking or defrosting function and time of day to start.

### *Defrosting by Time*

Allows you to defrost for a selected length of time. See the Defrosting Guide for suggested times.

- 1 From the Home Screen, select **DEFROST**.
- 2 From the Defrost Screen, select **BY TIME**.
- 3 Enter the defrosting time using the numbers on the touchscreen. Press **ENTER** when finished or **CLEAR** to erase the time you entered.
- 4 Check to make sure the time and power level are correct, and press **START** on the touchscreen.

For best results, turn food over after half the time and break apart or rearrange pieces for more even defrosting. Shield any warm areas with small pieces of foil.

Power level is automatically set at 3, but can be changed. You can defrost small items quickly by raising the power level after entering the time. Power level 7 cuts the total defrosting time in about half; power level 10 cuts the total time to approximately 1/3. However, food will need more frequent attention than usual.

A dull thumping noise may be heard during defrosting. This is normal when oven is not operating at High power.

**BY TIME**

### Defrosting Tips

- Foods frozen in paper or plastic can be defrosted in the package. Closed packages should be slit, pierced or vented **AFTER** food has partially defrosted. Plastic storage containers should be partially uncovered.
- Family-size, prepackaged frozen dinners can be defrosted and microwaved. If the food is in a foil container, transfer it to a microwave-safe dish.
- For more even defrosting of larger foods, such as roasts, use Auto Defrost. Be sure large meats are completely defrosted before cooking.
- Foods that spoil easily should not be allowed to sit out for more than one hour after defrosting. Room temperature promotes the growth of harmful bacteria.
- When defrosted, food should be cool but softened in all areas. If still slightly icy, return to the microwave very briefly, or let it stand a few minutes.

## Defrosting Features

*ge.com*

*Defrosting  
Guide  
for Time  
Defrost*

<b>Food</b>	<b>Time</b>	<b>Comments</b>
<b>Breads, Cakes</b> <b>Bread, buns or rolls</b> (1 piece) <b>Sweet rolls</b> (approx. 12 oz)	1 min. 3 to 5 min.	
<b>Fish and Seafood</b> <b>Fillets, frozen</b> (1 lb.) <b>Shellfish, small pieces</b> (1 lb.)	6 to 8 min. 5 to 7 min.	Place block in casserole. Turn over and break up after half the time.
<b>Fruit</b> <b>Plastic pouch – 1 to 2</b> (10-oz package)	3 to 6 min.	
<b>Meat</b> <b>Bacon</b> (1 lb.)  <b>Franks</b> (1 lb.)  <b>Ground meat</b> (1 lb.) <b>Roast: beef, lamb, veal, pork</b>  <b>Steaks, chops and cutlets</b>	2 to 5 min.  2 to 5 min.  5 to 7 min. 12 to 16 min. per lb. 5 to 7 min. per lb.	Place unopened package in oven. Let stand 5 minutes after defrosting. Place unopened package in oven. Microwave just until franks can be separated. Let stand 5 minutes, if necessary, to complete defrosting. Turn meat over after half the time. Use power level 1.  Place unwrapped meat in cooking dish. Turn over after half the time and shield warm areas with foil. When finished, separate pieces and let stand to complete defrosting.
<b>Poultry</b> <b>Chicken, broiler-fryer cut up</b> (2½ to 3 lbs.)  <b>Chicken, whole</b> (2½ to 3 lbs.)  <b>Cornish hen</b>  <b>Turkey breast</b> (4 to 6 lbs.)	15 to 19 min.  17 to 21 min.  7 to 13 min. per lb.  5 to 9 min. per lb.	Place wrapped chicken in dish. Unwrap and turn over after half the time. When finished, separate pieces and microwave 2 to 4 minutes more, if necessary. Let stand to finish defrosting. Place wrapped chicken in dish. After half the time, unwrap and turn chicken over. Shield warm areas with foil. Finish defrosting. If necessary, run cold water in the cavity until giblets can be removed. Place unwrapped hen in the oven breast-side-up. Turn over after half the time. Run cool water in the cavity until giblets can be removed. Place unwrapped breast in dish breast-side-down. After half the time, turn over and shield warm areas with foil. Finish defrosting. Let stand 1 to 2 hours in refrigerator to complete defrosting.

## Defrosting by Weight

Defrosting by Weight automatically sets the defrosting times and power levels to give even defrosting results for meats, poultry and fish weighings up to six pounds.

- 1 From the Home Screen, select **DEFROST**.
- 2 From the Defrost Screen, select **BY WEIGHT**.
- 3 Using the Conversion Guide at right, enter the food weight using the numbers on the touchscreen. For example, press 1 and 2 for 1.2 pounds (1 pound, 3 ounces). Press **ENTER** when finished or **CLEAR** to erase the weight you entered.
- 4 Check to make sure the time is correct, and press **START** on the touchscreen.
  - Remove meat from package and place on microwave-safe dish.
  - If the oven signals “TURN FOOD OVER,” turn the food over and break apart or rearrange pieces for more even defrosting. Shield any warm areas with small pieces of foil. The oven will continue to defrost if you don’t open the door and turn the food.
  - After defrosting, most meats need to stand 5 minutes to complete defrosting. Large roasts should stand for about 30 minutes.

**BY WEIGHT**

### Conversion Guide

If the weight of food is stated in pounds and ounces, the ounces must be converted to tenths (0.1) of a pound.

Weight of Food in Ounces	Enter Food Weight (tenths of a pound)
1-2	0.1
3	0.2
4-5	0.3
6-7	0.4
8	0.5
9-10	0.6
11	0.7
12-13	0.8
14-15	0.9

## 1 Lb. Quick Defrost

1 Lb. Quick Defrost automatically sets the defrosting times and power levels for foods weighing one pound.

- Remove meat from package and place on a microwave-safe dish.
- 1 From the Home Screen, select **DEFROST**.
  - 2 From the Defrost Screen, select **1 LB QUICK DEFROST**. The oven starts immediately.

**1 LB QUICK DEFROST**



## Defrosting by Food

Defrosting by Food allows you to specify the food you are defrosting and automatically sets the defrosting times and power levels to give even defrosting results for that type of food.

- 1 From the Home Screen, select **DEFROST**.
  - 2 From the Defrost Screen, select **BY FOOD**.
  - 3 Select the food type from the touchscreen.
  - 4 Using the Conversion Guide at right, enter the food weight using the numbers on the touchscreen. For example, press 1 and 2 for 1.2 pounds (1 pound, 3 ounces). Press **ENTER** when finished. Press **CLEAR** to erase the weight you entered or **BACK** to select a different food type.
  - 5 Check to make sure the food type and time are correct, and press **START** on the touchscreen.
- Remove meat from package and place on microwave-safe dish.
  - If the oven signals “TURN FOOD OVER,” turn the food over and break apart or rearrange pieces for more even defrosting. Shield any warm areas with small pieces of foil. The oven will continue to defrost if you don’t open the door and turn the food.
  - After defrosting, most meats need to stand 5 minutes to complete defrosting. Large roasts should stand for about 30 minutes.

### DEFROST BY FOOD

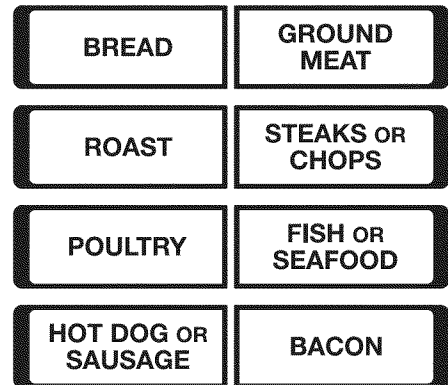

### Conversion Guide

If the weight of food is stated in pounds and ounces, the ounces must be converted to tenths (0.1) of a pound.

Weight of Food in Ounces	Enter Food Weight (tenths of a pound)
1-2	0.1
3	0.2
4-5	0.3
6-7	0.4
8	0.5
9-10	0.6
11	0.7
12-13	0.8
14-15	0.9

## Defrosting Features

ge.com

### Using the Soften Feature

The Soften feature allows you to soften without melting frozen or refrigerated foods.

Unwrap butter or cream cheese and place on plate.

Make sure that foil covers are removed from frosting or ice cream and place the container in oven.

- 1 From the Home Screen, select **DEFROST**.
- 2 From the Cook Screen, press **SOFTEN**.
- 3 Select the food type from the touchscreen.
- 4 Check to make sure the time is correct, and press **START** on the touchscreen.

### SOFTEN

BUTTER  
1/2 STICK

BUTTER  
1 STICK

BUTTER  
2 STICKS

FROSTING  
1 CAN

CREAM  
CHEESE 3 OZ

CREAM  
CHEESE 8 OZ

ICE CREAM  
1 PINT

ICE CREAM  
1 QUART

### Using the Melt Feature

The Melt feature allows you to melt foods for cooking.

- 1 Place the unwrapped item into bowl.  
The Chocolate melting feature is for up to 16 oz. of chocolate morsels (chips).
- 2 From the Home Screen, select **DEFROST**
- 3 From the Defrost Screen, press **MELT**.
- 4 Select the food type from the touchscreen.
- 5 For all food types except Butter, enter the food weight and press **ENTER**. Press **CLEAR** if you want to clear your previous entry, or press **BACK** to return to the previous screen.
- 6 Check to make sure the time is correct, and press **START** on the touchscreen.
- 7 After removing food from the oven, stir well to complete the melting process.

### MELT

BUTTER  
1/2 STICK

BUTTER  
1 STICK

BUTTER  
2 STICKS

CHOCOLATE

MARSH-  
MALLOW

CARAMEL

CHEESE

### *How to Delay the Start of Defrosting*

The Delay feature allows you to set the microwave to delay the start time for Time Cook, Time Cook 1 & 2, and Time Defrost, for up to 24 hours.



- 1 From the Home Screen, select **DEFROST**.
- 2 From the Defrost Screen, select **DELAY**.
- 3 Enter the time you want the oven to start. (Be sure the microwave clock shows the correct time of day.) Press **ENTER** when finished or **CLEAR** to erase the time you entered.
- 4 Select AM or PM. Press **ENTER** when finished or **BACK** to enter a new time.
- 5 Select the cooking or defrosting feature you wish to delay, then set the cooking or defrosting program.
- 6 Check to make sure the Delay time is correct, and press **START** on the touchscreen.

The start time will be displayed and will remain until the oven automatically starts at the delayed time.

*Features  
of the  
OPTIONS  
Screen*

The Options Screen allows you to:

- Set the clock
- Set a countdown timer
- Set a Reminder time
- Set the time for the Auto Nite Light to come on and go off
- Change the Beeper volume
- Turn the turntable on or off
- Change the microwave features controlled by the Custom 1 and Custom 2 features
- Set a reminder to change the charcoal filter
- Change display options

## OPTIONS

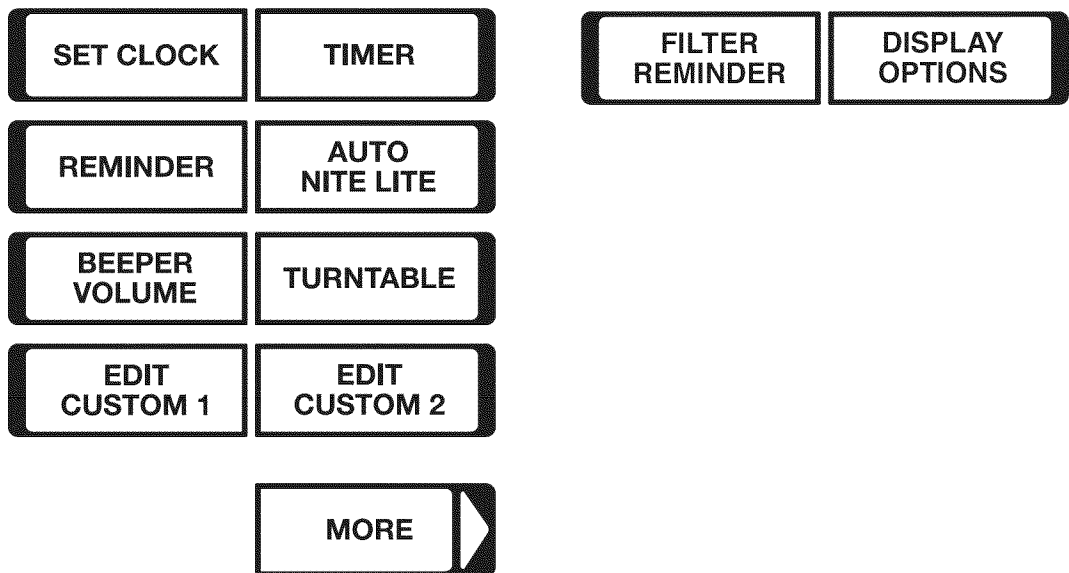

Press	Enter	Option
SET CLOCK	Time of day, AM/PM	
TIMER	Countdown time	
REMINDER	Reminder time, AM/PM	
AUTO NITE LITE	ON time, AM/PM OFF time, AM/PM	
BEEPER VOLUME		LOW, NORMAL, LOUD, MUTE
TURNTABLE		ON, OFF
EDIT CUSTOM 1, EDIT CUSTOM 2		Microwave program
FILTER REMINDER		Reset reminder time
DISPLAY OPTIONS		<ul style="list-style-type: none"> <li>• Clock display ON/OFF</li> <li>• Display contrast 1-5</li> </ul>

## Setting the Clock

Select **SET CLOCK** from the Options Screen to set the time of day.

- 1 From the Home Screen, select **OPTIONS**.
- 2 From the Options Screen, select **SET CLOCK**.
- 3 Using the numbers on the touchscreen, enter the time of day. Press **ENTER** when finished or **CLEAR** to erase the time you entered.
- 4 Select **AM** or **PM** from the touchscreen. Press **ENTER** when finished or **BACK** to enter a new time.

A rectangular button with a black border and the text "SET CLOCK" in bold, uppercase letters.

## Setting the Timer

Timer operates as a minute timer and can be used at any time, even when the oven is operating.

- 1 From the Home Screen, select **OPTIONS**.
- 2 From the Options Screen, select **TIMER**.
- 3 Using the numbers on the touchscreen, enter time you want to count down. Press **ENTER** when finished or **CLEAR** to erase the time you entered.
- 4 Press **START**.

A rectangular button with a black border and the text "TIMER" in bold, uppercase letters.

To cancel the timer, press **TIMER OFF**.

When time is up, the oven will signal. To turn off the timer signal, press **TIMER OFF**.

**NOTE:** If the timer is operating while microwaving, press **DISPLAY TIMER** or **DISPLAY COOK TIME** to view the time remaining on the timer or cooking program.

## Setting the Reminder

The Reminder feature can be used like an alarm clock, and can be used at any time, even when the oven is operating. The Reminder time can be set up to 24 hours later.

- 1 From the Home Screen, select **OPTIONS**.
- 2 From the Options Screen, select **REMINDER**.
- 3 Using the numbers on the touchscreen, enter the time you want the oven to remind you (be sure the microwave clock shows the correct time of day). Press **ENTER** when finished or **CLEAR** to erase the time you entered.
- 4 Select **AM** or **PM** from the touchscreen. Press **ENTER** when finished or **BACK** to enter a new time.

A rectangular button with a black border and the text "REMINDER" in bold, uppercase letters.

- 5 If the time shown is correct, press **ENTER**.

When Reminder signal occurs, press **OK** to turn it off.

**NOTE:** The **REM** indicator will remain lit to show that the Reminder is set.

### *Setting the Auto Nite Light*

The Auto Nite Light can be set to come on and go off at desired times.

To set the timer:

- 1 From the Home Screen, select **OPTIONS**.
- 2 From the Options Screen, select **AUTO NITE LITE**.
- 3 The display will show the previous time for which the Auto Nite Light was set. If you wish to use that time, press **ENTER**. To set a new time, press **CHANGE TIME**.
- 4 If entering a new time, using the numbers on the touchscreen, enter the time of day for the light to come on. (Be sure the microwave clock shows the correct time of day). Press **ENTER** when finished or **CLEAR** to erase the time you entered.
- 5 Select **AM** or **PM** from the touchscreen. Press **ENTER** when finished or **BACK** to enter a new time.
- 6 Using the numbers on the touchscreen, enter the time of day for the light to go off. Press **ENTER** when finished or **CLEAR** to erase the time you entered.
- 7 Select **AM** or **PM** from the touchscreen. Press **ENTER** when finished or **BACK** to enter a new time.
- 8 The display will show the time for which the Auto Nite Light was set. If you wish to use that time, press **ENTER**. To set a new time, press **CHANGE TIME** and repeat the previous steps.

Press **AUTO NITE LITE** to turn the light on or off and press **ENTER**. If set to **ON**, the light will come on and go off at the times set.

**NOTE:** The **NITE** indicator will remain lit to show that the Auto Nite Light is set.



### *Changing the Beeper Volume*

The beeper sound level can be adjusted.

- 1 From the Home Screen, select **OPTIONS**.
- 2 From the Options Screen, select **BEEPER VOLUME**.
- 3 Using the arrows on the touchscreen, select a volume from mute to loud.
- 4 Press **ENTER** when done or **CANCEL** to keep the current volume.



### *Turntable On/Off*

For best cooking results, leave the turntable on. It can be turned off for large dishes.

- 1 From the Home Screen, select **OPTIONS**.
- 2 From the Options Screen, select **TURNTABLE**.
- 3 Press **TURNTABLE** to turn the turntable on or off.
- 4 Press **ENTER** to save or **CANCEL** to cancel your selection.



**Sometimes the turntable can become too hot to touch.**

Be careful touching the turntable during and after cooking.

### *Changing the Custom Programs*

The **CUSTOM 1** and **CUSTOM 2** pads on the Home Screen can be changed to activate several different microwave programs for one touch recall.

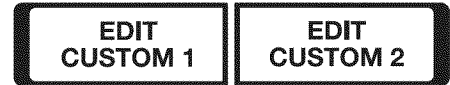

- 1 From the Home Screen, select **OPTIONS**.
- 2 From the Options Screen, select **EDIT CUSTOM 1** if you want to change the selection for **CUSTOM 1**. Select **EDIT CUSTOM 2** if you want to change the selection for **CUSTOM 2**.
- 3 Select a cooking or time feature from the touchscreen. You can find additional features by pressing **MORE** at the bottom of the touchscreen.

The **CUSTOM 1** and **CUSTOM 2** pads on the Home Screen will show the programs you selected for one-touch recall.

### *Setting the Charcoal Filter Reminder*

The Charcoal Filter Reminder is a 180-day timer to remind you when to change the charcoal filter.



- 1 From the Home Screen, select **OPTIONS**.
- 2 From the Options Screen, select **FILTER REMINDER**.

The display will show the number of days remaining until the reminder signals.

- 3 To set the reminder back to 180 days, press **RESET**, then press **ENTER**.

To turn the reminder on or off without changing the countdown time, simply press **ENTER**.

To cancel your entry and return to the Options Screen, press **CANCEL**.

- 4 To turn the reminder on or off, press the **FILTER REMINDER** button on the touchscreen.

- 5 Press **ENTER** to save or press **BACK** to return to the previous screen.

If the Filter Reminder is turned ON, the microwave will signal at the end of the countdown to change the charcoal filter.

### *Changing the Display Options*

Changing the Display Options allows you to turn the clock display on or off, change the color contrast of the touchscreen display or change from standard to metric measurements on the display.

**1** From the Home Screen, select **OPTIONS**.

**2** From the Options Screen, select **DISPLAY OPTIONS**.

**3** To turn the clock display on or off, press **CLOCK** on the touchscreen.

To change the color contrast of the display, press **CONTRAST** until the screen shows the contrast you want.

**4** Press **ENTER** to save your settings or **CANCEL** to cancel your settings.





## Other Features

---

*ge.com*

---

### *Automatic Fan*

An automatic fan feature protects the microwave from too much heat rising from the cooktop below it. It automatically turns on if it senses too much heat.

If you have turned the fan on, you may find that you cannot turn it off. The fan will automatically turn off when the internal parts are cool. It may stay on for 30 minutes or more after the cooktop and microwave controls are turned off.

---

### *Vent Fan*

The vent fan removes steam and other vapors from surface cooking.

Press **VENT** once for high fan speed, twice for medium fan speed, a third time for low fan speed or a fourth time to turn the fan off.

Press the **BOOST** pad for extra fan speed.

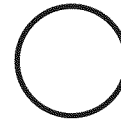

**VENT**

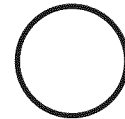

**BOOST**

---

### *Surface Light*

Press **LIGHT** once for bright light, twice for the night light or three times to turn the light off.

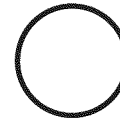

**LIGHT**

---

### *Off*

Pressing **OFF** while on the Home Screen will put the touchscreen display into standby mode, and the display will be dark. Press the touchscreen or **HOME**, or open the door to “wake up” the display.

Pressing **OFF** while cooking will cancel the current program and returns the display to the Home Screen.

**NOTE:** Pressing **OFF** does not disconnect the appliance from the power supply.



**OFF**

---

### *Child Lockout*

You may lock the control panel to prevent the microwave from being accidentally started or used by children.

To lock or unlock the controls, press and hold **OFF** for about three seconds. When the control panel is locked, **CONTROL IS LOCKED** will be displayed.



**OFF**

## About the Help Feature

Pressing **HELP** from the Home Screen allows you to locate feature information and helpful hints. After pressing **HELP**:

- Press **PRODUCT DETAILS** to find information concerning your model and serial number.
- Press **FEATURE HELP** to find help locating information on microwave features.
- Press **SAFETY GUIDE** to find help locating microwave safety information.
- Press **TROUBLESHOOTER** to find troubleshooting tips for common microwave problems.
- Press **SPACEMAKER 2.0 OVERVIEW** to find an overview of the features of your microwave.

### SELECT HELP FUNCTION

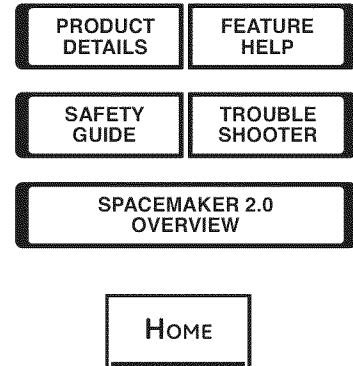

## Feature Help

Pressing the **HELP** pad while on any screen other than the Home Screen allows you to find additional information on features found on that screen.

Press **HELP**, then touch any pad on the Touch Screen for an explanation of that feature.

## Using the Troubleshooter

To locate Troubleshooting Tips for common microwave problems:

- 1 Press the **HELP** button from the Home Screen.
- 2 Select **TROUBLESHOOTER** from the touchscreen.
- 3 Select the problem description from the list on the touchscreen. You can find additional problems by pressing **MORE** at the bottom of the touchscreen, or press **BACK** to return to the previous screen.

*Shelf*

Food microwaves best when placed on the turntable or on the shelf in the lower position.

Only use the shelf when reheating on more than one level. Do not store the shelf inside the oven cavity.

- Make sure the shelf is positioned properly inside the microwave to prevent damage to the oven from arcing.
- Do not use a microwave browning dish on the shelf. The shelf could overheat.
- Do not use the oven with the shelf on the microwave floor. This could damage the microwave.
- Use pot holders when handling the shelf—it may be hot.
- Do not use the shelf when cooking popcorn.
- Do not use the shelf with Sensor Cooking or Reheat.

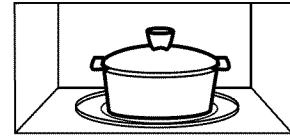

*For best results*

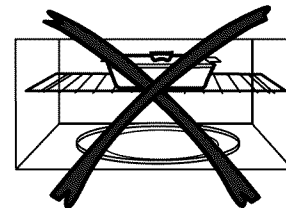
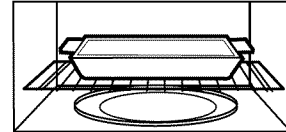

*Uneven results*

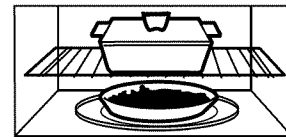

*2-level reheating*

*Shelf and Reheating*

**To reheat on 2 levels OR  
To reheat 2 dishes on the lower level:**

- 1 Multiply reheat time by 1-1/2.
- 2 Switch places after 1/2 the time.

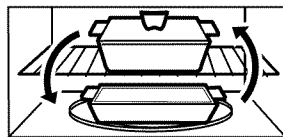

*Switch places after 1/2 time*

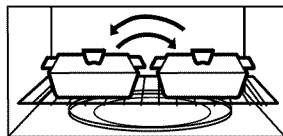

*Switch places after 1/2 time*

**To reheat on 3 levels:**

- 1 Turn the turntable off.
- 2 Double the reheating time.
- 3 Switch places twice and give the dishes a 1/2 turn during reheating. (Place dense foods, or those that require a longer cook time, on the upper shelf first.)

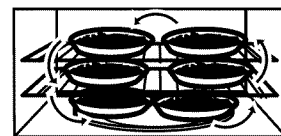

*Switch places twice*

## Microwave Terms

*ge.com*

<b>Term</b>	<b>Definition</b>
<b>Arcing</b>	Arcing is the microwave term for sparks in the oven. Arcing is caused by: <ul style="list-style-type: none"><li>• the metal shelf being installed incorrectly and touching the microwave walls.</li><li>• metal or foil touching the side of the oven.</li><li>• foil that is not molded to food (upturned edges act like antennas).</li><li>• metal such as twist-ties, poultry pins, gold-rimmed dishes.</li><li>• recycled paper towels containing small metal pieces.</li></ul>
<b>Covering</b>	Covers hold in moisture, allow for more even heating and reduce cooking time. Venting plastic wrap or covering with wax paper allows excess steam to escape.
<b>Shielding</b>	In a regular oven, you shield chicken breasts or baked foods to prevent over-browning. When microwaving, you use small strips of foil to shield thin parts, such as the tips of wings and legs on poultry, which would cook before larger parts.
<b>Standing Time</b>	When you cook with regular ovens, foods such as roasts or cakes are allowed to stand to finish cooking or to set. Standing time is especially important in microwave cooking. Note that a microwaved cake is not placed on a cooling rack.
<b>Venting</b>	After covering a dish with plastic wrap, you vent the plastic wrap by turning back one corner so excess steam can escape.

### *Helpful Hints*

An occasional thorough wiping with a solution of baking soda and water keeps the inside fresh.

**Be certain the oven control is turned off before cleaning any part of this oven.**



### *How to Clean the Inside*

#### ***Walls, Floor, Inside Window, Metal and Plastic Parts on the Door***

Some spatters can be removed with a paper towel; others may require a damp cloth. Remove greasy spatters with a sudsy cloth, then rinse with a damp cloth. Do not use abrasive cleaners or sharp utensils on oven walls.

**Never use a commercial oven cleaner on any part of your microwave.**

#### ***Removable Turntable and Turntable Support***

To prevent breakage, do not place the turntable into water just after cooking. Wash it carefully in warm, sudsy water or in the dishwasher. The turntable and support can be broken if dropped. Remember, do not operate the oven without the turntable and support in place.

#### ***Shelf***

Clean with mild soap and water or in the dishwasher.

Do not clean in a self-cleaning oven.

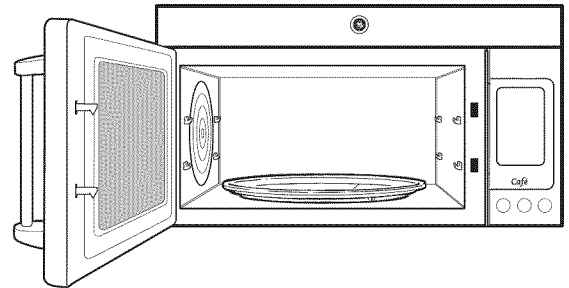

### Helpful Hints

We recommend against using cleaners with ammonia or alcohol, as they can damage the appearance of the microwave oven. If you choose to use a common household cleaner, first apply the cleaner directly to a clean cloth, then wipe the soiled area.

#### Case

Clean the outside of the microwave with a sudsy cloth. Rinse and then dry. Wipe the window clean with a damp cloth.

#### Control Panel

Wipe with a damp cloth. Dry thoroughly. Do not use cleaning sprays, large amounts of soap and water, abrasives or sharp objects on the panel—they can damage it. Some paper towels can also scratch the control panel.

#### Door Panel

Before cleaning the front door panel, make sure you know what type of panel you have. Refer to the eighth digit of the model number. “S” is stainless steel, “L” is CleanSteel and “B”, “W” or “C” are plastic colors.

#### Stainless Steel

The stainless steel panel can be cleaned with Stainless Steel Magic or a similar product using a clean, soft cloth. Apply stainless cleaner carefully to avoid the surrounding plastic parts. Do not use appliance wax, polish, bleach or products containing chlorine on Stainless Steel finishes.

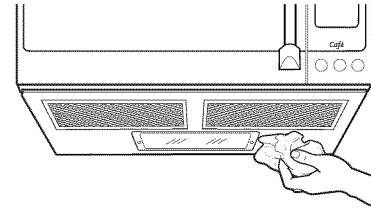

#### CleanSteel

Use a clean, soft, light and lightly dampened cloth, then dry thoroughly. Do not use appliance wax, polish, bleach or products containing any chemical agent on the CleanSteel surfaces.

#### Plastic Color Panels

Use a clean, soft, lightly dampened cloth, then dry thoroughly.

#### Door Seal

It's important to keep the area clean where the door seals against the microwave. Use only mild, non-abrasive detergents applied with a clean sponge or soft cloth. Rinse well.

#### Bottom

Clean off the grease and dust on the bottom often. Use a solution of warm water and detergent.

### Vent Fan

The vent fan has 2 metal reusable grease filters.

Models that recirculate air back into the room also use a charcoal filter.

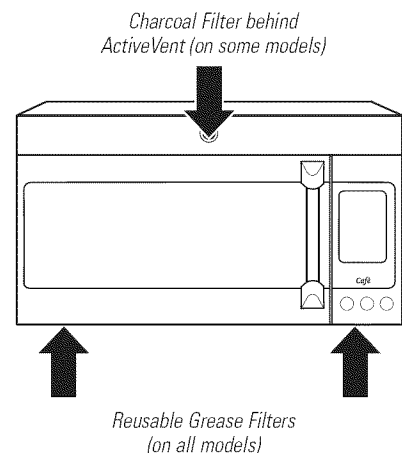

### Reusable Grease Filters

The metal filters trap grease released by foods on the cooktop. They also prevent flames from foods on the cooktop from damaging the inside of the microwave.

For this reason, the filters must ALWAYS be in place when the hood is used. The grease filters should be cleaned once a month, or as needed.

### Removing and Cleaning the Filter

**To remove**, slide it to the outside using the tab. Pull it down and out.

**To clean the grease filter**, soak it and then swish it around in hot water and detergent. Don't use ammonia or ammonia products because they will darken the metal. Light brushing can be used to remove embedded dirt.

Rinse, shake and let it dry before replacing.

**To replace**, slide the filter in the frame slot at the outside of the opening. Pull up and in to lock into place.

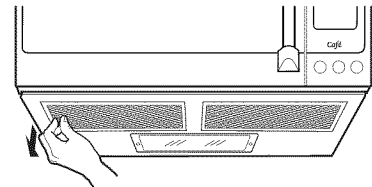

### Charcoal Filter (on some models)

**The charcoal filter cannot be cleaned. It must be replaced. Order Part No. WB2X10956 from your GE supplier.**

If the model is not vented to the outside, the air will be recirculated through a disposable charcoal filter that helps remove smoke and odors.

The charcoal filter should be replaced when it is noticeably dirty or discolored (usually after 6 to 12 months, depending on hood usage). See "Optional Kits", page 7, for more information.

### Replacing the Charcoal Filter

#### To remove the charcoal filter:

- 1 Disconnect power at the main fuse or circuit breaker panel or pull the plug.
- 2 Remove the top grille by removing the screws on top of the grille that hold it in place and sliding the grille to the left (opening the door makes grille removal easier).
- 3 Slide the filter toward the front of the oven and remove it.

#### To install a new filter:

- 1 Remove plastic and other outer wrapping from the new filter.
- 2 Insert the filter into the top opening of the oven as shown. It will rest at an angle on 2 side support tabs and in front of the right rear tab.
- 3 Replace the grille and screws.

Remove grille screws to remove the grille

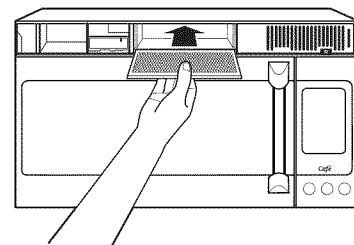
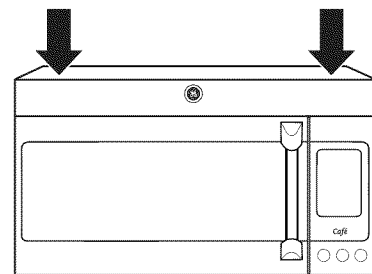

### *Cooktop Light/ Night Light*

**Replace the burned-out bulb with a 120 volt, 20-watt halogen bulb (WB36X10213), available from your GE supplier.**

- 1 To replace the bulb(s), first disconnect the power at the main fuse or circuit breaker panel or pull the plug.
- 2 Remove the screw at the right edge of the light cover and push on the left edge of the cover to open.
- 3 Be sure the bulb(s) to be replaced are cool before removing. After breaking the adhesive seal, remove the bulb by pulling straight out. Replace with the same size and type bulb.
- 4 Raise the light shield and replace the screw. Connect electrical power to the oven.

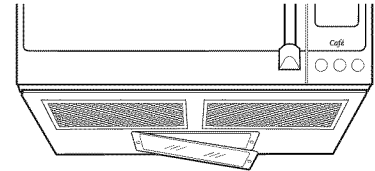
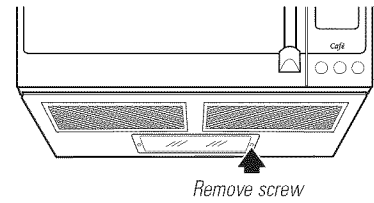

### *Oven Light*

**Replace the burned-out bulb with a 120 volt, 20-watt halogen bulb (WB36X10213), available from your GE supplier.**

- 1 To replace the oven light, first disconnect the power at the main fuse or circuit breaker panel or pull the plug.
- 2 Remove the top grille by taking out the screws on top of the grille that hold it in place and sliding the grille to the left (opening the door makes grille removal easier).
- 3 Lift off the light cover at the left of the top opening.
- 4 Pinch the clips that hold the light socket in place and lift the socket out.
- 5 Remove the bulb from the light socket by pulling straight out. Replace with the same size and type bulb, then replace the light socket and cover.
- 6 Replace the grille and screws. Connect electrical power to the oven.

Remove grille screws to remove the grille

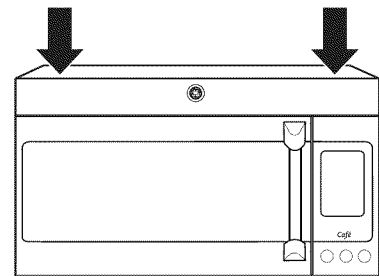

Light Cover

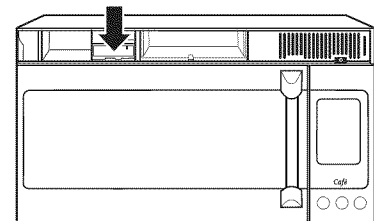



**For a complete list of solutions to common microwaving problems, use the Troubleshooting Tips feature located by pressing the HELP button while on the microwave Home Screen (see *Using the Troubleshooter*).**

**If your microwave will not operate, check the Problem Solver below:**

Problem	Possible Cause	What To Do
<b>Oven will not start</b>	Control panel is asleep	<ul style="list-style-type: none"> <li>This is normal. Press <b>HOME</b> or the touchscreen to activate the control panel.</li> </ul>
	A fuse in your home may be blown or the circuit breaker tripped	<ul style="list-style-type: none"> <li>Replace fuse or reset circuit breaker.</li> </ul>
	Power surge	<ul style="list-style-type: none"> <li>Unplug the microwave oven, then plug it back in.</li> </ul>
	Controls are not set properly	<ul style="list-style-type: none"> <li>Check controls.</li> </ul>
	Plug not fully inserted into	<ul style="list-style-type: none"> <li>Make sure the 3-prong plug on the oven is fully wall outlet inserted into wall outlet.</li> </ul>
	Door is not closed	<ul style="list-style-type: none"> <li>Open and close the door securely.</li> </ul>
	<b>START</b> was not pressed	<ul style="list-style-type: none"> <li>Press <b>START</b>.</li> </ul>
<b>“CONTROL IS LOCKED” appears on the display</b>	The control has been locked	<ul style="list-style-type: none"> <li>Press and hold <b>OFF</b> for about 3 seconds to unlock the control.</li> </ul>

*Things That Are Normal With Your Microwave Oven*

- Steam or vapor escaping from around the door.
- Light reflection around door or outer case.
- Dimming oven light and change in the blower sound at power levels other than high.
- Moisture on the oven door and walls while cooking. Wipe the moisture off with a paper towel or soft cloth.
- Moisture between the oven door panels when cooking certain foods. Moisture should dissipate shortly after cooking is finished.
- Dull thumping sound while oven is operating.
- TV/radio interference might be noticed while using the microwave. Similar to the interference caused by other small appliances, it does not indicate a problem with the microwave. Plug the microwave into a different electrical circuit, move the radio or TV as far away from the microwave as possible, or check the position and signal of the TV/radio antenna.
- The Active Vent door (on some models) will open during operation, and remain open while the microwave is running, to keep the electronics cool. It is also normal to hear a clicking noise as the vent door opens and closes.

# Microwave Oven Warranty

ge.com

All warranty service provided by our Factory Service Centers or an authorized Customer Care<sup>®</sup> technician. To schedule service, on-line visit us at ge.com or call 800.GE.CARES (800.432.2737). Please have serial and model numbers available when calling for service.

Staple your receipt here. Proof of the original purchase date is needed to obtain service under the warranty.

For The Period Of:	GE Will Replace:
<b>One Year</b> From the date of the original purchase	Any <i>part</i> of the microwave oven which fails due to a defect in materials or workmanship. During this <i>limited one-year warranty</i> , GE will also provide, <i>free of charge</i> , all labor and related service costs to replace the defective part.
<b>Five Years</b> From the date of the original purchase	The <i>magnetron tube</i> , if the magnetron tube fails due to a defect in materials or workmanship. During this <i>five-year limited warranty</i> , you will be responsible for any labor or related service costs.

## What Is Not Covered:

- Service trips to your home to teach you how to use the product.
- Improper installation, delivery or maintenance.
- Product not accessible to provide required service.
- Failure of the product or damage to the product if it is abused, misused (for example, cavity arcing from wire rack or metal/foil), or used for other than the intended purpose or used commercially.
- Replacement of the cooktop light bulb.
- Replacement of house fuses or resetting of circuit breakers.
- Damage to the product caused by accident, fire, floods or acts of God.
- Incidental or consequential damage caused by possible defects with this appliance.
- Damage caused after delivery.

**EXCLUSION OF IMPLIED WARRANTIES**—Your sole and exclusive remedy is product repair as provided in this Limited Warranty. Any implied warranties, including the implied warranties of merchantability or fitness for a particular purpose, are limited to one year or the shortest period allowed by law.

This warranty is extended to the original purchaser and any succeeding owner for products purchased for home use within the USA. If the product is located in an area where service by a GE Authorized Servicer is not available, you may be responsible for a trip charge or you may be required to bring the product to an Authorized GE Service Location for service. In Alaska, the warranty excludes the service calls to your home.

Some states do not allow the exclusion or limitation of incidental or consequential damages. This warranty gives you specific legal rights, and you may also have other rights which vary from state to state. To know what your legal rights are, consult your local or state consumer affairs office or your state's Attorney General.

**Warrantor: General Electric Company, Louisville, KY 40225**



## *GE Appliances Website*

*ge.com*

Have a question or need assistance with your appliance? Try the GE Appliances Web site 24 hours a day, any day of the year! For greater convenience and faster service, you can now download Owner's Manuals, order parts or even schedule service on-line.

## *Schedule Service*

*ge.com*

Expert GE repair service is only one step away from your door. Get on-line and schedule your service at your convenience any day of the year! Or call 800.GE.CARES (800.432.2737) during normal business hours.

## *Real Life Design Studio*

*ge.com*

GE supports the Universal Design concept—products, services, and environments that can be used by people of all ages, sizes, and capabilities. We recognize the need to design for a wide range of physical and mental abilities and impairments. For details of GE's Universal Design applications, including kitchen design ideas for people with disabilities, check out our Web site today. For the hearing impaired, please call 800.TDD.GEAC (800.833.4322).

## *Extended Warranties*

*ge.com*

Purchase a GE extended warranty and learn about special discounts that are available while your warranty is still in effect. You can purchase it on-line anytime or call 800.626.2224 during normal business hours. GE Consumer Home Services will still be there after your warranty expires.

## *Parts and Accessories*

*ge.com*

Individuals qualified to service their own appliances can have parts or accessories sent directly to their homes (VISA, MasterCard, and Discover cards are accepted). Order on-line today, 24 hours every day, or by phone at 800.626.2002 during normal business hours.

***Instructions contained in this manual cover procedures to be performed by any user. Other servicing generally should be referred to qualified service personnel. Caution must be exercised, since improper servicing may cause unsafe operation.***

## *Contact Us*

*ge.com*

If you are not satisfied with the service you receive from GE, contact us on our Web site with all the details, including your phone number, or write to: General Manager, Customer Relations  
GE Appliances, Appliance Park  
Louisville, KY 40225

## *Register Your Appliance*

*ge.com*

Register your new appliance on-line—at your convenience! Timely product registration will allow for enhanced communication and prompt service under the terms of your warranty, should the need arise. You may also mail in the preprinted registration card included in the packing material.