

Use and Care Guide



NOTE: Use and care instructions for the upper oven are provided in a separate manual.

KitchenAid[®]

Table of Contents (complete)	2
A Note to You	2
Oven Safety	3-4
Parts and Features	5
Using Your Oven	6
Using EASY CONVECT* Conversion	26
Caring for Your Oven	40
Using the Self-Cleaning Cycle	44
Troubleshooting	49
Requesting Assistance or Service	51
Index	55
Warranty	56

In the U.S.A. for assistance or service,
call the Consumer Assistance Center:

1-800-422-1230

In Canada for assistance
or service, see page 52.

KITCHENAID[®] Electric Combination THERMAL-CONVECTION* Lower Oven

Table of Contents

A Note to You	2	Broiling tips	32
Oven Safety	3-4	Timed cooking	33
Parts and Features	5	Dehydrating	37
Using Your Oven	6	Raising (proofing) bread	39
Using the electronic oven control	6	The oven vent	39
Oven settings	10	Caring for Your Oven	40
Setting the clock	12	Cleaning your oven and controls	40
Using the timer	13	Removing the oven door	42
Baking or convection baking	14	Using and replacing the oven lights ...	43
Convection roasting	16	Using the Self-Cleaning Cycle	44
Cooking tips	17	Before you start	44
Adjusting oven temperature	19	Before setting the controls	45
Using the temperature probe	20	Setting the controls	45
Using CONVECT FULL MEAL	23	For best cleaning results	47
Using EASY CONVECT*		How the cycle works	48
Conversion	26	Troubleshooting	49
Broiling	28	Requesting Assistance or Service	51
Convection broiling	31	Index	55
		Warranty	56

A Note to You

Thank you for buying a KITCHENAID* appliance!

KitchenAid designs the best tools for the most important room in your house. To ensure that you enjoy many years of trouble-free operation, we developed this Use and Care Guide. It contains valuable information concerning how to operate and maintain your new appliance properly and safely. Please read it carefully. Also, please complete and mail the enclosed Product Registration Card.

Please record your model's information.

If you need assistance or service, first see the "Troubleshooting" section of this book. After checking "Troubleshooting," additional help can be found by checking the "Requesting Assistance or Service" section.

When calling, you will need to know your appliance's complete model number and serial number. You can find this information on the model and serial number plate (see diagram in the "Parts and Features" section).

Keep this book and the sales slip together in a safe place for future reference. **You must provide proof of purchase or installation date for in-warranty service.**

Model Number _____

Serial Number _____

**Purchase/
Installation Date** _____

**Builder/Dealer
Name** _____

Address _____

Phone _____

Oven Safety

Your safety and the safety of others is very important.

We have provided many important safety messages in this manual and on your appliance. Always read and obey all safety messages.



This is the safety alert symbol.

This symbol alerts you to hazards that can kill or hurt you and others.

All safety messages will be preceded by the safety alert symbol and the word "DANGER" or "WARNING." These words mean:

⚠ DANGER

You will be killed or seriously injured if you don't follow instructions.

⚠ WARNING

You can be killed or seriously injured if you don't follow instructions.

All safety messages will identify the hazard, tell you how to reduce the chance of injury, and tell you what can happen if the instructions are not followed.

IMPORTANT SAFETY INSTRUCTIONS

WARNING: To reduce the risk of fire, electrical shock, injury to persons, or damage when using the oven, follow basic precautions, including the following:

- Proper Installation – Be sure the oven is properly installed and grounded by a qualified technician.
- Never Use the Oven for Warming or Heating the Room.
- Do Not Leave Children Alone – Children should not be left alone or unattended in area where oven is in use. They should never be allowed to sit or stand on any part of the oven.
- Wear Proper Apparel – Loose-fitting or hanging garments should never be worn while using the oven.
- User Servicing – Do not repair or replace any part of the oven unless specifically recommended in the manual. All other servicing should be referred to a qualified technician.
- Storage in Oven – Flammable materials should not be stored in an oven.
- Do Not Use Water on Grease Fires – Smother fire or flame or use dry chemical or foam-type extinguisher.
- Use Only Dry Potholders – Moist or damp potholders on hot surfaces may result in burns from steam. Do not let potholder touch hot heating elements. Do not use a towel or other bulky cloth.

continued on next page

Oven Safety

- **Use Care When Opening Door**
– Let hot air or steam escape before removing or replacing food.
- **Do Not Heat Unopened Food Containers** – Build-up of pressure may cause container to burst and result in injury.
- **Keep Oven Vent Ducts Unobstructed.**
- **Placement of Oven Racks** – Always place oven racks in desired location while oven is cool. If rack must be moved while oven is hot, do not let potholder contact hot heating element in oven.
- **DO NOT TOUCH HEATING ELEMENTS OR INTERIOR SURFACES OF OVEN** – Heating elements may be hot even though they are dark in color. Interior surfaces of an oven become hot enough to cause burns. During and after use, do not touch, or let clothing or other flammable materials contact heating elements or interior surfaces of oven until they have had sufficient time to cool. Other surfaces of the oven may become hot enough to cause burns – among these surfaces are oven vent openings and surfaces near these openings, oven doors, and windows of oven doors.
- **Do Not Clean Door Gasket** – The door gasket is essential for a good seal. Care should be taken not to rub, damage, or move the gasket.
- **Do Not Use Oven Cleaners** – No commercial oven cleaner or oven liner protective coating of any kind should be used in or around any part of the oven.
- **Clean Only Parts Listed in Manual.**
- **Before Self-Cleaning the Oven** – Remove broiler pan and other utensils.

– SAVE THESE INSTRUCTIONS –

Parts and Features

This section tells you what features your oven has and where they are located. Please review this information before using your oven. To help you find information on specific parts or features quickly, page references are included.

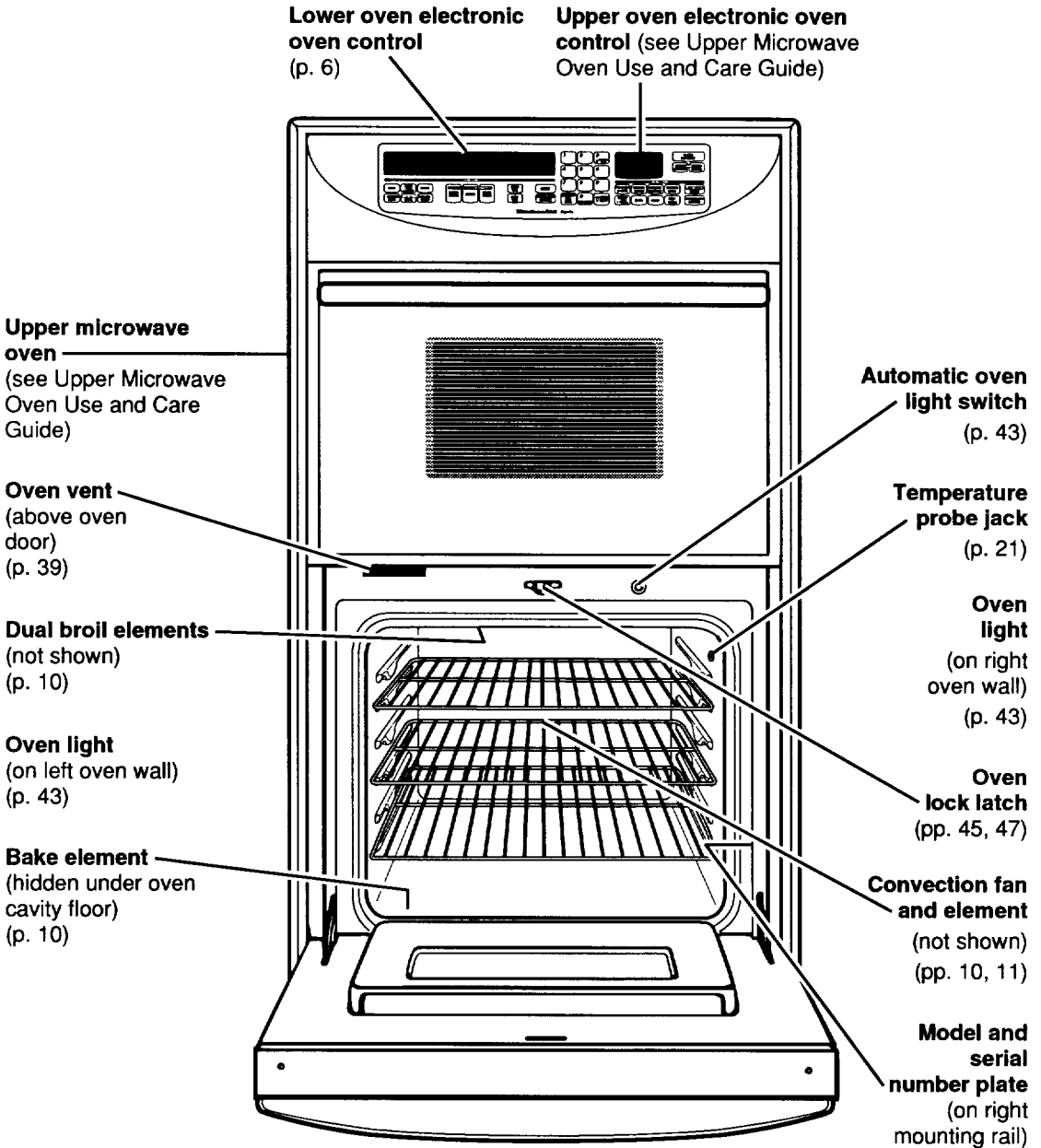

Using Your Oven

This section tells you, step by step, how to operate all oven functions controlled by the electronic control. Carefully follow these instructions, along with the cooking tips, for successful use of your oven.

Using the electronic oven control

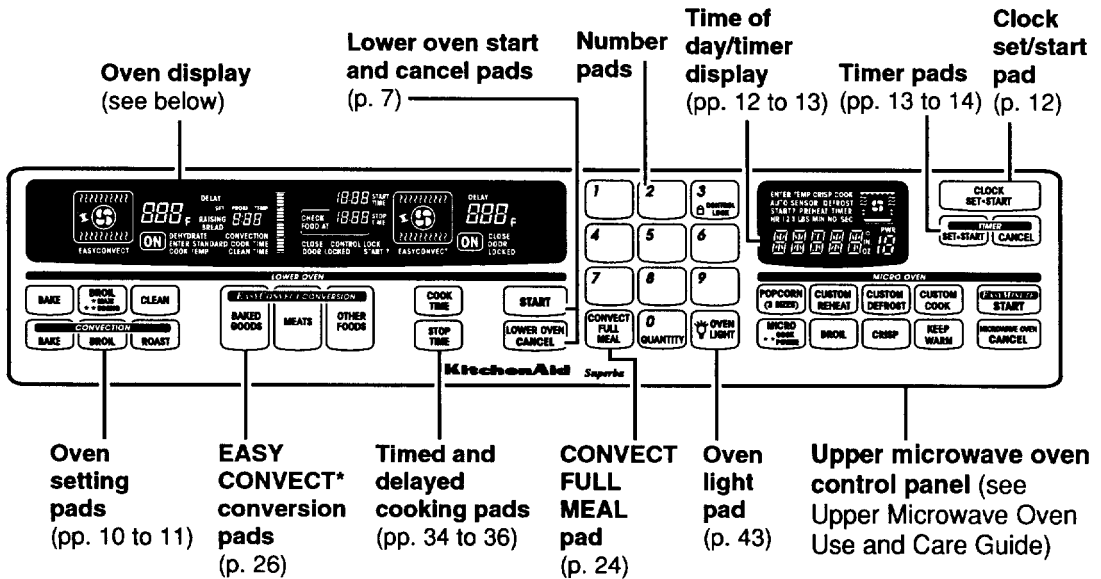

Display/clock

- **When you first plug in** the oven, both displays will be fully lit for a few seconds. Then the microwave oven display will show the set time and the lower oven display will show "PF" (power failure).
- **If you make an incorrect entry**, you will hear the following:
 - For clock entry, you will hear one short tone and see "CLOCK" on the display.
 - For Timer entry, you will hear three short tones.
 - For cook time entry, you will hear three short tones and see "Err" on the display.
 - For stop time entry, you will hear three short tones and see "Err" on the display.
 - For temperature entry, you will hear three short tones and see "Err" on the display.
 - For meat probe temperature entry, you will hear three short tones and see "Err" on the display.

Celsius/Fahrenheit

To set your oven to cook in Celsius instead of Fahrenheit:

PRESS and hold for 5 seconds



You will know you are in Celsius when "F" disappears. To switch back to Fahrenheit, press and hold BROIL again for 5 seconds. ("F" will reappear.)

If you need to convert temperatures from Celsius to Fahrenheit or vice versa, you can refer to this chart:

Temperature replacement values

38°C to 100°F	163°C to 325°F
60°C to 140°F	177°C to 350°F
66°C to 150°F	191°C to 375°F
77°C to 170°F	204°C to 400°F
93°C to 200°F	218°C to 425°F
121°C to 250°F	232°C to 450°F
135°C to 275°F	246°C to 475°F
149°C to 300°F	260°C to 500°F

Using Your Oven

Starting an operation

After programming a function, you must press the Start pad to start the function. If you do not press the Start pad within 5 seconds of programming, "START?" will show on the display as a reminder.



START

Canceling an operation

Lower Oven Cancel pad will cancel any lower oven function. When you press the Lower Oven Cancel pad, the large display will not show anything, unless the oven is too hot after canceling a Self-Cleaning cycle.

NOTE: You may hear a fan blowing in the oven after you press the Lower Oven Cancel pad. This is the cooling fan. It will turn off when the oven has cooled down.

Changing audible signals

Audible signals tell you if a function is entered correctly or not. They also tell you when a cycle is completed.

To change pitch and loudness of key tone:
PRESS and hold for 5 seconds



7

A short tone will sound and "Snd" and "Hi" or "Lo" will appear on the display. Repeat the step above to change to the other setting.

To turn on and off oven reminder tones:

PRESS and hold for 5 seconds



COOK
TIME

To turn on and off timer reminder tones:
PRESS and hold for 5 seconds



TIMER
SET-START

To turn on and off key pad entry and end-of-cycle tones:

PRESS and hold for 5 seconds



STOP
TIME

A short tone will sound and "Snd" and "ON" or "OFF" will appear on the display to tell you the signals have been changed. Repeat the step above to turn the signals back on.

Using the control lock

The control lock prevents unwanted use of the oven by disabling the control panel command pads.

NOTES:

- **Control lock** is available only when both the lower oven and the microwave oven are not in use. It is also not available during the Self-Cleaning cycle or the Sabbath mode.
- **Control lock** does not disable the Timer or Clock.
- **Set control lock** when cleaning the control panel to prevent oven from accidentally turning on.

To lock or deactivate the control panel:

Press and hold the Control Lock pad (Number Pad 3) for 5 seconds. A single tone will sound and "CONTROL LOCK 

To unlock the control panel:

Press and hold the Control Lock pad (Number Pad 3) for 5 seconds. A single tone will sound after 5 seconds and "CONTROL LOCK 

Prompt for start

If "START?" is lit, this means that the Start pad has not been pressed. If you do not press the Start pad, the programmed function will automatically be canceled in 5 minutes.

continued on next page

Using Your Oven

Setting your oven for the Sabbath†

If you want to set your oven to meet “no work” requirements for the Sabbath, follow these steps:

1. Press **BAKE**.



2. Press Number Pads to set the temperature you want.



(example for 325°F [160°C])

3. Press **START**.



4. Press and hold Number Pad 6 for 5 seconds to go into the Sabbath mode.



† Star K certification pending. Full certification by Star K is expected near the end of 1996 or early 1997. Information is accurate as of 4/97.

NOTE: The Sabbath mode is only available with the Bake function. Before going into the Sabbath mode make sure the timer is off. Also, make sure you are in an untimed Bake mode with no cook time or stop time specified.

What your oven will/will not do while in the Sabbath mode:

- **The oven** will not shut off automatically.
- **The temperature display** of the lower oven will show “Sab.”
- **To prevent accidental key pad presses**, only the 0 to 9 and Start key pads will work.
- **No tones** will sound.
- **No error messages** or temperature changes will be displayed.
- **The ON indicator** remains lighted.
- **Heating element** icons flash before oven heating elements turn on or turn off.
- **With the oven door closed**, heating element icons light when the oven is heating and go off when the oven stops heating.

NOTE: If you open the oven door when the elements are off, the elements will not turn on. Elements will not turn on immediately after the door is closed. If you open the oven door when the elements are on, the elements will turn off after a delay. Again, elements will not turn on immediately after the door is closed.

Using Your Oven

To change the temperature during the Sabbath mode for holidays:

1. **Press** a Number Pad for the desired temperature. Each Number Pad is programmed for a specific set temperature:

NUMBER PAD	SET TEMPERATURE
1	170°F (75°C)
2	200°F (95°C)
3	250°F (120°C)
4	300°F (150°C)
5	325°F (160°C)
6	350°F (175°C)
7	375°F (190°C)
8	400°F (205°C)
9	475°F (245°C)

2. **Press and hold** the START pad for 1 second.



NOTES:

- **It may take the oven** up to one half hour to reach the desired temperature.
- **Changing the temperature** will not turn the heating elements on or off immediately. Also, the display will not show the temperature change immediately.

To end the Sabbath mode and turn off oven:

- **Press and hold** Number Pad 6 for 5 seconds.



If a power failure occurs during the Sabbath mode:

The oven will automatically return to the Sabbath mode at the desired temperature when power returns.

Using Your Oven

Oven settings

This chart tells you when to use each setting. It also explains which elements heat up for each setting.

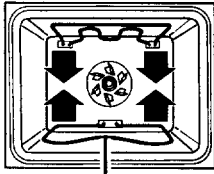
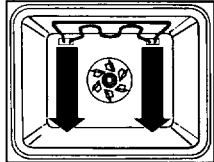
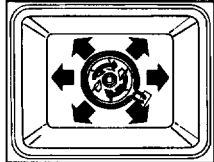
SETTING	DIAGRAM	SETTING INFORMATION
BAKE Use this setting for standard baking and roasting.	 Bake element (not visible)	<ul style="list-style-type: none">• The bottom element and both top elements heat up.• The elements will turn on and off to maintain the oven temperature.• Opening the door during Bake will cause the broil elements to turn off immediately and the bake element to turn off after 2 minutes.
BROIL (MAXI/ECONO) Use Maxi Broil setting for food that covers most or all of the broiler grid. Use Econo Broil setting for food that covers only the center of the broiler grid.		<ul style="list-style-type: none">• Both top elements heat during Maxi Broil. (Maximum browning coverage.)• Only the inner element heats up during Econo Broil. (Browning coverage in center only.)• The elements will turn on and off to maintain the oven temperature.• Opening the door during Broil will cause the broil elements to turn off immediately.
CONVECTION BAKE Use this setting for delicate foods and for baking breads and cakes. Use also when baking large quantities of food on more than one oven rack.		<ul style="list-style-type: none">• For faster preheating, both top (and in some models also the bottom) elements heat up until oven reaches desired temperature. After preheat, only the rear element heats up (and in some models the bottom element heats up).• For even heating, the fan at the back of the oven circulates air in the oven cavity.• The elements will turn on and off to maintain the oven temperature.• Opening the door during Convection Bake will cause the broil elements, convection fan, and rear element to turn off immediately. The bake element will turn off after 2 minutes.

Using Your Oven

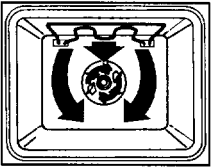
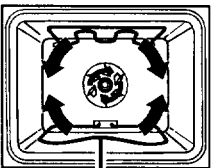
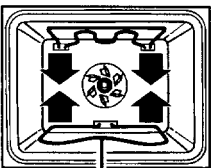
SETTING	DIAGRAM	SETTING INFORMATION
<p>CONVECTION BROIL Use this setting for broiling thick cuts of meat.</p>		<ul style="list-style-type: none">• Both top elements heat up.• For even heating, the fan at the back of the oven circulates air in the oven cavity.• The elements will turn on and off to maintain the oven temperature.• Opening the door during Convection Broil will cause the broil elements and convection fan to turn off immediately.
<p>CONVECTION ROAST Use this setting for roasting and baking on one rack.</p>	 <p>Bake element (not visible)</p>	<ul style="list-style-type: none">• The bottom element and both top elements heat up.• For even heating and faster cooking, the fan at the back of the oven circulates air in the oven cavity.• The elements will turn on and off to maintain the oven temperature.• Opening the door during Convection Roast will cause the broil elements and convection fan to turn off immediately. The bake element will turn off after 2 minutes.
<p>CLEAN Use this setting for self-cleaning only.</p>	 <p>Bake element (not visible)</p>	<ul style="list-style-type: none">• The bottom element and both top elements heat up.

Using Your Oven

Setting the clock

NOTE: You can only set the clock when the lower oven and the microwave oven are not cooking food and when the timer is not counting down.

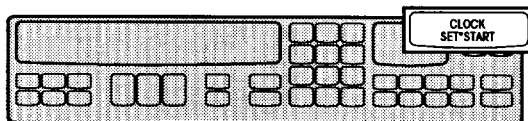

1. Press Clock Set/Start pad.

PRESS



YOU SEE



2. Set time.

Example for 5:30:

PRESS



YOU SEE



3. Start clock.

If time has not been entered correctly, one short tone will sound and "CLOCK" will reappear on the display. Repeat Steps 2 and 3 to re-enter the time of day.

PRESS



OR



YOU SEE

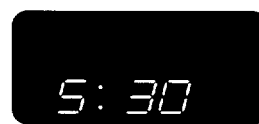

To disable the display clock:

You can clear the time of day from the display by pressing and holding CLOCK SET/START for 5 seconds. Repeat to see time of day on display again.

Using the timer

The Timer does not start or stop the oven. It works like a regular kitchen timer. It can be set in hours and minutes up to 99 hours, 59 minutes or in minutes and seconds up to 99 minutes, 59 seconds.

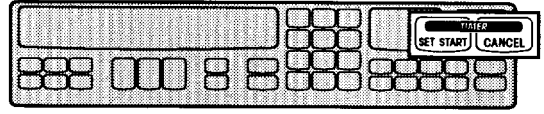

1. Press Timer Set/Start pad.

- **Once** to set minutes and seconds
- **Twice** to set hours and minutes

PRESS



YOU SEE

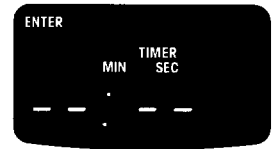

OR

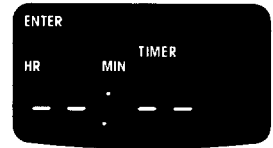

2. Enter time to be counted down.

Example for 10 minutes:

PRESS

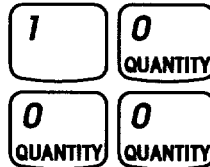

YOU SEE



3. Start countdown.

The Timer will begin counting down immediately after you press the Timer Set/Start pad or Start pad.

PRESS



YOU SEE



(display shows time counting down)

4. When time is up, turn off Timer.

When time is up, you will hear four tones unless end of cycle tone is disabled. (See "Changing audible signals" in the "Using the electronic oven control" section.) Press the Timer Cancel pad to clear the display. Also, four tones will sound every minute as an audible reminder unless they are disabled. (See "Changing audible signals" in the "Using the electronic oven control" section.)

YOU SEE



Using Your Oven

To change the timer during its operation:

1. **Press** Timer Set/Start pad.
2. **Enter** new desired time.
3. **Press** Timer Set/Start pad.

To cancel the timer during its operation:

You can cancel the Timer any time during its operation. Press the Timer Cancel pad.

PRESS



YOU SEE



(time of day)

Baking or convection baking

NOTE: If you need to convert temperatures from Celsius to Fahrenheit or vice versa, see "Celsius/Fahrenheit" in the "Using the electronic oven control" section.

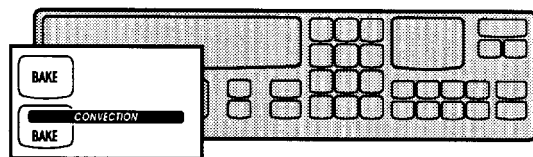

1. Position racks.

For correct rack placement, see the "Rack placement" chart in the "Cooking tips" section.

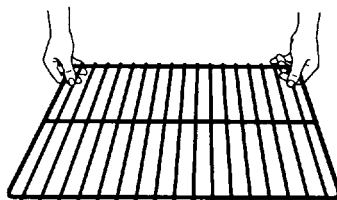

Your lower oven has either 2 or 3 racks and 5 rack positions. Rack position 5 is the highest position, or farthest from the bottom of the oven. Rack position 1 is the lowest position, or closest to the bottom of the oven.

NOTES:

- **Before turning oven on**, position oven rack(s) in desired location.
- **Be sure** the rack(s) is level.
- **Use pot holders or oven mitts** to protect hands if rack(s) must be moved while oven is hot.
- **Do not let** pot holder or oven mitt touch oven bottom.

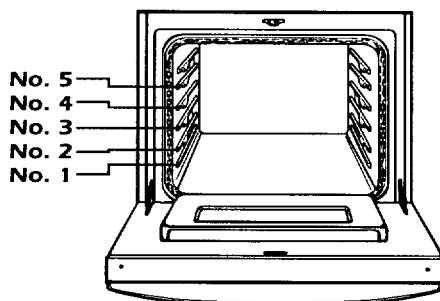

Using Your Oven

2. Choose baking setting.

PRESS



OR

PRESS



YOU SEE

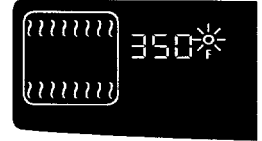

(or 175°C)

YOU SEE



(or 150°C)

3. Set temperature (optional).

Do this step if you want to set a temperature other than 350°F (175°C) for Bake or 300°F (150°C) for Convection Bake.

NOTE: See a reliable cookbook or your convection oven cookbook for temperature recommendations.

PRESS



YOU SEE

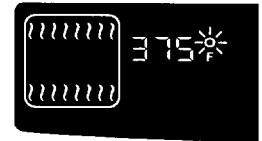

(example for Bake at 375°F [190°C])

4. Preheat oven.

After the temperature reaches 170°F (75°C), the temperature display will show the actual oven temperature at each 5°F (3°C) increase and stop at just about the set temperature. One long tone will sound when oven is preheated.

PRESS



YOU SEE

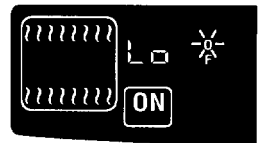

(example for Bake) ("Lo" is displayed after 5 seconds if oven temperature is below 170°F [75°C])

5. Put food in oven.

NOTE: If you want to change the baking temperature after baking has begun, repeat Steps 2, 3, and 4.

6. After cooking, turn off oven.

PRESS



YOU SEE

(display will go blank)

Using Your Oven

Convection roasting

NOTE: See the “Roasting tips” in the “Cooking tips” section.

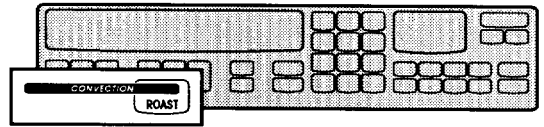

1. Prepare oven.

Position the rack properly. For correct rack placement, see “Baking or convection baking” earlier in this section. Place food in the oven. For large roasts and turkeys, place rack in position 1 or 2. (Preheating is not necessary when roasting.)

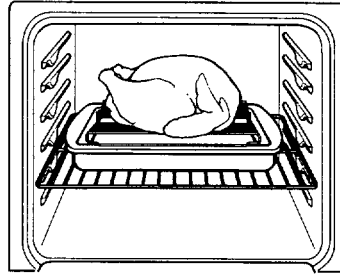

2. Choose setting.

PRESS



YOU SEE

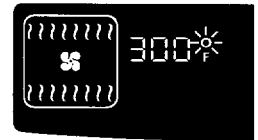

(or 150°C)

3. Set temperature (optional).

Do this step if you want to set a temperature other than 300°F (150°C).

NOTE: See your convection oven cookbook for temperature recommendations.

PRESS

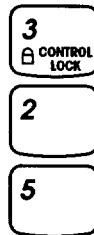

YOU SEE



(example shows 325°F [160°C] temperature setting)

4. Start oven.

NOTES:

- **After the temperature** reaches 170°F (75°C), the temperature display will show the actual oven temperature at each 5°F (3°C) increase and stop at just about the set temperature.
- **If you want to change** the roasting temperature after roasting has begun, repeat Steps 2, 3, and 4.

PRESS



YOU SEE

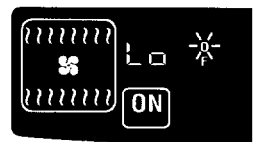

(“Lo” is displayed after 5 seconds if oven temperature is below 170°F [75°C])

5. After cooking, turn off oven.

PRESS



YOU SEE

(display will go blank)

Cooking tips

Baking/convection baking tips

The hot air must circulate around the pans in the oven for even heat to reach all parts of the oven. This results in better baking.

For best air circulation:

- **Place** the pans so that one is not directly over the other.



- **For best results**, allow 1 1/2 to 2 inches (4.5 to 6 cm) of space around each pan and between pans and oven walls.
- **When baking with one pan**, place pan in the center of the oven rack.

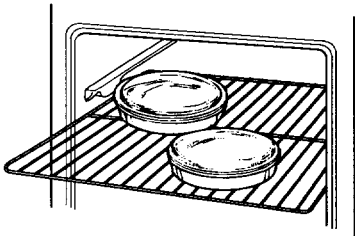

- **When baking with two pans**, place pans in opposite corners of the oven rack.

NOTE: "Oven peeking" may cause heat loss, longer cooking times, and unsatisfactory baking or roasting results. Rely on your timer.

Baking tips

(Bake pad)

For proper cooking, follow these guidelines:

- **When using one rack**, place the rack so the top of the food will be centered in the oven.
- **When using more than one rack**, use the Convection Bake setting.
- **Use only one** cookie sheet in the oven at a time when using the Bake setting.

Bakeware tips

- **When baking with insulated cookie sheets or baking pans**, place them in the bottom third of the oven. You may need to increase the recommended baking times, so test for doneness before removing from the oven.
- **When using ovenproof glassware or dark bakeware**, reduce the oven temperature by 25°F (16°C), but use the same baking time. Because these pans absorb heat, producing darker bottom browning and crispier crusts, place the rack in the center of the oven. When baking pies and bread, you can use the temperature called for in the recipe.

Rack placement for specific foods:

FOOD	RACK POSITION
Frozen pies	2
Angel food and bundt cakes, most quick breads, yeast breads, casseroles, meats	1 or 2
Cookies, biscuits, muffins, cakes, nonfrozen pies	2 or 3

Using aluminum foil in the oven (for thermal baking)

Use aluminum foil to catch spillovers from pies or casseroles.

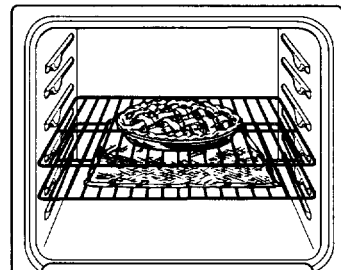

- **Place** the foil on the oven rack below the rack with the food. Turn foil edges up and make sure foil is about 1 inch (3 cm) larger all around than the dish holding the food.

Using Your Oven

- **Do not cover** the entire rack with aluminum foil. It will reduce air circulation and cause poor cooking results.

NOTE: Do not line oven bottom with foil or other liners. It could affect the quality of your baking.

Convection baking tips

(Convection Bake pad)

- **Do not use** aluminum foil when convection baking. Aluminum foil may block airflow.
 - **Reduce** recommended recipe oven temperature by approximately 25°F (16°C). Use EASY CONVECT* Conversion (see the “Using EASY CONVECT conversion” section).
 - **For some recipes**, you can reduce convection baking time compared to standard baking times. Use EASY CONVECT Conversion (see the “Using EASY CONVECT conversion” section).
- NOTE:** Cooking time may be longer when you use more than one rack.
- **When baking on two or three racks**, use the Convection Bake setting for more even results. (You can, however, use only one rack when convection baking.)

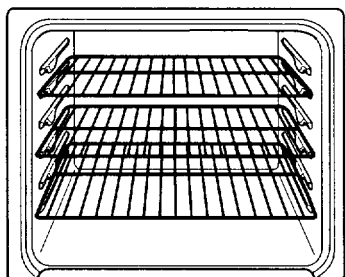

- **To use three racks during convection baking**, place one rack in position 5 (the highest position), another rack in position 1 (the closest to the oven bottom), and the third rack in position 3. This allows all three racks to be an equal distance apart for better baking.
- **Stagger** cake pans or other cookware in opposite directions on each rack when three racks are used. This will make sure pans are not directly over each other.

Roasting tips

- **Spatter can be reduced** by lining the bottom of the roasting pan with lightly crushed aluminum foil.
- **Use an accurate meat thermometer or temperature probe** (see the “Using the temperature probe” section) to determine when meat has reached desired degree of doneness. Insert the thermometer or probe into the center of the thickest portion of the meat or inner thigh or breast of poultry. For an accurate reading, the tip of the thermometer or probe should not touch fat, bone, or gristle.
- **After reading the thermometer once**, push it further into the meat ½ inch or more and read again. If the temperature drops, return the meat to the oven for more cooking.
- **Check pork and poultry** with a thermometer in 2 to 3 places to ensure adequate doneness.
- **Poultry and roasts will be easier to carve** if loosely covered with foil and allowed to stand 10 to 15 minutes after removal from the oven.
- **You can reduce** roasting times and temperatures for most standard recipes when using the Convection Roast setting. See convection roasting chart in your convection oven cookbook for recommended roasting times and temperatures, or use EASY CONVECT Conversion (see the “Using EASY CONVECT conversion” section).

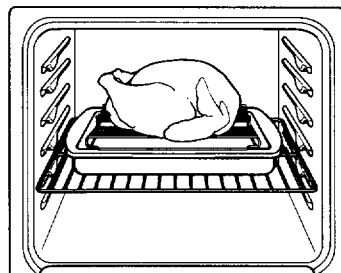

- **Use the convection roasting rack** on the broiler pan and grid (all included with your oven). (The convection roasting rack rests on the broiler pan and grid.) The long side of the rack should be parallel with the oven door for best heat distribution and airflow.

Adjusting oven temperature

Although your new oven is properly adjusted to provide accurate temperatures, it may cook faster or slower than your old oven.

If, after using the oven for a period of time, you are not satisfied with the baking/roasting results, you can change the offset temperature by following the steps below. The control will “remember” the selected offset even after the power has been interrupted or lost.

NOTE: DO NOT measure oven temperature with a thermometer. Opening the oven door will lower the oven temperature and give you an inaccurate reading. Also, the thermometer temperature reading will change as your oven cycles.

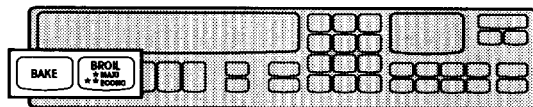

1. Press and hold Bake pad for 5 seconds.

Release the pad when a number and CAL appear on the temperature display and you hear a tone.

PRESS



Hold for
5 seconds

YOU SEE



(factory setting of “0”)

2. Set new offset temperature.

You can set the offset temperature adjustment as low as -35°F (-21°C) or as high as +35°F (+21°C). Each time you press the Bake pad, the displayed temperature will increase by 5°F (3°C). Each time you press the Broil pad, the displayed temperature will decrease by 5°F (3°C). (To determine the amount of adjustment needed, see the chart later in this section.)

NOTE: If there is no “F” after the temperature, you are in the Celsius mode.

PRESS



OR



YOU SEE



(example when making
oven 10°F [or 6°C]
hotter)

3. Enter the adjustment.

NOTE: If you press the Lower Oven Cancel pad instead of the Start pad, the offset temperature will stay the same.

PRESS



YOU SEE

(display will go blank)

continued on next page

Using Your Oven

How to determine the amount of adjustment needed

The following chart tells you how much to adjust the offset temperature to get the desired cooking results. You can determine cooking results by amount of browning, moistness, and rising times for baked foods.

TO COOK FOOD ...	ADJUST BY THIS NUMBER OF DEGREES
A little more	+5°F to +10°F/ +3°C to +6°C
Moderately more	+15°F to +20°F/ +8°C to +12°C
Much more	+25°F to +35°F/ +16°C to +21°C
A little less	-5°F to -10°F/ -3°C to -6°C
Moderately less	-15°F to -20°F/ -8°C to -12°C
Much less	-25°F to -35°F/ -16°C to -21°C

Using the temperature probe

The Temperature Probe is the most accurate guide to the degree of doneness of meat. Use it when baking, roasting any type of meat or poultry, or cooking casseroles with liquid.

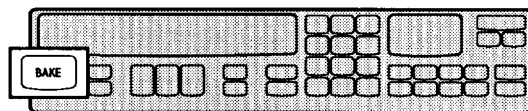

NOTES:

- **Do not use** the Temperature Probe when broiling, convection broiling, dehydrating, or raising bread.
- **Unplug** the Temperature Probe before self-cleaning the oven.

1. Insert probe into food.

Insert the probe into the center of the thickest portion of meat or into the inner thigh or breast of poultry, away from fat or bone.

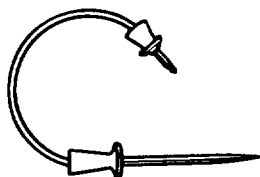

2. Put food in oven.

Place meat on the convection roasting rack, place rack on broiler pan and grid, and place pan in the center of the oven.

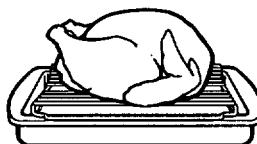

Using Your Oven

3. Connect probe to oven.

Locate the Temperature Probe jack on the right side of the oven wall. Insert plug into jack. (Keep the top of the probe as far as possible from the heat source.)

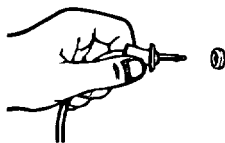

YOU SEE



(or 71°C)

4. Close oven door.

5. Set temperature (optional).

Do this step if you want to set an internal food temperature (from 130°F [54°C] to 190°F [88°C]) other than 160°F (72°C).

NOTE: See a reliable cookbook or your convection oven cookbook for internal food temperature recommendations.

PRESS



YOU SEE



(example shows 185°F [86°C] internal temperature setting)

6. Choose cook setting:

- BAKE,
- CONVECTION BAKE, or
- CONVECTION ROAST.

NOTE: If you press Clean, Cook Time, Stop Time, or Broil pads the display will show “pull prb out.”

PRESS



(example for Bake)

YOU SEE

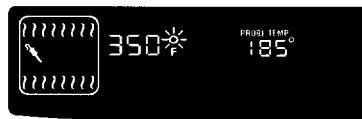

(or 175°C)

7. Set temperature (optional).

Do this step if you want to set an oven temperature other than the one displayed.

NOTE: See a reliable cookbook or your convection oven cookbook for oven temperature recommendations.

PRESS



YOU SEE



(example shows 375°F [190°C] temperature setting)

continued on next page

Using Your Oven

8. Start oven.

NOTES:

- **If you do not choose** a cook setting and press START, the oven will default to bake at 350°F (175°C) and start. If you want to cook with another setting or at another temperature, do Steps 6 and 7 and press START.
- **The temperature display** will show the set oven temperature throughout temperature probe cooking.
- **After the food temperature** reaches 130°F (54°C), the probe display will show the actual food temperature at each 5°F increase and stop at the set temperature. Four tones will sound and “End” will show when food reaches the set temperature. The oven then shuts off.
- **If you want to change** the probe temperature after cooking has begun:
 - Unplug the probe, then plug it back in. You will be prompted for a new probe temperature. Next, repeat Steps 4, 5, and 8 in that order. You may also change the oven temperature at this point by pressing the desired cook setting pad again.

OR

- You may change the oven temperature at this point by pressing the desired cook setting pad again.

PRESS



YOU SEE



(example for Bake)

⚠ WARNING

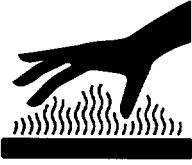

Burn Hazard

Use an oven mitt to remove temperature probe.

Do not touch broil element.

Failure to follow these instructions can result in burns.

9. After cooking, unplug probe.

The probe symbol will remain lit until you unplug the Temperature Probe.

10. Remove food from oven.

(This prevents overcooking.)

11. Clean probe.

Wash with a soapy sponge and dry thoroughly. Use a plastic scouring pad to remove cooked-on foods. You can also clean the probe in a dishwasher.

Using CONVECT FULL MEAL

CONVECT FULL MEAL lets you choose from among ten preset oven convection cooking cycles, all using the convection fan. These cycles store commonly used cooking times, cooking temperatures, and probe temperature settings. CONVECT FULL MEAL saves you time by limiting the number of pads you have to press when cooking at a favorite setting. CONVECT FULL MEAL also lets you set your own favorite cycle (either convection or nonconvection).

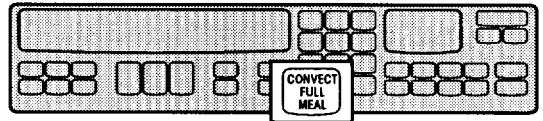

1. Place food in cold oven.

If you need the Temperature Probe for your cycle (settings 6 to 0 in the "Convection full meal chart" later in this section), insert probe into food. Place food in oven and plug probe into jack.

Using Your Oven

2. Press Convect Full Meal pad.

PRESS



YOU SEE

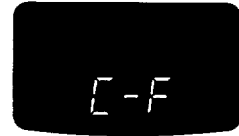

("C" stands for "cycle,"
"F" stands for "favorite")

3. Press desired Number pad.

Use the "Convect full meal chart" later in this section as your guide for selecting a cycle.

NOTES:

- **You can change** the Convect Full Meal cycle any time before pressing the Start pad by repeating Step 3.
- **You can program your own setting**, which you can then select in the future by pressing just Convect Full Meal and start pads. (See "To program your own setting" later in this section for more information.)

PRESS



YOU SEE



(example for cycle 1)



(or 160°C)

4. Start oven.

PRESS



YOU SEE



5. When the Convect Full Meal cycle is done:

Four tones will sound, followed by four reminder tones (unless they have been disabled) every minute until you open the door, remove the probe, or press the Lower Oven Cancel pad.

YOU SEE



Using Your Oven

Convect full meal chart

SETTING NUMBER	CONVECTION CYCLE	OVEN TEMP	TIME OR PROBE TEMP	FOOD OR MEAL
1	Conv. Bake	325°F (160°C)	1 hr	Meal#1: Spinach and ricotta stuffed meat loaf, Baked potatoes, Fall apple cake
2	Conv. Roast	325°F (160°C)	1½ hrs	Meal#2: Pesto stuffed turkey breast, Caramel-sweet potato casserole, Rhubarb-pineapple crisp
3	Conv. Roast	350°F (175°C)	40 min	Meal#3: Pork chops with currant-nut stuffing, Cherry cobbler
4	Conv. Bake	375°F (190°C)	45 min	Meal#4: Herb and pecan fried chicken, Crispy potato wedges, Apple-sauce rhubarb muffins
5	Conv. Bake	425°F (220°C)	20 min	Meal#5: Spicy red snapper, Gruyere pecan biscuits
6	Conv. Roast	325°F (160°C)	140°F (60°C)	Beef, rare
7	Conv. Roast	325°F (160°C)	155°F (68°C)	Beef, medium Pork
8	Conv. Roast	325°F (160°C)	165°F (74°C)	Beef, well done
9	Conv. Roast	300°F (150°C)	135°F (56°C)	Ham, fully cooked
0	Conv. Bake	325°F (160°C)	160°F (71°C)	Casseroles

NOTE: For the recipes for Meals #1 – #5 see the cookbook that comes with your oven.

To program your own setting:

1. **Press** Convect Full Meal pad.
2. **Press** the Command Pad to the cook setting you want (for example, BAKE).
3. **Enter** the temperature and cook time you want. (The default is Bake at 170°F (75°C) for 2 hours.) Entering a cook time of 0 minutes lets you do untimed cooking.
4. **To save only, press** Convect Full Meal pad.

To cook with this setting immediately and save it, press Start pad.

When programming your own setting:

1. **Start** with meat or main dish items (times are more critical with these items).
2. **Choose** baked goods with bake temperatures similar to those of meat or main dish items. Convection baking time of +/-10 to 15 minutes and temperatures of +/-25 to 50 degrees are acceptable.
3. **Choose** vegetables and fruits last.

Using Your Oven

Using EASY CONVECT* Conversion

EASY CONVECT Conversion lets you convection cook without entering convection cook temperatures and times. Simply enter the standard cook temperature and time for the food to be cooked. The oven will reduce the temperature, or the temperature and time, for convection cooking. (Convection temperatures and times are not as long because the heated air is circulated in the oven cavity for quicker cooking.)

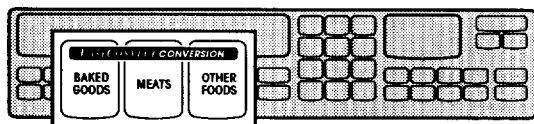

NOTE: The converted temperatures and times are not precise because the food categories you choose from are general. (See “EASY CONVECT Conversion setting chart” later in this section for which foods you can cook in each category.) To ensure proper cooking, the oven will prompt you to check food at the end of cook time. If food needs more cooking, the oven will continue to cook. If food does not need more cooking, press the Lower Oven Cancel pad.

1. Place food in oven.

NOTE: For Baked Goods and Other Foods, place food in the oven after the oven has been preheated.

2. Press one of three EASY CONVECT Conversion Pads.

Example for Meats:

PRESS



YOU SEE



3. Enter standard cook temperature.

PRESS



YOU SEE



(example showing 325°F [160°C] – cooking without temperature probe)

4. Enter standard cook time.

NOTE: To delay convection cooking, after Step 4, press the Stop Time pad and enter the desired stop time. Cooking will start at the time equal to the stop time less the cook time. (Example: A cook time of 1 hour and a stop time of 4:00 would give you a start time of 3:00.)

PRESS

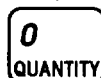
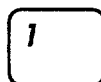

YOU SEE



(example showing 1 hour)

Using Your Oven

5. Start oven.

NOTES:

- **The actual temperature reduction and time savings are different for each food category and oven type.**
- **For Baked Goods and Other Foods,** place food in the oven after the oven has been preheated.

PRESS



YOU SEE



(display shows temperature reduced by 25°F [16°C] – nondelayed cooking)

6. At end of cook time (nondelayed cooking):

YOU SEE



7. Open door and check food (nondelayed cooking).

If you want to continue cooking, close door and the oven will continue cooking. If you do not want to continue cooking, press the Lower Oven Cancel pad.

YOU SEE

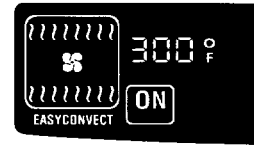

8. When stop time is reached (delayed cooking only):

Four tones will sound, followed by four reminder tones (unless they have been disabled) every minute until you open the door or press the Lower Oven Cancel pad.

YOU SEE

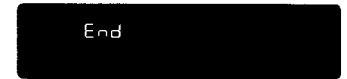

EASY CONVECT* Conversion setting chart

EASY CONVECT SETTING	FOODS YOU CAN COOK WITH THIS SETTING
Baked Goods	Cakes: layer, angel food Breads: quick and yeast Biscuits and cookies Casseroles, including frozen entrees and soufflés Fish
Meats	Chicken: whole and pieces Roasts: pork, beef, and ham Meat loaf Baked potatoes NOTE: Turkey or large poultry are not included because their cooking times vary.
Other Foods	Convenience foods: French fries, nuggets, fish sticks, pizza Pies: fruit and custard

Using Your Oven

Broiling

NOTE: Preheating is not necessary when broiling.

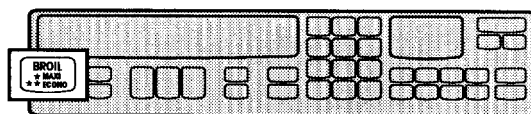

1. Position rack.

See "Broiling rack positions" in the "Broiling tips" section for recommended rack positions.

NOTES:

- **Before turning oven on** position oven rack(s) in desired location.
- **Be sure** the rack(s) is level.
- **Use pot holders or oven mitts** to protect hands if rack(s) must be moved while oven is hot.
- **Do not let** pot holder or oven mitt touch hot broil element.

NOTE: See the "Broiling tips" section for additional broiling tips.

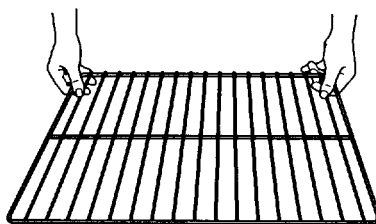

2. Put food in oven.

Place food on grid in broiler pan and place in center of the oven rack.

NOTES:

- **Place food** about 3 inches or more from the broil element.
- **To ensure adequate grease drainage,** do not use cookie sheets or similar pans for broiling.
- **If foil is used** to cover broiler grid, cut slits in foil to allow grease to drain away.

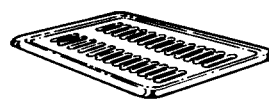

Broiler grid



Broiler pan

3. Close door.

NOTE: Do not keep the door open as on other electric ovens. Unlike other electric ovens, the broil element will only stay on with the door closed. This gives you the high heat you need for broiling. However, if you leave the door open, the broil element will go off.

Using Your Oven

4. Press Broil pad.

Once for Maxi Broil
(See the “Oven settings” section for description of Maxi Broil.)

PRESS



YOU SEE

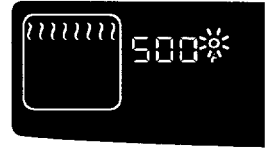

(or 260°C) (example for Maxi Broil)

OR

Twice for Econo Broil
(See the “Oven settings” section for description of Econo Broil.)

PRESS



YOU SEE

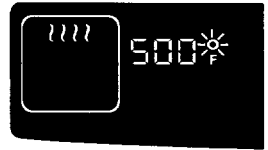

(or 260°C) (example for Econo Broil)

5. Set temperature (optional).

Do this step if you want to use variable temperature broiling (see “Variable temperature broiling” later in this section).

PRESS



YOU SEE

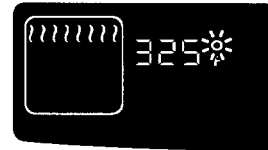

(example shows 325°F [160°C])
broiling temperature for Maxi Broil)

6. Start oven.

NOTE: If you want to change the broiling temperature after broiling has begun, repeat Steps 4, 5, and 6.

PRESS



YOU SEE



(example for Maxi Broil)

continued on next page

Using Your Oven

**7. When broiling is done,
turn off oven.**

PRESS

**LOWER OVEN
CANCEL**

YOU SEE

(display will go blank)

Variable temperature broiling

- **If food is cooking too fast** or you want the food to broil slower from the start, set the broil temperature between 170°F (75°C) and 325°F (160°C). These temperature settings allow the broil heating element to cycle less frequently and to slow cooking. The lower the temperature, the slower the cooking.
- **Fish and chicken** are some foods that may cook better if you use lower broiling temperatures.

Using Your Oven

Convection broiling

Use this setting when broiling thick cuts of meat.

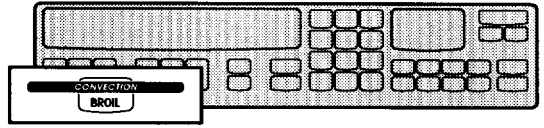

1. Position rack.

See "Broiling rack positions" in the "Broiling tips" section for recommended rack positions.

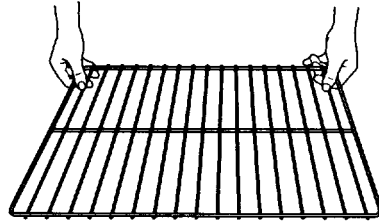

2. Close door.

NOTE: Do not try to convection broil with the door open. The fan and elements will not operate.

3. Choose Convection Broil setting.

PRESS



YOU SEE



(or 235°C)

4. Set temperature (optional).

Do this step if you want to set a temperature (up to 500°F [260°C]) other than 450°F (235°C).

NOTE: See your convection oven cookbook for temperature recommendations.

PRESS



YOU SEE

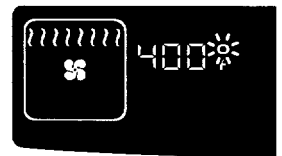

(example shows 400°F (205°C) temperature setting)

continued on next page

Using Your Oven

5. Preheat oven.

NOTE: If you want to change the convection broiling temperature after broiling has begun, repeat Steps 3, 4, and 5.

PRESS



YOU SEE

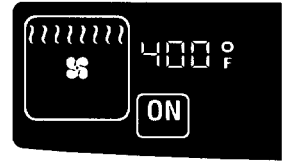

(or 205°C)

6. Put food in oven.

Place food on grid in broiler pan and place in center of the oven rack. Turn the pan so the long side is parallel to the oven door for the most even heat and the best airflow.

NOTE: If you want to change the convection broiling temperature after broiling has begun, repeat Steps 3, 4, and 5.

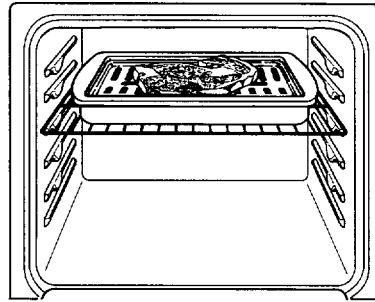

7. When broiling is over, turn off oven.

PRESS



YOU SEE

(display will go blank)

Broiling tips

- **Always start** broiling with a cold broiler pan for better results.
- **To retain more natural juice**, do not pierce meat with a fork.
- **Trim** the outer layer of fat from steaks and chops.
- **Slit** fatty edges to prevent meat from curling during broiling.
- **Use a nonstick cooking spray or vegetable oil** on the broiler pan and grid when broiling fish to prevent sticking.

NOTE: See the "Broiling" section for additional broiling tips.

Broiling rack positions

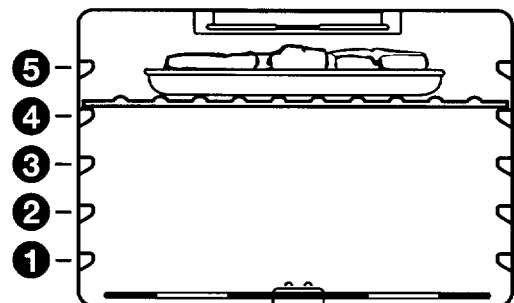

Timed cooking

The electronic clock/oven control will turn the oven on and off at times you set, even when you are not around.

Delayed time cooking is ideal for foods which do not require a preheated oven, such as meats and casseroles. **Do not use delayed time cooking for cakes, cookies, etc. – they will not rise properly. Before using timed cooking, make sure the clock is set to the correct time of day.** (See the “Setting the clock” section.)

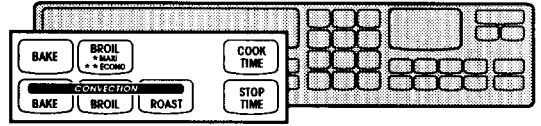

⚠ WARNING

Food Poisoning Hazard

Do not let food sit in oven more than one hour before or after cooking.

Doing so can result in death, food poisoning, or sickness.

To start now and stop automatically:

1. Prepare oven.

Position the oven rack(s) properly and place the food in the oven. For correct rack placement, see “Rack positions” in the “Baking or convection baking” section and the “Rack placement” chart in the “Cooking tips” section.

2. Choose setting:

- BAKE,
- CONVECTION BAKE,
- CONVECTION ROAST,
- BROIL, or
- CONVECTION BROIL.

PRESS



YOU SEE

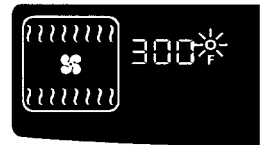

(or 150°C)
(example for
Convection Roast)

continued on next page

Using Your Oven

3. Set temperature (optional).

Do this step if you want to set a temperature other than the one displayed.

NOTE: See a reliable cookbook or your convection oven cookbook for temperature recommendations.

PRESS



YOU SEE

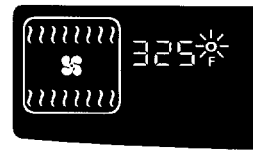

(example shows 325°F [160°C] temperature setting in Convection Roast)

4. Press Cook Time pad.

PRESS



YOU SEE



(start time display will light up, showing time of day)

5. Set cook time.

PRESS

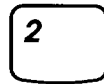

YOU SEE



(example shows 2-hour cook time with stop time 2 hours later than time of day)

6. Start oven.

Vertical bar on display will get shorter as cook time counts down.

PRESS



YOU SEE

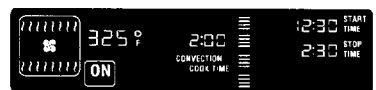

(cook time is displayed)

7. When baking/roasting is done:

"End" will show on the display. Four tones will sound, followed by four reminder tones (unless they have been disabled) every minute until you open the door, or press the Lower Oven Cancel pad.

YOU SEE



Using Your Oven

To delay start and stop automatically:

1. Prepare oven.

Position the oven rack(s) properly and place the food in the oven. For correct rack placement, see "Rack positions" in the "Baking or convection baking" section and the "Rack placement" chart in the "Cooking tips" section.

2. Choose setting:

- BAKE,
- CONVECTION BAKE,
- CONVECTION ROAST,
- BROIL, or
- CONVECTION BROIL.

PRESS



YOU SEE

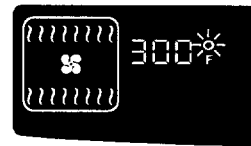

(or 150°C)
(example for
Convection Roast)

3. Set temperature (optional).

Do this step if you want to set a temperature other than the one displayed.

NOTE: See a reliable cookbook or your convection oven cookbook for temperature recommendations.

PRESS



YOU SEE

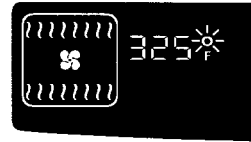

(example shows 325°F
[160°C] temperature
setting in Convection
Roast)

4. Press Cook Time pad.

PRESS



YOU SEE



(start time display will light up,
showing time of day)

5. Set cook time.

PRESS

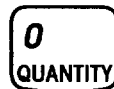
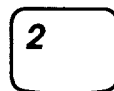

YOU SEE



(example shows 2-hour cook
time with stop time 2 hours later
than time of day)

Using Your Oven

6. Press Stop Time pad.

PRESS



YOU SEE



7. Set stop time.

PRESS



YOU SEE

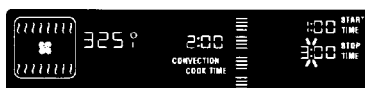

(stop time display shows 3:00 and start time display shows 1:00 – stop time minus 2-hour cook time)

8. Press Start pad.

PRESS



YOU SEE



When start time is reached:

Vertical bar on display will get shorter as cook time counts down.

YOU SEE

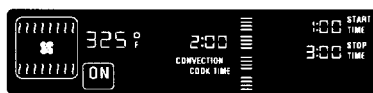

9. When baking/roasting is done:

“End” will show on the display. Four tones will sound, followed by four reminder tones (unless they have been disabled) every minute until you open the door, or press the Lower Oven Cancel pad.

YOU SEE



To cancel timed cooking settings:

Press Lower Oven Cancel pad.

PRESS



YOU SEE

(display will go blank)

Using Your Oven

Dehydrating

You can use your THERMAL-CONVECTION* oven to dehydrate a variety of foods.

NOTES:

- **To learn** detailed information about dehydration, refer to a book written specifically about dehydrating and/or preserving foods.
- **If you do not turn off oven** after dehydrating, the oven will keep running until you press LOWER OVEN CANCEL.

1. Prepare food.

Prepare foods as recommended in recipe.

2. Arrange food on drying racks.

Racks are not included with oven. See below to order a dehydration kit† which includes racks and a spacer or contact a local store handling specialty cookware.

3. Place drying racks in the oven to allow maximum air circulation around the racks.

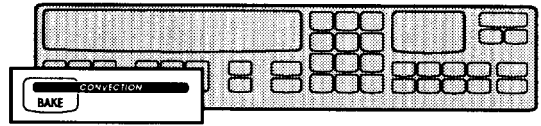

NUMBER OF RACKS	USE OVEN RACK POSITION
1 rack	3
2 racks	2 and 4
3 racks	1, 3, and 5

4. Position door.

Attach the dehydration spacer†, which is specially designed to depress the oven light plunger and maintain the operation of the fan during dehydration.

The spacer provides a 1-inch gap between the oven frame and the oven door allowing moisture to escape.

† The dehydration spacer (Part No. 814166) or the dehydration kit which includes racks and a spacer (Part No. 4395974) can be ordered from your local KitchenAid dealer, or by calling **1-800-422-1230** and following the instructions and telephone prompts you hear.

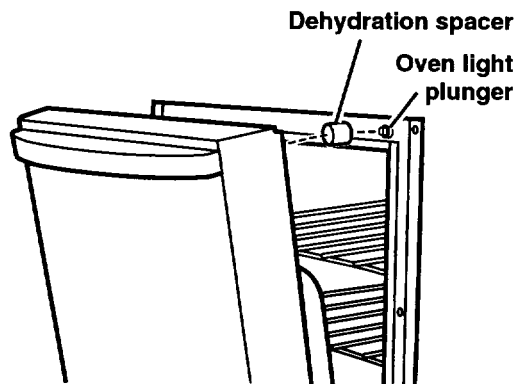

Using Your Oven

-
- 5. Press and hold Convection Bake pad for 5 seconds.**

PRESS



Hold for
5 seconds

YOU SEE



(or 60°C)

-
- 6. Set temperature (optional).**

Do this step if you want to set a temperature (from 100°F [38°C] to 200°F [95°C]) other than 140°F (60°C).

PRESS

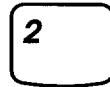

YOU SEE



(example shows
125°F [52°C] dehy-
drating temperature)

-
- 7. Start oven.**

NOTE: If you want to change the dehydrating temperature after dehydrating has begun, repeat Steps 5, 6, and 7.

PRESS



YOU SEE



-
- 8. When dehydrating is done, turn off oven.**

PRESS



YOU SEE

(display will go blank)

Using Your Oven

Raising (proofing) bread

You can use your THERMAL-CONVECTION* oven to proof bread. For more information see the convection oven cookbook, provided with your oven.

1. Put dough in oven.

NOTE: Be sure to close the door.

2. Press and hold Baked Goods pad for 5 seconds.

PRESS



Hold for 5 seconds

YOU SEE



(or 38°C)

3. Start oven.

One long tone will sound when oven is preheated.

PRESS



YOU SEE



4. When proofing is done, turn off oven.

NOTE: If you do not turn off oven after proofing bread, the oven will keep running until you press the Lower Oven Cancel Pad.

PRESS



YOU SEE

(display will go blank)

The oven vent

Hot air and moisture escape from the lower oven through a vent. This vent is above the oven door. It is needed for air circulation.

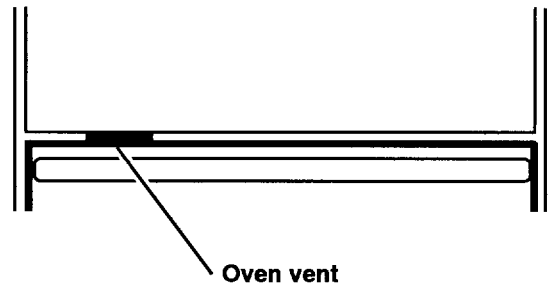

Caring for Your Oven



!WARNING

Explosion Hazard

Do not store flammable materials such as gasoline near this appliance.

Doing so can result in death, explosion, or fire.

Cleaning your oven and controls

PART	WHAT TO USE	HOW TO CLEAN
Control panel	<p>Sponge and warm, soapy water</p> <p>OR</p> <p>Paper towel and spray glass cleaner</p>	<ul style="list-style-type: none"> Wash, wipe with clean water, and dry thoroughly. Do not use steel wool or abrasive cleansers. They may damage the finish. Do not spray cleaner directly on panel. Apply cleaner to paper towel. <p>NOTE: Set the Control Lock to prevent the oven from accidentally turning on when you are cleaning the panel. (See "Using the control lock" in the "Using the electronic oven control" section.)</p>
<p>Exterior surfaces (other than control panel)</p> <p>Stainless steel surfaces</p>	<p>Sponge and warm, soapy water</p>	<ul style="list-style-type: none"> Wash, wipe with clean water, and dry thoroughly. Use nonabrasive, plastic scrubbing pad on heavily-soiled areas. Do not use abrasive or harsh cleansers. They may damage the finish. Do not use steel wool or soap-filled scouring pads. Rub in the direction of the grain line to avoid marring the surface. Always wipe dry to avoid water marks. If commercial cleaners are used, follow label directions. If product contains chlorine (bleach), wipe thoroughly with clean water and dry with a soft lint-free cloth. Chlorine is a corrosive substance.
<ul style="list-style-type: none"> Routine cleaning and fingerprints 	<p>Liquid detergent/soap and water, or all-purpose cleaner</p>	<ul style="list-style-type: none"> Wipe with damp cloth or sponge, then wipe with clean water and dry.

Caring for Your Oven

PART	WHAT TO USE	HOW TO CLEAN
Stainless steel surfaces (cont.) <ul style="list-style-type: none"> • Stubborn stains and baked-on residue • Hard water spots 	Mildly abrasive cleanser or stainless-steel cleaners Vinegar	<ul style="list-style-type: none"> • To avoid marring the surface, rub in the direction of grain lines with a damp cloth or sponge and cleanser. Wipe thoroughly with clean water. Repeat if necessary. • Swab or wipe with cloth. Wipe with clean water and dry.
Broiler pan and grid (clean after each use)	Steel-wool pad and warm, soapy water	<ul style="list-style-type: none"> • Wash, rinse, and dry thoroughly. • Do not clean in the Self-Cleaning cycle. (See “Before you start” in the “Using the Self-Cleaning Cycle” section.)
Oven racks	Steel-wool pad and warm, soapy water OR The Self-Cleaning cycle	<ul style="list-style-type: none"> • Wash, rinse, and dry thoroughly. <p>OR</p> <ul style="list-style-type: none"> • Leave in oven during Self-Cleaning cycle. <p>NOTE: Racks will permanently discolor and become harder to slide if left in oven during the Self-Cleaning cycle. Apply a small amount of vegetable oil to the side rungs to aid sliding.</p>
Oven door glass	Paper towel and spray glass cleaner OR Warm, soapy water and a nonabrasive, plastic scrubbing pad	<ul style="list-style-type: none"> • Make sure oven is cool. • Follow directions provided with the cleaner. • Wash, wipe with clean water, and dry thoroughly.
Oven cavity	Self-Cleaning cycle	<ul style="list-style-type: none"> • Wipe up food spills containing sugar as soon as possible after the oven cools down. (See the “Using the Self-Cleaning Cycle” section.) • See the “Using the Self-Cleaning Cycle” section.

Caring for Your Oven

Removing the oven door

For normal use of your oven, you do not need to remove the door. However, you can remove the door by following the instructions in this section.

The oven door is heavy. Use both hands to remove and replace the door. Do not lift and carry the door by the handle. To remove and replace the door you may need help.

To remove:

1. **Open** door all the way.

NOTE: Two $\frac{5}{32}$ " Allen wrenches or two nails of similar diameter may be used if factory furnished door removal pins have been misplaced. Be careful not to damage porcelain finish.

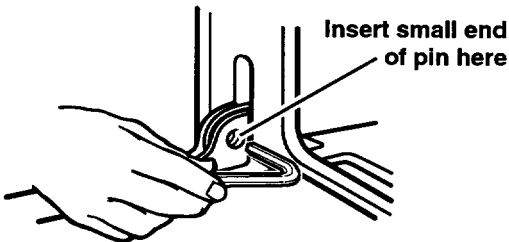

2. **Insert** small end of a door removal pin into each door hinge.

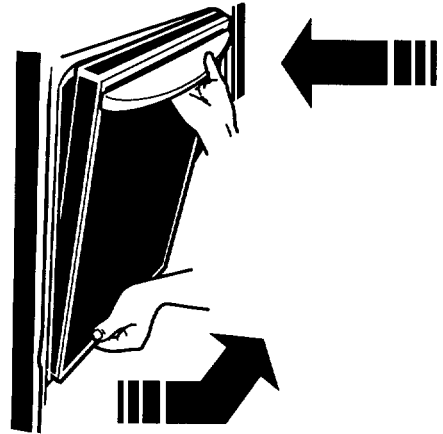

3. **Grasp** under handle and gently close door as far as it will shut. Pull door out at bottom to remove.
4. **Set** door aside on protected surface.



To replace:

1. **Fit** hinge arms into slots in frame. Push in at lower corners to insure that hinge arms are fully engaged.
2. **Open** the door all the way.
3. **Remove** the door removal pins from each hole.
4. **Close** the door.

NOTE: If the door does not operate freely, you have not installed it properly. Repeat Steps 1 to 4.



Using and replacing the oven lights

The oven lights will come on when you open the oven door. To turn the lights on when the oven door is closed, **press** the Oven Light pad  on the control panel. **Press** the pad  again to turn off the lights.

Replacing the oven light:

1. **Disconnect** appliance at the main power supply. Make sure the oven is cool before replacing the light bulb.

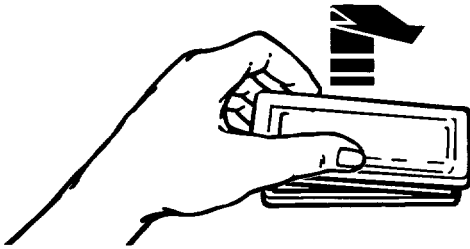

2. **Remove** glass light cover by grasping the front edge of cover and pulling it away from the side wall of the oven.

3. **Remove** the light bulb from its socket. **Replace** the bulb with another halogen bulb (12 volt, 5 watt maximum, available at most hardware stores).
4. **Replace** the light cover by snapping it back into wall. **Reconnect** appliance at main power supply.

NOTE: The oven lights will not work during the Self-Cleaning cycle.

Using the Self-Cleaning Cycle

The Self-Cleaning cycle saves you from the toil and mess that often come with hand-cleaning the oven interior. Like the other functions of your oven, you operate the Self-Cleaning cycle with the easy-to-use electronic control. To use this cycle properly, follow the step-by-step instructions in this section.

⚠ WARNING



Burn Hazard

Do not touch the oven during the Self-Cleaning cycle.
Keep children away from oven during Self-Cleaning cycle.
Do not use commercial oven cleaners in your oven.
Failure to follow these instructions can result in burns, or illness from inhaling dangerous fumes.

Before you start

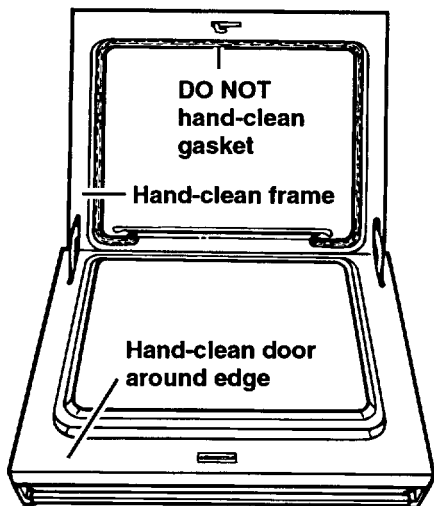

Before you start the Self-Cleaning cycle, make sure you:

- **Hand-clean the areas shown.** They do not get hot enough during the Self-Cleaning cycle for soil to burn away. Use hot water and detergent or a soapy, steel-wool pad for cleaning.

NOTES:

- **DO NOT** clean, move, or bend the gasket. Poor cleaning, baking, and roasting may result.
- **DO NOT** let water, cleaner, etc., enter slots on door and frame.

- **Remove** the broiler pan and grid and anything else being stored in the oven.
- **Wipe out** any loose soil or grease. This will help reduce smoke during the Self-Cleaning cycle.
- **Wipe up** food spills containing sugar as soon as possible after the oven cools down. When sugar is heated to a high temperature in the Self-Cleaning cycle, the high temperature can cause the sugar to burn and react with the porcelain. This can cause staining and etching or pitting.
- **Remove** the oven racks from the oven if you want them to remain shiny. You can clean the oven racks in the Self-Cleaning cycle, but they will become harder to slide. (See "Cleaning your oven and controls" in the "Caring for Your Oven" section.) If you clean racks in the Self-Cleaning cycle, place them on the 2nd and 4th rack guides. (Guides are counted from bottom to top.)
- **Heat and odors** are normal during the Self-Cleaning cycle. Keep the kitchen well ventilated by opening a window or by turning on a vent hood or other kitchen vent during the cycle.

Using the Self-Cleaning Cycle

NOTES:

- **Do not block** the oven vent during the Self-Cleaning cycle. Air must move freely for best cleaning results.
- **Do not leave** any foil in oven during the Self-Cleaning cycle. Foil could burn or melt and damage the oven surface.
- **The oven light** will not work during the Self-Cleaning cycle.

Before setting the controls

- **Make sure clock is set to correct time of day.**
- **Make sure the oven door is completely closed.**

Setting the controls

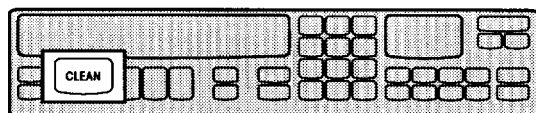

To start cleaning immediately:

1. Press Clean pad.

A 3½-hour Self-Cleaning cycle will be set. (The first 3 hours are for cleaning, the last 30 minutes are for cooling.)

PRESS



YOU SEE



(stop time display shows time 3½ hours later than time of day – shown in start time display)

2. Set cleaning time (optional).

If you want a Self-Cleaning cycle other than 3½ hours, **press** the desired Number pads for the new time from 2½ to 4½ hours.

- **Use** 2½ hours for light soil.
- **Use** 3½ to 4½ hours for moderate to heavy soil.

PRESS



YOU SEE



(example shows 4-hour cleaning cycle with stop time now 4 hours later than time of day)

3. Start oven.

NOTE: The door will lock right after you press START.

PRESS



YOU SEE



4. After the Self-Cleaning cycle ends:

YOU SEE



Using the Self-Cleaning Cycle

To delay cleaning start time:

1. Press Clean pad.

A 3½-hour Self-Cleaning cycle will be set. (The first 3 hours are for cleaning, the last 30 minutes are for cooling.)

PRESS



YOU SEE



(stop time display shows time 3½ hours later than time of day – shown in start time display)

2. Set cleaning time (optional).

If you want a Self-Cleaning cycle other than 3½ hours, press the desired Number pads for the new time from 2½ to 4½ hours.

- Use 2½ hours for light soil.
- Use 3½ to 4½ hours for moderate to heavy soil.

PRESS



YOU SEE



(example shows 4-hour cleaning cycle with stop time now 4 hours later than time of day)

3. Press Stop Time pad.

PRESS



YOU SEE



4. Set Stop time.

Example for 7:00:

PRESS

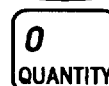
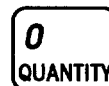

YOU SEE



Using the Self-Cleaning Cycle

5. Complete entry.

NOTES:

- The door will lock right after you press START.
- Lights will stay on until start time is reached.

When the start time is reached:

PRESS



YOU SEE



(display shows stop time of 7:00 and start time of 3:00 – stop time minus cleaning time)

YOU SEE



6. After the Self-Cleaning cycle ends:

YOU SEE



To stop the Self-Cleaning cycle at any time:

PRESS



YOU SEE



("too hot" and "DOOR LOCKED" will appear if oven has not cooled down and you try to program another cooking function)

For best cleaning results

- After the oven cools to room temperature, wipe up any residue or ash with a damp cloth or sponge. If any spots remain, clean with a mild abrasive cleanser or cleaning sponge.
- Clean the oven before it gets heavily soiled. Cleaning a very soiled oven takes longer and results in more smoke than usual.
- If the Self-Cleaning cycle does not get the oven as clean as you expected, the cycle may not have been set long enough or you may not have prepared the oven properly. Set the Self-Cleaning cycle longer the next time and hand-clean areas noted in "Before you start" earlier in this section.

Using the Self-Cleaning Cycle

How the cycle works

The Self-Cleaning cycle uses very high heat to burn away soil and grease. During the cycle, the oven gets much hotter than it does for normal baking or broiling. This high heat breaks up the soil or grease and burns it away.

Your oven is preset for a 3½-hour Self-Cleaning cycle. However, you can adjust the cycle time to the amount of soil in your oven. You can set the cycle anywhere between 2½ and 4½ hours. (See “Setting the controls” earlier in this section.)

The graph at the right is representative of a normal, 3½-hour Self-Cleaning cycle. Note that the heating stops after 3 hours, but it takes longer for the oven to cool enough to unlock.

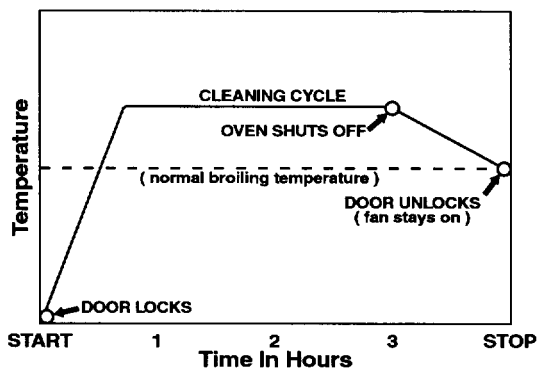

Troubleshooting

Most cooking problems often are caused by little things you can find and fix without tools of any kind. Check the lists below and on the next page before calling for assistance or service. If you still need help, see "Requesting Assistance or Service" on pages 51 and 52.

If nothing operates, check the following:

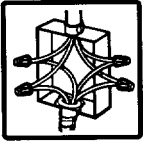

Is the oven wired into a live circuit with the proper voltage?
(See Installation Instructions.)

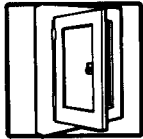

Have you blown a household fuse or tripped a circuit breaker?



Other possible problems and their causes:

PROBLEM	CAUSE
The oven will not operate	<ul style="list-style-type: none">• You have not set the electronic control correctly. Refer to the section in this manual describing the function you are operating.• You have programmed a delayed start time. Wait for the start time to be reached or cancel and reset the control.
The Self-Cleaning cycle will not operate	<ul style="list-style-type: none">• You have programmed a delayed start time. Wait for the start time to be reached or cancel and reset the control.
Display is blank	<ul style="list-style-type: none">• You have set the display not to show the clock time. To see the clock time again, press and hold the Clock Set/Start pad for 5 seconds.

continued on next page

Troubleshooting

PROBLEM	CAUSE
Cooking results are not what you expected	<ul style="list-style-type: none">• The oven is not level. (See Installation Instructions.)• The oven temperature seems too low or too high. See “Adjusting oven temperature” on page 19 to adjust oven temperature.• You did not preheat the oven before baking (if called for in recipe).• You are using a pan that is not the correct type or size. Refer to a reliable cookbook or recipe for recommended pan type and size.• There is not enough air space around pan when baking. Allow 1½ to 2 inches (4 to 5 cm) of air space on all sides of pan.
The display is showing “PF”	<ul style="list-style-type: none">• There has been a power failure. Reset the clock. (See page 12.)
A letter followed by a number shows on the display (for example “E3,” “F1”)	<ul style="list-style-type: none">• Press the Lower Oven Cancel pad. If the code reappears, note the code and call for service. (See Step 2 on pages 51 and 52.)
The key pads do not operate	<ul style="list-style-type: none">• The Control Lock has been set. (See “Using the control lock” on page 7.) Turn off the Control Lock by pressing and holding the Control Lock pad (Number Pad 3) for 5 seconds.• The Sabbath mode has been set (“Sab” appears on the display). Turn off the Sabbath mode by pressing and holding Number Pad 6 for 5 seconds.

If none of these items was causing your problem, see “Requesting Assistance or Service” on pages 51 and 52.

Requesting Assistance or Service

If you need assistance or service in the U.S.A.:

1. If the problem is not due to one of the items listed in the "Troubleshooting" section†:

- Call the KitchenAid Consumer Assistance Center:



1-800-422-1230

One of our trained consultants can instruct you in how to

obtain satisfactory operation from your appliance or, if service is necessary, recommend a qualified service company in your area.

- If you prefer, write to:

KitchenAid Brand Home Appliances
Consumer Assistance Center
c/o Correspondence Dept.
2000 North M-63
Benton Harbor, MI 49022-2692

Please include a daytime phone number in your correspondence.

2. If you need service†:

- Call your dealer or the repair service he recommends.



- All service should be handled locally by the dealer from whom you purchased the unit or an authorized KitchenAid servicer.

- If you are unable to obtain the name of a local authorized KitchenAid servicer, call our Consumer Assistance Center telephone number (see Step 1).

3. If you are not satisfied with the action taken:

- Contact the Major Appliance Consumer Action Program (MACAP). MACAP is a group of independent consumer experts that voices consumer views at the highest levels of the major appliance industry.
- Contact MACAP only when the dealer, authorized servicer, and KitchenAid have failed to resolve your problem.

Major Appliance Consumer Action Program
20 North Wacker Drive
Chicago, IL 60606

- MACAP will in turn inform us of your action.

† When asking for help or service:

Please provide a detailed description of the problem (including any information that appears on the electronic control display), your appliance's complete model and serial numbers, and the purchase date. (See the "A Note to You" section.) This information will help us respond properly to your request.

Don't forget, KitchenAid offers a full line of quality home appliances.

Built-In Refrigerators

Trash Compactors

Ranges & Cooktops

Freestanding Refrigerators

Hot Water Dispensers

Microwave Ovens

50-Pound Ice Makers

Food Waste Disposers

Washers & Dryers

Dishwashers

Built-In Ovens

Mixers & Blenders

For more information on these appliances, or the one you have purchased, call our toll free Consumer Assistance Center telephone number, **1-800-422-1230**.

Requesting Assistance or Service

If you need assistance or service in Canada:

1. If the problem is not due to one of the items listed in "Troubleshooting"† ...

Contact the dealer from whom you purchased your appliance, or call the KitchenAid Canada Consumer Assistance Centre toll free, **8:30 a.m. – 6 p.m. (EST)**, at **1-800-461-5681**.



2. If you need service† ...

Contact your nearest KitchenAid Canada Appliance Service branch or authorized servicing outlet to service your appliance. (See list below.)

† When asking for help or service: Please provide a detailed description of the problem, your appliance's complete model and serial numbers, and the purchase date. (See the "A Note to You" section.) This information will help us respond properly to your request.

KitchenAid Canada Appliance Service – Consumer Services

Direct service branches:

BRITISH COLUMBIA		1-800-665-6788
ALBERTA		1-800-661-6291
ONTARIO (except 807 area code)	Ottawa area Outside the Ottawa area	1-800-267-3456 1-800-807-6777
MANITOBA, SASKATCHEWAN and 807 area code in ONTARIO		1-800-665-1683
QUEBEC	Montreal (except South Shore) South Shore Montreal Quebec City Sherbrooke	1-800-361-3032 1-800-361-0950 1-800-463-1523 1-800-567-6966
ATLANTIC PROVINCES		1-800-565-1598

For further assistance

If you need further assistance, you can write to KitchenAid Canada with any questions or concerns at:

Consumer Relations Department
KitchenAid Canada
1901 Minnesota Court
Mississauga, Ontario L5N 3A7

Please include a daytime phone number in your correspondence.

Index

This index is alphabetical. It contains all the topics included in this manual, along with the page(s) on which you can find each topic.

<u>TOPIC</u>	<u>PAGE</u>	<u>TOPIC</u>	<u>PAGE</u>
ASSISTANCE	51, 52	LOCK	
BAKING		Control	7
Aluminum foil	17	Self-cleaning cycle	45, 47
Pans	17	MODEL AND SERIAL NUMBER	2
Setting cycle	15	OVEN DOOR	42
Tips	17, 18	OVEN TEMPERATURE	
BROILING		Adjusting	19
Grid	28	Setting	15, 16, 21, 25, 26, 29, 31, 34, 35, 38
Pan	28	OVEN VENT	39
Setting cycle	29	PARTS	5
Tips	32	RACKS	
CLEANING		Convection roasting rack	18
Broiler pan and grid	41	Placement	17
Control panel	40	Positions	14
Exterior surfaces	40, 41	RAISING (proofing) BREAD	39
Oven cavity	41	ROASTING	
Oven door glass	41	Rack	18
Oven racks	41	Setting cycle	16
Self-cleaning cycle	44	Tips	18
CONTROL PANEL		SAFETY	3-4
Canceling	7	SELF-CLEANING	
Celsius/Fahrenheit cooking	6	Delay cleaning	46
Clock	12	How cycle works	48
Command pads	6	Preparing oven	44
Control lock	7	Setting controls	45-47
Display	6	Starting immediately	45
Sabbath feature	8	Stopping cycle	47
Number pads	6	Tips	47
Prompt	7	SERVICE	51, 52
Settings	10, 11	TEMPERATURE PROBE	
Signals	7	Cleaning	23
Starting	7	Connecting to oven	21
Timer	13	Inserting in food	20
Tones	7	Setting cycle	21
CONVECT FULL MEAL	23	TIMED COOKING	
CONVECTION BAKING		Canceling	36
Pans	17	Cook time	34, 35
Setting	15	Stop time	36
Tips	17, 18	TROUBLESHOOTING	49
CONVECTION BROILING	31	WARRANTY	56
DEHYDRATING	37		
EASY CONVECT* Conversion	26		
FEATURES	5		
LIGHTS	43		

55

in the "Requesting Assistance or Service" section.

KitchenAid
Benton Harbor, Michigan 49022-2692 U.S.A.

KitchenAid^{*}

Electric Built-In Combination Microwave/Single Oven

Warranty

LENGTH OF WARRANTY:	KITCHENAID WILL PAY FOR:	KITCHENAID WILL NOT PAY FOR:
ONE-YEAR FULL WARRANTY FROM DATE OF INSTALLATION.	Replacement parts and repair labor costs to correct defects in materials or workmanship. Service must be provided by an authorized KitchenAid servicing outlet.	A. Service calls to: <ol style="list-style-type: none"> 1. Correct the installation of the oven. 2. Instruct you how to use the oven. 3. Replace house fuses or correct house wiring. B. Repairs when oven is used in other than normal home use.
SECOND-THROUGH FIFTH-YEAR LIMITED WARRANTY FROM DATE OF INSTALLATION.	Replacement microwave magnetron or any oven electric element to correct defects in materials or workmanship. Replacement parts for solid state touch control system to correct defects in materials or workmanship.	C. Damage resulting from accident, alteration, misuse, abuse, improper installation, or installation not in accordance with local electrical codes. D. Any labor costs during the limited warranties. E. Replacement parts or repair labor costs for units operated outside the United States.
SECOND-THROUGH TENTH-YEAR LIMITED WARRANTY FROM DATE OF INSTALLATION.	Replacement parts for the porcelain oven cavity/inner door if the part rusts through due to defects in materials or workmanship.	F. Pickup and delivery. This product is designed to be repaired in the home. G. Repairs to parts or systems caused by unauthorized modifications made to the appliance.

3/96

KITCHENAID AND KITCHENAID CANADA DO NOT ASSUME ANY RESPONSIBILITY FOR INCIDENTAL OR CONSEQUENTIAL DAMAGES. Some states or provinces do not allow the exclusion or limitation of incidental or consequential damages, so this exclusion or limitation may not apply to you. This warranty gives specific legal rights and you may also have other rights which vary from state to state or province to province.

Outside the United States and Canada, a different warranty may apply. For details, please contact your authorized KitchenAid dealer.

If you need assistance or service, first see the "Troubleshooting" section of this book. After checking "Troubleshooting," additional help can be found by checking the "Requesting Assistance or Service" section. In the U.S.A., call our Consumer Assistance Center at **1-800-422-1230**. In Canada, call KitchenAid Canada at one of the telephone numbers listed in the "Requesting Assistance or Service" section.

KitchenAid
Benton Harbor, Michigan 49022-2692 U.S.A.

PART NO. 4451399
© 1997 KitchenAid

* Registered trademark/Trademark of KitchenAid, U.S.A.,
KitchenAid Canada licensee in Canada.

4/97
Printed in U.S.A.