

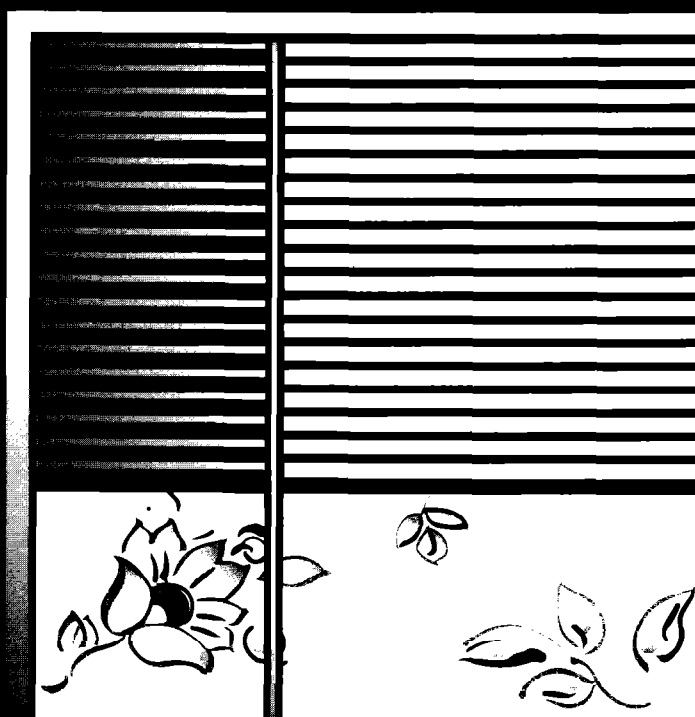

Owner's

M A N U A L

COOL IMPRESSION



A Note to You	2
Important Safety Instructions	3
Parts and Features	4
Operating Your Air Conditioner	5
Personalizing the Front Panel	8
Caring for Your Air Conditioner	9
Installing Your Air Conditioner	12
Troubleshooting	16
Obtaining Service	16

ROOM AIR CONDITIONERS

A Note to You

Thank you for buying a high quality, world-class home appliance.

You have purchased a quality, *world-class* home appliance. Years of engineering experience went into its manufacture. To ensure you operate and care for your appliance properly, we developed this Owner's Manual. It is full of valuable information on how to operate and maintain your appliance properly and safely. Please read it carefully.

Your safety is important to us.

This guide contains safety symbols and statements. Please pay special attention to these symbols and follow any instructions given. Here is a brief explanation of the use of each symbol.

⚠ WARNING

This symbol alerts you to such dangers as personal injury, burns, fire, and electrical shock.

 **15 A** This symbol represents the rated current of appropriate fuse-link in amperes.

 This symbol represents the **EARTHING TERMINAL**.

Please complete this section.

If you ever have a question concerning this appliance, or if you need service, first see "Obtaining Service" on page 16. If service is required, you will need to know your appliance's complete model and serial number. You can find this information on the model and serial number label (see diagram on page 4). For your convenience, we included a place below for you to record these numbers, the purchase date from the sales slip, and your dealer's name and telephone number. Keep this book and the sales slip together in a safe place for future reference.

Model Number _____ **Dealer Name** _____
Serial Number _____ **Dealer Phone** _____
Purchase Date _____

IMPORTANT: After turning the unit off, wait approximately 3 minutes before turning it back on. If you don't wait 3 minutes, the air conditioner will try to start, but turn itself off.

Important Safety Instructions

⚠ WARNING

To reduce the risk of fire, electrical shock, or personal injury when using your air conditioner, follow these basic safety precautions:

- Read all instructions before using your air conditioner.
- Complete the installation requirements as described in "Installing Your Air Conditioner" on pages 12-15.
- Do not allow children to operate or play with the air conditioner.
- Do not use an extension cord with this or any other appliance.
- Plug the air conditioner into a grounded electrical outlet only.
- Do not operate the air conditioner with the front panel removed.
- Never clean air conditioner parts with flammable fluids. The fumes can create a fire hazard or explosion.

• FOR YOUR SAFETY •

DO NOT STORE OR USE GASOLINE OR OTHER FLAMMABLE VAPOURS AND LIQUIDS IN THE VICINITY OF THIS OR ANY OTHER APPLIANCE. THE FUMES CAN CREATE A FIRE HAZARD OR EXPLOSION.

– SAVE THESE INSTRUCTIONS –

Consumer responsibilities

Please:

- The steps on pages 12-15 must be performed by a qualified installer.
- Be sure the air conditioner is the correct voltage and size for the area you want to cool.
- Be sure the air conditioner is installed in accordance with all national electrical codes and wiring regulations.
- Use the air conditioner only for the uses described in this manual.
- Be sure the air conditioner is not used by anyone unable to operate it properly.
- Maintain the air conditioner properly.
- If power cord is damaged, be sure it is replaced or repaired by an authorized service technician.

Also, please DO NOT use sharp instruments, flammable fluids, or abrasive cleaners. These can damage the surface of the air conditioner.

Parts and Features

This section contains captioned illustrations of your air conditioner. Please use them to become familiar with where the parts and features are located and what they look like.

Air conditioner

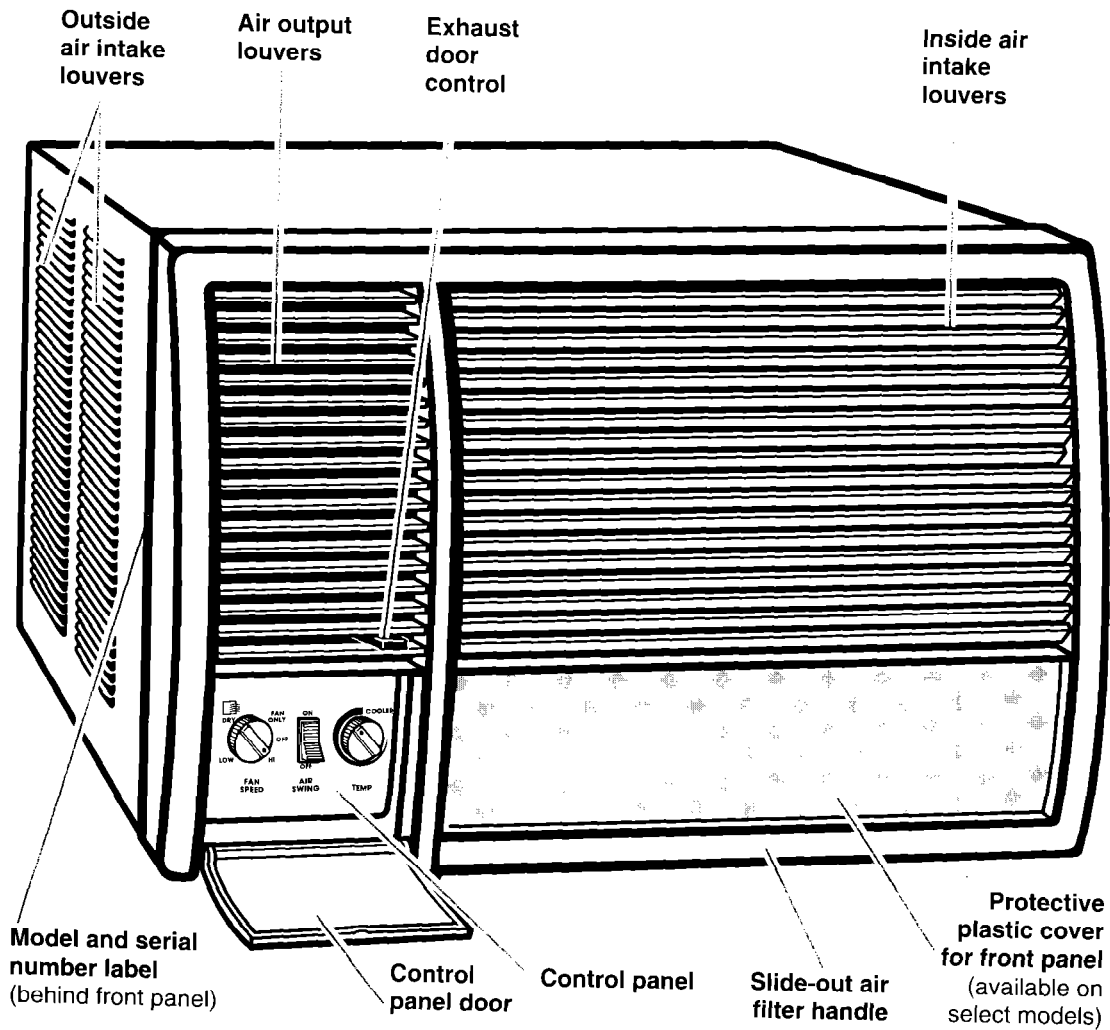

Operating Your Air Conditioner

In This Section		Page	Page
Turning the air conditioner on/off	Using the FAN ONLY Cycle	6	6
Modifying the fan speed	Activating the AIR SWING Option	6	6
Modifying the temperature	Modifying the air direction	7	7
Using the DRY Cycle	Using the exhaust door	7	7

Operating your air conditioner properly is essential to obtain the best possible results. This section tells you about each cycle and how to operate it.

Turning the air conditioner on/off

To turn the air conditioner on:

- Turn the FAN SPEED Control to a setting other than OFF.

To turn the air conditioner off:

- Turn the FAN SPEED Control to the OFF setting.

IMPORTANT: After turning the unit off, wait approximately 3 minutes before turning it back on. If you don't wait 3 minutes, the air conditioner will try to start, but turn itself off.

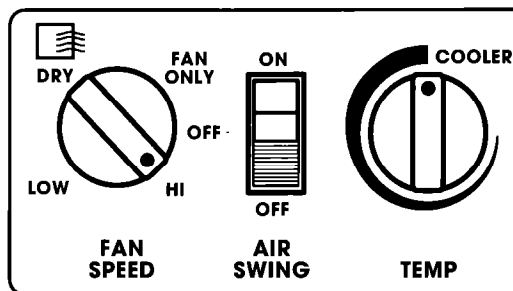

Modifying the fan speed

Use the FAN SPEED Control to select a desired fan speed. Use the speeds as follows:

HI Speed –

Use for maximum cooling.

LOW Speed –

Use for sleeping comfort.

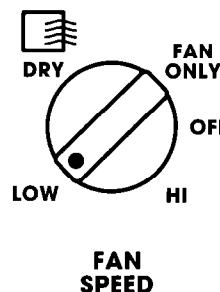

Modifying the temperature

Set the TEMP Control to your desired setting.

- Turn clockwise for more cooling.
- Turn counterclockwise for less cooling.

You will need to experiment to find the setting which suits you best.

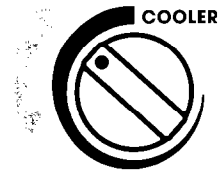

Using the DRY Cycle

The DRY Cycle causes your air conditioner to act like a dehumidifier. During the cycle, the air conditioner removes excess moisture from the room air without providing any cooling.

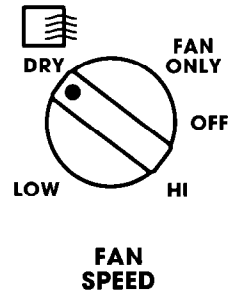

Using the FAN ONLY Cycle

The FAN ONLY Cycle circulates the room air without cooling it. It will also exhaust stale room air if you open the exhaust door.

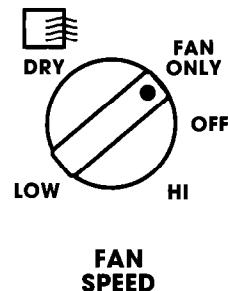

Activating the AIR SWING Option

Use the AIR SWING Control to direct the flow of the cooled air to the left or the right. Turning the AIR SWING Control off causes the air to flow in whatever direction the air louvers are pointing at the time.

To activate air swing:

- Set the switch in the ON position.

To deactivate the air swing:

- Set the switch in the OFF position.



Adjusting the direction

The air output louvers, at the left side of the air conditioner's front panel, control the direction of the cooled air. The louvers may be adjusted up or down. To adjust the air left or right, you must activate the Air Swing feature.

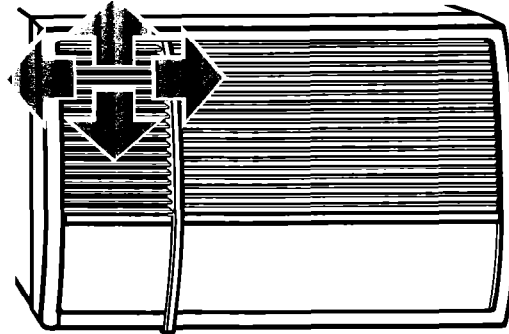

To activate the AIR SWING feature:
Set the AIR SWING Switch to ON.

To deactivate the AIR SWING feature:
Set the AIR SWING Switch to OFF.

Using the exhaust door

The exhaust door allows the air conditioner to draw stale or smoky air from the room. Pull to open exhaust door or push to close.

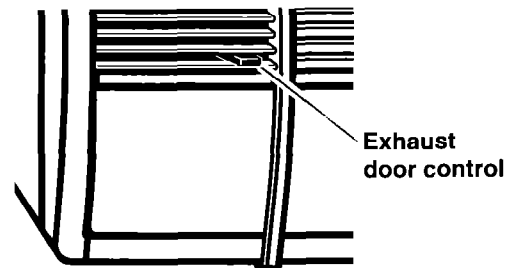

Personalizing the Front Panel

(available on select models)

The appearance of the front panel can be customized to suit your tastes or to match the room. The panel has two clear, protective plastic covers that you can remove. Then, place wallpaper, fabric, pictures, etc., in the open areas and replace the protective covers.

Removing the protective covers

1. Place the flat edge of a screwdriver into the 1 mm gap between the protective cover and the front panel.
2. Carefully pry off the protective cover.
3. Repeat for second protective cover.

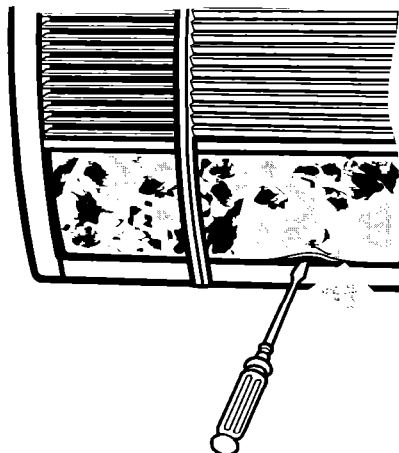

Replacing the protective covers

1. Insert tabs on one side of the protective cover into the tabs in the corresponding side of the front panel.
2. Snap the other side of the cover into place.
3. Repeat for second protective cover.

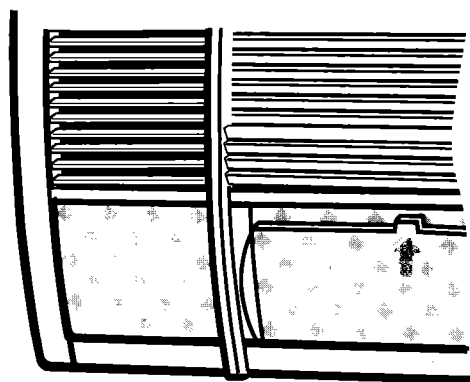

Caring for Your Air Conditioner

In This Section		Page	Page
Caring for the control panel		Caring for the slide-out air filter	10
Caring for the front panel, etc.		Performing annual coil cleaning	11

Proper maintenance of your air conditioner ensures longer life and lower operating costs. This section tells you how to clean your air conditioner and perform general maintenance. You can always call an authorized Whirlpool* service company for annual service.

Caring for the control panel

Wipe clean with a soft, damp cloth. Make sure the cloth is not dripping wet.

The control panel door

If the control panel door pops out of place, it pops back into place easily.

- 1 Place the left door pin into the hole on the left side of the door opening.
- 2 Flex the door slightly.
- 3 Snap the right door pin into place.

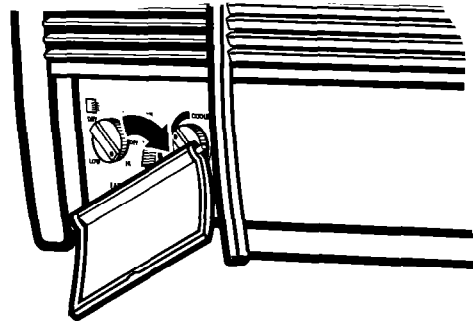

Caring for the front panel, etc.

Perform basic cleaning of the front panel by wiping it with a soft, dry cloth.

NOTE: Do not use abrasive or harsh cleaners on the front panel, especially on the protective plastic cover.

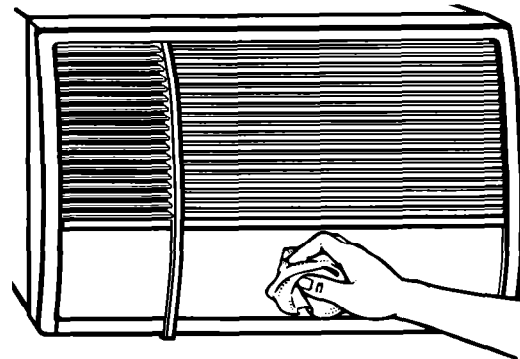

Caring for the slide-out air filter

The air filter helps remove dust, lint, and other particles from the air. The air filter is cleanable. Check the air filter every few weeks to see if it needs cleaning.

1. Grasp the bottom edge of the front panel with both hands, as shown. There are 2 finger notches in the front panel – behind the filter handle.
2. Slide the air filter forward and down until it releases from the front panel.
3. Clean the air filter using a vacuum cleaner.

OR

If it is very dirty, wash the filter with warm water and a mild detergent.

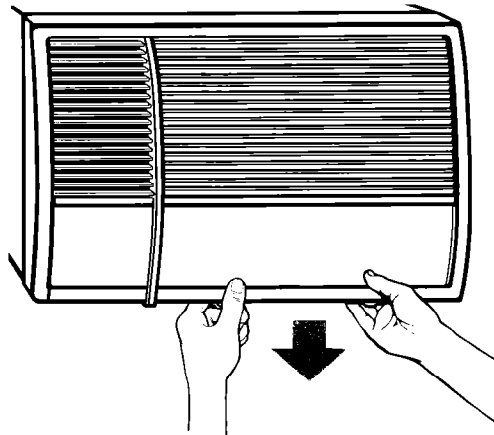

4. Slide filter up into the slot until filter is completely fitted.

NOTE: You may need to clean the air filter more often if it is subjected to heavy dust, dirt, etc.

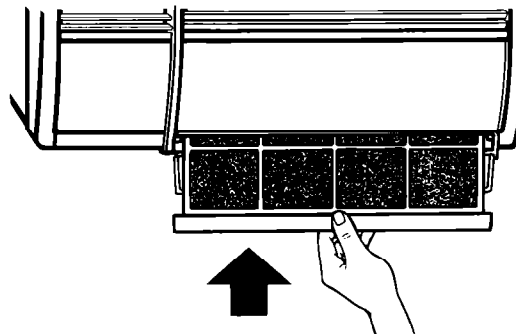

Performing annual coil cleaning

The coils in your air conditioner need to be cleaned annually to prolong the air conditioner's life and its cooling efficiency. As air moves over the coils, they collect dirt, sand, leaves, insects, algae, and other airborne particles.

Contact an authorized service company to perform this annual maintenance.

Installing Your Air Conditioner

In This Section	Page	Page
General information		Installation procedure

General information

Location

Your air conditioner will work well in any location. However, the preferred location for the unit is on a wall out of direct sunlight. The location should also provide:

- Adequate support for the weight of the unit.
- An electrical outlet within reach of the power supply cord.
- Free movement of air to the room(s) to be cooled.
- Free movement of air to the air intake louvers (inside and outside).

The power supply cord can be fed through either side of the front panel.

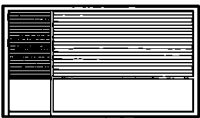

Electrical outlet must be available within reach of the power supply cord. **DO NOT** use an extension cord.

Clearance

- Keep outside air intake louvers clear.

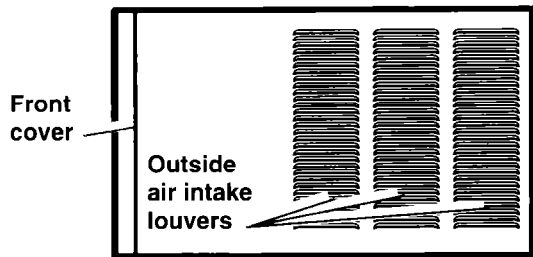

- If the wall is too thick, cut the wall back on a 45° angle if possible.

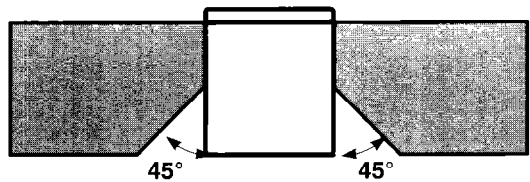

- Allow sufficient clearance around the sides and rear of the unit.

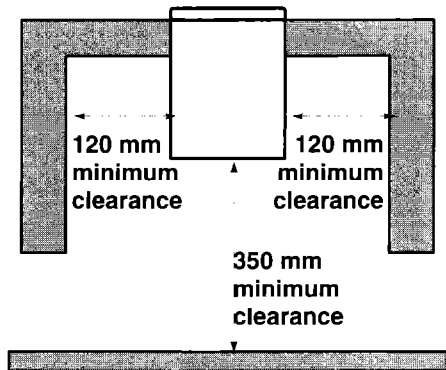

Provide adequate drainage.

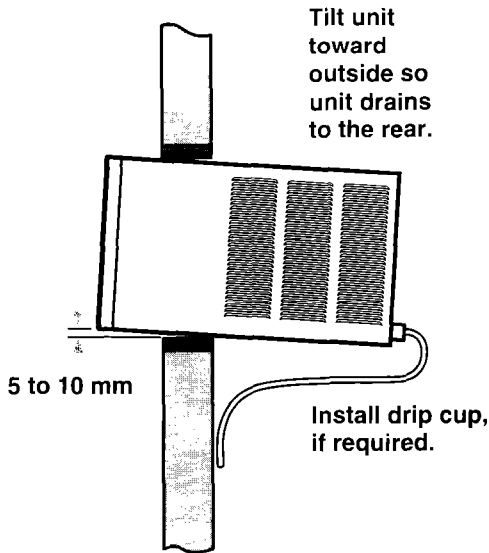

- Provide additional support for unit if required.

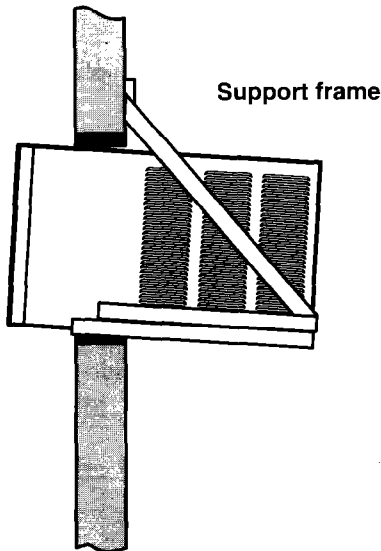

- Provide adequate clearance so the air filter can be removed from the bottom of the front panel.

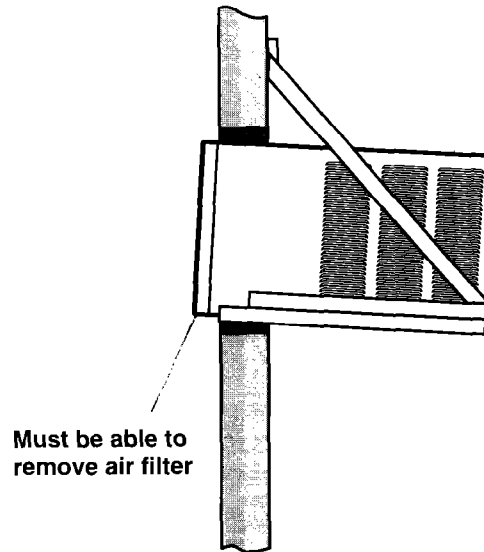

Electrical requirements

Check the model and serial number label to determine the electrical requirements of your unit. ALL units must use a time delay fuse or circuit breaker.

Grounding method

Your air conditioner is equipped with a power supply cord containing a 3-prong grounding plug. To minimize possible electrical shock hazard, the power supply cord must be plugged into a mating 3-prong, grounding-type wall receptacle, which is grounded in accordance with all applicable codes. If a mating wall receptacle is not available, it is the personal responsibility and obligation of the customer to have a properly grounded 3-prong wall receptacle installed by a qualified electrician.

Power supply

DO NOT disconnect the air conditioner from its electrical supply. DO NOT use an electrical outlet that can be turned off with a switch.

Installation procedure

1. Remove the front panel. Remove tape (if any). Lift panel and take it off the cabinet.

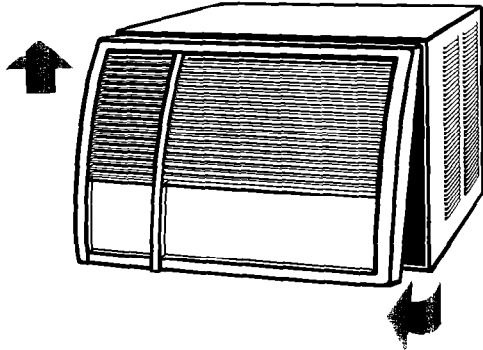

1. Slide the chassis out of the cabinet.

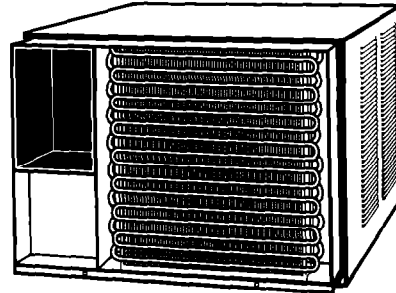

2. Remove the shipping brackets (2). Remove the cabinet ground screw (1) and disconnect the green and yellow grounding wire.

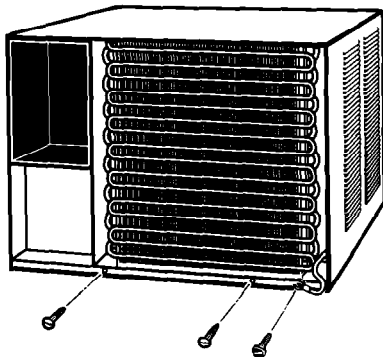

5. Install the drain plug and drain cup (accessory parts) to rear of cabinet. Slide drain cup down into rear support between grooves in cup.
NOTE: Attach drain plug and drain cup assemblies and attach hose before sliding unit into cabinet.

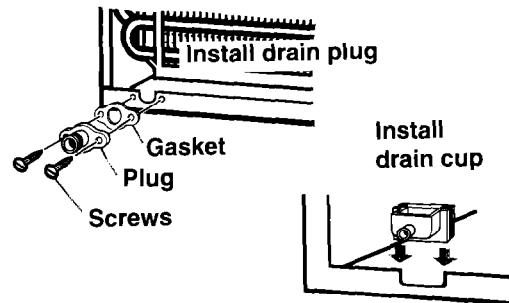

3. Remove the rear shipping screws (2).

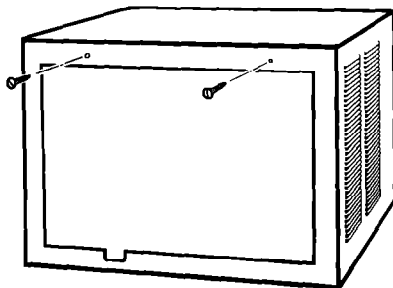

6. Fix the cabinet to the support frame.

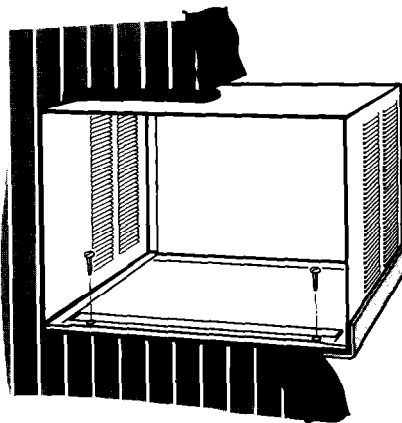

Slide the chassis into the cabinet. Install the cabinet seal (accessory part) between the cabinet and the frame/wall.

Cabinet seal

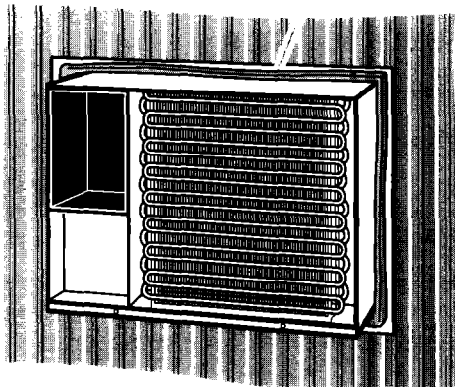

8. Reinstall the shipping bracket and attach with screws (2).

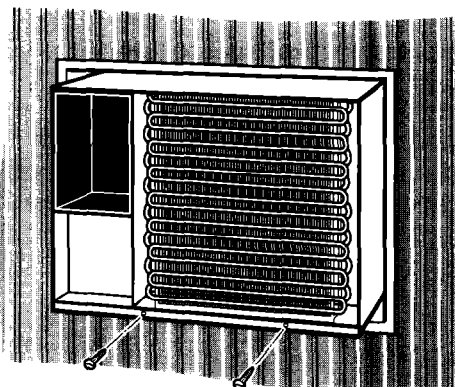

9. Reconnect the green and yellow grounding wire.

⚠ WARNING

Electrical Shock Hazard

Connect ground wire when unit is in cabinet.

Failure to do so will result in electrical shock.

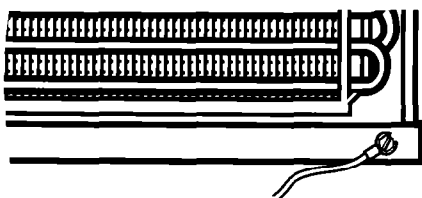

10. Remove slide-out filter from front panel. Replace the front panel. Insert tabs into slots on the top flange of the cabinet. Rotate the front panel downward until it fits snugly between cabinet side flanges. Secure front panel with 2 screws (accessory parts). Replace slide-out air filter.

NOTE: Make sure the Exhaust Door Control lever is between the frame and the first air discharge louver before securing front panel with screws.

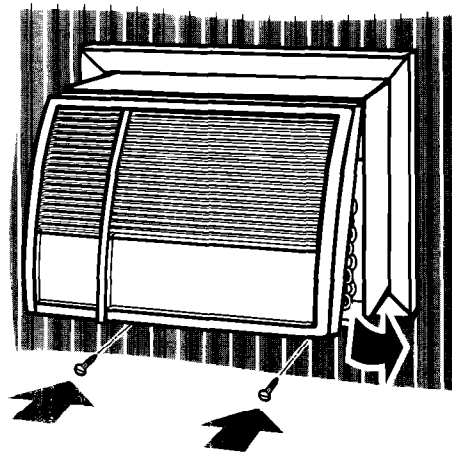

Troubleshooting

Performance problems often result from little things you can find and fix yourself, without tools of any kind. Check the chart below for problems you can fix. It could save you the cost of a service call.

PROBLEM	POSSIBLE SOLUTION
Unit won't run	Make sure unit is plugged into a live circuit with proper voltage. Check if a household fuse has blown or the circuit breaker tripped. Make sure unit is turned on. See if the local power has failed. Wait at least 3 minutes after turning unit off before trying to restart.
Unit blows household fuses or trips circuit breakers	Check if a household fuse has blown or the circuit breaker tripped. Make sure an extension cord is not being used. Make sure unit is plugged into a live circuit with proper voltage. Wait at least 3 minutes after turning unit off before trying to restart.
Remote control doesn't work	Replace batteries. If the remote control still doesn't work, call your authorized service company.
Unit stops/starts unexpectedly	(Deluxe Remote Control models only.) Check if Delay Start or Delay Stop is programmed. See Deluxe Remote Control Owner's Manual for more information on these TIMED MODE operations.

Obtaining Service

If the problem is not due to an item listed in the chart above ...

Contact the dealer from whom you purchased the unit, an authorized Whirlpool* service company, or refer to the guarantee booklet included with your product.