

Owner's Manual and Installation Instructions

Galaxy™

One-Speed AUTOMATIC WASHER

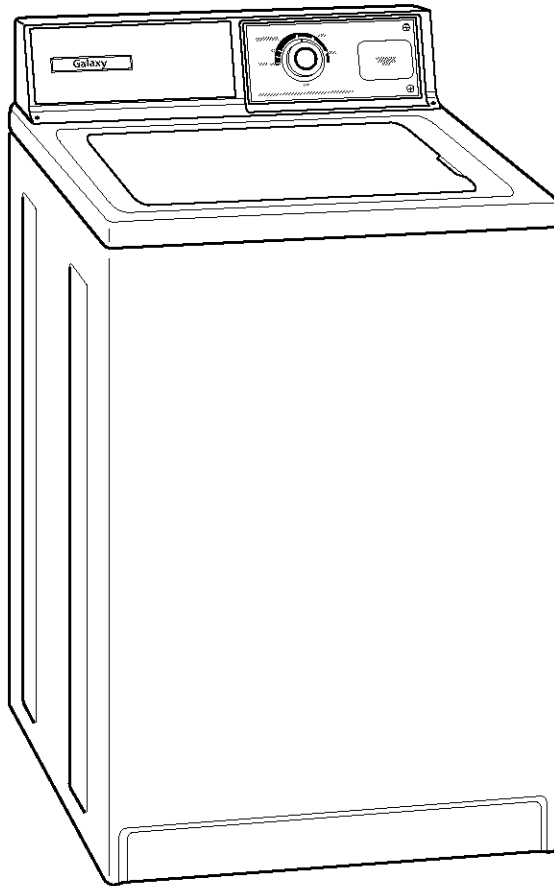

ENGLISH

IMPORTANT:

Read and follow all safety
and operating instructions
before first use of this product.

Sears, Roebuck and Co., Hoffman Estates, IL 60179 U.S.A.
Sears Canada Inc., Toronto, Ontario, Canada M5B 2B8

www.sears.com

3953624

PRINTED IN U.S.A.

3/99

TABLE OF CONTENTS

BEFORE USING YOUR NEW WASHER 2

GALAXY™ AUTOMATIC WASHER WARRANTY 3

WASHER SAFETY 4

INSTALLATION INSTRUCTIONS 6

OPERATING YOUR WASHER 21

CARING FOR YOUR WASHER 24

TROUBLESHOOTING 25

SEARS MAINTENANCE AGREEMENT 29

BEFORE USING YOUR NEW WASHER

Please read this manual. It will help you install and operate your new automatic washer in the safest and most economical way.

For more information about the care and operation of Galaxy™ appliances, call your nearest Sears store. You will need the complete model and serial numbers when requesting information. Your washer's model and serial numbers are located on the Model and Serial Number Plate.

Use the space below to record the model number and serial number of your new washer.

Model No. _____

Serial No. _____

Date of Purchase _____

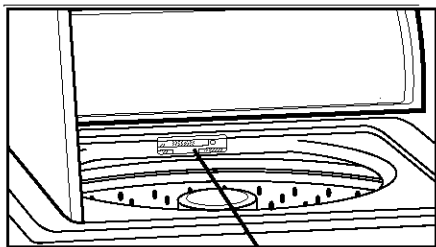

Model and Serial Number Plate

Keep this book and your Sears Salescheck (receipt) in a safe place for future reference.

GALAXY™ AUTOMATIC WASHER WARRANTY

90-DAY WARRANTY ON MECHANICAL AND ELECTRICAL PARTS

For ninety days from the date of purchase, when the washer is installed and operated in accordance with the instructions in the Owner's Manual, Sears will repair or replace any mechanical or electrical parts in this washer, if defective in material or workmanship.

LIMITED 2-YEAR WARRANTY ON GEARCASE PARTS*

After ninety days and until two years from the date of purchase, Sears will furnish replacement parts for any defective gearcase parts. You will be charged for labor.

LIMITED 5-YEAR WARRANTY ON PLASTIC TUB*

After ninety days and until five years from date of purchase, Sears will furnish a replacement plastic tub for any plastic tub which is defective in material or workmanship. You will be charged for labor.

If the washer is subjected to other than private family use, the above warranty coverage is effective for only 90 days.

WARRANTY SERVICE IS AVAILABLE BY CONTACTING THE NEAREST SEARS SERVICE CENTER IN THE UNITED STATES OR CANADA.

This warranty applies only while this product is in use in the United States or Canada. This warranty gives you specific legal rights, and you may have other rights which vary from state to state or province to province.

**Sears Roebuck and Co., Dept. 817WA, Hoffman Estates, IL 60179 U.S.A.
Sears Canada Inc., Toronto, Ontario M5B 2B8**

*In Canada, a different warranty may apply. For warranty information, contact Sears Canada Inc., at 1-800-469-4663.

ENGLISH

WASHER SAFETY

Your safety and the safety of others is very important.

We have provided many important safety messages in this manual and on your appliance. Always read and obey all safety messages.



This is the safety alert symbol. This symbol alerts you to hazards that can kill or hurt you and others. All safety messages will be preceded by the safety alert symbol and the word "DANGER" or "WARNING." These words mean:

⚠ DANGER

You will be killed or seriously injured if you don't follow instructions.

⚠ WARNING

You can be killed or seriously injured if you don't follow instructions.

All safety messages will identify the hazard, tell you how to reduce the chance of injury, and tell you what can happen if the instructions are not followed.

IMPORTANT SAFETY INSTRUCTIONS

WARNING: To reduce the risk of fire, electric shock, or injury to persons when using your washer, follow basic precautions, including the following:

- Read all instructions before using the washer.
- Do not wash articles that have been previously cleaned in, washed in, soaked in, or spotted with gasoline, dry-cleaning solvents, other flammable or explosive substances as they give off vapors that could ignite or explode.
- Do not add gasoline, dry-cleaning solvents, or other flammable or explosive substances to the wash water. These substances give off vapors that could ignite or explode.
- Under certain conditions, hydrogen gas may be produced in a hot water system that has not been used for 2 weeks or more. **HYDROGEN GAS IS EXPLOSIVE.** If the hot water system has not been used for such a period, before using a washing machine, turn on all hot water faucets and let the water flow from each for several minutes. This will release any accumulated hydrogen gas. As the gas is flammable, do not smoke or use an open flame during this time.
- Do not allow children to play on or in the washer. Close supervision of children is necessary when the washer is used near children.
- Before the washer is removed from service or discarded, remove the lid.
- Do not reach into the washer if the tub or agitator is moving.
- Do not install or store this washer where it will be exposed to the weather.
- Do not tamper with controls.
- Do not repair or replace any part of the washer or attempt any servicing unless specifically recommended in the Owner's Manual or in published user-repair instructions that you understand and have the skills to carry out.
- See Installation Instructions for grounding requirements.

SAVE THESE INSTRUCTIONS

IMPORTANT: Observe all governing codes and ordinances.

ENGLISH

INSTALLATION INSTRUCTIONS

INSTALLATION OVERVIEW

For a complete list of tools and parts needed, see pages 7-9.

A. SELECT LOCATION FOR YOUR WASHER (pgs. 11-13)

Recessed Area/
Closet Installation Instructions (p. 11)

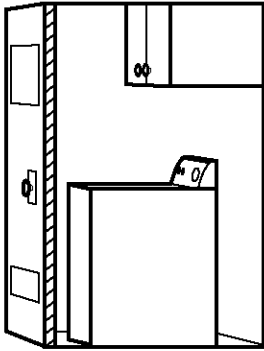

Laundry Tub Drain System (p. 12)

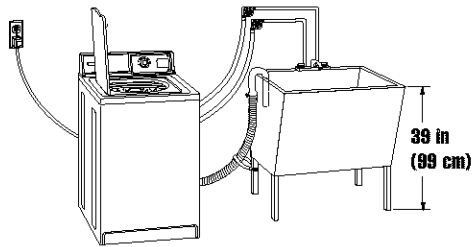

Standpipe Drain System (p. 13)

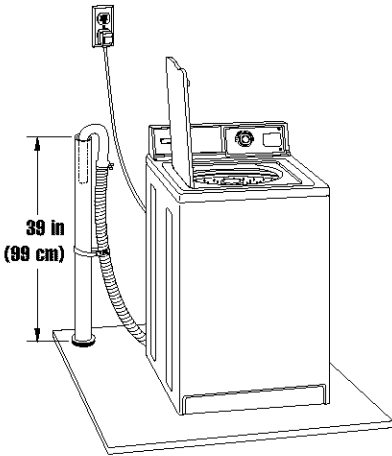

Floor Drain System (p. 13)

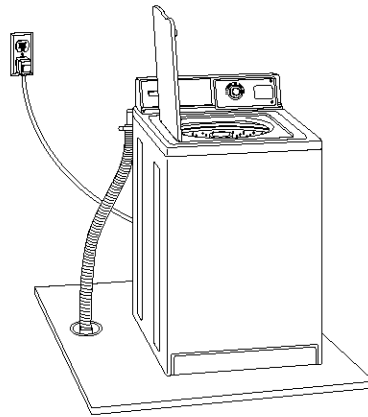

B. REMOVE SHIPPING STRAP (p. 14)

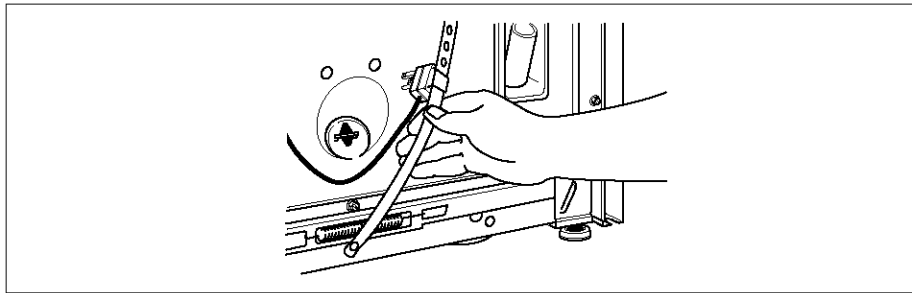

Tools Needed:

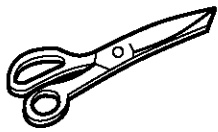

Scissors

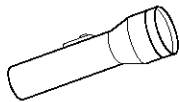

Flashlight (optional depending on installation)

C. CONNECT DRAIN HOSE (pgs. 15-16)

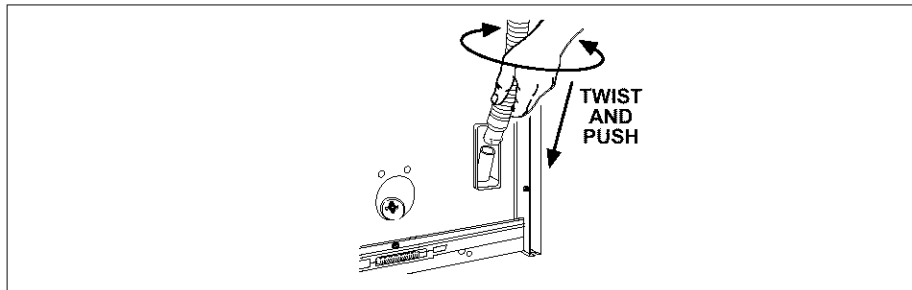

Tools Needed:

Parts Needed:

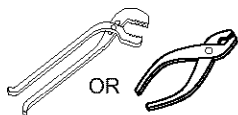

Pliers that open to 1 $\frac{1}{8}$ in (3.95 cm)

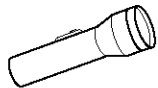

Flashlight (optional depending on installation)

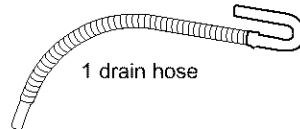

1 drain hose



1 yellow, single-wire hose clamp (top of drain hose)



1 silver, double-wire hose clamp (bottom of drain hose)

ENGLISH

D. CONNECT INLET HOSES TO WASHER (pgs. 16-17)

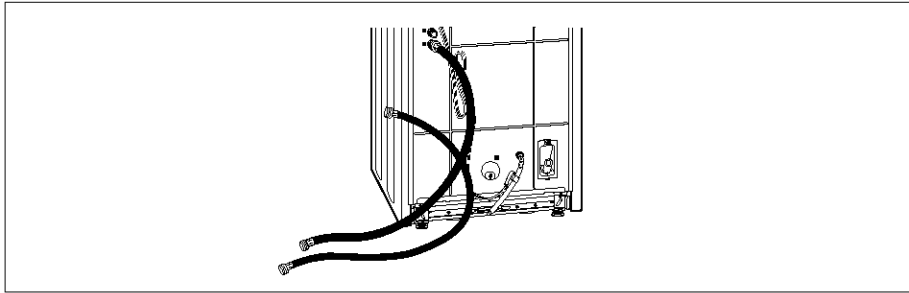

Tools Needed:

Parts Needed:

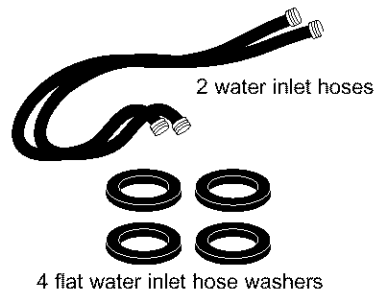
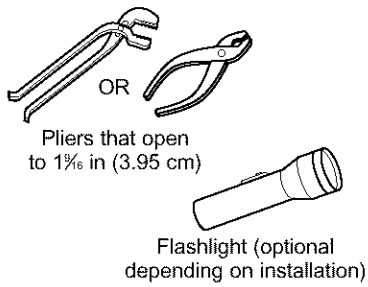

E. CONNECT INLET HOSES TO WATER FAUCETS (p. 17)

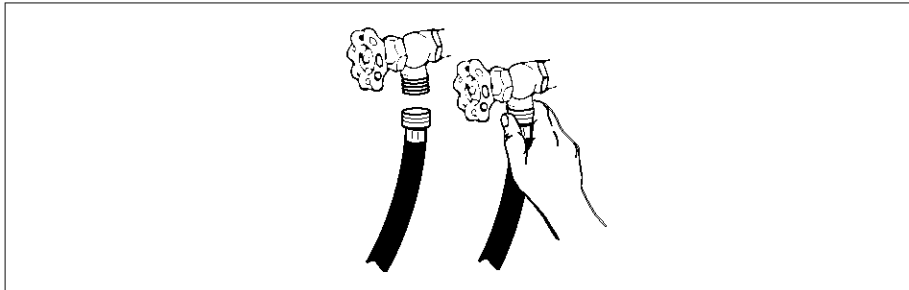

Tools Needed:

Parts Needed:

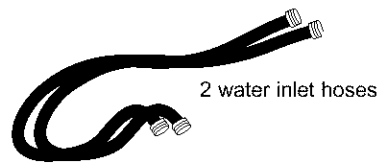
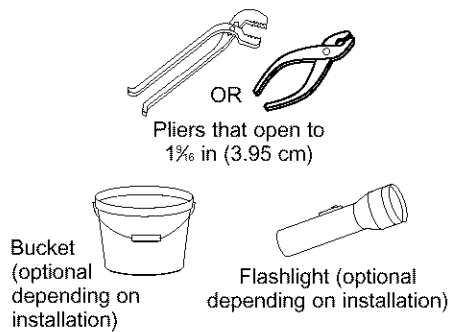

F. SECURE DRAIN HOSE (p. 18)

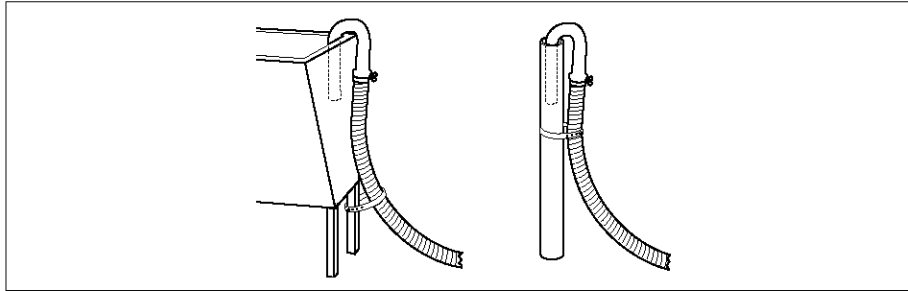

Tools Needed:



Parts Needed:

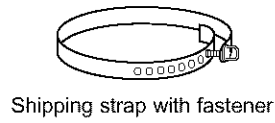

G. LEVEL WASHER (p. 19)

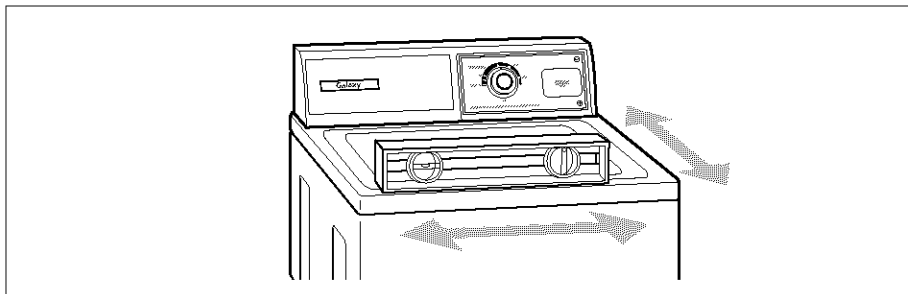

Tools Needed:

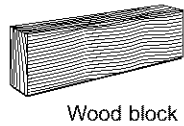
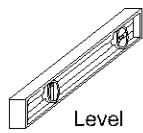
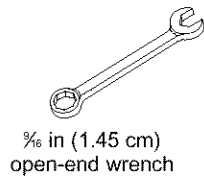

Parts Needed:

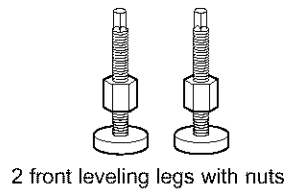

ENGLISH

for your Benefit

Selecting the proper location for your washer will improve its performance and minimize concerns like washer walk or noise.

ELECTRICAL REQUIREMENTS

120-Volt, 60-Hz., AC-only, 15- or 20-ampere fused electrical supply is required. (Time-delay fuse or circuit breaker is recommended.) Connect to individual branch circuit.

⚠ WARNING



Electrical Shock Hazard

Plug into a grounded 3 prong outlet.
Do not remove ground prong.
Do not use an adapter.
Do not use an extension cord.
Failure to follow these instructions can result in death, fire, or electrical shock.

GROUNDING INSTRUCTIONS

WARNING: Improper connection of the equipment grounding conductor can result in a risk of electric shock. Check with a qualified electrician or serviceman if you are in doubt as to whether the appliance is properly grounded. Do not modify the plug provided with the appliance – if it will not fit the outlet, have a proper outlet installed by a qualified electrician.

For your personal safety, this washer must be grounded. In the event of malfunction or breakdown, grounding will reduce the risk of electric shock by providing a path of least resistance for electric current.

This washer is equipped with a power supply cord having a 3 prong grounding plug. To minimize possible shock hazard, you must plug the power supply cord into a mating 3 prong grounding-type wall receptacle, grounded in accordance with National Electrical Code, ANSI/NFPA 70-latest edition and all local codes and ordinances.

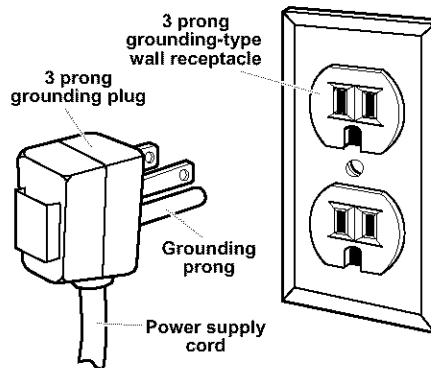

**A. SELECT LOCATION
FOR YOUR WASHER –**

**RECESSED AREA/
CLOSET INSTALLATION INSTRUCTIONS**

This washer may be installed in a recessed area or closet.

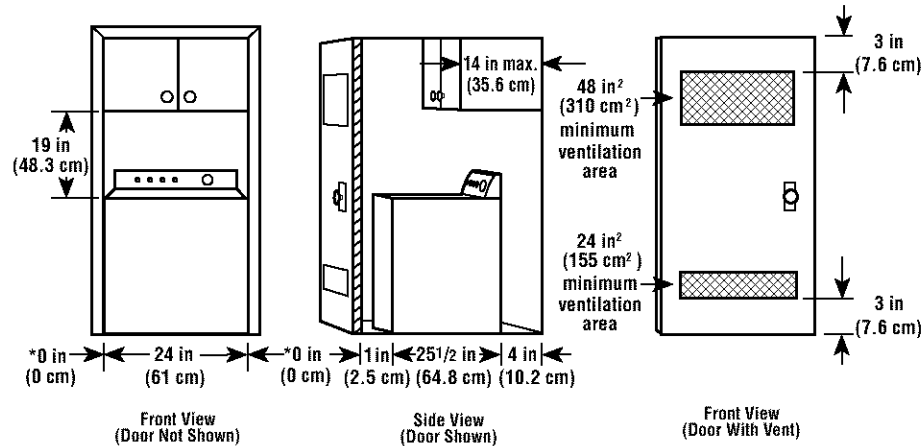

*Additional clearance for wall, door and floor moldings may be required.
To reduce transfer of washer sounds, a clearance of 1 in (2.5 cm) on the sides of the washer is recommended.

- The installation spacing is in inches (centimeters) and is the minimum allowable.
- Allow additional space if other appliances are to be installed in the area.
- If closet door is installed, the minimum air openings in top and bottom are required. Louvered doors with equivalent air openings in top and bottom are acceptable.

ENGLISH

LAUNDRY TUB DRAIN SYSTEM

Check location where washer will be installed. This washer can be installed using one of three systems:

- Laundry tub drain system (below)
- Standpipe drain system (p. 13)
- Floor drain system (p. 13)

Do not store or operate washer at or below 32°F (0°C) (some water may remain in washer). See page 24 for winterizing information.

Proper installation is your responsibility. Make sure you have everything necessary for correct installation including the following points:

Grounded receptacle: Must be within 4 ft (1.2 m) of where the power cord is attached to the back of the washer.

Hot and cold water faucets: Must provide water pressure between 5-100 psi and be within 4 ft (1.2 m) of the hot and cold water fill valves attached to the back of the washer.

Laundry tub drain system: Needs a minimum 20 gal (76 L) laundry tub.

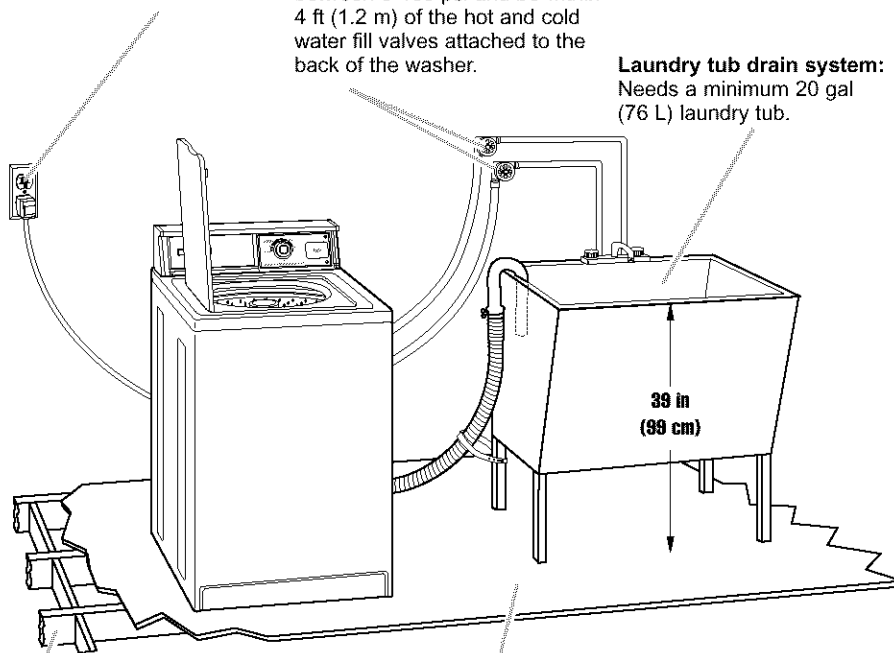

Support: Floor must be sturdy enough to support a total weight of 315 lbs (143 kg) (including washer, water, and load weight).

Level floor: Maximum allowable slope under entire washer – 1 in (2.5 cm)

Top of tub must be at least 39 in (99 cm) above floor and no higher than 96 in (2.4 m) from bottom of washer.

**ALTERNATE LOCATIONS –
STANDPIPE AND FLOOR DRAIN SYSTEMS**

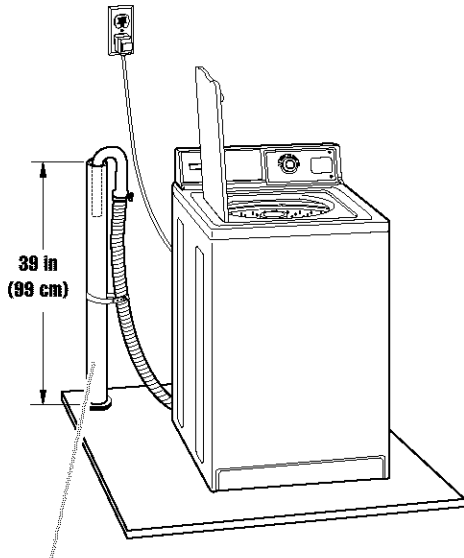

Standpipe drain system: Needs a 2 in (5 cm) minimum diameter standpipe with minimum carry-away capacity of 17 gal (64 L) per minute. Top of standpipe must be at least 39 in (99 cm) above floor and no higher than 96 in (2.4 m) from bottom of washer.

Siphon break: Must be purchased separately. See chart below.

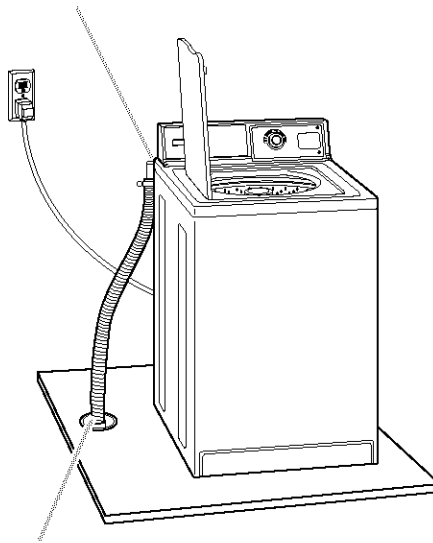

Floor drain system: Requires a siphon break, see chart below. A minimum carry-away capacity of 17 gal (64 L) per minute is required.

ENGLISH

| If you have: | You will need to buy: |
|--|--|
| Laundry tub or standpipe taller than 96 in (2.4 m) | Sump pump system (if not already available) |
| 1 in (2.5 cm) diameter standpipe | 2 in (5 cm) diameter to 1 in (2.5 cm) diameter standpipe adapter, Part No. 3363920 |
| Overhead sewer | Standard 20 gal (76 L), 39 in (99 cm) tall drain tub or utility sink and sump pump (available from local plumbing suppliers) |
| Floor drain | Siphon break, Part No. 285320; additional drain hose, Part No. 3357090; and Connector Kit, Part No. 285442 |

Parts listed are available from your local Sears store or Sears Service Center. In the United States, call 1-800-366-PART (1-800-366-7278). In Canada, call 1-800-469-4663.

B. REMOVE SHIPPING STRAP

for your Benefit

Removing the shipping strap is necessary for smooth operation. If the shipping strap is not removed, the washer will make excessive noise.

⚠ WARNING

Excessive Weight Hazard

Use two or more people to move and install washer.

Failure to do so can result in back or other injury.

To prevent floor damage, set washer onto cardboard before moving across floor. Move washer close to its final location.

STEP 1. Read, then remove the label over the electrical plug and shipping strap.

STEP 2. Pull the yellow shipping strap completely out of the washer. Depending on your model, there will be either two or three cotter pins on the end of the shipping strap when it is pulled out of the washer. The electrical plug is attached to this shipping strap.

Electrical plug

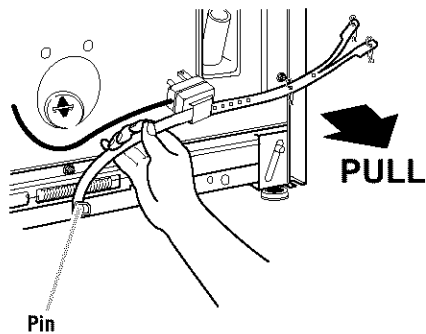
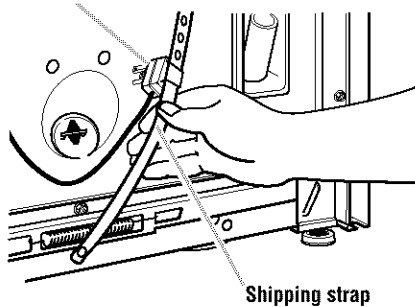

STEP 3. Pull firmly to remove the other end of the shipping strap pinned to the back of washer. This will release the rear self-leveling legs.

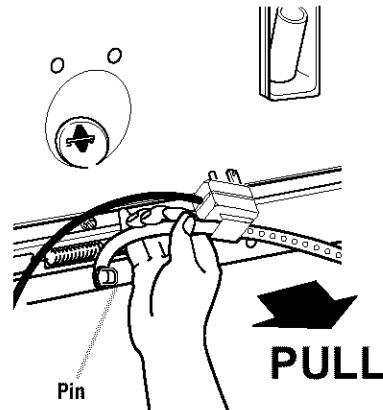

STEP 4. Cut the shipping strap about 16 in (40 cm) from plug end. Look for the words "CUT HERE." Discard end with the cotter pins. **Slide remainder of shipping strap free from the electrical plug.** You will use this to secure the drain hose.

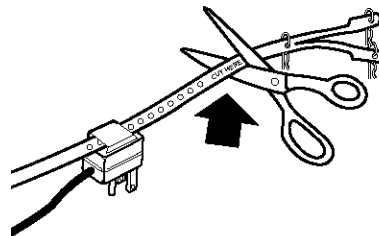
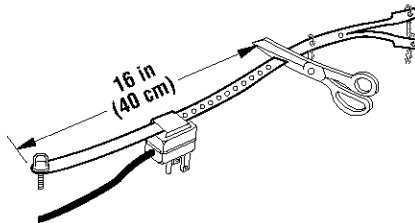

C. CONNECT DRAIN HOSE

for your Benefit

Proper connection of the drain hose will protect your floors from damage due to water leakage.

STEP 1. To prevent the drain hose from coming off or leaking, it must be installed per the following instructions:

IMPORTANT: To ensure proper installation, this procedure must be followed exactly.

- a. Wet the inside of the straight end of the drain hose with tap water. **DO NOT USE ANY OTHER LUBRICANT.**
- b. Squeeze ears of silver, double-wire clamp with pliers to open. Place clamp over the straight end of the drain hose $\frac{1}{4}$ in (6 mm) from the end.

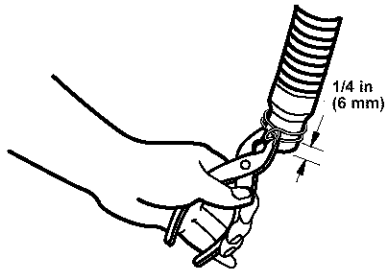

- c. Open clamp. Twist hose back and forth while pushing down onto drain connector at the bottom of the washer. Continue until hose contacts the ribbed stop on the cabinet.
- d. Place clamp over area marked "CLAMP." Release clamp.

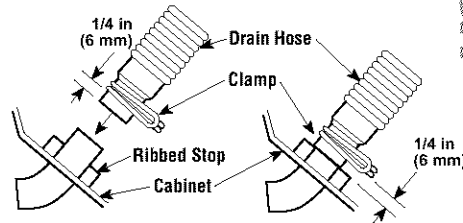
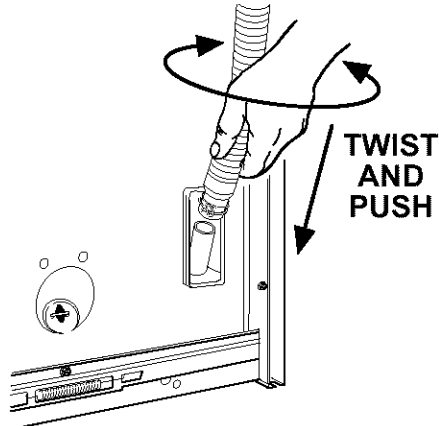

ENGLISH

| If you have: | You will need to buy: |
|---|---|
| Drain hose that is too short | Drain hose, Part No. 388423 and hose kit, Part No. 285442 |
| Drain hose that is too long | Hose kit, Part No. 285442 |
| A problem with lint clogging your drain | Drain protector, Part No. 367031 |

Parts listed are available from your local Sears store or Sears Service Center. In the United States, call 1-800-366-PART (1-800-366-7278). In Canada, call 1-800-469-4663.

For standpipe or laundry tub drain systems:

STEP 2. Open yellow, single-wire clamp with pliers and slide over hooked end of drain hose to secure the rubber and corrugated sections together.

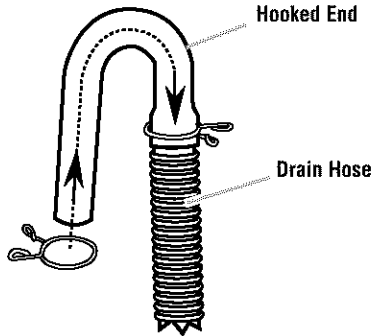

STEP 3. Put hooked end of drain hose into laundry tub or standpipe. Check for proper length of drain hose. Rotate hook to eliminate kinks.

To prevent drain water from going back into the washer:

- Do not straighten hooked end of drain hose and force excess drain hose into standpipe.
- Do not lay excess drain hose in bottom of laundry tub.

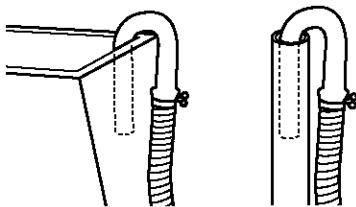

D. CONNECT INLET HOSES TO WASHER

for your **Benefit**

Proper connection of your inlet hoses will allow hot and cold water to enter your washer properly. It also helps prevent water damage due to leaks.

NOTE: Replace inlet hoses after five years of use to reduce the risk of hose failure. Periodically inspect and replace inlet hoses if bulges, kinks, cuts, wear, or leaks are found. When replacing your inlet hoses, mark the date of replacement on the label with a permanent marker.

STEP 1. Insert one new, flat washer (from the parts bag) into each end of the inlet hoses. Check that washers are firmly seated in couplings.

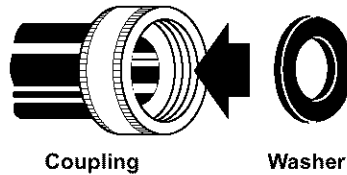

STEP 2. Attach the hose with the red coupling to the hot water (bottom) inlet valve. Attaching the red coupling first makes it easier to tighten connection with pliers. Screw on coupling by hand. Make an additional two-thirds turn with pliers to tighten coupling. **DO NOT OVERTIGHTEN;** this could damage the valves.

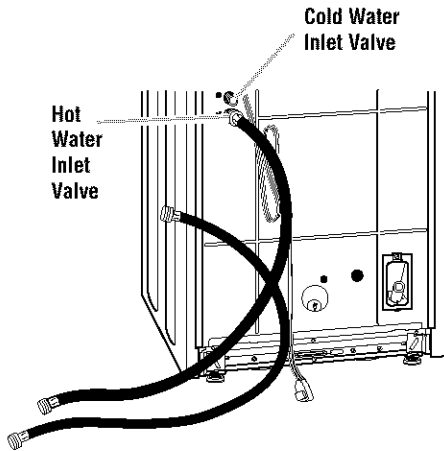

STEP 3. Attach the hose with the blue coupling to the cold water (top) inlet valve. Screw on coupling by hand. Make an additional two-thirds turn with pliers to tighten coupling. **DO NOT OVERTIGHTEN;** this could damage valves.

E. CONNECT INLET HOSES TO WATER FAUCETS

STEP 1. Make sure washer basket is empty. Run water through both faucets into a bucket or laundry tub to get rid of particles in the water lines that might clog hoses. Determine which faucet is hot and which is cold. Mark the hot water faucet.

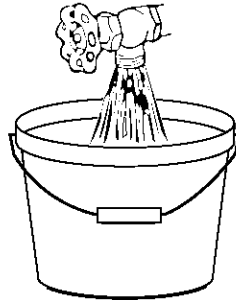

STEP 2. Attach the hose with the red coupling to the hot water faucet. Screw on coupling by hand. Make an additional two-thirds turn with pliers to tighten coupling. **DO NOT OVERTIGHTEN;** this could damage the coupling.

STEP 3. Attach the hose with the blue coupling to the cold water faucet. Screw on coupling by hand. Make an additional two-thirds turn with pliers to tighten coupling. **DO NOT OVERTIGHTEN;** this could damage the coupling.

STEP 4. Turn on water faucets and check for leaks. A small amount of water may enter the washer. You will drain this later.

ENGLISH

| If you have: | You will need to buy: |
|--|--|
| Water faucets beyond the reach of water fill hoses | 2 longer water fill hoses: 6 ft (1.8 m) Part No. 76314 10 ft (3.0 m) Part No. 350008 |

Parts listed are available from your local Sears store or Sears Service Center. In the United States, call 1-800-366-PART (1-800-469-4663). In Canada, call 1-800-469-4663.

F. SECURE DRAIN HOSE

for your **Benefit**

Securing the drain hose properly will protect your floors from damage due to water leakage.

STEP 1. Move washer to its final location.

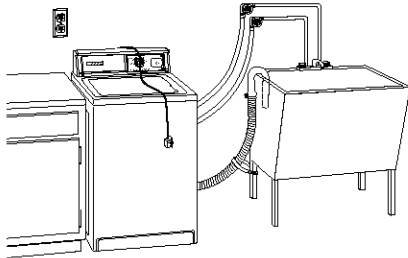

If the water faucets and drain standpipe are recessed, put hooked end of drain hose in standpipe. Tightly wrap the shipping strap around the drain hose and water inlet hoses (not the handles or stems). Push fastener into the nearest hole in the shipping strap.

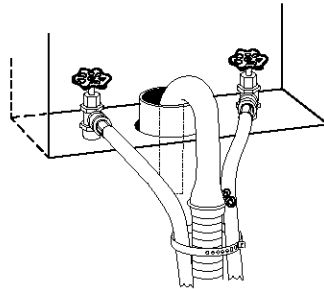

STEP 2. Locate the remaining piece of shipping strap (not the end with the three cotter pins) from STEP 4 of "REMOVE SHIPPING STRAP." Use it to wrap the drain hose together with the laundry tub or standpipe. Push fastener into the nearest hole in the shipping strap.

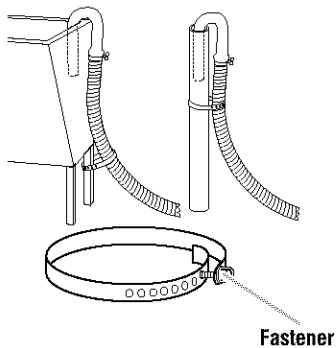

G. LEVEL WASHER

for your **Benefit**

Leveling your washer properly prevents excessive noise and vibration.

To install front legs:

STEP 1. Prop front of washer up (about 4 in [10.2 cm]). Use a wood block or another object that will support the weight of the washer. If washer was placed against a wall, move the washer out slightly before tipping it up.

STEP 2. With one of the legs in hand, screw lock nut onto leg $\frac{3}{8}$ in (9.5 mm) from top of leg base. This is the recommended initial setting.

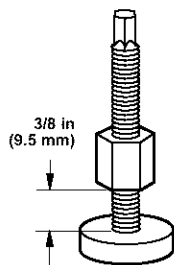

STEP 3. Screw leg into washer base by hand until nut reaches washer base. Repeat for other leg.

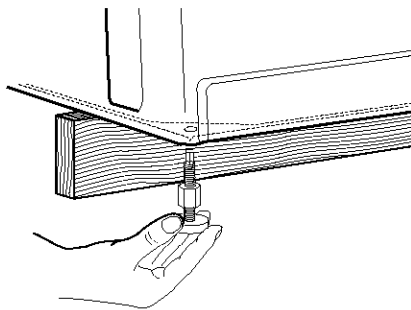

STEP 4. Tilt washer backward until front of washer is off the wood block. Remove wood block. Gently lower washer to floor.

STEP 5. Move washer to its final location.

STEP 6. Tilt washer forward until rear of washer is at least 3 in (7.6 cm) off floor. You may hear the self-adjusting rear legs click into place. Lower washer to floor. Check levelness of the washer by placing a level on top of the washer, first side-to-side; then front-to-back.

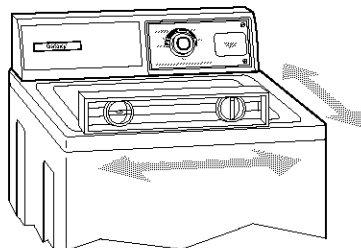

STEP 7. If washer is not level, prop up the front of the washer and adjust the legs up or down as necessary. Lower washer and reset self-adjusting rear legs (as in Step 6). Repeat Step 7 until the washer is level.

STEP 8. When washer is in its final location and level, use a $\frac{3}{16}$ in (1.43 cm) open-end wrench to turn nuts on front legs tightly against washer cabinet. If nuts are not tight against washer cabinet, the washer may vibrate.

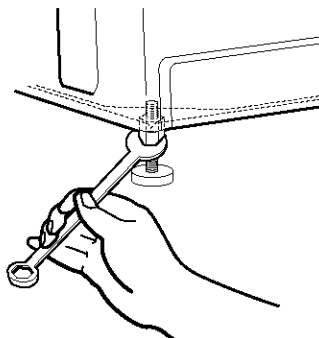

ENGLISH

REVIEW INSTALLATION

***for your* Benefit**

Take a few minutes to complete this checklist. It will help assure you that you have a proper installation and increase your satisfaction with your Sears washer.

- Check electrical requirements.
Be sure you have correct electrical supply and recommended grounding method.
 - Check that you have:
 - All the tools you started with.
 - Removed all packaging materials.
 - Removed shipping strap with cotter pins.
 - Installed all parts listed on pages 7-9.
 - Check that:
 - The washer is level.
 - The nuts on the front legs are tight.
 - Check that the water faucets are turned on.
-

FINAL STEPS

- Plug power supply cord into grounded outlet.
- Remove the blue protective film on the console and any tape remaining on washer.
- Take a few minutes and read the Operating Instructions (pages 21-23) to fully understand your new washer. Then, start the washer and allow it to complete the REGULAR cycle.

OPERATING YOUR WASHER

for your **Benefit**

To get the maximum cleaning and fabric care from your washer, please read and follow these instructions.

⚠ WARNING



Fire Hazard

Never place items in the washer that are dampened with gasoline or other flammable fluids.

No washer can completely remove oil.

Do not dry anything that has ever had any type of oil on it (including cooking oils).

Doing so can result in death, explosion, or fire.

STARTING YOUR WASHER

STEP 1. Add measured detergent directly into washer basket. Then place a load of sorted clothes in the washer.

STEP 2. Close washer lid.

STEP 3. Push the Cycle Selector Control (Timer) knob **A** in and turn to the right. Set time according to the level of soil and type of fabric in the load (see details on page 22).

STEP 4. Pull the Cycle Selector Control (Timer) knob out to start washer.

STOPPING/RESTARTING YOUR WASHER

- To stop the washer at any time, push the Cycle Selector Control (Timer) knob **A** in.
- Pull the knob out to restart.

WASH/RINSE WATER TEMPERATURE

All washes are done in warm water.
All rinses are cold to save energy.

ENGLISH

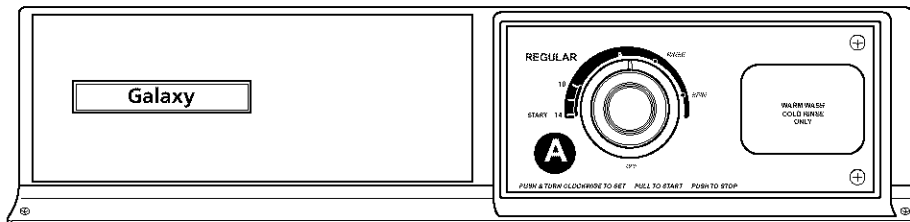

CYCLE SELECTOR (TIMER) CONTROL

Use this control to choose your wash time and to start the washer.

- For heavy soil and sturdy fabrics, use the full time.
- For light soil and delicate fabrics, use less time.

REGULAR

Use this cycle to get up to 14 minutes of wash time for sturdy or heavily soiled loads.

- Wash combines fast speed agitation and fast spin speeds.

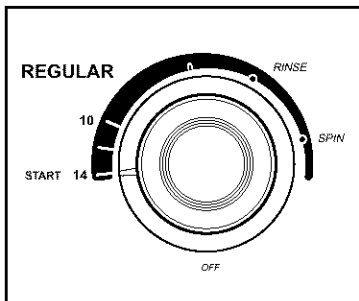

RINSE AND SPIN

When using extra detergent for heavily soiled clothes, or washing special-care items, you may find an extra rinse and spin is needed.

STEP 1. Set the Cycle Selector Control (Timer) knob at RINSE.

STEP 2. Pull Cycle Selector Control (Timer) knob out to start washer.

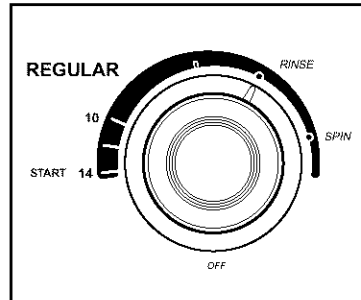

SPIN ONLY

A drain and spin may help shorten drying times for some heavy fabrics or special-care items by removing excess water.

STEP 1. Set the Cycle Selector Control (Timer) knob at SPIN.

STEP 2. Pull the Cycle Selector Control (Timer) knob out to start washer.

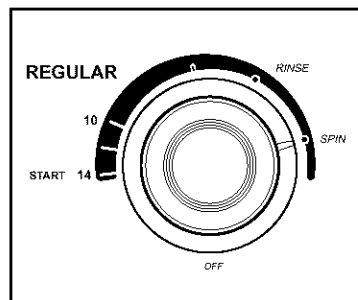

UNDERSTANDING NORMAL WASHER SOUNDS

Your new washer may make sounds that your old one didn't. Because the sounds are unfamiliar, you may be concerned about them.

The following describes some of the normal sounds you may hear and what causes them.









During Drain

The rate that water is drained from your washer depends on your installation. If water is drained quickly from the washer, you may hear air being pulled through the pump. This happens during the end of draining.

After Drain and Before Spin

When the cycle changes from draining to spinning, you may hear a noise as the gearcase shifts.

UNDERSTANDING WHAT HAPPENS DURING THE WASHER CYCLE

| REGULAR | |
|---|-----------------------------|
|  | Fill to selected level ▼ |
|  | Wash selected time ▼ |
|  | Drain – no spin ▼ |
|  | Spin ▼ |
|  | Fill to selected level ▼ |
|  | Rinse ▼ |
|  | Drain – no spin ▼ |
|  | Spin ▼ |
|  | Off |

ENGLISH

CARING FOR YOUR WASHER

CLEANING YOUR WASHER

Proper care of your washer can extend its life. This section explains how to care for your washer properly and safely.

Exterior

Wipe up detergent, bleach, and other spills with a soft, damp cloth or sponge as they occur. Occasionally wipe the outside of the washer to keep it looking like new.

Do not put sharp or metal objects in your washer. They can damage the finish. Check all pockets for pins, clips, money, bolts, nuts, etc. Do not lay these objects on your washer after emptying pockets.

Interior

Clean interior with 1 cup (250 mL) of chlorine bleach mixed with 2 cups (500 mL) of detergent. Run washer through a complete cycle. Repeat process if necessary.

NOTE: Remove hard water deposits using only cleaners labeled as washer safe.

WATER INLET HOSES

Replace inlet hoses after five years of use to reduce the risk of hose failure. Periodically inspect and replace inlet hoses if bulges, kinks, cuts, wear, or leaks are found. When replacing your inlet hoses, mark the date of replacement on the label with a permanent marker.

WINTER STORAGE OR MOVING CARE

Install and store your washer where it will not freeze. Because some water may stay in the hoses and pump, freezing can damage your washer. If storing or moving your washer during freezing weather, winterize it.

To winterize washer:

1. Shut off both water faucets.
2. Disconnect and drain water inlet hoses.
3. Put 1 qt (1 L) of R.V.-type antifreeze in the basket.
4. Run washer on a SPIN setting for about 30 seconds to mix the antifreeze and water. Some of the mixture will pump out while the washer spins.
5. Unplug the power supply cord.

To use washer again:

1. Flush water pipes and hoses.
2. Reconnect water inlet hoses.
3. Turn on both water faucets.
4. Reconnect power supply cord.
5. Run the washer through a complete cycle with 1 cup (250 mL) of detergent to clean out antifreeze.

NON-USE OR VACATION CARE

Operate your washer only when you are at home. If you will be on vacation or not using your washer for an extended period of time, you should:

- Unplug the power supply cord or turn off electrical power to the washer.
- Turn off the water supply to the washer. This helps avoid accidental flooding (due to a water pressure surge) while you are away.

TROUBLESHOOTING

Most laundering problems are easily solved if you understand the cause. Check these lists for common laundry and washer problems. If you need further assistance, see service and assistance information on the back cover.

| Problem | Possible Cause | Solution |
|---|--|--|
| Washer Leaks | Household plumbing is leaking. | Repair plumbing. |
| | Inlet hoses not tight. | Tighten hoses (see "INSTALLATION," Sections D & E). |
| | Inlet hose washers not properly seated. | Reseat washers (see "INSTALLATION," Section D). |
| | Drain hose not properly clamped or is off. | Clamp drain hose (see "INSTALLATION," Section C). |
| | Drain is clogged. | Remove drain clogs. Sink, standpipe, or floor drain must be able to handle 17 gal (64 L) of water per minute. |
| | Tub moved forward during unloading, causing water to deflect off tub ring. | Ensure tub is centered before starting washer. |
| | Unit not level causing water to deflect off tub ring. | Ensure front feet are installed and nuts are tightened. Level washer. Reset rear legs (see "INSTALLATION," Section G). |
| | Load is unbalanced. Spray rinses are deflecting off load. | Redistribute the load. |
| | Washer is overloaded. Fills or spray rinses are deflecting off of load. | Reduce load size. |
| Won't Drain/ Won't Spin/ Wet Loads | Drain hose is kinked or clogged. | Straighten or unplug hose (see "INSTALLATION," Section C). |
| | Correct operation of neutral drain. | After a wash or rinse, the washer will drain without spinning. After draining, the spinning begins. |
| | Lid is open. | Close the lid. |
| | Drain hose is more than 96 in (2.4 m) above floor. | Lower drain hose (see "INSTALLATION," Section C). |
| | Too much detergent – excessive sudsing. | Use less detergent. |
| | Low voltage or using an extension cord. | Check electrical source or call electrician. Do not use extension cords. |

ENGLISH

| Problem | Possible Cause | Solution |
|--|--|--|
| Continues to Fill/ Continues to Drain/ Cycle Stuck | Drain hose is less than 39 in (99 cm) above floor. | Raise the drain hose (see "INSTALLATION," Section C). |
| | Drain hose fits tightly into standpipe. | Adjust drain hose for loose fit (see "INSTALLATION," Section C). |
| | Drain hose taped into standpipe. | Do not seal off drain hose with tape. The drain hose needs an air gap. |
| Washer Makes Noise | Load is unbalanced. | Redistribute load. |
| | Washer is not level. Rear leveling legs not set. | Level washer. Reset rear legs (see "INSTALLATION," Section G). |
| | Nuts on front feet not tight. | Tighten nuts (see "INSTALLATION," Section G). |
| | Yellow shipping strap with cotter pins not completely removed. | Remove strap with cotter pins (see "INSTALLATION," Section B). |
| | Floor not strong enough to support washer. | Relocate washer (see "INSTALLATION," Section A). |
| | Gears engaging after drain and before spin. | This is normal. |
| | Upper part of agitator clicks during wash. | This is normal. |
| Won't Fill/Won't Rinse/Won't Agitate/ Wrong Temperature | Water inlet valve screens are plugged. | Clean screens. |
| | Water is turned off. | Turn on water. |
| | Hot and cold hoses are reversed. | Reverse hoses (see "INSTALLATION," Sections D & E). |
| | Inlet hose is kinked. | Straighten hoses. |
| | Timer dial is not lined up. | Turn timer knob to the right slightly and pull to start. |

| Problem | Possible Cause | Solution |
|---|--|--|
| Machine Stops | Power cord not plugged in. | Plug in power cord. |
| | No power at plug. | Check electrical source or call electrician. |
| | Fuse blown or circuit breaker open. | Replace fuse or reset circuit breaker. If problem continues, call electrician. |
| | Using an extension cord. | Do not use extension cords. |
| | Timer is not lined up. | Turn timer to the right slightly and pull to start. |
| | Timer knob not pulled out. | Set and pull out knob. |
| Agitator Not Working | Machine is overloaded. | Wash smaller loads. |
| | The top of the agitator moves only in one direction. | This is normal. |
| Water Level Too Low/Not Completely Filling | The top of the agitator is loose. | This is normal. |
| | The top of the agitator is much higher than the highest water level. This creates a perception of the washer not being full. | This is normal. |
| Tub is Crooked | Tub pulled forward when unloading. | Ensure tub is centered before starting washer. |
| | Tub moves. | This is normal. |
| | Unit not level. | Ensure front feet are installed and nuts are tightened. Level washer. Reset rear legs (see "INSTALLATION," Section G). |
| Lint on Load | Improper sorting. | Sort lint givers from lint takers and by color. |
| | Overloading. | Lint can be trapped in load if overloaded. Wash smaller loads. |
| | Paper or tissue in pockets. | Clean out pockets before washing. |
| | Not enough detergent. | Use enough detergent to hold lint in water. |
| | Detergent not dissolving. Water temperatures lower than 70°F (21°C). | It is normal for detergents to not dissolve properly in water temperatures lower than 70°F (21°C). |

ENGLISH

| Problem | Possible Cause | Solution |
|---------------------------------|--|---|
| Tearing | Overloading. Improper use of washer. | Loads should move freely during wash. Wash smaller loads or increase water level. |
| | Improper use of chlorine bleach. Undiluted bleach will damage fabrics. | Do not pour chlorine bleach directly on load. Wipe up bleach spills. |
| | Sharp items not removed from pockets; fasteners not fastened. | Clean out pockets before washing. Zip zippers before washing. |
| | Items damaged before washing. | Mend rips and broken threads in seams before washing. |
| Stains on Load | Improper use of fabric softener in washer or dryer. | Dilute fabric softener and add to deep rinse only. |
| | Iron in water (rust). | Install an iron filter. |
| | Under use of detergent causing soil to be redeposited. | Use enough detergent to remove soil and hold it in suspension. |
| | Dye transfer due to not sorting loads properly. | Sort dark clothing from whites and lights. |
| | Dye transfer due to not unloading washer promptly. | Unload the washer as soon as it stops. |
| Load is Wrinkled | Not removing load promptly. | Unload the washer as soon as it stops. |
| | Overloading. | Loads should move freely during wash. Wash smaller loads. |
| | Hoses reversed. | Reverse hoses (see "INSTALLATION," Sections D & E). |
| Load is Tangled/ Twisted | Overloading. | Loads should move freely during wash. Wash smaller loads. |
| | Clothes wrapped around agitator. | Do not wrap items around agitator when loading washer. |

SEARS MAINTENANCE AGREEMENT

GALAXY™ WASHERS

We Service What We Sell

"We Service What We Sell" is our assurance you can depend on Sears for service. Your washer has added value when you consider that Sears has service units nationwide, staffed with professional technicians specifically trained on Sears appliances and having parts, tools and equipment to ensure that we meet our pledge to you...

"We Service What We Sell."

Sears Maintenance Agreement

Maintain the value of your Galaxy™ Washer with a Sears Maintenance Agreement. Galaxy™ washers are designed, manufactured, and tested for years of dependable operation. Yet any appliance may require service from time to time.

The Sears Maintenance Agreement

- Is your way to buy tomorrow's service at today's prices.
- Eliminates repair bills resulting from normal use.
- Allows for as many service calls as required.
- Provides for service by professional Sears-trained Technicians.
- Even if you don't need repairs, the Maintenance Agreement offers an annual preventative maintenance checkup at your request!

For more information, call:

1-800-827-6655 (USA)

1-800-469-4663 (Canada)

ENGLISH

NOTES

**In U.S.A. or Canada
for in-home major brand repair service:**

Call 24 hours a day, 7 days a week

1-800-4-MY-HOMESM (1-800-469-4663)

Para pedir servicio de reparación a domicilio – 1-800-676-5811

Au Canada pour tout le service ou les pièces – 1-800-469-4663

For the repair or replacement parts you need:

Call 6 a.m. – 11 p.m. CST, 7 days a week

PartsDirectSM

1-800-366-PART (1-800-366-7278)

Para ordenar piezas con entrega a domicilio – 1-800-659-7084

For the location of a Sears Service Center in your area:

Call 24 hours a day, 7 days a week

1-800-488-1222

To purchase or Inquire about a Sears Maintenance Agreement:

Call 7 a.m. – 5 p.m. CST, Monday – Saturday

1-800-827-6655

