

Use & Care

G U I D E

Microwave Ovens

A Note to You.....	2
Microwave Oven Safety	3
Installation Instructions.....	5
Getting to Know Your Microwave Oven.....	7
How your microwave oven works.....	7
Radio interference.....	7
For the best cooking results	7
Testing your microwave oven	7
Testing your dinnerware or cookware.....	8
Operating safety precautions.....	8
Electrical connection.....	8
Microwave oven features	9
Control panel features	10
Using PERSONAL CHOICE.....	11
Built-in kits	12
Setting the clock	13
Using the minute timer	13
Using Your Microwave Oven.....	14
Cooking at high cook power.....	14
Cooking at different cook powers	15
Cooking with more than one cook cycle	16
EZ-Choice cooking	17
EZ-Choice cooking chart.....	18
Using AUTO DEFROST.....	20
Defrosting tips	21
Using ADD MINUTE	22
Using WARM HOLD	22
Cooking Guide.....	23
Caring for Your Microwave Oven	24
Questions and Answers	25
Troubleshooting.....	26
Requesting Assistance or Service	27
Warranty	28

1-800-253-1301

Call our Consumer Assistance Center
with questions or comments.



MODELS MT1130SG MT1151SG MT1131SG

3828W5A0588/4359603B

www.whirlpool.com

A NOTE TO YOU

Thank you for buying a WHIRLPOOL® appliance.

The Whirlpool Brand is committed to designing quality products that consistently perform for you to make your life easier. To ensure that you enjoy years of trouble-free operation, we developed this Use and Care Guide. It is full of valuable information about how to operate and maintain your appliance properly and safely. Please read it carefully.

Also, complete and mail the **Product Registration Card** provided with your appliance. The card helps us notify you about any new information on your appliance.

Please record your model's information.

Whenever you call to request service for your appliance, you need to know your complete model number and serial number. You can find this information on the model and serial number label/plate (see the diagram in the "Getting to Know" section).

Please also record the purchase date of your appliance and your dealer's name, address, and telephone number.

Model Number _____

Serial Number _____

Purchase Date _____

Dealer Name _____

Dealer Address _____

Dealer Phone _____

Keep this book and the sales slip together in a safe place for future reference. It is important for you to save your sales receipt showing the date of purchase. Proof of purchase will assure you of in-warranty service.

Our Consumer Assistance Center number is toll free.

1-800-253-1301

To find detailed product information, the location of the nearest Whirlpool dealer or authorized servicer, to purchase an accessory item, or register your appliance on-line, please visit our Web site at www.whirlpool.com

MICROWAVE OVEN SAFETY

Your safety and the safety of others is very important.

We have provided many important safety messages in this manual and on your appliance. Always read and obey all safety messages.



This is the safety alert symbol.

This symbol alerts you to hazards that can kill or hurt you and others.

All safety messages will be preceded by the safety alert symbol and the word "DANGER" or "WARNING." These words mean:

! DANGER

You will be killed or seriously injured if you don't follow instructions.

! WARNING

You can be killed or seriously injured if you don't follow instructions.

All safety messages will identify the hazard, tell you how to reduce the chance of injury, and tell you what can happen if the instructions are not followed.

IMPORTANT SAFETY INSTRUCTIONS

When using electrical appliances basic safety precautions should be followed, including the following:

WARNING – To reduce the risk of burns, electric shock, fire, injury to persons or exposure to excessive microwave energy:

- Read all instructions before using the microwave oven.
- Read and follow the specific "PRECAUTIONS TO AVOID POSSIBLE EXPOSURE TO EXCESSIVE MICROWAVE ENERGY" found in this section.
- The microwave oven must be grounded. Connect only to properly grounded outlet. See "GROUNDING INSTRUCTIONS" found in the "Installation Instructions" section.
- Install or locate the microwave oven only in accordance with the installation instructions.
- Some products such as whole eggs and sealed containers – for example, closed glass jars – may explode and should not be heated in the microwave oven.
- Use the microwave oven only for its intended use as described in this manual. Do not use corrosive chemicals or vapors in the microwave oven. This type of oven is specifically designed to heat, cook, or dry food. It is not designed for industrial or laboratory use.
- As with any appliance, close supervision is necessary when used by children.
- Do not operate the microwave oven if it has a damaged cord or plug, if it is not working properly, or if it has been damaged or dropped.
- The microwave oven should be serviced only by qualified service personnel. Call an authorized service company for examination, repair or adjustment.
- Do not cover or block any openings on the microwave oven.
- Do not store the microwave oven outdoors. Do not use the microwave oven near water – for example, near a kitchen sink, in a wet basement, or near a swimming pool, and the like.
- Do not immerse cord or plug in water.
- Keep cord away from heated surfaces.
- Do not let cord hang over edge of table or counter.
- See door surface cleaning instructions in the "Caring for Your Microwave Oven" section.

– SAVE THESE INSTRUCTIONS –

continued on next page

IMPORTANT SAFETY INSTRUCTIONS

- Do not operate any heating or cooking appliance beneath the microwave oven.
- Do not mount microwave oven over or near any portion of a heating or cooking appliance.
- Do not mount over a sink.
- Do not store anything directly on top of the microwave oven surface when the microwave oven is in operation.
- To reduce the risk of fire in the oven cavity:
 - Do not overcook food. Carefully attend the microwave oven if paper, plastic, or other combustible materials are placed inside the oven to facilitate cooking.
 - Remove wire twist-ties from paper or plastic bags before placing bag in oven.
 - If materials inside the oven should ignite, keep oven door closed, turn oven off, and disconnect the power cord, or shut off power at the fuse or circuit breaker panel.
 - Do not use the cavity for storage purposes. Do not leave paper products, cooking utensils, or food in the cavity when not in use.

– SAVE THESE INSTRUCTIONS –

PRECAUTIONS TO AVOID POSSIBLE EXPOSURE TO EXCESSIVE MICROWAVE ENERGY

- (a)** Do not attempt to operate this oven with the door open since open-door operation can result in harmful exposure to microwave energy. It is important not to defeat or tamper with the safety interlocks.
- (b)** Do not place any object between the oven front face and the door or allow soil or cleaner residue to accumulate on sealing surfaces.
- (c)** Do not operate the oven if it is damaged. It is particularly important that the oven door close properly and that there is no damage to the:
 - (1) door (bent),
 - (2) hinges and latches (broken or loosened),
 - (3) door seals and sealing surfaces.
- (d)** The oven should not be adjusted or repaired by anyone except properly qualified service personnel.

INSTALLATION INSTRUCTIONS

Before you begin operating the oven, carefully read the following instructions.

1. **Empty** the microwave oven and **clean** inside it with a soft, damp cloth. **Check** for damage such as a door that isn't lined up correctly, damage around the door, or dents inside the oven or on the exterior. If there is any damage, do not operate the oven until an authorized service technician has checked it and made any needed repairs.

2. **Put** the oven on a cart, counter, table, or shelf that is strong enough to hold the oven and the food and utensils you put in it. **(The control side of the unit is the heavy side. Use care when handling the oven.)** The weight of the oven is about 40 lbs. The microwave oven should be at a temperature above 50°F for proper operation.

NOTE: (for model MT1130SG only) You can build your microwave oven into a wall or cabinet by using one of the trim kits listed in the "Built-in kits" section.

NOTE: Do not block the exhaust vents or air intake openings. Allow a few inches of space at the back and side of the oven where the exhaust vents are located. Blocking the exhaust vents could cause damage to the oven and poor cooking results. Make sure the microwave oven legs are in place to ensure proper airflow. If vents are blocked, a sensitive thermal safety device automatically turns the oven off. The oven will not work until it has cooled.

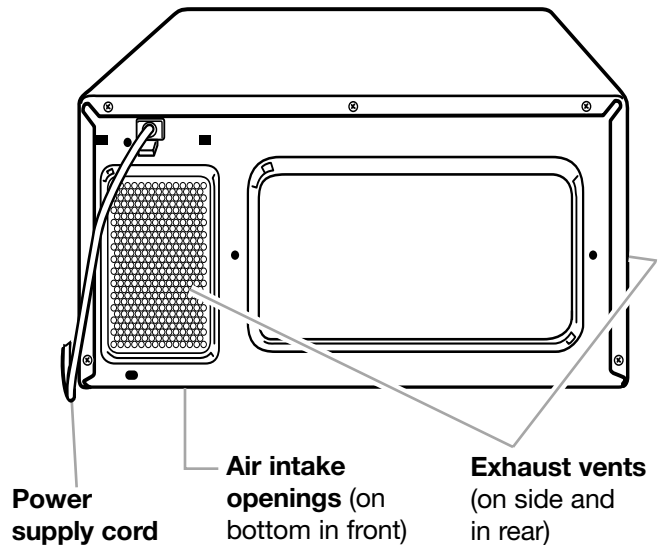

ELECTRICAL REQUIREMENTS

Observe all governing codes and ordinances. A 120 Volt, 60 Hz, AC only, 15 amp fused electrical supply is required. (A time-delay fuse is recommended.) It is recommended that a separate circuit serving only this appliance be provided.

⚠ WARNING

Fire Hazard

Do not install the oven next to or over a heat source without a UL approved trim kit. Doing so can result in death, fire, or electrical shock.

⚠ WARNING

Electrical Shock Hazard

Plug into a grounded 3 prong outlet.
Do not remove ground prong.
Do not use an adapter.
Do not use an extension cord.
Failure to follow these instructions can result in death, fire, or electrical shock.

ELECTRICAL REQUIREMENTS (CONT.)

GROUNDING INSTRUCTIONS

For all cord connected appliances:

The microwave oven must be grounded. In the event of an electrical short circuit, grounding reduces the risk of electric shock by providing an escape wire for the electric current. The microwave oven is equipped with a cord having a grounding wire with a grounding plug. The plug must be plugged into an outlet that is properly installed and grounded.

WARNING – Improper use of the grounding can result in a risk of electric shock.

Consult a qualified electrician or serviceman if the grounding instructions are not completely understood, or if doubt exists as to whether the microwave oven is properly grounded.

Do not use an extension cord. If the power supply cord is too short, have a qualified electrician or serviceman install an outlet near the microwave oven.

For a permanently connected appliance:

The microwave oven must be connected to a grounded, metallic, permanent wiring system, or an equipment grounding conductor should be run with the circuit conductors and connected to the equipment grounding terminal or lead on the microwave oven.

GETTING TO KNOW YOUR MICROWAVE OVEN

This section discusses the concepts behind microwave cooking. It also shows you the basics you need to know to operate your microwave oven. Please read this information before you use your oven.

HOW YOUR MICROWAVE OVEN WORKS

Microwave ovens are safe. Microwave energy is not hot. It causes food to make its own heat, and it's this heat that cooks the food.

Microwaves are like TV waves, radio waves, or light waves. You cannot see them, but you can see what they do.

A **magnetron** in the microwave oven produces microwaves. The microwaves move into the oven where they contact food as it turns on the turntable.

The **glass turntable** of your microwave oven lets microwaves pass through. Then they bounce off a metal floor, back through the glass turntable, and are absorbed by the food.

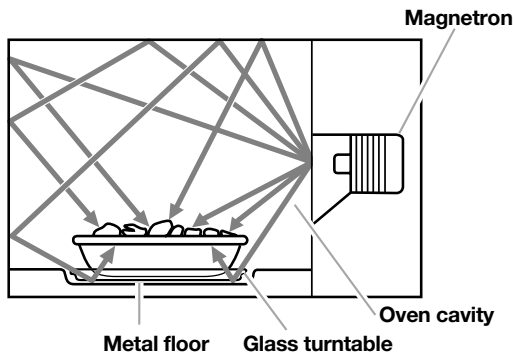

Microwaves pass through most glass, paper, and plastics without heating them so food absorbs the energy. Microwaves bounce off metal containers so food does not absorb the energy.

RADIO INTERFERENCE

Using your microwave oven may cause interference to your radio, TV, or similar equipment. When there is interference, you can reduce it or remove it by:

- **Cleaning** the door and sealing surfaces of the oven.
- **Adjusting** the receiving antenna of the radio or television.
- **Moving** the receiver away from the microwave oven.
- **Plugging** the microwave oven into a different outlet so that the microwave oven and receiver are on different branch circuits.

FOR THE BEST COOKING RESULTS

- **Always cook food** for the shortest cooking time recommended. Check to see how the food is cooking. If needed, touch ADD MINUTE while the oven is operating or after the cooking cycle is over (see the "Using add minute" section).
- **Stir, turn over, or rearrange** the food being cooked about halfway through the cooking time for all recipes. This will help make sure the food is evenly cooked.
- **If you do not have a cover for a dish**, use wax paper, or microwave-approved paper towels or plastic wrap. Remember to turn back a corner of the plastic wrap to vent steam during cooking.

TESTING YOUR MICROWAVE OVEN

To test the oven put about 1 cup of cold water in a glass container in the oven. Close the door. Make sure it latches. Cook at 100% power for 2 minutes. When the time is up, the water should be heated.

TESTING YOUR DINNERWARE OR COOKWARE

Test dinnerware or cookware before using.

To test a dish for safe use, put it into the oven with a cup of water beside it. Cook at 100% cook power for one minute. **If the dish gets hot and water stays cool, do not use it.** Some dishes (melamine, some ceramic dinnerware, etc.) absorb microwave energy, becoming too hot to handle and slowing cooking times. Cooking in metal containers not designed for microwave use could damage the oven, as could containers with hidden metal (twist-ties, foil lining, staples, metallic glaze or trim).

OPERATING SAFETY PRECAUTIONS

- **Never** lean on the door or allow a child to swing on it when the door is open.
- **Use hot pads.** Microwave energy does not heat containers, but the heat from the food can make the container hot.
- **Do not** use newspaper or other printed paper in the oven.
- **Do not** dry flowers, fruit, herbs, wood, paper, gourds, or clothes in the oven.
- **Do not** start a microwave oven when it is empty. Product life may be shortened. If you practice programming the oven, **put** a container of water in the oven. It is normal for the oven door to look wavy after the oven has been running for a while.
- **Do not** try to melt paraffin wax in the oven. Paraffin wax will not melt in a microwave oven because it allows microwaves to pass through it.
- **Do not** operate the microwave oven unless the glass turntable is securely in place and can rotate freely. The turntable can rotate in either direction. **Make sure** the turntable is correct-side up in the oven. **Handle your turntable with care** when removing it from the oven to avoid possibly breaking it. If your turntable cracks or breaks, contact your dealer for a replacement.
- **When you use a browning dish,** the browning dish bottom must be at least $\frac{3}{16}$ inch above the turntable. Follow the directions supplied with the browning dish.
- **Never cook or reheat a whole egg inside the shell.** Steam buildup in whole eggs may cause them to burst, and possibly damage the oven. **Slice** hard-boiled eggs before heating. In rare cases, poached eggs have been known to explode. **Cover** poached eggs and **allow** a standing time of one minute before cutting into them.
- **For best results, stir any liquid several times during heating or reheating.** Liquids heated in certain containers (especially containers shaped like cylinders) may become overheated. The liquid may splash out with a loud noise during or after heating or when adding ingredients (coffee granules, tea bags, etc.). This can harm the oven.
- **Microwaves** may not reach the center of a roast. The heat spreads to the center from the outer, cooked areas just as in regular oven cooking. This is one of the reasons for letting some foods (for example, roasts or baked potatoes) stand for a while after cooking, or for stirring some foods during the cooking time.
- **Do not deep fry in the oven.** Microwavable utensils are not suitable and it is difficult to maintain appropriate deep-frying temperatures.
- **Do not overcook potatoes.** At the end of the recommended cooking time, potatoes should be slightly firm because they will continue cooking during standing time. **After microwaving, let** potatoes stand for 5 minutes. They will finish cooking while standing.

ELECTRICAL CONNECTION

If your electric power line or outlet voltage is less than 110 volts, cooking times may be longer. Have a qualified electrician check your electrical system.

MICROWAVE OVEN FEATURES

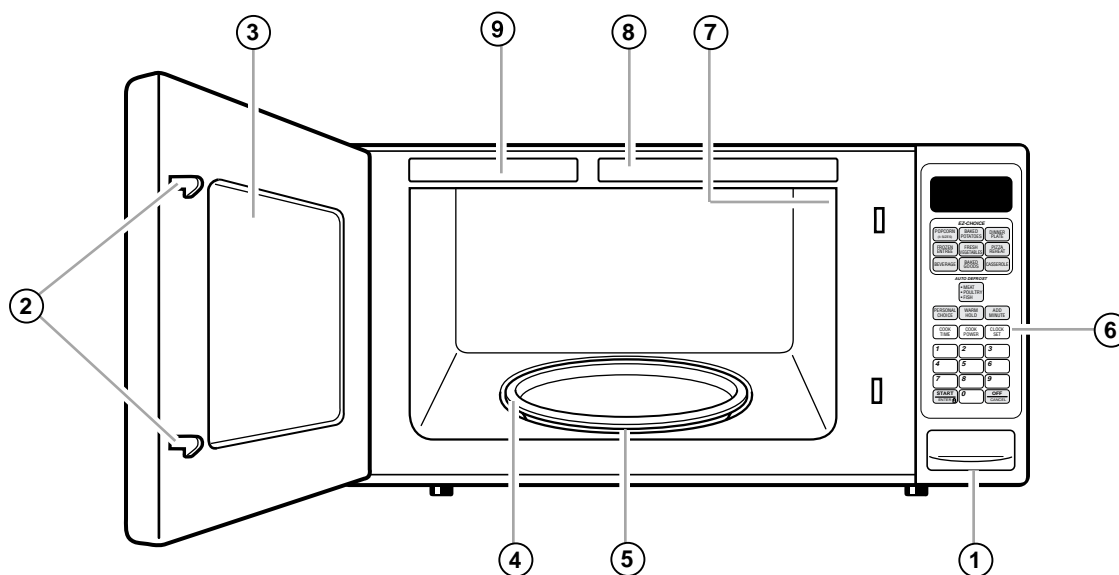

Your microwave oven is designed to make your cooking experience enjoyable and productive. To help get you up and running quickly, the following is a list of the oven's basic features:

- 1. One-Touch Door Open Button.** Push this button to open the door.
- 2. Door Safety Lock System.** The oven will not work unless the door is securely closed.
- 3. Window with Metal Shield.** The shield prevents microwaves from escaping. It is designed as a screen to allow you to view food as it cooks.
- 4. Glass Turntable.** This turntable turns food as it cooks for more even cooking. It must be in the oven during operation for best cooking results. The turntable is sunken into the cavity floor to give you more cooking space and better cooking results.

- 5. Removable Turntable Support** (under turntable).
- 6. Control Panel.** Touch pads on this panel to perform all functions.
- 7. Light** (not shown). Automatically turns on when the door is opened or when the oven is running.
- 8. Cooking Guide Label.**
- 9. Model and Serial Number Plate.**

CONTROL PANEL FEATURES

Your microwave oven control panel lets you select a desired cooking function quickly and easily. The following is a list of all the Command and Number pads located on the control panel.

For more information on these features, see “Using your microwave oven” section.

- 1. Display.** This display includes a clock and indicators to tell you the time of day, cooking time settings, cook powers, quantities, weights, and cooking functions.
- 2. POPCORN.** Touch this pad 1 to 3 times to pop a bag of popcorn in any of three sizes.
- 3. BAKED POTATOES.** Touch this pad 1 to 4 times to bake potatoes.
- 4. DINNER PLATE.** Touch this pad 1 or 2 times to reheat a dinner plate of refrigerated food.
- 5. FROZEN ENTREE.** Touch this pad to heat a frozen entree.
- 6. FRESH VEGETABLES.** Touch this pad 1 to 4 times to cook fresh vegetables.
- 7. PIZZA REHEAT.** Touch this pad 1 to 3 times to reheat slices of pizza.
- 8. BEVERAGE.** Touch this pad 1 to 2 times to **reheat** a beverage.
- 9. BAKED GOODS.** Touch this pad 1 to 4 times to heat baked goods.
- 10. CASSEROLE.** Touch this pad 1 to 4 times to heat a casserole.
- 11. AUTO DEFROST.** Touch this pad to thaw frozen food by weight.
- 12. PERSONAL CHOICE.** Touch this pad and a Number pad to turn off tones, turn off the automatic start of EZ-Choice cooking, or to change weight measurement to kilograms.
- 13. WARM HOLD.** Touch this pad to keep hot, cooked foods safely warm in your microwave oven for up to 60 minutes. You can use WARM HOLD by itself, or to automatically follow a cooking cycle.
- 14. ADD MINUTE.** Touch this pad to cook for one minute at 100% cook power.
- 15. COOK TIME.** Touch this pad followed by Number pads to set a cooking time.
- 16. COOK POWER.** Touch this pad, after the cook time has been set, followed by a Number pad to set the amount of microwave energy released to cook the food. The higher the number, the higher the power wattage and the faster the “cooking speed.”
- 17. CLOCK SET.** Touch this pad to enter the correct time of day.

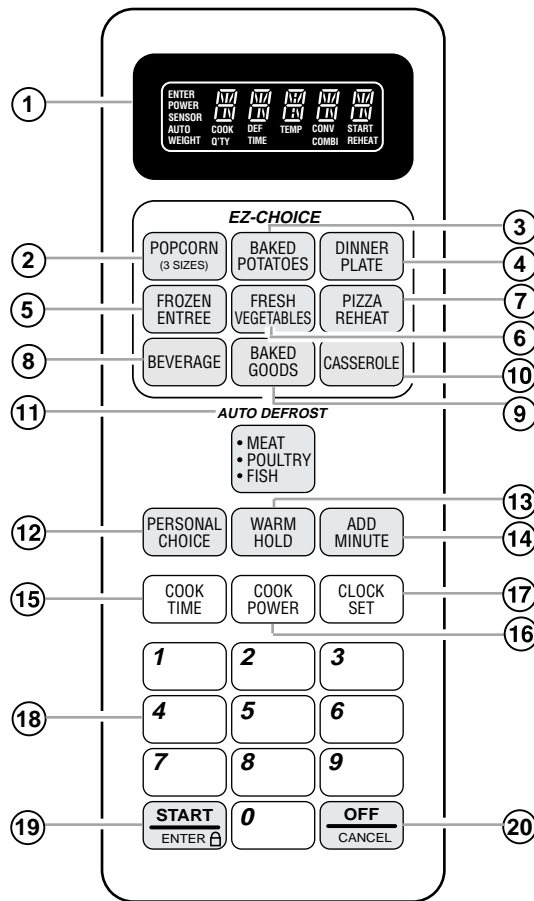

- 18. Number pads.** Touch Number pads to enter cooking times, cook powers, selection, quantities, or weights.
- 19. START/ENTER.** Touch this pad to start a function you have set.
- 20. OFF/CANCEL.** Touch this pad once to erase an incorrect command or twice to cancel a program during cooking. This pad will not erase the time of day.

NOTE: If you try to enter unacceptable instructions, “ERROR” will appear on the display. Touch OFF/CANCEL and re-enter the instructions.

Audible signals

Your microwave oven comes with audible signals that can guide you when setting and using your oven:

- A programming tone will sound each time you touch a pad.
- Three tones signal the end of a cooking cycle or Minute Timer function.

CONTROL PANEL FEATURES (CONT.)

Interrupting cooking

You can stop the oven during a cycle by opening the door. The oven stops heating and the fan stops, but the light stays on. To restart cooking, close the door and

TOUCH



If you do not want to continue cooking:

- Close the door and the light goes off.

OR

- TOUCH



NOTE: Before setting a function, touch OFF/CANCEL to make sure no other function is on.

Using the child lock

The Child Lock locks the control panel so children cannot use the microwave when you do not want them to.

To lock the control panel:

TOUCH



until **LOCK** appears and
2 tones sound (4 seconds)

“L” will appear on the display if a pad is touched.

To unlock the control panel:

TOUCH



until **LOCK** disappears (4 seconds)

Using PERSONAL CHOICE

PERSONAL CHOICE lets you turn off tones, turn off the automatic start of EZ-Choice cooking, or switch weight measurement back and forth between pounds and kilograms.

1. Touch **PERSONAL CHOICE**.

TOUCH

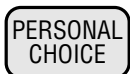

YOU SEE



2. To turn off tones, touch a Number pad.

TOUCH

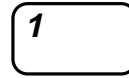

YOU SEE



To turn tones back on, repeat this step.

To turn off automatic start of EZ-Choice cook:

TOUCH

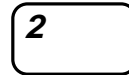

YOU SEE



You will now have to touch START/ENTER to start EZ-Choice cooking. To set up your microwave oven to start without the START/ENTER pad, repeat this step.

To change weight measurement to kilograms:

TOUCH

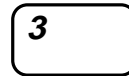

YOU SEE



To change weight measurement back to pounds, repeat this step.

3. Touch **START/ENTER**.

TOUCH



YOU SEE



BUILT-IN KITS (FOR MODEL MTH130SG)

You can build in your microwave oven by using one of the following trim kits*. These kits are available from your dealer. If your dealer does not stock the kit you can order it, by kit part number, by calling **1-800-253-1301** and following the instructions and telephone prompts you hear.

SIZE	COLOR	KIT MODEL NO.	FOR INSTALLATION OVER OVEN MODEL		
24"	Black	MK1134XGB	RBS240PD	RBS245PD	
27"	Black	MK1137XGB	RBS270PD	RBS275PD	RBS277PD
30"	Black	MK1130XGB	RBS305PD	RBS307PD	
24"	White	MK1134XGQ	RBS240PD	RBS245PD	
27"	White	MK1137XGQ	RBS270PD	RBS275PD	RBS277PD
30"	White	MK1130XGQ	RBS305PD	RBS307PB	
27"	Almond	MK1137XGZ	RBS270PD	RBS275PD	RBS277PD
30"	Almond	MK1130XGZ	RBS305PD	RBS307PD	
24"	Stainless steel	MK1134XGS	RBS240PD	RBS245PD	
27"	Stainless steel	MK1137XGS	RBS270PD	RBS275PD	RBS277PD
30"	Stainless steel	MK1130XGS	RBS305PD	RBS307PD	

* Approved, electric single ovens only

SETTING THE CLOCK

When you first plug in your microwave oven, the display shows “0”. If the electric power ever goes off, the display will again show “0” when the power comes back on.

NOTES:

- You can cook without setting the clock, but the display will not show the correct time of day after cooking.
- If you have touched in an incorrect time, such as 12:65, “Err” will flash on the display. Re-enter a correct time.

1. Choose the setting.

TOUCH



2. Enter the time of day.

Example for 3:25:

TOUCH

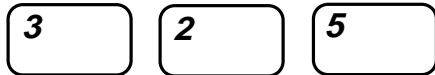

3. Complete your entry.

TOUCH



USING THE MINUTE TIMER

You can use your microwave oven as a kitchen timer. Use the minute timer for timing up to 99 minutes, 99 seconds.

NOTE: If you want to use other Command pads while the minute timer is counting down, touch OFF/CANCEL to cancel the minute timer.

1. Touch COOK TIME.

TOUCH



2. Enter the time to be counted down.

Example for 3 minutes:

TOUCH

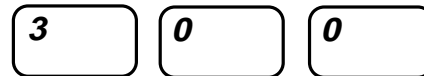

3. Set a “0” cook power.

TOUCH



4. Start the countdown.

TOUCH



(display counts down set time)

5. At the end of the set time:

(3 tones sound)

TOUCH



The display will show the time of day when you touch OFF/CANCEL.

USING YOUR MICROWAVE OVEN

This section gives you instructions for operating each function. Please read these instructions carefully.

COOKING AT HIGH COOK POWER

1. Put the food in the oven and close the door.

2. Set the cooking time.

TOUCH



YOU SEE



Example for 1 minute, 30 seconds:

TOUCH

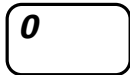
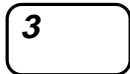
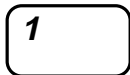

YOU SEE



3. Start the oven.

TOUCH



YOU SEE



4. At the end of the cooking time:
(3 tones sound)

YOU SEE

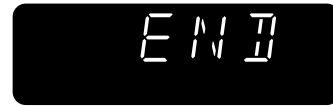

TOUCH



The display will show the time of day when you touch OFF/CANCEL.

COOKING AT DIFFERENT COOK POWERS

For best results, some recipes call for different cook powers. The lower the cook power, the slower the cooking. Each Number pad also stands for a different percentage of cook power. Many microwave cook-book recipes tell you by number, percent, or name which cook power to use.

The following chart gives the percentage of cook power each Number pad stands for, and the cook power name usually used. It also tells you when to use each cook power. Follow recipe or food package instructions if available.

NOTE: Refer to a reliable cookbook for cooking times.

COOK POWER	NAME	WHEN TO USE IT
100% of full power (automatic)	High	<ul style="list-style-type: none"> ● Quick heating many convenience foods and foods with high water content, such as soups and beverages ● Cooking small tender pieces of meat, ground meat, poultry pieces, fish fillets, and most vegetables
9=90% of full power	Medium-High	● Heating cream soups
8=80% of full power		● Heating rice, pasta, or stirrable casseroles
7=70% of full power		<ul style="list-style-type: none"> ● Cooking and heating foods that need a cook power lower than high (for example, whole fish and meat loaf) or when food is cooking too fast ● Reheating a single serving of food
6=60% of full power	Medium	<ul style="list-style-type: none"> ● Cooking sensitive foods such as cheese and egg dishes, pudding, and custards ● Cooking non-stirrable casseroles, such as lasagna
5=50% of full power		<ul style="list-style-type: none"> ● Cooking ham, whole poultry, and pot roasts ● Melting chocolate
4=40% of full power		<ul style="list-style-type: none"> ● Simmering stews ● Heating pastries
3=30% of full power	Medium-Low, Defrost	<ul style="list-style-type: none"> ● Defrosting foods, such as bread, fish, meats, poultry, and precooked foods
2=20% of full power	Low	● Softening butter, cheese, and ice cream
1=10% of full power		<ul style="list-style-type: none"> ● Keeping food warm ● Taking chill out of fruit

NOTE: Once cook time has been entered you can also use the COOK POWER pad as a second Minute Timer by entering “0” for the cook power. The oven will count down the cooking time you set without cooking.

continued on next page

COOKING AT DIFFERENT COOK POWERS (CONT.)

1. Put your food in the oven and close the door.

2. Set the cooking time.

TOUCH



Example for 7 minutes, 30 seconds:

TOUCH

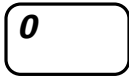
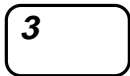
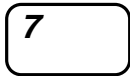

3. Set the cook power.

TOUCH



Example for 50% cook power:

TOUCH

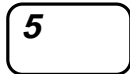

4. Start the oven.

TOUCH



(Cooking time counts down.)

5. At the end of the cooking time:

TOUCH



(3 tones sound)

The display will show the time of day when you touch OFF/CANCEL.

COOKING WITH MORE THAN ONE COOK CYCLE

For best results, some recipes call for one cook power for a certain length of time, and another cook power for another length of time. Your oven can be set to change from one to another automatically, for up to 3 cycles.

You can set your chosen cook functions in any order. However, when you use AUTO DEFROST, it must be the first cycle.

1. Put your food in the oven and close the door.

2. Set the cooking time for the first cycle.

TOUCH



Example for 7 minutes, 30 seconds:

TOUCH

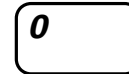
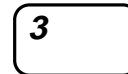
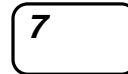

3. Set the cook power for the first cycle.

TOUCH



Example for 50% cook power:

TOUCH

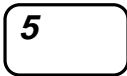

4. Repeat Steps 2 and 3 to set the cooking time and cook power for each additional cycle.

5. Start the oven.

TOUCH



YOU SEE

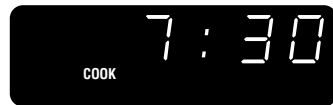

After the first cycle is over, 2 tones sound and the next cycle(s) will count down.

COOKING WITH MORE THAN ONE COOK CYCLE (CONT.)

6. At the end of the cooking time:

(3 tones sound)

TOUCH



The display will show the time of day when you touch OFF/CANCEL.

EZ-CHOICE COOKING

You can cook common microwave-prepared foods just by choosing a category and quantity. EZ-Choice has preset times and cook powers for nine categories.

To EZ-Choice cook, follow the steps below:

1. Touch the pad for the food you want.

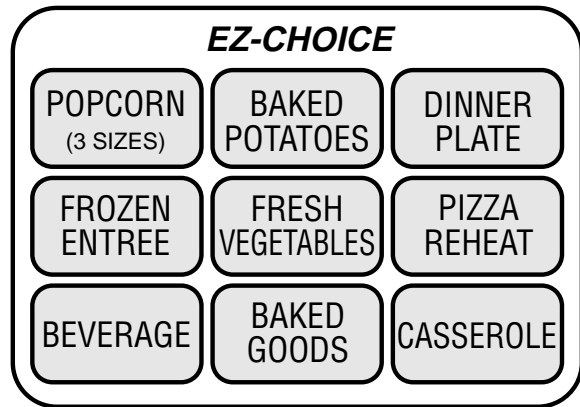

2. Touch the pad again if you want a different serving size. (See “EZ-Choice cooking chart” on the next page for serving sizes available.)
3. The oven starts heating in a few seconds (unless the automatic start has been turned off).

continued on next page

EZ-CHOICE COOKING CHART

PAD	TOUCH PAD	SERVING SIZE	DIRECTIONS
Popcorn	once twice 3 times	3.5 oz 3.0 oz 1.75 oz	<ul style="list-style-type: none"> ● Follow package directions. ● Use a popcorn package which is made especially for microwave cooking. ● Do not try to pop unpopped kernels. ● Pop only 1 package at a time. ● Do not leave the microwave oven unattended while popping popcorn. ● If you are using a microwave popcorn popper, follow manufacturer's instructions. ● How well your popcorn cooks will depend on the brand of popcorn and how much fat it has in it. Try several brands to decide which pops the best. For best results, use fresh bags of popcorn.
Baked potatoes	once twice 3 times 4 times	1 (10 to 13 oz) 2 (16 to 20 oz) 3 (24 to 30 oz) 4 (32 to 40 oz)	<ul style="list-style-type: none"> ● Pierce potato several times with fork. ● Place in center of the oven on paper towel. ● After cooking, let stand for 5 minutes. ● No cover.
Dinner plate (refrigerated)	once twice	1 serving 2 servings	<ul style="list-style-type: none"> ● Arrange food on microwave plate. Place meaty portions and bulky vegetables to outside of plate. ● Cover with plastic wrap. ● Vent corner. ● After cooking, let stand for 2 minutes.
Frozen entree	once	10 oz	<ul style="list-style-type: none"> ● Follow package directions. ● Some examples of frozen entrees are Lasagna with meat sauce, Chicken with Rice, and Sliced Turkey Breast with Rice and Vegetable.
Fresh vegetables	once twice 3 times 4 times	1 cup 2 cups 3 cups 4 cups	<ul style="list-style-type: none"> ● Prepare vegetable (wash, cut up vegetable into 1/2-inch slices or pieces). Cover with plastic wrap. <ul style="list-style-type: none"> 1 cup – Add 2 tablespoons water 2 cups – Add 2 tablespoons water 3 cups – Add 1/4 cup water 4 cups – Add 1/4 cup water ● Most vegetables need 2 minutes or 3 minutes standing time after cooking.

EZ-CHOICE COOKING CHART (CONT.)

PAD	TOUCH PAD	SERVING SIZE	DIRECTIONS
Pizza reheat (refrigerated)	once	1 slice (5 oz)	<ul style="list-style-type: none"> ● Place the refrigerated pizza on the plate in the center of the microwave oven.
	twice	2 slices (10 oz)	
	3 times	3 slices (15 oz)	
Beverage	once	1 cup	<ul style="list-style-type: none"> ● Use a mug or microwave-safe cup. ● Stir after reheating.
	twice	2 cups	
Baked goods	once	1 (2 oz)	<ul style="list-style-type: none"> ● Place in the center of the oven on a paper towel. ● If baked good size is more than 3 oz (85 g), enter serving size as "2".
	twice	2 (4 oz)	
	3 times	3 (6 oz)	
	4 times	4 (8 oz)	
Casserole (refrigerated)	once	1 cup	<ul style="list-style-type: none"> ● Cover dish containing the casserole with plastic wrap. ● At the end of cooking, stir if possible.
	twice	2 cups	
	3 times	3 cups	
	4 times	4 cups	

NOTE: If you touch an EZ-Choice pad more than the times shown in this chart, the display returns to the first serving size.

USING AUTO DEFROST

You can defrost food by choosing a category and setting a weight. AUTO DEFROST has preset times and cook powers for 3 categories: Meat, Poultry, and Fish.

To use **AUTO DEFROST**, follow the steps below:

1. TOUCH



1 to 3 times to choose the type of food.

2. Touch Number pad(s) to enter the weight.

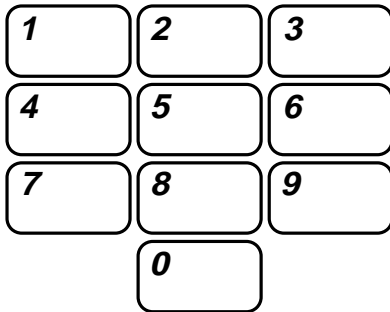

3. TOUCH



This chart shows you how to choose a type of food and the weights you can set for each type. For best results, loosen or remove covering on food.

FOOD	TOUCH DEFROST	WEIGHTS YOU CAN SET (tenths of a pound)
Meat	once	.1 to 6.0
Poultry	twice	.1 to 6.0
Fish	3 times	.1 to 6.0

NOTES:

- If you enter a weight higher than the highest weight allowed for your food setting, one long tone will sound and “ERROR” will appear on the display when you touch START/ENTER.
- If you touch the AUTO DEFROST pad 4 times, the display returns to the Meat setting.
- See the “Auto defrost chart” later in this section for defrosting directions for each food.
- To defrost items not listed in the “Auto defrost chart,” use 30% cook power. Refer to a reliable cookbook for defrosting information.
- Twice during defrosting, 5 tones will sound. These tones tell you when to check, turn over, separate, or rearrange the food. See the “Auto defrost chart” later in this section for instructions on what to do when the tones sound. To start the oven again, touch START/ENTER.

USING AUTO DEFROST (CONT.)

Weight conversion chart

You are probably used to food weights as being in pounds and ounces that are fractions of a pound (for example, 4 ounces equals $\frac{1}{4}$ pound). However, in order to enter food weight in AUTO DEFROST, you must specify pounds and tenths of a pound.

If the weight on the food package is in fractions of a pound, you can use the following chart to convert the weight to decimals.

Equivalent Weight		
OUNCES		DECIMAL WEIGHT
1.6		.10
3.2		.20
4.0		.25 One-Quarter Pound
4.8		.30
6.4		.40
8.0		.50 One-Half Pound
9.6		.60
11.2		.70
12.0		.75 Three-Quarters Pound
12.8		.80
14.4		.90
16.0		1.00 One Pound

DEFROSTING TIPS

- **When using** AUTO DEFROST, the weight to be entered is the net weight in pounds and tenths of pounds (the weight of the food minus the container).
- **Before starting**, make sure you have removed any of the metal twist-ties which often come with frozen food bags, and replace them with strings or elastic bands.
- **Open containers** such as cartons before they are placed in the oven.
- **Always slit** or pierce plastic pouches or packaging.
- **If food is foil wrapped**, remove foil and place it in a suitable container.
- **Slit** the skins, if any, of frozen food such as sausage.
- **Bend** plastic pouches of food to ensure even defrosting.
- **Always underestimate** defrosting time. If defrosted food is still icy in the center, return it to the microwave oven for more defrosting.
- **The length** of defrosting time varies according to how solidly the food is frozen.
- **The shape of the package** affects how quickly food will defrost. Shallow packages will defrost more quickly than a deep block.
- **As food begins to defrost**, separate the pieces. Separated pieces defrost more easily.
- **Use small pieces of aluminum foil** to shield parts of food such as chicken wings, leg tips, fish tails, or areas that start to get warm. Make sure the foil does not touch the sides, top, or bottom of the oven. The foil can damage the oven lining.
- **For better results**, let food stand after defrosting. (For more information on standing time, see “Microwave cooking tips” in the “Cooking Guide” section.)
- **Turn over** food during defrosting or standing time. Break apart and remove food as required.

Using ADD MINUTE

ADD MINUTE lets you cook food for 1 minute at 100% cook power.

NOTES:

- Each time you touch ADD MINUTE, it will add 1 minute.
- You can enter ADD MINUTE only after closing the door or after touching OFF/CANCEL.
- You can only use ADD MINUTE to start the oven if no other cooking function is running.

1. Make sure your food is in the oven.

2. Touch add minute.

Example when cooking for 1 minute:

TOUCH



once

3. At the end of the cooking time:

(3 tones sound)

TOUCH



The display will show the time of day when you touch OFF/CANCEL.

Using WARM HOLD

You can safely keep hot, cooked food warm in your microwave oven for up to 60 minutes. You can use WARM HOLD by itself, or to automatically follow a cooking cycle.

NOTES:

- WARM HOLD operates for up to 60 minutes.
- Opening the oven door cancels WARM HOLD. Close the door and touch WARM HOLD, then touch START/ENTER if additional WARM HOLD time is desired.
- Food cooked covered should be covered during WARM HOLD.
- Pastry items (pies, turnovers, etc.) should be uncovered during WARM HOLD.
- Complete meals kept warm on a dinner plate should be covered during WARM HOLD.
- Do not use more than 1 complete WARM HOLD cycle (about 60 minutes). The quality of some foods will suffer with extended time.

1. Put hot, cooked food in the oven and close the door.

2. Touch warm hold.

TOUCH



3. Start the oven.

TOUCH



To make WARM HOLD automatically follow another cycle:

- While you are entering cooking instructions, touch WARM HOLD before touching START/ENTER.
- When the last cooking cycle is over, you will hear 2 tones. "Hold" will come on while the oven continues to run.

COOKING GUIDE

MICROWAVE COOKING TIPS

Amount of food

- **If you increase or decrease** the amount of food you prepare, the time it takes to cook that food will also change. For example, if you double a recipe, add a little more than half the original cooking time. Check for doneness and, if necessary, add more time in small increments.

Starting temperature of food

- **The lower the temperature** of the food being put into the microwave oven, the longer it takes to cook. Food at room temperature will be reheated more quickly than food at refrigerator temperature.

Composition of food

- **Food with a lot of fat and sugar** will be heated faster than food containing a lot of water. Fat and sugar will also reach a higher temperature than water in the cooking process.
- **The more dense the food**, the longer it takes to heat. “Very dense” food like meat takes longer to reheat than lighter, more porous food like sponge cakes.

Size and shape

- **Smaller pieces of food** will cook faster than larger pieces. Also, same-shaped pieces cook more evenly than different-shaped pieces.
- **With foods that have different thicknesses**, the thinner parts will cook faster than the thicker parts. **Place** the thinner parts of chicken wings and legs in the center of the dish.

Stirring, turning foods

- **Stirring and turning foods** spreads heat quickly to the center of the dish and avoids overcooking at the outer edges of the food.

Covering food

Cover food to:

- **Reduce** splattering
- **Shorten** cooking times
- **Keep** food moist

You can use any covering that lets microwaves pass through.

Releasing pressure in foods

- **Several foods** (for example: baked potatoes, sausages, egg yolks, and some fruits) are tightly covered by a skin or membrane. Steam can build up under the membrane during cooking, causing the food to burst. To relieve the pressure and to

prevent bursting, **pierce** these foods before cooking with a fork, cocktail pick, or toothpick.

Using standing time

- **Always allow food to stand** after cooking. Standing time after defrosting and cooking allows the temperature to evenly spread throughout the food, improving the cooking results.
- **The length of the standing time** depends on how much food you are cooking and how dense it is. Sometimes it can be as short as the time it takes you to remove the food from the oven and take it to the serving table. However, with larger, denser food, the standing time may be as long as 10 minutes.

Arranging food

For best results, place food evenly on the plate. You can do this in several ways:

- **If you are cooking several items of the same food**, such as baked potatoes, **place** them in a ring pattern for uniform cooking.
- **When cooking foods of uneven shapes or thickness, such as chicken breasts**, **place** the smaller or thinner area of the food towards the center of the dish where it will be heated last.
- **Layer thin slices of meat** on top of each other.
- **When you cook or reheat whole fish**, **score** the skin – this prevents cracking.
- **Do not** let food or a container touch the top or sides of the oven. This will prevent possible arcing.

Using aluminum foil

Metal containers should not be used in a microwave oven. There are, however, some exceptions. If you have purchased food which is prepackaged in an aluminum foil container, refer to the instructions on the package. When using aluminum foil containers, cooking times may be longer because microwaves will only penetrate the top of the food.

If you use aluminum containers without package instructions, follow these guidelines:

- **Place** the container in a glass bowl and add some water so that it covers the bottom of the container, not more than $\frac{1}{4}$ inch high. This ensures even heating of the container bottom.
- **Always remove** the lid to avoid damage to the oven.
- **Use only** undamaged containers.
- **Do not use** containers taller than $\frac{3}{4}$ inch.
- **Container must be** at least half filled.
- **To avoid arcing**, there must be a minimum $\frac{1}{4}$ inch between the aluminum container and the walls of the oven and also between two aluminum containers.

continued on next page

MICROWAVE COOKING TIPS (CONT.)

- **Always place** the container on the turntable.
- **Reheating food** in aluminum foil containers usually takes up to double the time compared to reheating in plastic, glass, china, or paper containers. The time when food is ready will vary depending upon the type of container you use.
- **Let food stand** for 2 to 3 minutes after heating so that heat is spread evenly throughout container.

Cooking you should not do in your microwave oven

- **Do not** do canning of foods in the oven. Closed glass jars may explode, resulting in damage to the oven.
- **Do not** use the microwave oven to sterilize objects (baby bottles, etc.). It is difficult to keep the oven at the high temperature needed for safe sterilization.

CARING FOR YOUR MICROWAVE OVEN

To make sure your microwave oven looks good and works well for a long time, you should maintain it properly. For proper care, please follow these instructions carefully.

For interior surfaces: Wash often with warm, sudsy water and a sponge or soft cloth. **Use** only mild, non-abrasive soaps or a mild detergent. **Be sure to keep the areas clean where the door and oven frame touch when closed.** Wipe well with clean water. Over time, stains can occur on the surfaces as the result of food particles spattering during cooking. This is normal.

For stubborn soil, **boil** a cup of water in the oven for 2 or 3 minutes. Steam will soften the soil. To get rid of odors inside the oven, **boil** a cup of water with lemon juice or vinegar.

For exterior surfaces and control panel: Use a soft cloth with spray glass cleaner. Apply the spray glass cleaner to the soft cloth; do not spray directly on the oven.

NOTE: Abrasive cleansers, steel-wool pads, gritty wash cloths, some paper towels, etc., can damage the control panel and the interior and exterior oven surfaces.

To clean turntable and turntable support, wash in mild, sudsy water; for heavily soiled areas **use** a mild cleanser and scouring sponge. The turntable and turntable support are dishwasher-safe.

QUESTIONS AND ANSWERS

QUESTIONS	ANSWERS
Can I operate my microwave oven without the turntable or turn the turntable over to hold a large dish?	No. If you remove or turn over the turntable, you will get poor cooking results. Dishes used in your oven must fit on the turntable.
Can I use a rack in my microwave oven so that I may reheat or cook on two levels at a time?	You can use a rack only if the rack is supplied with your microwave oven. If you use a rack not supplied with the microwave oven, you can get poor cooking performance and/or arcing.
Can I use either metal or aluminum pans in my microwave oven?	You can use aluminum foil for shielding (use small, flat pieces), small skewers, and shallow foil trays (if tray is not taller than 1.9 cm [$\frac{3}{4}$ inch] deep and half filled with food to absorb microwave energy). Never allow metal to touch walls or door.
Is it normal for the turntable to turn in either direction?	Yes. The turntable rotates clockwise or counter-clockwise, depending on the rotation of the motor when the cooking cycle begins.
Sometimes the door of my microwave oven appears wavy. Is this normal?	This appearance is normal and does not affect the operation of your oven.
What are the humming noises that I hear when my microwave oven is operating?	You may hear the sound of the transformer when the magnetron tube cycles on.
Why does the dish become hot when I microwave food in it? I thought that this should not happen.	As the food becomes hot it will conduct the heat to the dish. Be prepared to use hot pads to remove food after cooking.
What does “standing time” mean?	“Standing time” means that food should be removed from the oven and covered for additional time to allow it to finish cooking. This frees the oven for other cooking.
Why does steam come out of the air exhaust vent?	Steam is normally produced during cooking. The microwave oven has been designed to vent this steam out the vents.
Can I pop popcorn in my microwave oven? How do I get the best results?	Yes. Pop packaged microwave popcorn following manufacturer’s guidelines or use the pre-set POPCORN pad. Do not use regular paper bags. Use the “listening test” by stopping the oven as soon as the popping slows to a “pop” every 1 or 2 seconds. Do not repop unpopped kernels. Do not pop popcorn in glass cookware.

TROUBLESHOOTING

Most cooking problems often are caused by little things you can find and fix without tools of any kind. Check the lists below before calling for assistance or service. If you still need help, see the “Requesting Assistance or Service” section.

IF MICROWAVE DOES NOT OPERATE, FIRST CHECK THE FOLLOWING:

- Is the microwave plugged into a live outlet with the proper voltage? (See installation instructions.)
- Have you blown a household fuse or tripped a circuit breaker?
- Has the electric company experienced a power failure?

OTHER POSSIBLE PROBLEMS AND THEIR CAUSES:

Problem	Cause
The microwave oven will not run.	<ul style="list-style-type: none">● The door is not firmly closed and latched.● You did not touch START/ENTER.● You did not follow directions exactly.● An operation that was programmed earlier is still running.● You have not entered numbers after touching COOK TIME.
Microwave cooking times seem too long.	<ul style="list-style-type: none">● The electric supply to your home or wall outlets is low or lower than normal. Your electric company can tell you if the line voltage is low. Your electrician or service technician can tell you if the outlet voltage is low.● The cook power is not at the recommended setting.● Larger amounts of food need longer cooking times.
The turntable will not turn.	<ul style="list-style-type: none">● The turntable is not correctly in place. Make sure the turntable is correct-side up and is sitting securely on center shaft.● The support is not operating correctly. Remove turntable, check that the turntable support is properly in place, and restart oven. If turntable support does not move, call an authorized service technician for repair. Cooking without the turntable can give you poor results.
The display shows a time counting down but the oven is not cooking.	<ul style="list-style-type: none">● The oven door is not closed completely.● You have set the controls as a kitchen timer. Touch OFF/CANCEL to cancel the Minute Timer.
You do not hear the Programming Tone.	<ul style="list-style-type: none">● The command is not correct.
The fan seems to be running slower than usual.	<ul style="list-style-type: none">● The oven has been stored in a cold area. The fan will run slower until the oven warms up to normal room temperature.
The display is showing “:”.	<ul style="list-style-type: none">● There has been a power interruption. Reset the clock.

If none of these items is causing your problem, see the “Requesting Assistance or Service” section on page 27.

REQUESTING ASSISTANCE OR SERVICE

To avoid unnecessary service calls, please check the “Troubleshooting” section. It may save you the cost of a service call. If you still need help, follow the instructions below.

IF YOU NEED ASSISTANCE OR SERVICE

Call the Whirlpool Consumer Assistance Center toll free at 1-800-253-1301. Our consultants are available to assist you.



When calling:

Please know the purchase date, and the complete model and serial number of your appliance (see the “A Note to You” section). This information will help us better respond to your request.

Our consultants provide assistance with:

- Features and specifications on our full line of appliances
- Installation information

- Use and maintenance procedures
- Accessory and repair parts sales
- Specialized customer assistance (Spanish speaking, hearing impaired, limited vision, etc.)
- Referrals to local dealers, service companies, and repair parts distributors

Whirlpool service technicians are trained to fulfill the product warranty and provide after-warranty service, anywhere in the United States.

To locate the authorized Whirlpool service company in your area, you can also look in your telephone directory Yellow Pages.

FOR FURTHER ASSISTANCE

If you need further assistance, you can write to Whirlpool with any questions or concerns at:

Whirlpool Brand Home Appliances
Consumer Assistance Center
c/o Correspondence Dept.
2000 North M-63
Benton Harbor, MI 49022-2692

Please include a daytime phone number in your correspondence.

WARRANTY

WHIRLPOOL® MICROWAVE OVEN

LENGTH OF WARRANTY	WHIRLPOOL WILL PAY FOR
FULL ONE-YEAR WARRANTY FROM DATE OF PURCHASE	FSP® replacement parts and repair labor to correct defects in materials or workmanship. Service must be provided by an authorized Whirlpool service company.
LIMITED FOUR-YEAR WARRANTY SECOND THROUGH FIFTH YEAR FROM DATE OF PURCHASE	FSP replacement magnetron tube on microwave ovens if defective in materials or workmanship.
WHIRLPOOL WILL NOT PAY FOR	
<p>A. Service calls to:</p> <ol style="list-style-type: none"> 1. Correct the installation of your microwave oven. 2. Instruct you how to use your microwave oven. 3. Replace house fuses or correct house wiring. 4. Replace owner-accessible light bulbs. <p>B. Repairs when your microwave oven is used in other than normal, single-family household use.</p> <p>C. In-home service. Your microwave oven must be taken to an authorized Whirlpool service company, except when your microwave oven is installed over an approved Whirlpool oven using an approved built-in kit. (See the "Built-In kits" section for a list of approved built-in kits.)</p> <p>D. Damage to your microwave oven caused by accident, misuse, fire, flood, acts of God, or use of products not approved by Whirlpool.</p> <p>E. Any labor costs during limited warranty.</p> <p>F. Repairs to parts or systems resulting from unauthorized modifications made to the appliance.</p>	

9/97

WHIRLPOOL CORPORATION SHALL NOT BE LIABLE FOR INCIDENTAL OR CONSEQUENTIAL DAMAGES. Some states do not allow the exclusion or limitation of incidental or consequential damages, so this exclusion or limitation may not apply to you. This warranty gives you specific legal rights, and you may also have other rights which vary from state to state.

Outside the United States, a different warranty may apply. For details, please contact your authorized Whirlpool dealer.

If you need service, first see the "Troubleshooting" section of this book. After checking "Troubleshooting," additional help can be found by checking the "Requesting Assistance or Service" section or by calling our Consumer Assistance Center telephone number, **1-800-253-1301**, from anywhere in the U.S.A.