

# Owner's Manual and Installation Instructions

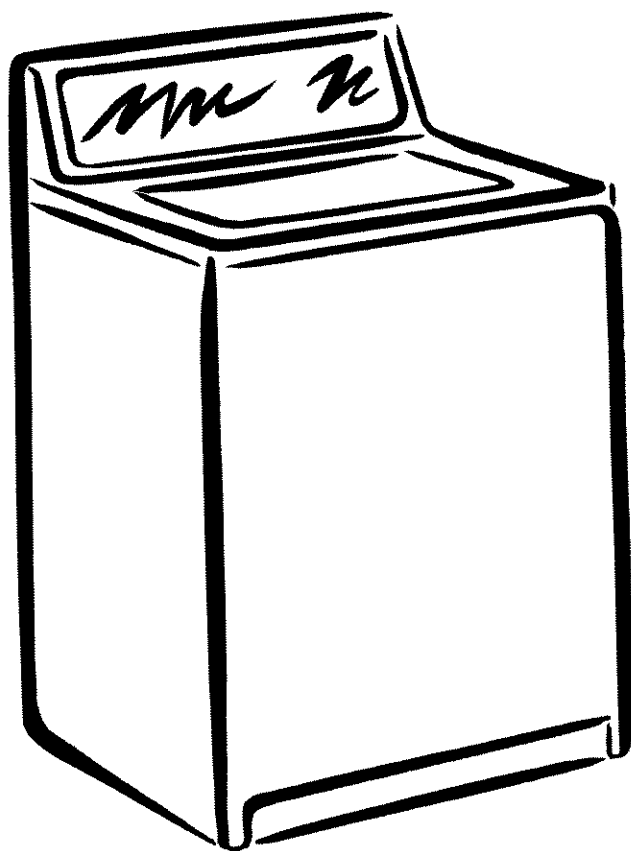

## One-Speed AUTOMATIC WASHERS



ENGLISH

**IMPORTANT:**

Read and follow all safety  
and operating instructions  
before first use of this product.

Sears, Roebuck and Co., Hoffman Estates, IL 60179 U.S.A.  
Sears Canada Inc., Toronto, Ontario, Canada M5B 2B8

[www.sears.com](http://www.sears.com)  
[www.sears.ca](http://www.sears.ca)

3955142

PRINTED IN U.S.A.

10/00

## TABLE OF CONTENTS

BEFORE USING YOUR NEW WASHER .....	2
KENMORE AUTOMATIC WASHER WARRANTY .....	3
WASHER SAFETY .....	4
INSTALLATION INSTRUCTIONS .....	6
OPERATING YOUR WASHER .....	21
LAUNDRY TIPS .....	27
CARING FOR YOUR WASHER .....	29
TROUBLESHOOTING .....	30
SEARS MAINTENANCE AGREEMENT .....	36

## BEFORE USING YOUR NEW WASHER

Please read this manual. It will help you install and operate your new Kenmore washer in the most economical way.

For more information about the care and operation of Kenmore appliances, call your nearest Sears store. You will need the complete model and serial numbers when requesting information. Your washer's model and serial numbers are located on the Model and Serial Number Plate.

Use the space below to record the model number and serial number of your new Kenmore washer.

Model No. \_\_\_\_\_

Serial No. \_\_\_\_\_

Date of Purchase \_\_\_\_\_

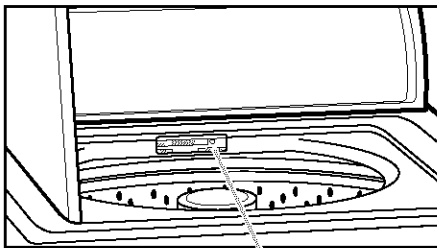

Model and Serial  
Number Plate

**Keep this book and your Sears Salescheck (receipt) in a safe place for future reference.**

## KENMORE AUTOMATIC WASHER WARRANTY

### Limited Lifetime Warranty on White Porcelain Basket

For the lifetime of the washer from the date of purchase, Sears will replace the white porcelain wash basket if it chips or rusts due to defective material or workmanship. After the first year, you will be charged for labor.

### Limited 10-Year Warranty on Plastic Tub\*

For the second through tenth year from the date of purchase, Sears will replace the plastic tub if it is defective in material or workmanship. After the first year, you will be charged for labor.

### Limited 5-Year Warranty on Gearcase Parts\*

For the second through fifth year from the date of purchase, Sears will replace any gearcase parts that are defective in material or workmanship. After the first year, you will be charged for labor.

### Full 1-Year Warranty on "Spreckle" Porcelain Basket

For one year from the date of purchase, when this washer is installed and operated according to the instructions that come with it, Sears will replace the "spreckle" (speckled surface) porcelain wash basket if it chips or rusts due to defective material or workmanship.

### Full 1-Year Warranty on Mechanical and Electrical parts

For one year from the date of purchase, if this washer is installed and operated according to the instructions that come with it, Sears will repair or replace any of its mechanical or electrical parts if they are defective in material or workmanship.

### Warranty Restriction

If this washer is operated for any purpose other than private family use, all warranty coverage is restricted to 90 days from the date of purchase.

### Warranty Service

Warranty service is available by contacting your nearest Sears Service Center in the United States or Canada.

This warranty applies only while this washer is used in the United States or Canada.

This warranty gives you specific legal rights and you may also have other rights that vary from state to state or province to province.

**Sears, Roebuck and Co.,  
Dept 817WA,  
Hoffman Estates, IL 60179**

**Sears Canada Inc.,  
Toronto, Ontario, Canada  
M5B 2B8**

\*In Canada, a different warranty may apply.

In the U.S. for Sears warranty information or to contact a Sears Service Center, call 1-800-4-MY-HOME<sup>SM</sup> (1-800-469-4663). In Canada, call 1-877-533-6937.

ENGLISH

## WASHER SAFETY

### **Your safety and the safety of others are very important.**

We have provided many important safety messages in this manual and on your appliance. Always read and obey all safety messages.



This is the safety alert symbol. This symbol alerts you to potential hazards that can kill or hurt you and others. All safety messages will follow the safety alert symbol and either the word "DANGER" or "WARNING." These words mean:

**⚠ DANGER**

**You can be killed or seriously injured if you don't immediately follow instructions.**

**⚠ WARNING**

**You can be killed or seriously injured if you don't follow instructions.**

All safety messages will tell you what the potential hazard is, tell you how to reduce the chance of injury, and tell you what can happen if the instructions are not followed.

## IMPORTANT SAFETY INSTRUCTIONS

**WARNING:** To reduce the risk of fire, electric shock, or injury to persons when using your washer, follow basic precautions, including the following:

- Read all instructions before using the washer.
- Do not wash articles that have been previously cleaned in, washed in, soaked in, or spotted with gasoline, dry-cleaning solvents, other flammable or explosive substances as they give off vapors that could ignite or explode.
- Do not add gasoline, dry-cleaning solvents, or other flammable or explosive substances to the wash water. These substances give off vapors that could ignite or explode.
- Under certain conditions, hydrogen gas may be produced in a hot water system that has not been used for 2 weeks or more. **HYDROGEN GAS IS EXPLOSIVE.** If the hot water system has not been used for such a period, before using a washing machine, turn on all hot water faucets and let the water flow from each for several minutes. This will release any accumulated hydrogen gas. As the gas is flammable, do not smoke or use an open flame during this time.
- Do not allow children to play on or in the washer. Close supervision of children is necessary when the washer is used near children.
- Before the washer is removed from service or discarded, remove the door or lid.
- Do not reach into the washer if the drum, tub or agitator is moving.
- Do not install or store this washer where it will be exposed to the weather.
- Do not tamper with controls.
- Do not repair or replace any part of the washer or attempt any servicing unless specifically recommended in the Owner's Manual or in published user-repair instructions that you understand and have the skills to carry out.
- See the "INSTALLATION INSTRUCTIONS" section for grounding requirements.

**SAVE THESE INSTRUCTIONS**

ENGLISH

# INSTALLATION INSTRUCTIONS

## INSTALLATION OVERVIEW

For a complete list of tools and parts needed, see pages 7-9.

### A. SELECT LOCATION FOR YOUR WASHER (pgs. 11-13)

Recessed Area/  
Closet Installation Instructions (p. 11)

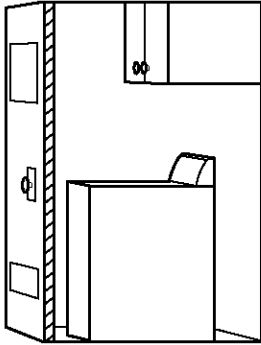

Laundry Tub Drain System (p. 12)

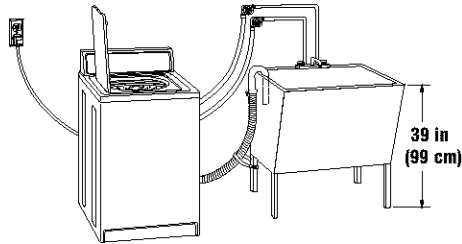

Standpipe Drain System (p. 13)

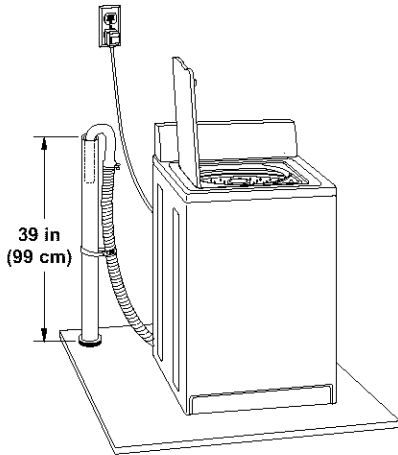

Floor Drain System (p. 13)

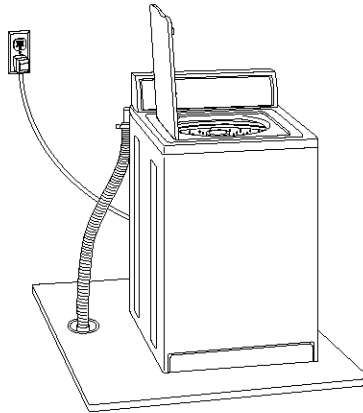

**B. REMOVE SHIPPING STRAP (p. 14)**

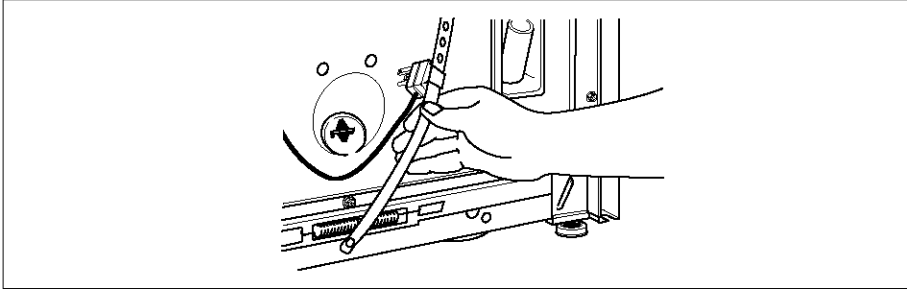

**Tools Needed:**

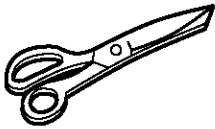

Scissors

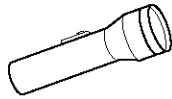

Flashlight (optional depending on installation)

ENGLISH

**C. CONNECT DRAIN HOSE (pgs. 15-16)**

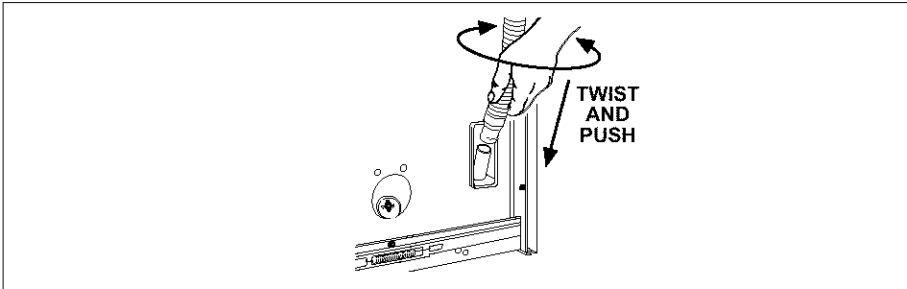

**Tools Needed:**

**Parts Supplied:**

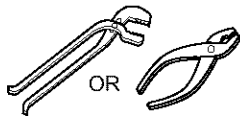

Pliers that open to  $1\frac{5}{16}$  in (3.95 cm)

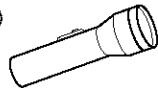

Flashlight (optional depending on installation)

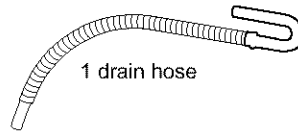

1 drain hose



1 yellow, single-wire hose clamp (top of drain hose)



1 silver, double-wire hose clamp (bottom of drain hose)

**D. CONNECT INLET HOSES TO WASHER (pgs. 16-17)**

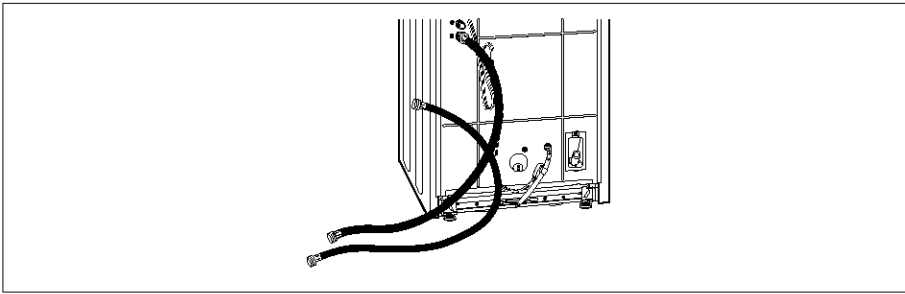

**Tools Needed:**

**Parts Supplied:**

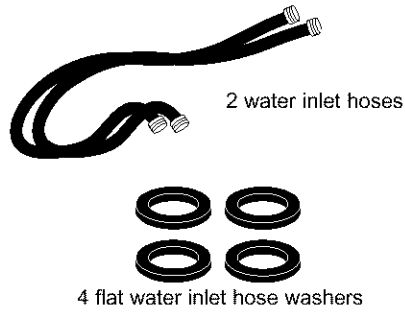
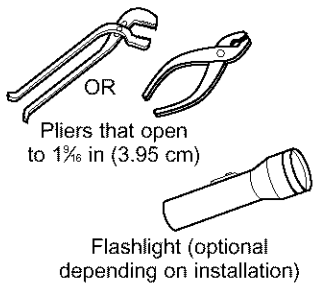

**E. CONNECT INLET HOSES TO WATER FAUCETS (p. 17)**

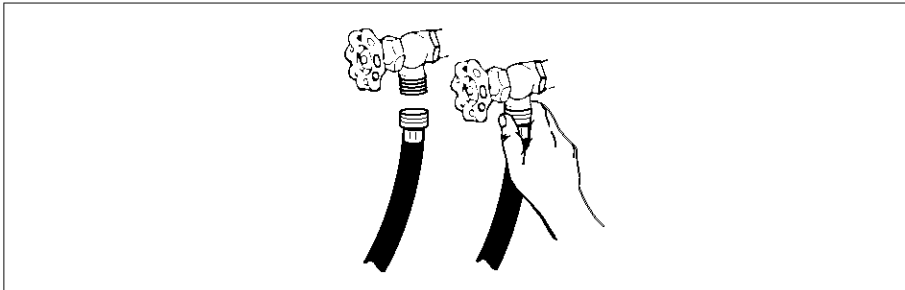

**Tools Needed:**

**Parts Supplied:**

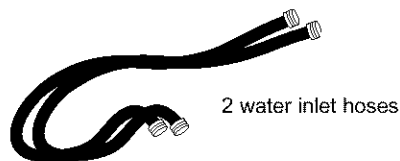
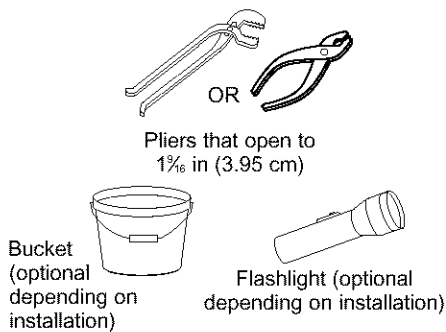



**F. SECURE DRAIN HOSE (p. 18)**

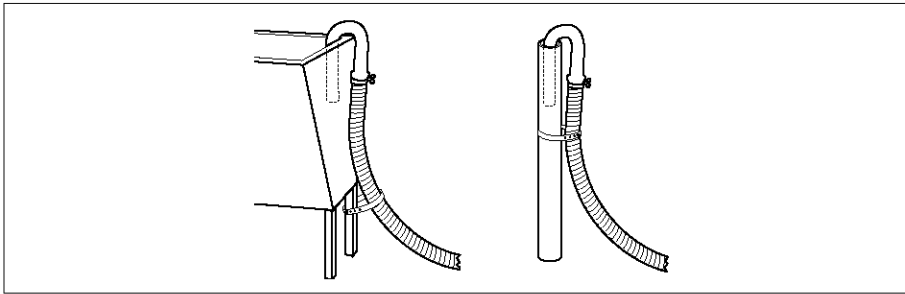

**Tools Needed:**

**Parts Supplied:**

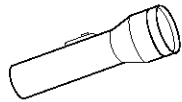

Flashlight (optional  
depending on installation)

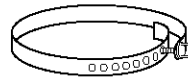

Shipping strap with fastener

ENGLISH

**G. LEVEL WASHER (p. 19)**

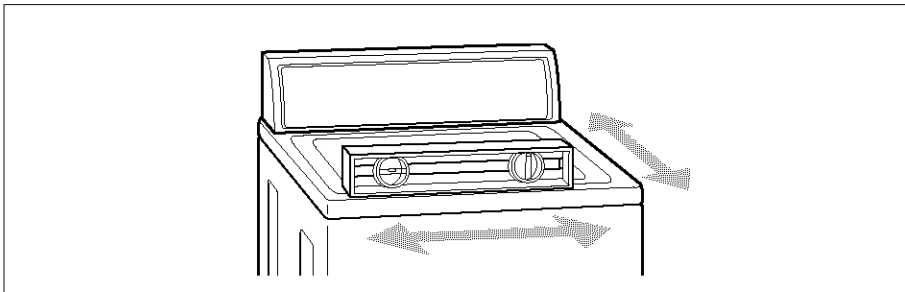

**Tools Needed:**

**Parts Supplied:**

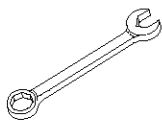

1/8-in (1.43 cm)  
open-end wrench

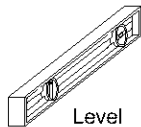

Level

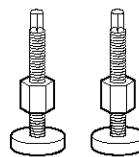

2 front leveling legs with nuts

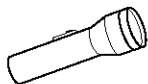

Flashlight (optional  
depending on installation)

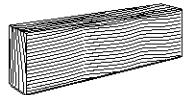

Wood block

## ELECTRICAL REQUIREMENTS

120-Volt, 60-Hz., AC-only, 15- or 20-ampere fused electrical supply is required. (Time-delay fuse or circuit breaker is recommended.) Connect to an individual branch circuit.

**⚠ WARNING**



**Electrical Shock Hazard**

**Plug into a grounded 3 prong outlet.**  
**Do not remove ground prong.**  
**Do not use an adapter.**  
**Do not use an extension cord.**  
**Failure to follow these instructions can result in death, fire, or electrical shock.**

This washer is equipped with a power supply cord having a 3-prong grounding plug. To minimize possible shock hazard, you must plug the power supply cord into a mating 3-prong grounding-type wall receptacle, grounded in accordance with National Electrical Code, ANSI/NFPA 70-latest edition and all local codes and ordinances.

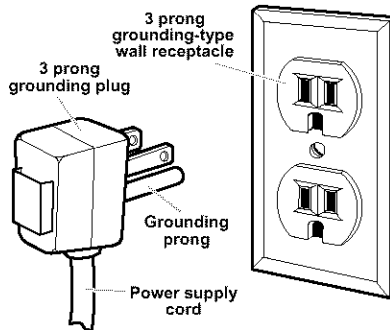

### • For a grounded, cord-connected washer:

#### GROUNDING INSTRUCTIONS

This washer must be grounded. In the event of malfunction or breakdown, grounding will reduce the risk of electrical shock by providing a path of least resistance for electric current. This washer is equipped with a cord having an equipment-grounding conductor and a grounding plug. The plug must be plugged into an appropriate outlet that is properly installed and grounded in accordance with all local codes and ordinances.

**WARNING:** Improper connection of the equipment grounding conductor can result in a risk of electric shock. Check with a qualified electrician or serviceman if you are in doubt as to whether the appliance is properly grounded.

Do not modify the plug provided with the appliance – if it will not fit the outlet, have a proper outlet installed by a qualified electrician.

### • For a permanently connected washer:

#### GROUNDING INSTRUCTIONS

This washer must be connected to a grounded metal, permanent wiring system, or an equipment grounding conductor must be run with the circuit conductors and connected to the equipment-grounding terminal or lead on the appliance.

**A. SELECT LOCATION  
FOR YOUR WASHER**

**for your Benefit**

Selecting the proper location for your washer will improve its performance and minimize concerns like washer walk or noise.

**RECESSED AREA/  
CLOSET INSTALLATION INSTRUCTIONS**

This washer may be installed in a recessed area or closet.

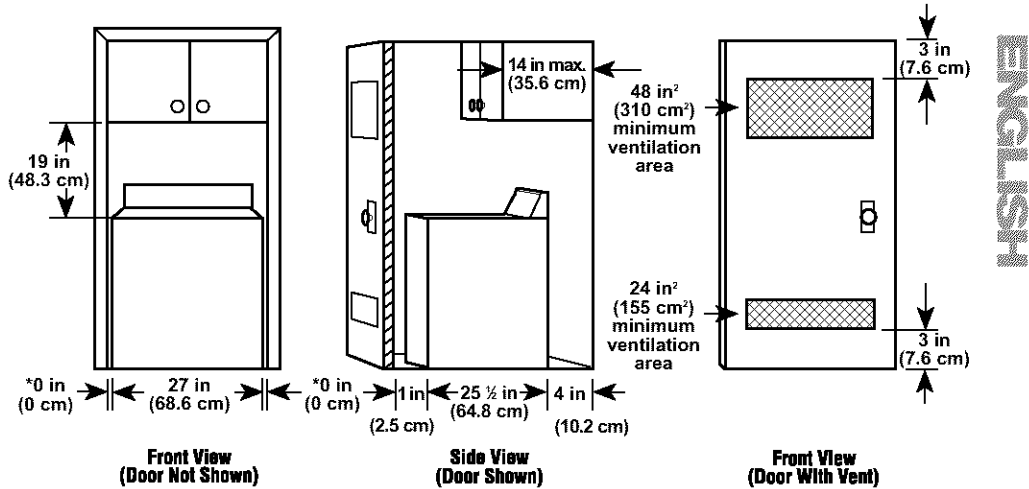

ENGLISH

\* Additional clearance for wall, door and floor moldings may be required.  
To reduce the transfer of washer sounds, a clearance of 1 in (2.5 cm) on the sides of the washer is suggested.

- The installation spacing is in inches (centimeters) and is the minimum allowable.
- Allow additional space if other appliances are to be installed in the area.
- If closet door is installed, the minimum air openings in top and bottom are required. Louvered doors with equivalent air openings in top and bottom are acceptable.

## LAUNDRY TUB DRAIN SYSTEM

Check location where washer will be installed. This washer can be installed using one of three systems:

- Laundry tub drain system (below)
- Standpipe drain system (p. 13)
- Floor drain system (p. 13)

Do not store or operate washer at or below 32°F (0°C) (some water may remain in washer). See page 29 for winterizing information.

Proper installation is your responsibility. Make sure you have everything necessary for correct installation, including the following points:

**Grounded receptacle:** Must be within 4 ft (1.2 m) of where the power cord is attached to the back of the washer.

**Hot and cold water faucets:** Must provide water pressure between 5-100 psi and be within 4 ft (1.2 m) of the hot and cold water fill valves attached to the back of the washer.

**Laundry tub drain system:** Needs a minimum 20 gal (76 L) laundry tub.

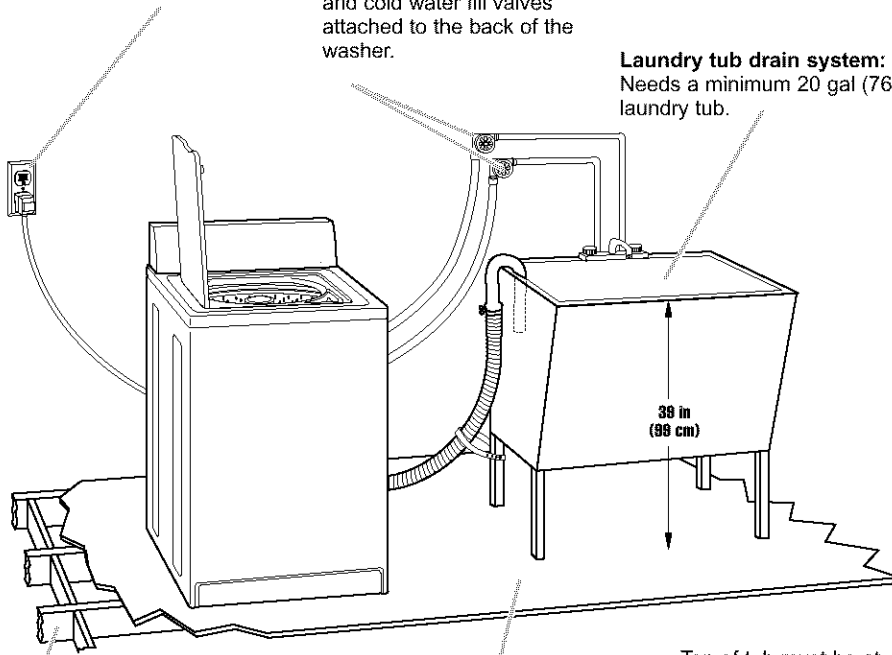

**Support:** Floor must be sturdy enough to support a total weight of 315 lbs (143 kg) (including washer, water, and load weight).

**Level floor:** Maximum allowable slope under entire washer – 1 in (2.5 cm).

Top of tub must be at least 39 in (99 cm) above floor and no higher than 96 in (2.4 m) from bottom of washer.

**ALTERNATE LOCATIONS –  
STANDPIPE AND FLOOR DRAIN SYSTEMS**

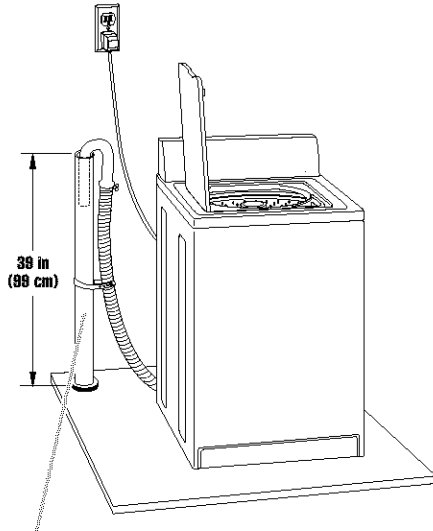

**Standpipe drain system:** Needs a 2 in (5 cm) minimum diameter standpipe with minimum carry-away capacity of 17 gal (64 L) per minute. Top of standpipe must be at least 39 in (99 cm) above floor and no higher than 96 in (2.4 m) from bottom of washer.

**Siphon break:** Must be purchased separately. See chart below.

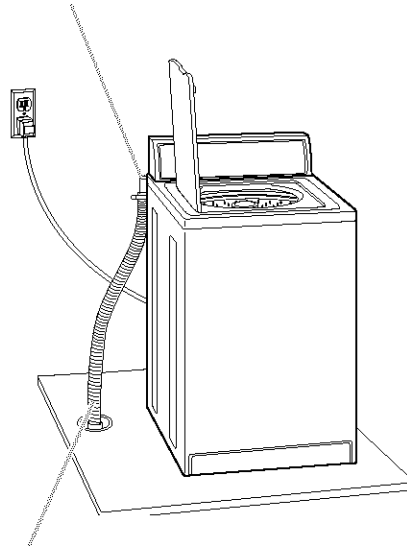

**Floor drain system:** Requires a siphon break, see chart below. A minimum carry-away capacity of 17 gal (64 L) per minute is required.

ENGLISH

<b>If you have:</b>	<b>You will need to buy:</b>
Laundry tub or standpipe taller than 96 in (2.4 m)	Sump pump system (if not already available)
1 in (2.5 cm) diameter standpipe	2 in (5 cm) diameter to 1 in (2.5 cm) diameter standpipe adapter, Part No. 3363920
Overhead sewer	Standard 20 gal (99 cm), 39 in (99 cm) tall drain tub or utility sink and sump pump (available from local plumbing suppliers)
Floor drain	Siphon break, Part No. 285320; additional drain hose, Part No. 3357090; and Connector Kit, Part No. 285442

Parts listed are available from your local Sears store or Sears Service Center. In the United States, call 1-800-366-PART (1-800-366-7278). In Canada, call 1-877-533-6937.

## B. REMOVE SHIPPING STRAP

### **for your Benefit**

Removing the shipping strap is necessary for smooth operation. If the shipping strap is not removed, the washer will make excessive noise.

### **⚠ WARNING**

#### **Excessive Weight Hazard**

Use two or more people to move and install washer.

Failure to do so can result in back or other injury.

To prevent floor damage, set washer onto cardboard before moving across floor. Move washer close to its final location.

**STEP 1.** Do not cut yellow strap. Pull yellow strap firmly, until completely removed from washer. Depending on your model, there should be either two or three cotter pins on the end of the shipping strap when it is pulled out of the washer. The electrical plug is attached to this shipping strap.

Electrical plug

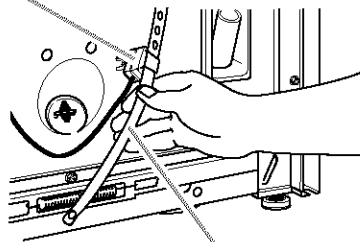

Shipping strap

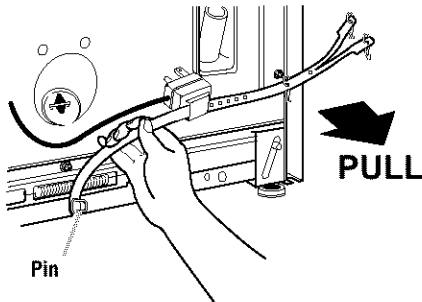

**STEP 2.** Pull firmly to remove the end of the shipping strap that remains pinned to the back of the washer. This will release the rear self-leveling legs.

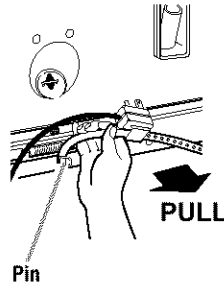

**STEP 3.** Cut the shipping strap about 16 in (40 cm) from plug end. Look for the words "CUT HERE." Discard end with the cotter pins. **Slide remainder of shipping strap from the electrical plug.** You will use this to secure the drain hose.

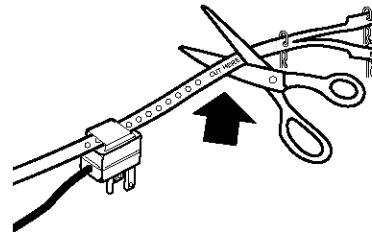
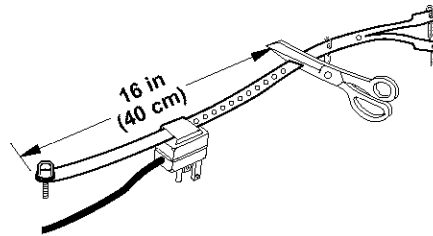

## C. CONNECT DRAIN HOSE

### **for your Benefit**

Proper connection of the drain hose will protect your floors from damage due to water leakage.

**STEP 1.** To prevent the drain hose from coming off or leaking, it must be installed per the following instructions:

**IMPORTANT:** To ensure proper installation, this procedure must be followed exactly.

- a. Wet the inside of the straight end of the drain hose with tap water. **DO NOT USE ANY OTHER LUBRICANT.**
- b. Squeeze ears of silver, double-wire clamp with pliers to open. Place clamp over the straight end of the drain hose  $\frac{1}{4}$  in (6 mm) from the end.

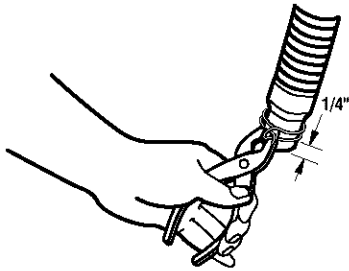

- c. Open clamp. Twist hose back and forth while pushing down onto drain connector at the bottom of the washer. Continue until hose contacts the ribbed stop on the cabinet.

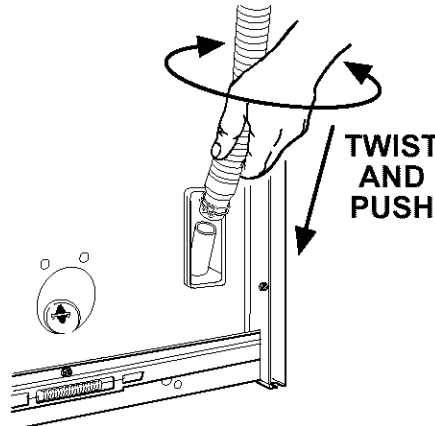

- d. Place clamp over area marked "CLAMP." Release clamp.

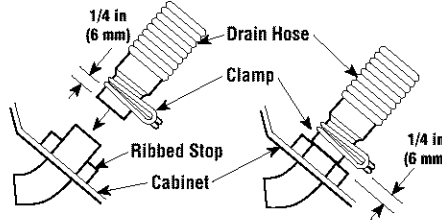

ENGLISH

If you have:	You will need to buy:
Drain hose that is too short	Drain hose, Part No. 388423 and hose kit, Part No. 285442
Drain hose that is too long	Hose kit, Part No. 285442
A problem with lint clogging your drain	Drain protector, Part No. 367031

Parts listed are available from your local Sears store or Sears Service Center. In the United States, call 1-800-366-PART (1-800-366-7278). In Canada, call 1-877-533-6937.

For standpipe or laundry tub drain systems:

**STEP 2.** Open yellow, single-wire clamp with pliers and slide over hooked end of drain hose to secure the rubber and corrugated sections together.

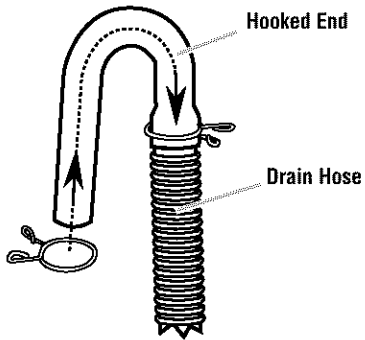

**STEP 3.** Put hooked end of drain hose into laundry tub or standpipe. Check for proper length of drain hose. Rotate hook to eliminate kinks.

To prevent drain water from going back into the washer:

- Do not straighten hooked end of drain hose and force excess drain hose into standpipe.
- Do not lay excess drain hose in bottom of laundry tub.

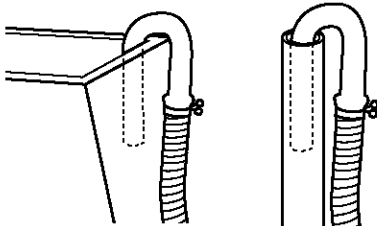

## D. CONNECT INLET HOSES TO WASHER

### **for your Benefit**

Proper connection of your inlet hoses will allow hot and cold water to enter your washer properly. It also helps prevent water damage due to leaks.

**NOTE:** Replace inlet hoses after five years of use to reduce the risk of hose failure. Periodically inspect and replace inlet hoses if bulges, kinks, cuts, wear, or leaks are found. When replacing your inlet hoses, mark the date of replacement on the label with a permanent marker.

**STEP 1.** Insert one new, flat washer (from the parts bag) into each end of the inlet hoses. Check that washers are firmly seated in couplings.

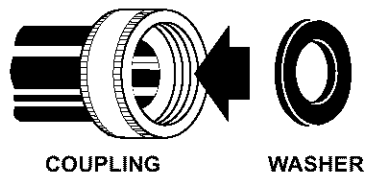



**STEP 2.** Attach the hose with the red coupling to the hot water (bottom) inlet valve. Attaching the red coupling first makes it easier to tighten connection with pliers. Screw on coupling by hand. Make an additional two-thirds turn with pliers to tighten coupling. **DO NOT OVERTIGHTEN;** this could damage the valves.

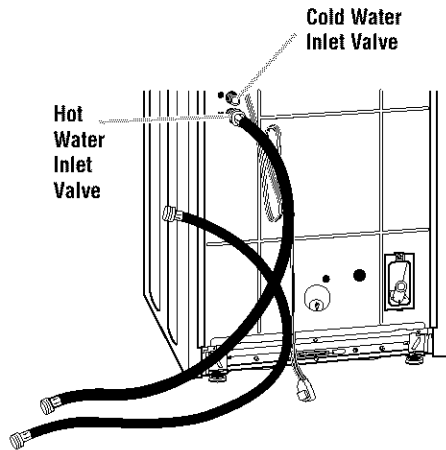

**STEP 3.** Attach the hose with the blue coupling to the cold water (top) inlet valve. Screw on coupling by hand. Make an additional two-thirds turn with pliers to tighten coupling. **DO NOT OVERTIGHTEN;** this could damage valves.

## E. CONNECT INLET HOSES TO WATER FAUCETS

**STEP 1.** Make sure washer basket is empty. Run water through both faucets into a bucket or laundry tub to get rid of particles in the water lines that might clog hoses. Determine which faucet is hot and which is cold. Mark the hot water faucet.

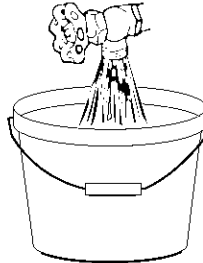

**STEP 2.** Attach the hose with the red coupling to the hot water faucet. Screw on coupling by hand. Make an additional two-thirds turn with pliers to tighten coupling. **DO NOT OVERTIGHTEN;** this could damage the coupling.

**STEP 3.** Attach the hose with the blue coupling to the cold water faucet. Screw on coupling by hand. Make an additional two-thirds turn with pliers to tighten coupling. **DO NOT OVERTIGHTEN;** this could damage the coupling.

**STEP 4.** Turn on water faucets and check for leaks. A small amount of water may enter the washer. You will drain this later.

ENGLISH

If you have:	You will need to buy:
Water faucets beyond the reach of water fill hoses	2 longer water fill hoses: 6 ft (1.8 cm) hoses, Part No. 76314 or 10 ft (3.0 cm) hoses, Part No. 350008

Parts listed are available from your local Sears store or Sears Service Center. In the United States, call 1-800-366-PART (1-800-366-7278). In Canada, call 1-877-533-6937.

## F. SECURE DRAIN HOSE

### *for your* **Benefit**

Securing the drain hose properly will protect your floors from damage due to water leakage.

**STEP 1.** Move washer to its final location.

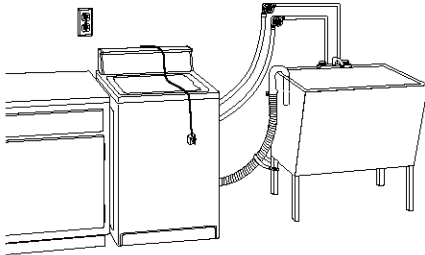

If the water faucets and drain standpipe are recessed, put hooked end of drain hose in standpipe. Tightly wrap the shipping strap around the drain hose and water inlet hoses (not the handles or stems). Push fastener into the nearest hole in the shipping strap.

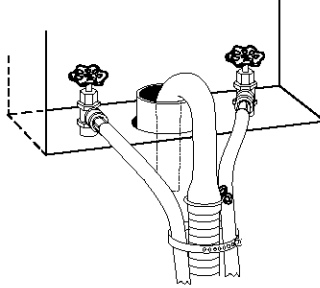

**STEP 2.** Locate the remaining piece of shipping strap (not the end with the cotter pins) from STEP 3 of "REMOVE SHIPPING STRAP." Use it to wrap the drain hose together with the laundry tub or standpipe. Push fastener into the nearest hole in the shipping strap.

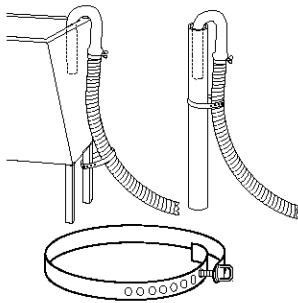

**Fastener**

## G. LEVEL WASHER

### *for your* **Benefit**

Leveling your washer properly prevents excessive noise and vibration.

#### To install front legs:

**STEP 1.** Prop front of washer up (about 4 in [10.2 cm]). Use a wood block or another object that will support the weight of the washer. If washer was placed against a wall, move the washer out slightly before tipping it up.

**STEP 2.** With one of the legs in hand, screw lock nut onto leg  $\frac{3}{8}$  in (9 mm) from top of leg base. This is the recommended initial setting.

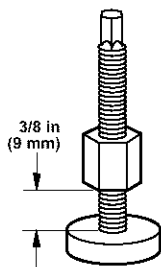

**STEP 3.** Screw leg into washer base by hand until nut reaches washer base. Repeat for other leg.

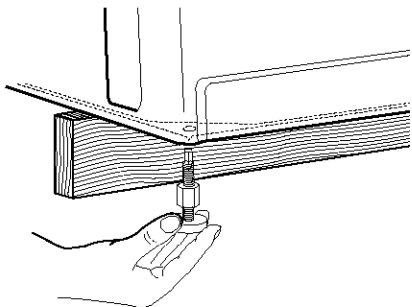

**STEP 4.** Tilt washer backward until front of washer is off the wood block. Remove wood block. Gently lower washer to floor.

**STEP 5.** Move washer to its final location.

**STEP 6.** Tilt washer forward until rear of washer is at least 3 in (7.6 cm) off floor. You may hear the self-adjusting rear legs click into place. Lower washer to floor. Check levelness of the washer by placing a level on top of the washer: first side-to-side, then front-to-back.

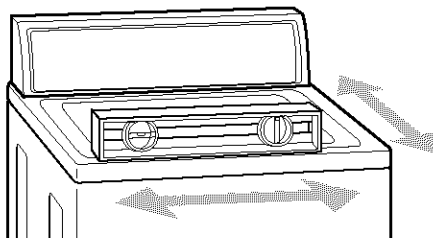

**STEP 7.** If washer is not level, prop up the front of the washer and adjust the legs up or down as necessary. Lower washer and reset self-adjusting rear legs (as in Step 6). Repeat Step 7 until the washer is level.

**STEP 8.** When washer is in its final location and level, use a  $\frac{3}{8}$  in (1.43 cm) open-end wrench to turn nuts on front legs tightly against washer cabinet. If nuts are not tight against washer cabinet, the washer may vibrate.

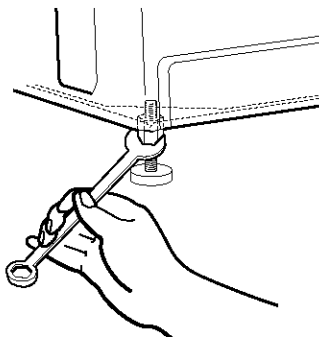

ENGLISH

## REVIEW INSTALLATION

### ***for your* Benefit**

Take a few minutes to complete this checklist. It will help assure you that you have a proper installation and increase your satisfaction with your Kenmore washer.

- Check electrical requirements.  
Be sure you have correct electrical supply and recommended grounding method.
  - Check that you have:
    - All the tools you started with.
    - Removed all packaging materials.
    - Removed shipping strap with cotter pins.
    - Installed all parts listed on pages 7-9.
  - Check that:
    - The washer is level.
    - The nuts on the front legs are tight.
  - Check that the water faucets are turned on.
- 

## FINAL STEPS

- Plug into a grounded 3 prong outlet.
- Remove the blue protective film on the console and any tape remaining on washer.
- Take a few minutes and read the "OPERATING YOUR WASHER" section to fully understand your new washer. Then, start the washer and allow it to complete the REGULAR Cycle.

## OPERATING YOUR WASHER

### *for your* **Benefit**

To get the maximum cleaning and fabric care from your washer, please read and follow these instructions.

**NOTE:** The drawings in this section show the basic features of all models covered by this manual. Refer to the supplied "Feature Sheet" for your washer's particular features.

### **⚠ WARNING**



#### **Fire Hazard**

**Never place items in the washer that are dampened with gasoline or other flammable fluids.**

**No washer can completely remove oil.**

**Do not dry anything that has ever had any type of oil on it (including cooking oils).**

**Doing so can result in death, explosion, or fire.**

ENGLISH

### **LID INSTRUCTIONS**

These instructions are found under the lid of your washer.

#### **OPERATING SUGGESTIONS**

Add measured detergent to the washer basket.

1. SELECT & ADJUST-----Make the selections for these washer controls:

- WATER LEVEL ----- Adjust to load size.
- WASH / RINSE TEMP ----- Selection is based on type of fabric and soil.

2. SELECT CYCLE ----- Choose more time for heavily soiled loads and less time for lightly soiled loads.

3. PULL TIMER TO START ----- Lid must be closed to complete cycle.  
PUSH TIMER TO STOP

**Antiperspirants, Deodorants**

Treat with a paste of ammonia and color-safe bleach. Let stand for 30 minutes. Wash in hottest water safe for fabric.

**Blood**

Rinse immediately or soak in cold water with detergent for 30 minutes. Rinse. Rub detergent into any remaining stains. Rinse thoroughly. Wash.

**Milk, Ice Cream**

Sponge immediately or apply a prewash soil and stain remover. Rinse. Wash. Repeat if necessary. If stain remains, apply a few drops of liquid detergent. Rinse. If stain remains, soak. Wash.

**Grass**

Use an enzyme presoak or rub enzyme detergent on the stain. Launder with detergent and bleach appropriate for the fabric.

**Ketchup, Tomato Products**

Sponge immediately or apply a prewash soil and stain remover. Rinse. Wash. If stain remains, apply a liquid detergent to stain or soak in warm water with detergent. Rewash.

**Mud**

Brush off the dry mud. Rinse under cold water. Pretreat with a paste of detergent and water. Launder using detergent and bleach safe for the fabric.

**STARTING YOUR WASHER**

**STEP 1.** Add measured detergent directly into washer basket. Then place a load of sorted clothes in the washer.

**STEP 2.** Close washer lid.

**STEP 3.** Set WATER LEVEL Control **A** based on the size of your wash load (details on page 23).

**STEP 4.** Push the Cycle Selector Control (Timer) knob **B** in and turn to the right. Set cycle and time according to the type of fabric in the load (details on page 24).

**STEP 5.** Pull the Cycle Selector Control (Timer) knob **B** out. The dial will rotate as the cycle progresses. The knob will not rotate.

**STOPPING/RESTARTING YOUR WASHER**

- To stop the washer at any time, push the Cycle Selector Control (Timer) knob **B** in.
- Pull the knob out to restart.

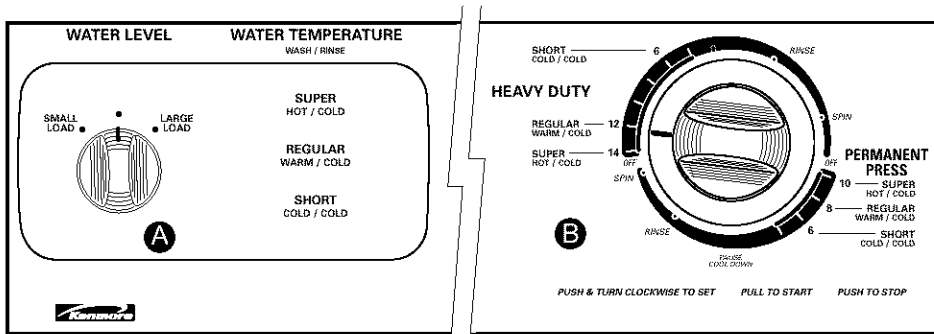

**SET WATER LEVEL CONTROL**

**for your Benefit**

**This control gives you the flexibility to save water when washing small loads.**

Your washer lets you select a water setting based on the size of your wash load.

- For normal loads, start with a medium load. Adjust up or down depending on your load. Clothes should move freely and roll toward the agitator.
- To change to a higher water level setting after the washer has started to agitate, turn the knob to the desired new setting.

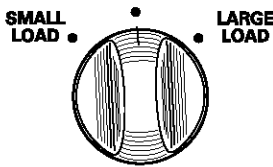

**WASH/RINSE WATER TEMPERATURE**

Your wash/rinse water temperature control is part of the Cycle Selector Control (Timer) knob (see page 24). All rinses are cold to save energy.

- For a HOT water wash, select SUPER.
- For a WARM water wash, select REGULAR.
- For a COLD water wash, select SHORT.

**To select a different wash temperature and cycle (time):**

**STEP 1.** Push in the Cycle Selector Control (Timer) knob and turn clockwise to the desired water temperature.

**STEP 2.** Pull out the Timer knob and allow the washer to fill.

**STEP 3.** When the washer has filled, push in the Timer knob and turn to the desired cycle (time).

**STEP 4.** Pull out the Timer knob.

ENGLISH

SELECTING WATER TEMPERATURES		
Wash Water Temperature	Suggested Fabrics	Comments
HOT 111°F (44°C) or above	<ul style="list-style-type: none"> <li>• Work clothes</li> <li>• Sturdy whites/ colorfast pastels</li> <li>• Diapers</li> </ul>	<ul style="list-style-type: none"> <li>• Best cleaning for heavily soiled items</li> <li>• Removes oils, perspiration, greasy soils and stains</li> <li>• Prevents graying or yellowing</li> </ul>
WARM 90°-110°F (32°-43°C)	<ul style="list-style-type: none"> <li>• Dark/non-colorfast colors</li> <li>• Permanent press items</li> <li>• Nylon, polyester, acrylics, silks, woolens</li> <li>• Knits/delicate fabrics</li> </ul>	<ul style="list-style-type: none"> <li>• Best for moderately soiled to lightly soiled items</li> <li>• Safe for most fabric finishes</li> <li>• Less fading and dye bleeding</li> <li>• Reduces wrinkling</li> </ul>
COLD* 70°-90°F (21°-32°C)	<ul style="list-style-type: none"> <li>• Extra-sensitive colors</li> <li>• Non-colorfast items</li> <li>• Hand washables</li> </ul>	<ul style="list-style-type: none"> <li>• Best for very lightly soiled items</li> <li>• Saves hot water</li> </ul>

\*In wash water temperatures colder than 70°F (21°C), detergents do not dissolve well. Also, soils may be difficult to remove and some fabrics may retain wear wrinkles and have increased pilling – the formation of small lint-like balls on the surface of garments. Pilling is the natural result of wearing and washing of garments.

## SETTING YOUR CYCLE SELECTOR (TIMER) CONTROL

- For sturdy or heavily soiled loads, use SUPER.
- For moderately soiled loads, use REGULAR.
- For delicate or lightly soiled loads, use SHORT.

### HEAVY DUTY

Use this cycle to get up to 14 minutes of wash time. Wash combines fast speed agitation and fast spin speeds.

## PERMANENT PRESS

### *for your* Benefit

The **PERMANENT PRESS** cycle includes a load cooling process that reduces wrinkling compared to other cycles.

Use this cycle to get up to 10 minutes of wash time. Wash combines fast speed agitation and fast spin speeds.

**NOTE:** When the timer reaches PAUSE, the washer will drain and pause for no more than two minutes while some of the wash water is replaced with rinse water.

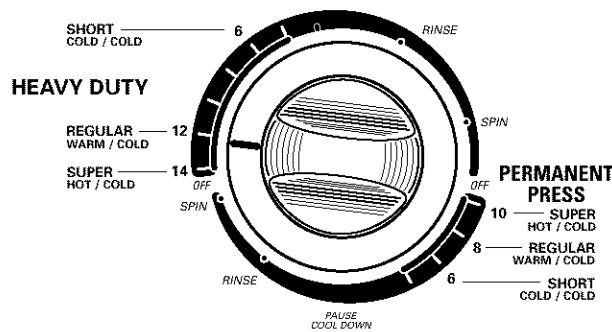

### RINSE AND SPIN

When using extra detergent for heavily soiled clothes, or washing special-care items, you may find an extra rinse and spin is needed.

**STEP 1.** Set WATER LEVEL Control.

**STEP 2.** Set the Cycle Selector Control (Timer) knob to the RINSE setting.

**STEP 3.** Pull Cycle Selector Control (Timer) knob out to start washer.

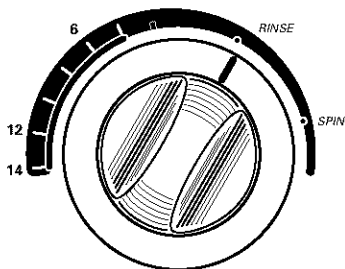

### SPIN ONLY

A drain and spin may help shorten drying times for some heavy fabrics or special-care items by removing excess water.

**STEP 1.** Set the Cycle Selector Control (Timer) knob to the SPIN setting.

**STEP 2.** Pull the Cycle Selector Control (Timer) knob out to start washer.

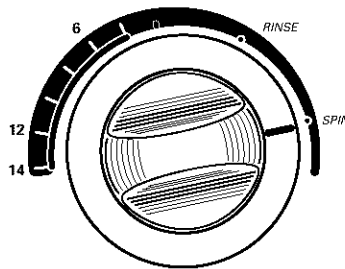



**UNDERSTANDING WHAT HAPPENS DURING THE WASHER CYCLE**

**HEAVY DUTY**

	Fill to selected level
	Wash selected time
	Drain – no spin
	Spin
	Fill to selected level
	Rinse
	Drain – no spin
	Spin
	Off

**PERMANENT PRESS**

	Fill to selected level
	Wash selected time
	Partial Drain
	Pause
	Fill for cool down
	Wash
	Drain – no spin
	Spin
	Fill to selected level
	Rinse
	Drain – no spin
	Spin
	Off

ENGLISH

## DUAL ACTION® AGITATOR

**for your Benefit**

**Kenmore's DUAL ACTION® Agitator gives you flexible fabric care for even your largest loads.**

The best cleaning action in your washer takes place at the bottom where the agitator vanes move back and forth to flex the fabric, loosening the soil. To get all your clothes down to the bottom of the washer, the upper portion of the agitator has uniquely designed, spiral vanes to help push the clothes that are on top down to the bottom. This spiraling action displaces the clothes that are on the bottom with a "roll-over" motion.

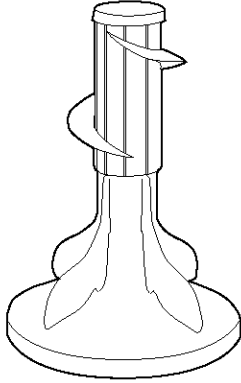

## UNDERSTANDING NORMAL WASHER SOUNDS

Your new washer may make sounds that your old one didn't. Because the sounds are unfamiliar, you may be concerned about them.

The following describes some of the normal sounds you may hear and what causes them.

### **During Drain**

The rate that water is drained from your washer depends on your installation. If water is drained quickly from the washer, you may hear air being pulled through the pump. This happens during the end of draining.

### **After Drain and Before Spin**

When the cycle changes from draining to spinning, you may hear a noise as the gearcase shifts.

## SELF-CLEANING LINT FILTER

**for your Benefit**

**Lint is filtered from the load automatically – there's no messy cleanup.**

Your washer features a self-cleaning filter that traps lint from the water while the washer is washing and deep rinsing the laundry. The trapped lint is flushed down the drain automatically. You don't have to clean the filter.

## LAUNDRY TIPS

### PREPARING CLOTHES FOR WASHING

#### *for your* **Benefit**

Follow these recommendations to help you prolong the life of your garments.

- Close zippers, snaps, and hooks to avoid snagging other items. Remove pins, buckles, and other hard objects to avoid scratching the washer interior. Remove non-washable trim and ornaments.
- Empty pockets and turn them inside out.
- Turn down cuffs, brush away lint and dirt.
- Turn synthetic knits inside out to avoid pilling.
- Tie strings and sashes so they will not tangle.
- Mend tears, loose hems, and seams.
- Treat spots and stains.
- Stained or wet garments should be washed promptly for best results.

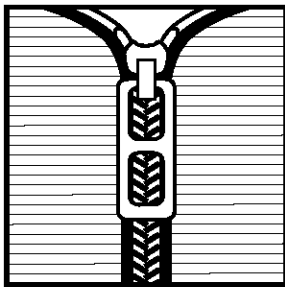

### SORTING

- Separate heavily soiled items from lightly soiled ones, even if they would normally be washed together. Separate lint givers (towels, chenille) from lint takers (corduroy, synthetics, permanent press). When possible, turn lint givers inside out.
- Separate dark colors from light colors, colorfast items from non-colorfast items.
- Sort by fabric and construction (sturdy cottons, knits, delicate items).

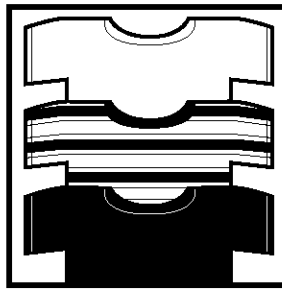

ENGLISH

**LOADING**

**for your Benefit**

Proper loading of your washer contributes to proper cleaning and fabric care and reduces machine noise.

- Drop items into washer loosely. Fill to the top of the basket (top row of holes). Do not wrap items around the agitator. Items should move easily through wash water for best cleaning and wrinkle-free results. Items should sink and reappear later.
- Load washer properly and select correct water level setting. Overloading or packing the machine, and selecting a setting too small for the wash load can:
  - cause poor cleaning
  - increase wrinkling
  - create excessive lint
  - wear out items faster (because of pilling)
- Load by the amount of space items take up, not by their weight.
- Mix large and small items in each load. Load evenly to maintain washer balance. An off-balance load can make the washer vibrate during spin.
- Use a higher water level setting to reduce wrinkling with permanent press clothes and some synthetic knits. These items should have more room to move in the water than heavy items (towels, jeans).

- Reduce wash time by using a lower water level setting. Loads with only a few small items need less wash time.

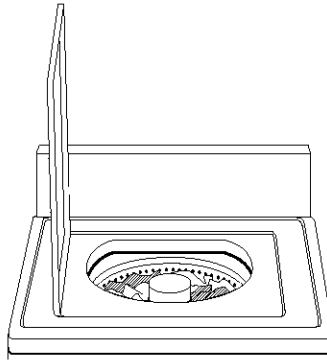

**LOADING SUGGESTIONS**

For these suggested full-sized loads, set the WATER LEVEL selector to the highest water level setting.

<b>EXTRA LARGE CAPACITY PLUS WASHERS</b>		
<b>Heavy Work Clothes</b>	<b>Towels</b>	<b>Mixed Load</b>
3 jeans	7 bath towels	2 sheets
3 workpants	8 hand towels	(1 king, 1 twin)
2 workshirts	9 wash cloths	2 pillowcases
1 sweatshirt		2 shirts
1 sweatpants		2 blouses
		6 T-shirts
		5 shorts
		6 handkerchiefs

## CARING FOR YOUR WASHER

### CLEANING YOUR WASHER

#### Exterior

Wipe up detergent, bleach, and other spills with a soft, damp cloth or sponge as they occur. Occasionally wipe the outside of the washer to keep it looking like new.

Do not put sharp or metal objects in your washer. They can damage the finish. Check all pockets for pins, clips, money, bolts, nuts, etc. Do not lay these objects on your washer after emptying pockets.

#### Interior

Clean interior with 1 cup (250 mL) of chlorine bleach mixed with 2 cups (500 mL) of detergent. Run washer through a complete cycle using hot water. Repeat process if necessary.

**NOTE:** Remove hard water deposits using only cleaners labeled as washer safe.

### WATER INLET HOSES

Replace inlet hoses after five years of use to reduce the risk of hose failure. Periodically inspect and replace inlet hoses if bulges, kinks, cuts, wear, or leaks are found. When replacing your inlet hoses, mark the date of replacement on the label with a permanent marker.

### WINTER STORAGE OR MOVING CARE

Install and store your washer where it will not freeze. Because some water may stay in the hoses, freezing can damage your washer. If storing or moving your washer during freezing weather, winterize it.

#### To winterize washer:

1. Shut off both water faucets.
2. Disconnect and drain water inlet hoses.
3. Put 1 qt (1 L) of R.V.-type antifreeze in the basket.
4. Run washer on a SPIN setting for about 30 seconds to mix the antifreeze and water. Some of the mixture will pump out while the washer spins.
5. Unplug washer or disconnect power.

#### To use washer again:

1. Flush water pipes and hoses.
2. Reconnect water inlet hoses.
3. Turn on both water faucets.
4. Plug in washer or reconnect power.
5. Run the washer through a complete cycle with 1 cup (250 mL) of detergent to clean out antifreeze.

### NON-USE OR VACATION CARE

Operate your washer only when you are at home. If you will be on vacation or not using your washer for an extended period of time, you should:

- Unplug washer or disconnect power.
- Turn off the water supply to the washer. This helps avoid accidental flooding (due to a water pressure surge) while you are away.

ENGLISH

## TROUBLESHOOTING

**Most laundering problems are easily solved if you understand the cause. Check these lists for common laundry and washer problems. If you need further assistance, see service and assistance information on back cover.**

Problem	Possible Cause	Solution
<b>Washer Leaks</b>	Household plumbing is leaking.	Repair plumbing.
	Inlet hoses not tight.	Tighten hoses (see "Installation Instructions," Sections D & E).
	Inlet hose washers not properly seated.	Reseat washers (see "Installation Instructions," Section D).
	Drain hose not properly clamped or is off.	Clamp drain hose (see "Installation Instructions," Section C).
	Drain is clogged.	Remove drain clogs. Sink, standpipe, or floor drain must be able to handle 17 gal (64 L) of water per minute.
	Tub moved forward during unloading, causing water to deflect off tub ring.	Ensure tub is centered before starting washer.
	Unit not level causing water to deflect off tub ring.	Ensure front feet are installed and nuts are tightened. Level washer. Reset rear legs (see "Installation Instructions," Section G).
	Load is unbalanced. Spray rinses are deflecting off load.	Redistribute the load.
<b>Won't Drain/ Won't Spin/ Wet Loads</b>	Washer is overloaded. Fills or spray rinses are deflecting off load.	Reduce load size.
	Drain hose is kinked or clogged.	Straighten or unplug hose (see "Installation Instructions," Section C).
	Correct operation of neutral drain.	After a wash or rinse, the washer will drain without spinning. After draining, the spinning begins.
	Lid is open.	Close the lid.
	Drain hose is more than 96 in (2.4 m) above the floor.	Lower drain hose (see "Installation Instructions," Section C).
	Too much detergent – excessive sudsing.	Use less detergent.
	Low voltage or using an extension cord.	Check electrical source or call electrician. Do not use extension cords.
Cold rinses.	Cold rinses leave loads wetter than warm rinses. This is normal.	

<b>Problem</b>	<b>Possible Cause</b>	<b>Solution</b>
<b>Continues to Fill/ Continues to Drain/ Cycle Stuck</b>	Drain hose is less than 39 in (99 cm) above floor.	Raise the drain hose (see "Installation Instructions," Section C).
	Drain hose fits tightly into standpipe.	Adjust drain hose for loose fit (see "Installation Instructions," Section C).
	Drain hose taped into standpipe.	Do not seal off drain hose with tape. The drain hose needs an air gap.
<b>Washer Makes Noise</b>	Load is unbalanced.	Redistribute load.
	Washer is not level. Rear leveling legs not set.	Level washer. Reset rear legs (see "Installation Instructions," Section G).
	Nuts on front feet not tight.	Tighten nuts (see "Installation Instructions," Section G).
	Yellow shipping strap with cotter pins not completely removed.	Remove strap with cotter pins (see "Installation Instructions," Section B).
	Floor not strong enough to support washer.	Relocate washer (see "Installation Instructions," Section A).
	Gears engaging after drain and before spin.	This is normal.
	Upper part of agitator clicks during wash.	This is normal.
<b>Won't Fill/Won't Rinse/Won't Agitate/ Wrong Temperature</b>	Water inlet valve screens are plugged.	Clean screens.
	Water is turned off.	Turn on water.
	Hot and cold hoses are reversed.	Reverse hoses (see "Installation Instructions," Sections D & E).
	Inlet hose is kinked.	Straighten hoses.
	Timer dial is not lined up.	Turn timer knob to the right slightly and pull to start.
	Power cord not plugged in.	Plug into a grounded 3 prong outlet.

<b>Problem</b>	<b>Possible Cause</b>	<b>Solution</b>
<b>Machine Stops</b>	Power cord not plugged in.	Plug into a grounded 3 prong outlet.
	No power at plug.	Check electrical source or call electrician.
	Fuse blown or circuit breaker open.	Replace fuse or reset circuit breaker. If problem continues, call electrician.
	Using an extension cord.	Do not use extension cords.
	Timer is not lined up.	Turn timer to the right slightly and pull to start.
	Timer knob not pulled out.	Set and pull out knob.
	Machine is overloaded.	Wash smaller loads.
<b>Agitator Not Working</b>	The top of the agitator moves only in one direction.	This is normal.
	The top of the agitator is loose.	This is normal.
<b>Water Level Too Low/Not Completely Filling</b>	The top of the agitator is much higher than the highest water level. This creates a perception of the washer not being full.	This is normal.
<b>Tub is Crooked</b>	Tub pulled forward when unloading.	Ensure tub is centered before starting washer.
	Tub moves.	This is normal.
	Unit not level.	Ensure front feet are installed and nuts are tightened. Level washer. Reset rear legs (see "Installation Instructions," Section G).
<b>Lint on Load</b>	Improper sorting.	Sort lint givers from lint takers and by color.
	Overloading.	Lint can be trapped in load if overloaded. Wash smaller loads.
	Paper or tissue in pockets.	Clean out pockets before washing.
	Not enough detergent.	Use enough detergent to hold lint in water.
	Detergent not dissolving. Water temperature lower than 70°F (21°C).	Use wash water warmer than 70°F (21°C).



<b>Problem</b>	<b>Possible Cause</b>	<b>Solution</b>
<b>Tearing</b>	Overloading. Improper use of washer.	Loads should move freely during wash. Wash smaller loads.
	Improper use of chlorine bleach. Undiluted bleach will damage fabrics.	Do not pour chlorine bleach directly on load. Wipe up bleach spills.
	Sharp items not removed from pockets; fasteners not fastened.	Clean out pockets before washing. Zip zippers before washing.
	Items damaged before washing.	Mend rips and broken threads in seams before washing.
<b>Stains on Load</b>	Improper use of fabric softener in washer or dryer.	Dilute fabric softener and add to deep rinse only.
	Iron in water (rust).	Install an iron filter.
	Under use of detergent causing soil to be redeposited.	Use enough detergent to remove soil and hold it in suspension.
	Dye transfer due to not sorting loads properly.	Sort dark clothing from whites and lights.
	Dye transfer due to not unloading washer promptly.	Unload the washer as soon as it stops.
<b>Load is Wrinkled</b>	Not removing load promptly.	Unload the washer as soon as it stops.
	Overloading.	Loads should move freely during wash. Wash smaller loads.
	Hoses reversed.	Reverse hoses (see "Installation Instructions," Sections D & E).
<b>Load is Tangled/ Twisted</b>	Overloading.	Loads should move freely during wash. Wash smaller loads.
	Clothes wrapped around agitator.	Do not wrap items around agitator when loading the washer.

## SEARS MAINTENANCE AGREEMENT

### **KENMORE WASHERS**

"We Service What We Sell" is our assurance you can depend on Sears for service. Your Kenmore appliance has added value when you consider that Sears has service units nationwide, staffed with professional technicians trained on all appliances Sears sells. They have the knowledge and skills, tools, parts and equipment to ensure our pledge to you that "We Service What We Sell."

Maintain the value of your purchase with a Sears Maintenance Agreement. Kenmore appliances are designed, manufactured and tested for years of dependable operation. Yet any major appliance may require service from time to time. The Sears Maintenance Agreement offers you an outstanding service program for your product.

#### **The Sears Maintenance Agreement**

- Is your way to buy tomorrow's service at today's prices.
- Eliminates repair bills resulting from normal use.
- Allows for as many service calls as required.
- Provides an annual Preventive Maintenance Check at your request to keep your Kenmore appliance in proper running condition.

**For more information, call  
1-800-827-6655 (USA) or  
1-877-533-6937 (Canada)**

# Get it fixed, at your home or ours!

For repair of major brand appliances **in your own home...**  
no matter who made it, no matter who sold it!

**1-800-4-MY-HOME<sup>SM</sup>** Anytime, day or night  
(1-800-469-4663)

[www.sears.com](http://www.sears.com)

To bring in products such as vacuums, lawn equipment and electronics  
for repair, call for the location of your nearest **Sears Parts & Repair Center**

**1-800-488-1222** Anytime, day or night

[www.sears.com](http://www.sears.com)

For the replacement parts, accessories and owner's manuals  
that you need to do-it-yourself, call **Sears PartsDirect<sup>SM</sup>**!

**1-800-366-PART** 6 a.m. – 11 p.m. CST,  
(1-800-366-7278) 7 days a week

[www.sears.com/partsdirect](http://www.sears.com/partsdirect)

To purchase or inquire about a Sears Service Agreement:

**1-800-827-6655**

7 a.m. – 5 p.m. CST, Mon. – Sat.

Para pedir servicio de reparación a domicilio,  
y para ordenar piezas con entrega a domicilio:  
**1-888-SU-HOGAR<sup>SM</sup>**  
(1-888-784-6427)

Au Canada pour service en français:  
**1-877-LE-FOYER<sup>SM</sup>**  
(1-877-533-6937)

**SEARS**  
HomeCentral