

90±1
86±1

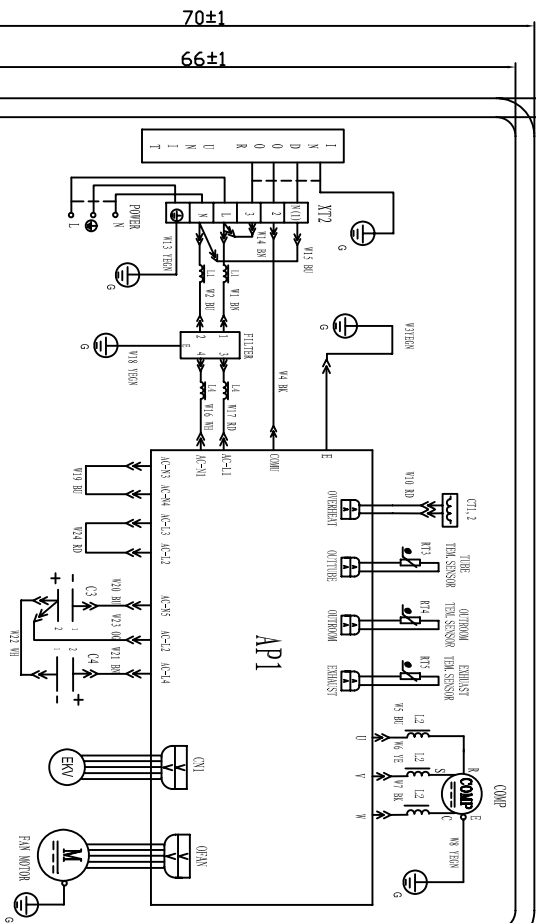

70±1

66±1